

2835A03-XXH05-2P-F10-LX Datasheet

This 2835 LED Light Source is a high performance energy efficient device which can handle high thermal and high driving current. The small package outline and high intensity make it an ideal choice for LED panel light, LED bulb light, LED tube light, backlighting and etc.

The White Power LED is available in the range of color temperature from 2600K to 7000K.

This part has a foot print that is compatible to most of the same size LED in the market today.



FEATURES

- Available in Cool White, Neutral White and Warm White color
- ERP-compatible chromaticity bins
- High luminous Intensity and high efficiency
- Compatible with reflow soldering process
- Low thermal resistance
- Long operation life
- Wide viewing angle at 120°
- Silicone encapsulation
- Environmental friendly, RoHS compliance

APPLICATIONS

- Flat panel light
- LED tube light
- LED bulb light
- Decorative and landscape lighting
- Signage and channel letter
- Reading lamp
- Decorating and entertainment lighting
- Architectural lighting

Note: The information in this document is subject to change without notice.

PACKAGE DIMENSIONS

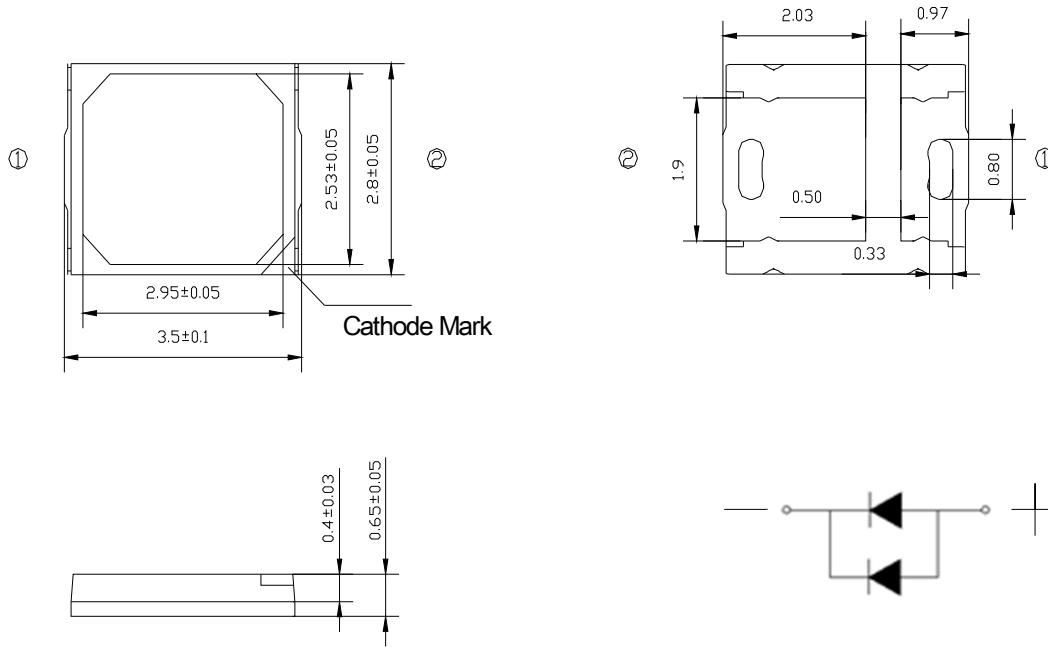

Recommended Solder Pad Design

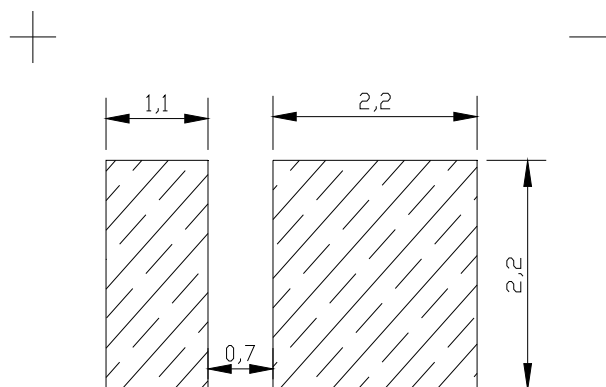

Notes:

1. All dimensions in millimeters.
2. Thickness tolerance of copper plate is ± 0.02 mm.
3. Thickness tolerance of product is ± 0.05 mm.
4. Tolerance is ± 0.1 mm unless otherwise noted.

ABSOLUTE MAXIMUM RATINGS

| Item | Symbol | Absolute Maximum Rating | Unit |
|-------------------------------------|-----------|--|------|
| Forward current | I_F | 300 | mA |
| Peak Forward Current ^[1] | I_{FP} | 300 | mA |
| Reverse Voltage | V_R | 5 | V |
| Power Dissipation | P_d | 500 | mW |
| Operating Temperature | T_{opr} | -40~+85 | °C |
| Storage Temperature | T_{stg} | -40~+100 | °C |
| Soldering Temperature | T_{sld} | Reflow Soldering: 260°C for 10 seconds | |
| LED Junction Temperature | T_j | 125 | °C |

Note:

I_{FP} Conditions: Pulse Width ≤ 10 msec. and Duty $\leq 1/10$.

CHARACTERISTICS ($T_j=25^\circ\text{C}$)

| Parameter | Symbol | Condition | Min | Typ | Max | Unit |
|--|-----------------|--------------------|------|-----|------|------|
| Forward Voltage ^[1] | V_F | $I_F=150\text{mA}$ | 2.8 | -- | 3.1 | V |
| Viewing Angle | $2\theta_{1/2}$ | $I_F=150\text{mA}$ | -- | 120 | -- | deg. |
| Luminous Flux | Φ_v | $I_F=150\text{mA}$ | 65 | -- | 78 | lm |
| Color Rendering Index | CRI | $I_F=150\text{mA}$ | 80 | -- | -- | -- |
| Color Temperature | CCT | $I_F=150\text{mA}$ | 2600 | -- | 7000 | K |
| Thermal Resistance (Junction to Solder Point) | R_{th-js} | $I_F=150\text{mA}$ | -- | 20 | -- | °C/W |

Notes:

- Luminous flux is measured with an accuracy of $\pm 10\%$.
- Chromaticity coordinate bins are measured with an accuracy of ± 0.01 .
- CRI is measured with an accuracy of ± 2 ;
- Some color and CRI bins may have limited availability, please contact us before ordering.
- All measurements were made under the standardized environment of Shineon

RELATIVE SPECTRAL POWER DISTRIBUTION ($T_j=25^\circ\text{C}$)

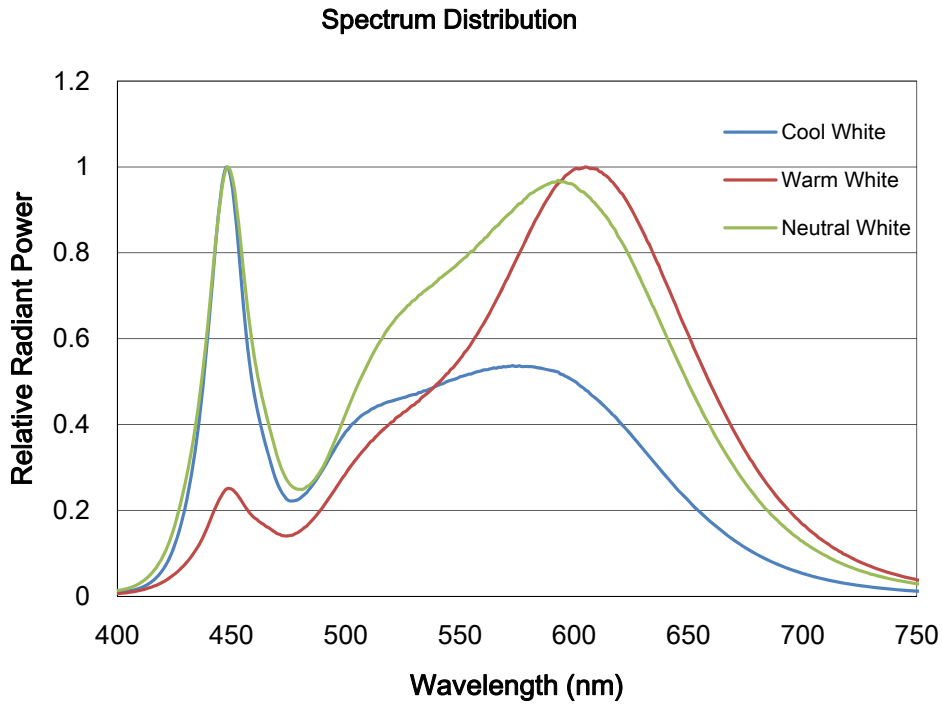

TYPICAL SPATIAL DISTRIBUTION

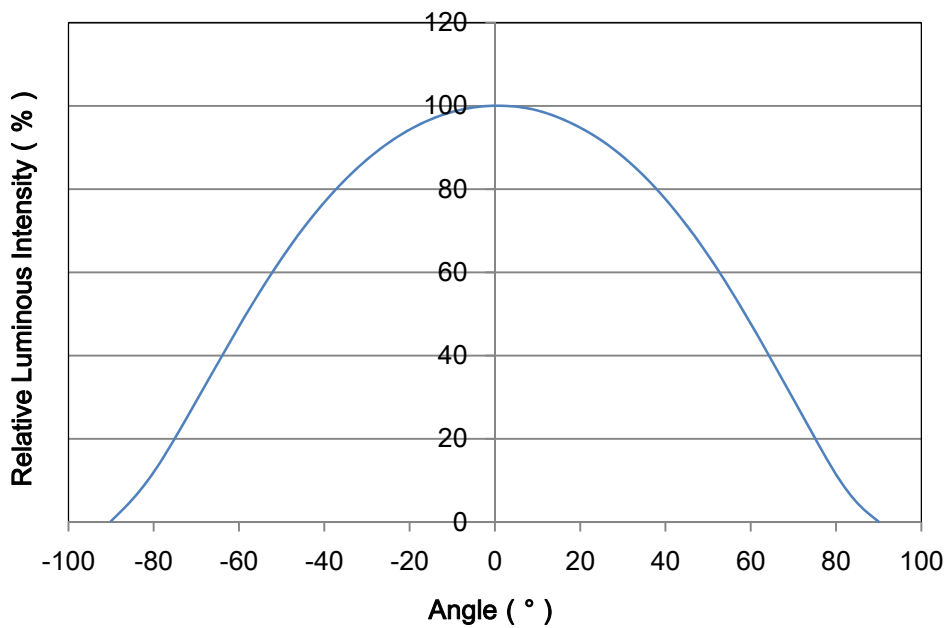

RELATIVE LUMINOUS FLUX VS. CURRENT ($T_j=25^\circ\text{C}$)

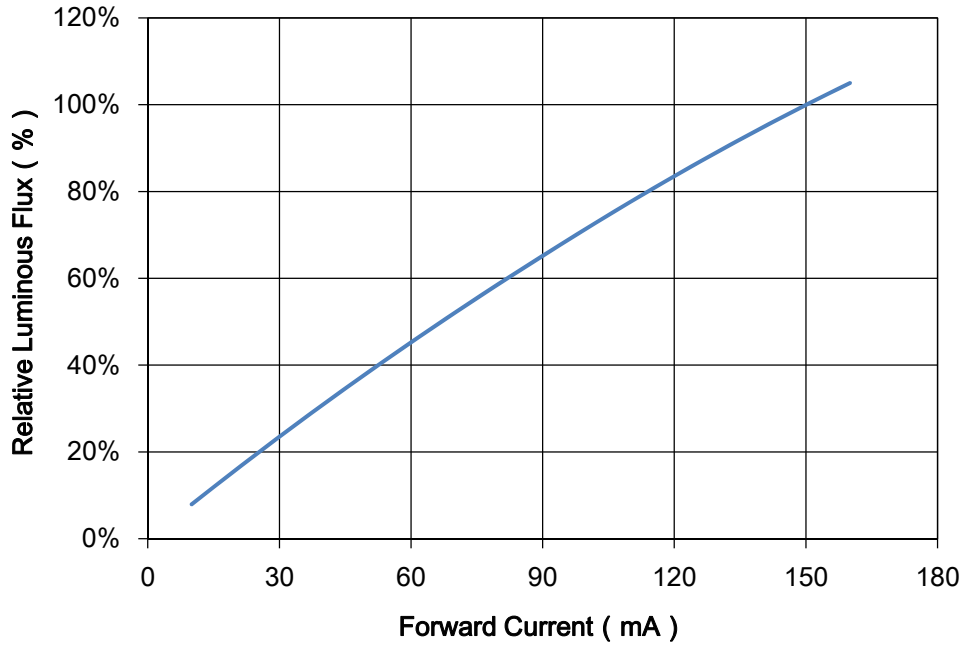

ELECTRICAL CHARACTERISTICS ($T_j=25^\circ\text{C}$)

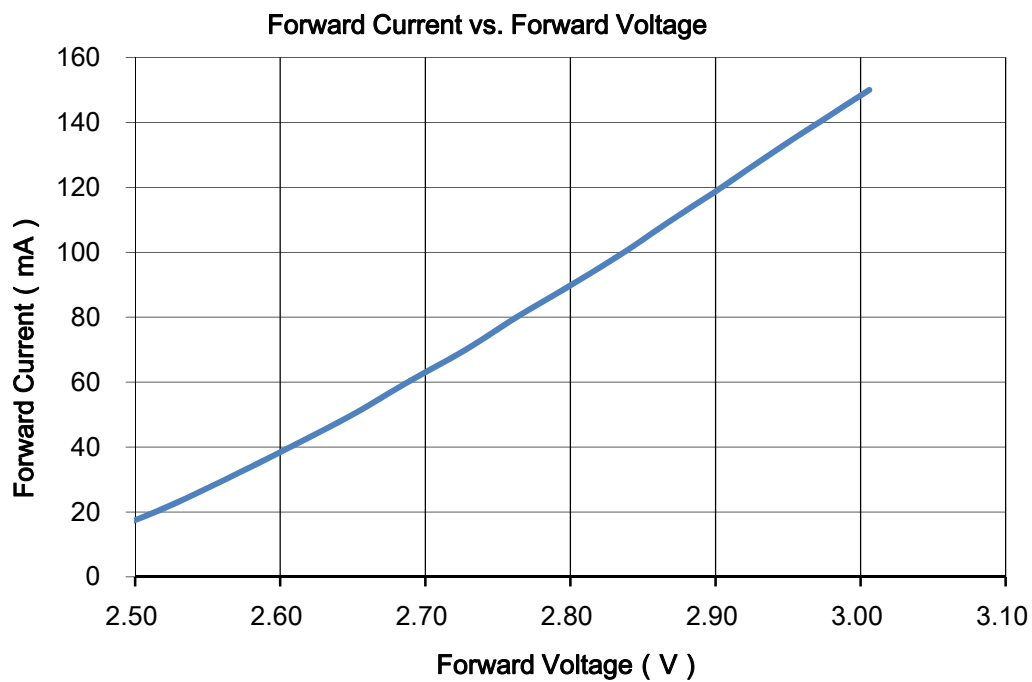

MAXIMUM CURRENT VS. AMBIENT TEMPERATURE

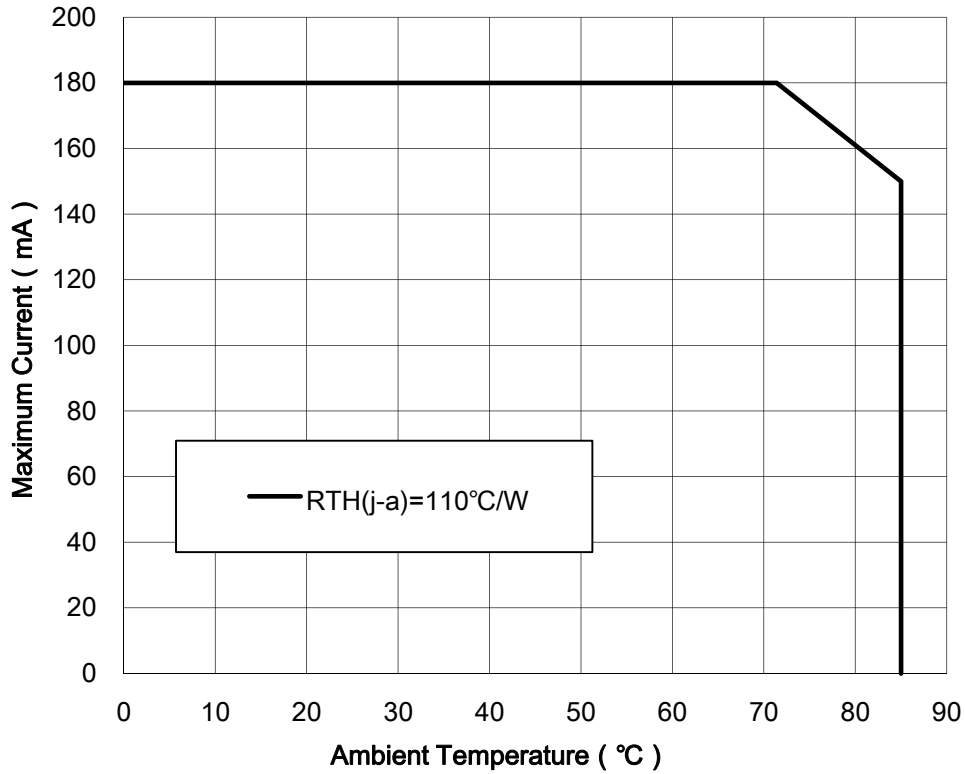

RELATIVE RADIANT FLUX VS. JUNCTION TEMPERATURE

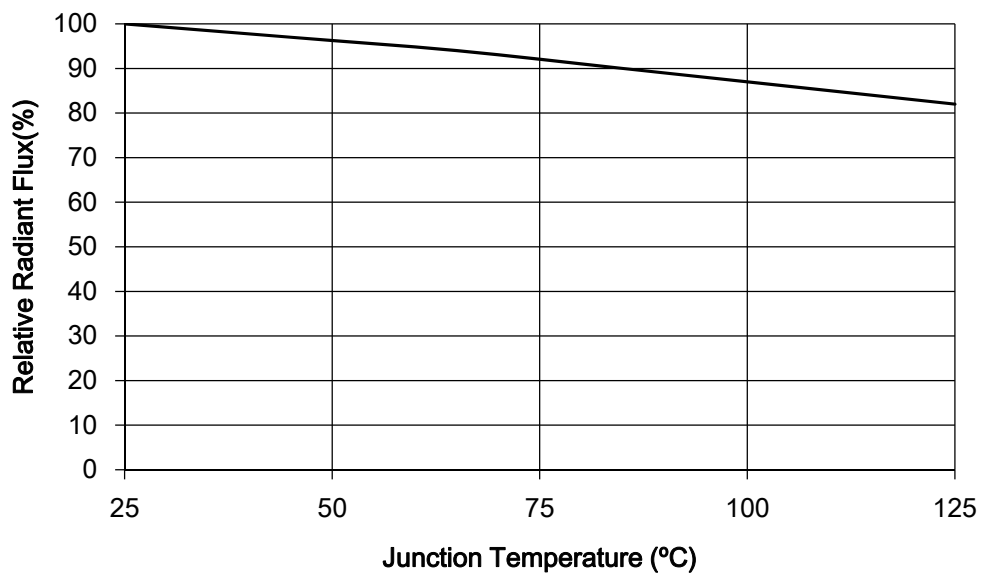

SORTING RANKS
(1) Luminous Flux (T_j=25°C)

| Part Number | Condition | Rank | Unit |
|-------------------------|-----------|-------|------|
| 2835A03-27H05-2P-F10-LX | 150mA | P3 | lm |
| | | 65-70 | |
| 2835A03-30H05-2P-F10-LX | | P33 | |
| | | 68-73 | |
| 2835A03-40H05-2P-F10-LX | | P43 | |
| | | 73-78 | |
| 2835A03-50H05-2P-F10-LX | | P43 | |
| | | 73-78 | |
| 2835A03-57H05-2P-F10-LX | | P43 | |
| | | 73-78 | |
| 2835A03-65H05-2P-F10-LX | | P40 | |
| | | 73-78 | |

(2) Forward Voltage (T_j=25°C)

| Rank | Condition | Min. | Max. | Unit |
|------|-----------|------|------|------|
| A8 | 150mA | 2.8 | 2.9 | V |
| A9 | | 2.9 | 3.0 | |
| B0 | | 3.0 | 3.1 | |

Notes:

1. 10% tolerance for luminous intensity may be caused by measurement inaccuracy.
2. Measurement Uncertainty of the Forward Voltage : ± 0.05V

(3) Chromaticity Bins

| | | | | | |
|-------------|-------------------------|--------|---------|---------|--------|
| Part Number | 2835A03-27H05-2P-F10-LX | | | CCT | 2700K |
| Bin Code | Color Coordinates (X,Y) | | | | |
| A27-5 | x | y | a | b | Theta° |
| | 0.4578 | 0.4101 | 0.01290 | 0.00685 | 57.283 |

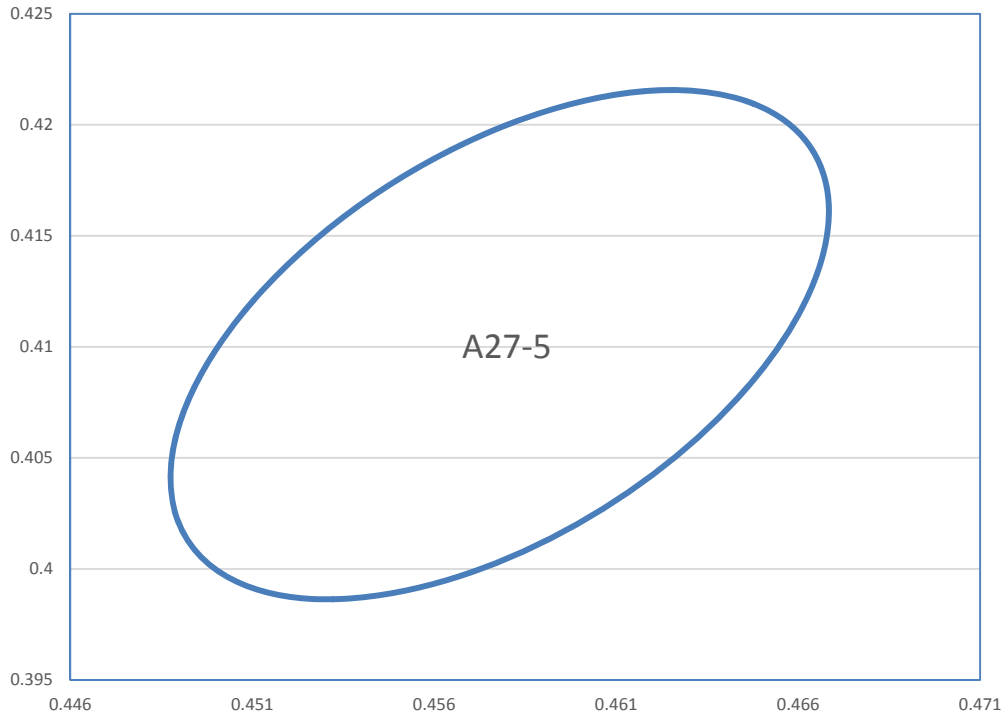

| | | | | | |
|-------------|-------------------------|-------|---------|---------|--------|
| Part Number | 2835A03-30H05-2P-F10-LX | | | CCT | 3000K |
| Bin Code | Color Coordinates (X,Y) | | | | |
| A30-5 | x | y | a | b | Theta° |
| | 0.4338 | 0.403 | 0.01390 | 0.00680 | 53.167 |

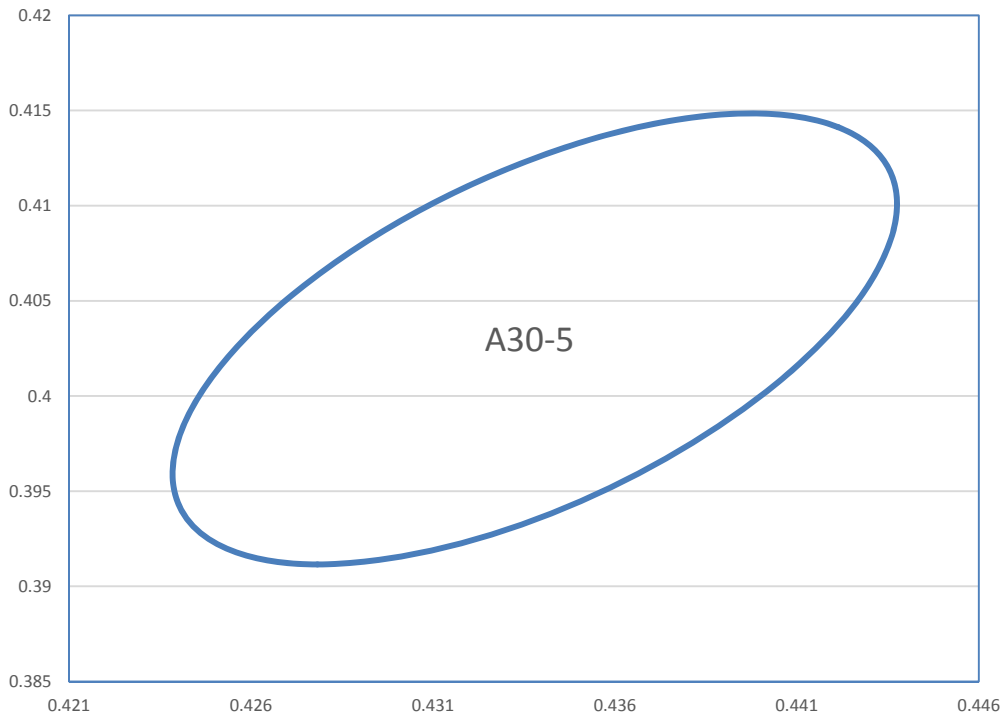

| | | | | | |
|-------------|-------------------------|--------|---------|---------|--------|
| Part Number | 2835A03-40H05-2P-F10-LX | | | CCT | 4000K |
| Bin Code | Color Coordinates (X,Y) | | | | |
| A40-5 | x | y | a | b | Theta° |
| | 0.3818 | 0.3797 | 0.01565 | 0.00670 | 54 |

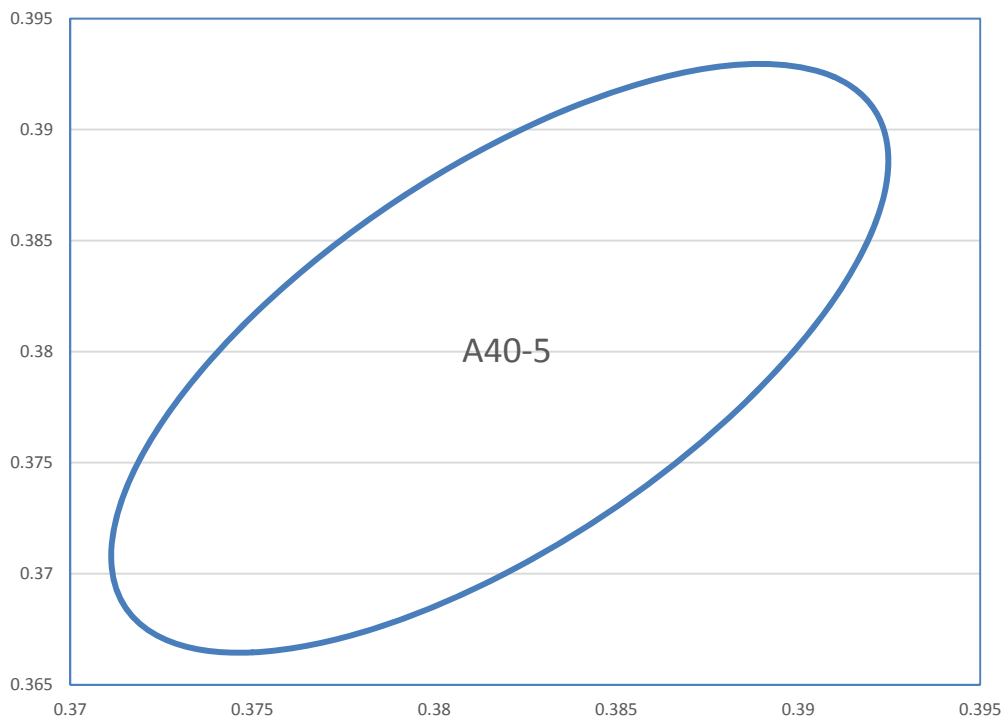

| | | | | | |
|-------------|-------------------------|--------|---------|---------|--------|
| Part Number | 2835A03-50H05-2P-F10-LX | | | CCT | 5000K |
| Bin Code | Color Coordinates (X,Y) | | | | |
| A50-5 | x | y | a | b | Theta° |
| | 0.3447 | 0.3553 | 0.01370 | 0.00590 | 59.617 |

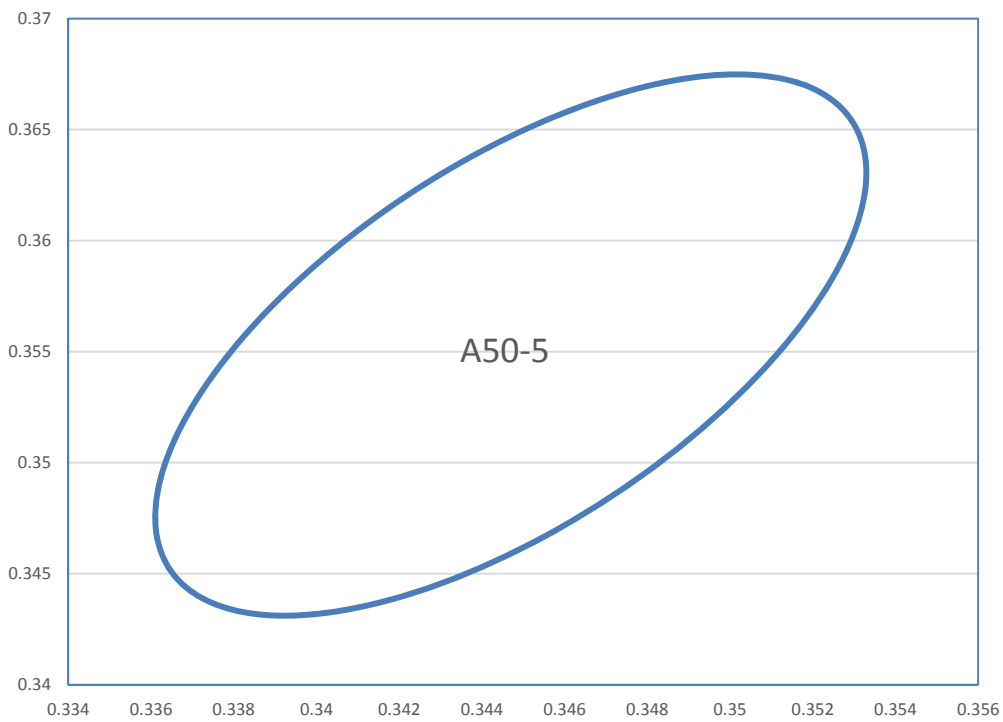

| | | | | | |
|-------------|-------------------------|--------|---------|---------|--------|
| Part Number | 2835A03-57H05-2P-F10-LX | | | CCT | 5700K |
| Bin Code | Color Coordinates (X,Y) | | | | |
| A57-5 | x | y | a | b | Theta° |
| | 0.3287 | 0.3417 | 0.01245 | 0.00535 | 59.09 |

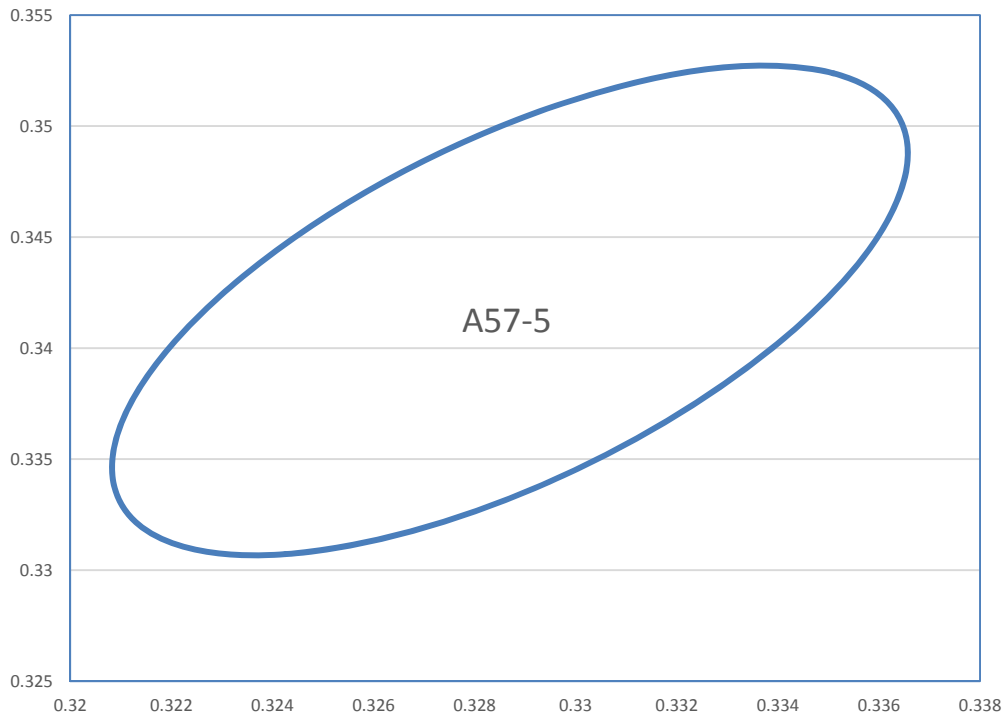

| | | | | | |
|-------------|-------------------------|--------|---------|---------|--------|
| Part Number | 2835A03-65H05-2P-F10-LX | | | CCT | 6500K |
| Bin Code | Color Coordinates (X,Y) | | | | |
| A65-5 | x | y | a | b | Theta° |
| | 0.3123 | 0.3282 | 0.01115 | 0.00475 | 58.383 |

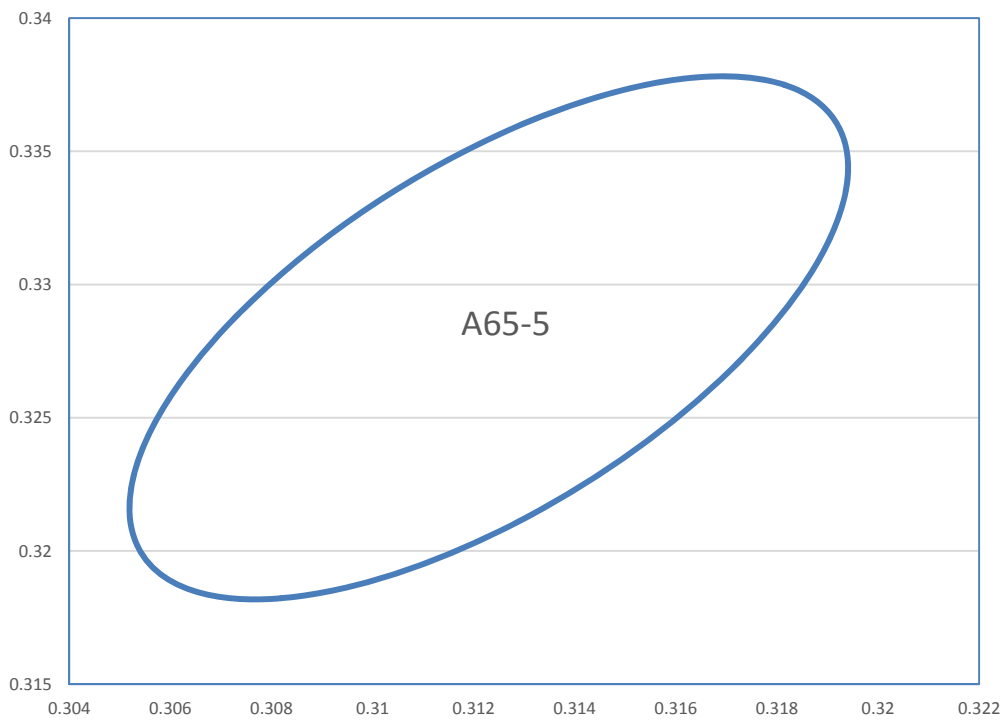

REFLOW SOLDERING CHARACTERISTICS

For Reflow Process:

Preheating : 140°C~160°C±5°C, within 2 minutes.

Operation heating : 260°C(Max.) within 10 seconds.(Max)

Gradual Cooling (Avoid quenching).

| Lead solder | | Lead-free solder | |
|--------------------------|--------------|--------------------------|--------------|
| Pre-heat | 120-150°C | Pre-heat | 150-200°C |
| Pre-heat time | 120 sec.Max. | Pre-heat time | 120 sec.Max. |
| Peak Temperature | 240°C Max. | Peak Temperature | 260°C Max. |
| Soldering time condition | 10 sec.Max. | Soldering time condition | 10 sec.Max. |

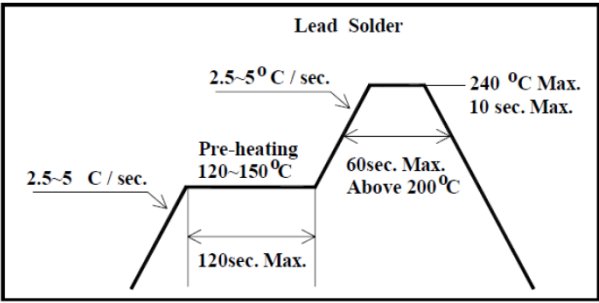
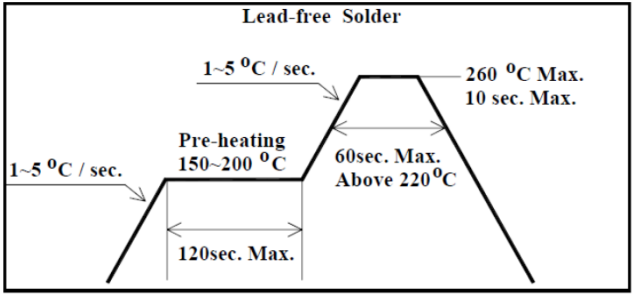
| Lead Solder | Lead-free Solder |
|--|--|
|  <p>The diagram for Lead Solder shows a reflow profile with the following parameters: heating rate of 2.5-5°C/sec, pre-heating at 120-150°C for 120 sec. Max., heating rate of 2.5-5°C/sec to a peak of 240°C Max. for 10 sec. Max., and a dwell time of 60 sec. Max. above 200°C.</p> |  <p>The diagram for Lead-free Solder shows a reflow profile with the following parameters: heating rate of 1-5°C/sec, pre-heating at 150-200°C for 120 sec. Max., heating rate of 1-5°C/sec to a peak of 260°C Max. for 10 sec. Max., and a dwell time of 60 sec. Max. above 220°C.</p> |

Notes:

The encapsulated material of the LEDs is silicone . Therefore the LEDs have a soft surface on the top of package. The pressure to the top surface will be influence to the reliability of the LEDs. Precautions should be taken to avoid the strong pressure on the encapsulated part. So when using the picking up nozzle, the pressure on the silicone resin should be proper.

TAPE AND REEL

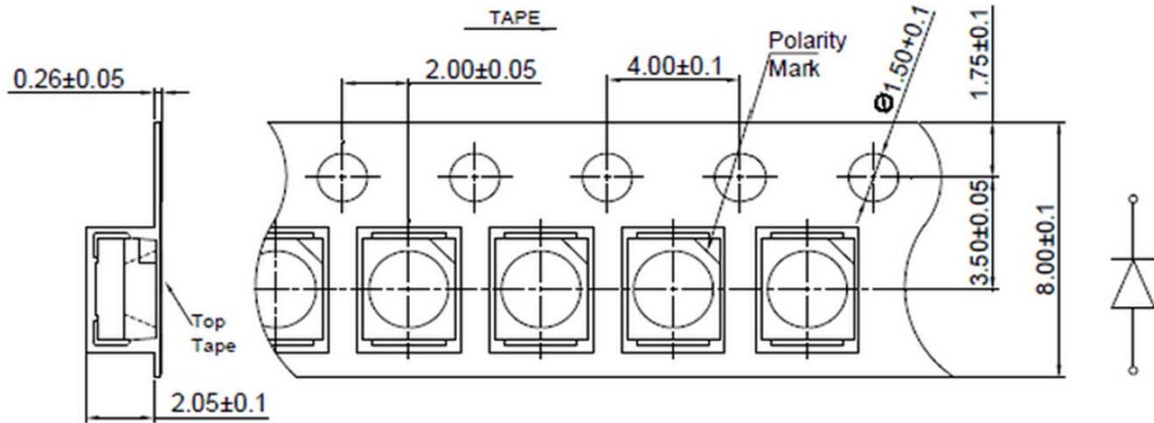

Note: The tolerances unless mentioned is ± 0.1 mm, Unit=mm

Notes:

- (1) Quantity : 4,000pcs/Reel
- (2) Cumulative Tolerance : Cumulative Tolerance/10 pitches to be ± 0.2 mm
- (3) Adhesion Strength of Cover Tape : Adhesion strength to be 0.1-0.7N when the cover tape is turned off from the carrier tape at the angle of 10° to the carrier tape
- (4) Package : P/N, Manufacturing data Code No. and quantity to be indicated on a damp proof Package.

PACKAGING

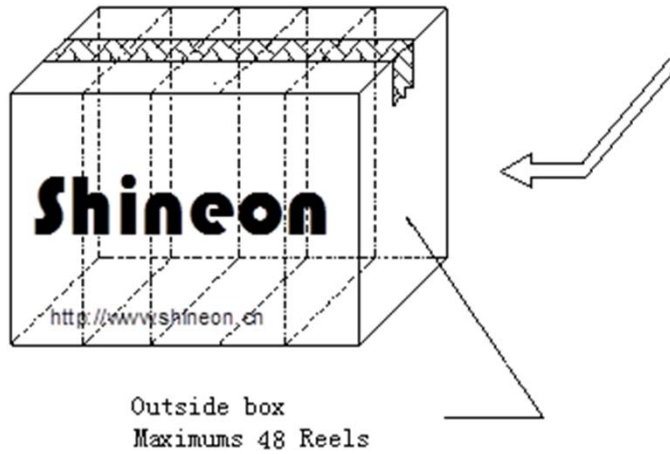
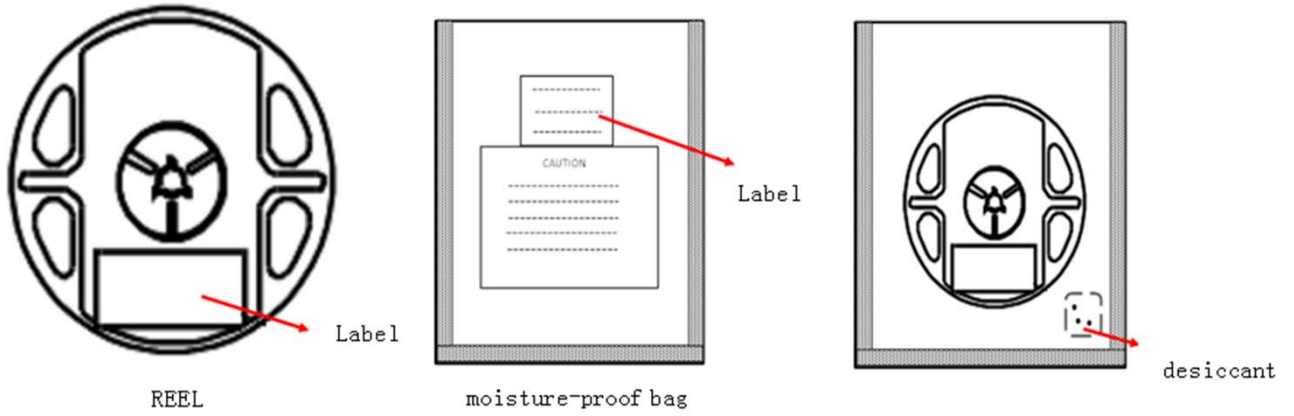

Reliability Test Items

| Test Items | Test Duration | Number of Damaged |
|---|---------------|-------------------|
| Steady State Operating Life of High Temperature (HTOL) $T_s=85^{\circ}\text{C}$, IF=Max | 1000hrs | 0/20 |
| Steady State Operating Life of Low Temperature (LTOL) $T_a=-40^{\circ}\text{C}$, IF=Max | 1000hrs | 0/20 |
| Pulse Wet Operating Life of High Temperature (PWHTOL) $60^{\circ}\text{C}/90\%\text{RH}$, IF30mins ON/30min OFF | 500hrs | 0/20 |
| High Temperature Storage (HTS) 100°C | 1000hrs | 0/20 |
| Low Temperature Storage (LTS) -40°C | 1000hrs | 0/20 |
| Thermal Shock (TS) $-45^{\circ}\text{C}\sim 125^{\circ}\text{C}$ 30min dwell 20sec transfer | 200cycles | 0/20 |
| Solder Resistance (SR) 265°C , 3X MSL | 5sec | 0/20 |
| Solder Ability (SA) 245°C 5sec, 95% coverage | 5sec | 0/11 |
| Mechanical Shock (MS) 1500G 0.5msec pulse shock | Each6 axis | 0/6 |
| Random Vibration (RV) 6G RMS, 10-2000Hz, 10min | Per axis | 0/6 |
| Variable Vibration Frequency (VVF) 10-2000-10Hz, log or linear sweep rate, 20G for 1 min, 1.5mm each apply 3x per axis over | 6hrs | 0/6 |
| Salt Spread (SS) 35°C , 30g/m ² /day | 48hrs | 0/11 |

| Item | Symbol | Test Condition | Criteria for Judgment | |
|---------------|--------|--------------------|-----------------------|------------|
| | | | Min. | Max. |
| Forward | Vf | IF=Typical Current | | U.S.L x1.1 |
| Luminous Flux | Im | IF=Typical Current | L.S.L x0.7 | |
| CCX&CCY | x,y | IF=Typical Current | | Shift<0.02 |

PRECAUTION FOR USE

- (1) This device should not be used in any type of fluid such as water, oil, organic solvent, etc. When washing is required, IPA should be used.
- (2) When the LEDs are illuminating, operating current should be decided after considering the ambient maximum temperature.
- (3) LEDs must be stored to maintain a clean atmosphere. If the LEDs are stored for 3 months or more after being shipped from ShineOn, a sealed container with a nitrogen atmosphere should be used for storage.
- (4) The LEDs must be used within seven days after opening the moisture proof packing. Repack unused Products with anti-moisture packing, fold to close any opening and then store in a dry place.
- (5) The appearance and specifications of the product may be modified for improvement without notice.
- (6) This LED is sensitive to the static electricity and surge. It is recommended to use a wrist Band or anti-electrostatic glove when handling the LEDs.
- (7) On manual soldering, a solder tip must be needed as grounded for usage. If over voltage which exceeds the absolute maximum rating is applied to LEDs, it will cause damage LEDs and result in destruction. Damaged LEDs will show some unusual characteristics such as leak current remarkably increase ,turn-on voltage becomes lower and the LEDs get unlighted at low current.