

Miniature Waterproof Shielded Connectors

LF Series



Mated dimensions (Example : LF07)

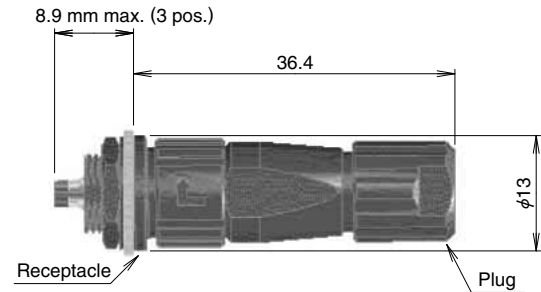

Fig. 1

■ Features

1. Ease of shielded termination and connector assembly

All components are self-aligning and do not require complex assembly tooling. The shield of the cable is connected with the metal housing of the connector using simple shielding clamp, supplied with the connector. (Fig. 2)

2. Water and dust protected

The LF series is a rugged, waterproof connector series that is IP67 and IP68 rated in the mated condition.

IP67 : Left in water at a depth of 1 m for 30 minutes

IP68 : Left in water at a depth of 2 m for 14 days

3. Simplified assembly procedure

No use of screws makes wiring and mounting easier.

4. Bayonet lock

Short turn bayonet lock assures secure vibration resistant mating of the connectors. (Fig. 3)

5. Acquired safety standard

4 pos. is 10A and meets safety standards (TÜV)

Also 3- and 4-pos. have acquired the UL standard.

6. High current rating capacity

| No. of contacts | Current rating |
|-----------------|---------------------|
| 3 | 5A max. |
| 4 | 10A max. |
| 6, 12 and 20 | 2A max. |
| 11 | 10A max. 2A max. |

Shielding Connection - Plug

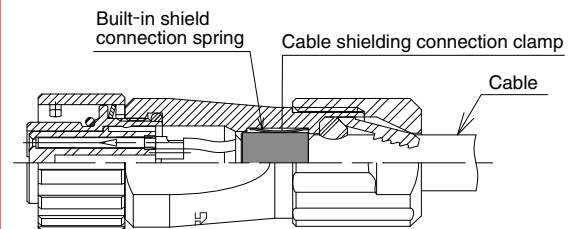
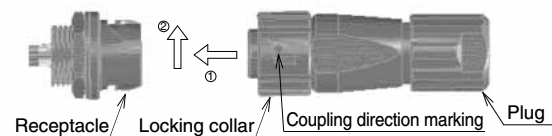

Fig. 2

Short turn bayonet lock

Mating:

Insert the plug, and then turn the locking collar clockwise, as indicated by the coupling direction marking.



Un-mating:

Turn the locking collar counter-clockwise then pull off the plug.

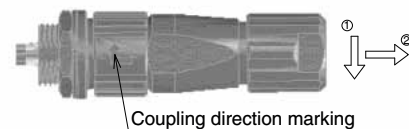

Fig. 3

■ Product Specifications

| | | |
|---------|-----------------------------|---|
| Ratings | Voltage rating | 125V AC, 175V DC (3 pos.) 125V AC, 125V DC (4 pos.) 30V AC, 42V DC (6 pos., 12pos., 20pos.) 125V AC, 125V DC (11 pos. A to D) 30V AC, 42V DC (11 pos. 1 to 7) |
| | Current rating | 5A max. (3 pos.) 10A max. (4 pos.) 2A max. (6 pos., 12pos., 20pos.) 10A(11 pos. A to D), 2A(11 pos. 1 to 7) |
| | Operating temperature range | -25°C to +85°C |
| | Storage temperature range | -10°C to +60°C |

| Item | Specifications | Conditions |
|---------------------------------|---|---|
| 1.Contact resistance | 15mΩ max. (3, 6, 12, 20 pos.) 5mΩ max. (4 pos.) 5mΩ max. (A to D), 15mΩ max. (1 to 7)(11 pos.) | 1A DC |
| 2.Insulation resistance | 1000MΩ min. | 500V DC (3, 4 pos.) 100V DC (6, 12, 20 pos.) 500V DC (A to D), 100V DC (1 to 7)(11pos.) |
| 3.Withstanding voltage | No flashover or insulation breakdown. | 1250V AC/1 minute (3, 4 pos.) 300V AC/1 minute (6, 12, 20 pos.) 1250V AC(A to D),300V AC(1 to 7) / 1 minute(11pos.) |
| 4.Vibration | No electrical discontinuity for 10μs max. | 10 → 55 → 10Hz /cycle, single amplitude of 0.75mm 5 minutes / cycle, three directions, 10 cycles for each direction. |
| 5.Shock | No electrical discontinuity for 10μs max | Acceleration of 490m/s ² , duration of 11ms, three directions, three times for each direction. |
| 6.Durability (Mating/un-mating) | 30mΩ max. (3, 6, 12, 20 pos.) 10mΩ max. (4 pos.) 10mΩ max.(A to D), 30mΩ max.(1 to 7)(11pos.) | 1000 cycles |
| 7.Temperature cycle | Insulation resistance : 100MΩ min. | Temperature : -55°C → Room temperature → +85°C → Room temperature Time : 30 → 2 to 3 → 30 → 2 to 3 (minutes) 5 cycles |
| 8.Humidity | Insulation resistance : 10MΩ min. (at high humidity condition) Insulation resistance : 100MΩ min. (at dry condition) | 96 hours at temperature of 40°C and humidity of 90% to 95%. |
| 9.Water / dust protection | When mated with corresponding connector. | Complete dust protection. No water penetration when submerged for 48 hours at the depth of 1.8 meter. |

■ Materials / Finish

| Components | Material | Finish / Color | Remarks |
|-------------------|--------------------|-----------------------|---------|
| Body / back shell | Zinc alloy | Nickel plated | ———— |
| Insulator | PPS | Black | UL94V-0 |
| Contacts | Copper alloy | Selective Gold plated | ———— |
| Packing | Chloroprene rubber | Black | ———— |
| Tightening collar | PPS | Brown | UL94V-0 |

■ Product Number Structure

Refer to the chart below when determining the product specifications from the product number.

Please select from the product numbers listed in this catalog when placing orders.

LF 07 - W B P * - 6 S ()**

① ② ③ ④ ⑤ ⑥ ⑦ ⑧

| | | | |
|------------------|--|--------------------------|--|
| ① Series name | : LF | ⑥ No. of contacts | : 3, 4, 6, 11, 12, 20 |
| ② Shell size | 07 10 13 | ⑦ Contact type | P : Male contact S : Female contact |
| ③ Waterproof | W : Waterproof type | ⑧ Other specifications : | A two-digit character is added to indicate other specifications as needed. |
| ④ Lock Mechanism | B : Bayonet lock | | |
| ⑤ Connector type | P : Plug R : Receptacle J : Jack (* : Form change zoning symbols in an identical class) | | |

■ Plugs

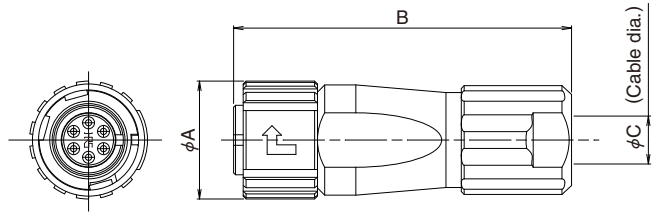

(Representative example.)

Unit : mm

| Part No. | HRS No. | No. of contacts | ϕA | B | ϕC | Weight |
|-----------------|---------------|-----------------|----------|------|----------|--------|
| LF07WBP-3S(31) | 136-0003-7 31 | 3 | 12.3 | 35.8 | 5 | 11g |
| LF07WBP-3P(31) | 136-0004-0 31 | | | | | |
| LF07WBP-6S(31) | 136-0001-1 31 | 6 | 12.3 | 35.8 | 5 | 11g |
| LF07WBP-6P(31) | 136-0002-4 31 | | | | | |
| LF10WBP-4S(31) | 136-0005-2 31 | 4 | 14.8 | 41.8 | 7.3 | 17g |
| LF10WBP-4P(31) | 136-0006-5 31 | | | | | |
| LF10WBP-12S(31) | 136-0007-8 31 | 12 | 14.8 | 41.8 | 7.3 | 16g |
| LF10WBP-12P(31) | 136-0008-0 31 | | | | | |
| LF13WBP-20S | 136-0009-3 | 20 | 17.9 | 51.9 | 8.7 | 29g |
| LF13WBP-20P | 136-0010-2 | | | | | |
| LF13WBP-11S | 136-0011-5 | 11 | 17.9 | 51.9 | 8.7 | 29g |
| LF13WBP-11P | 136-0012-8 | | | | | |

● Lock ease type

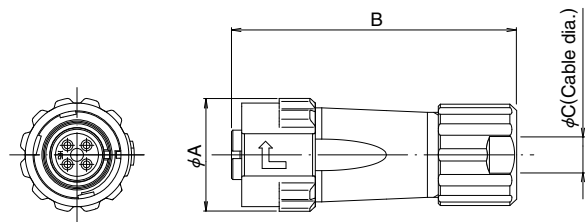

(Representative example.)

Unit : mm

| Part No. | HRS No. | No. of contacts | ϕA | B | ϕC | Weight |
|------------------|---------------|-----------------|----------|------|----------|--------|
| LF07WBPD-6S(31) | 136-0020-6 31 | 6 | 14.3 | 35.8 | 5 | 12g |
| LF10WBPD-4S(31) | 136-0014-3 31 | 4 | 16.8 | 41.8 | 7.3 | 19g |
| LF10WBPD-4P(31) | 136-0017-1 31 | | | | | |
| LF10WBPD-12S(31) | 136-0015-6 31 | 12 | 16.8 | 41.8 | 7.3 | 19g |
| LF10WBPD-12P(31) | 136-0018-4 31 | | | | | |

■ Receptacles

● Front panel mount type · Solder Type

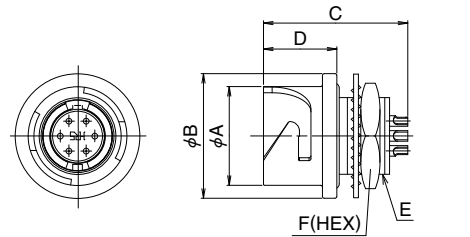

(Representative example.)

Unit : mm

| Part No. | HRS No. | No. of contacts | ϕA | ϕB | C | D | E | F | Weight | |
|-------------|------------|-----------------|----------|----------|-------|------|----------|----|--------|----|
| LF07WBR-3P | 136-1003-2 | 3 | 10.3 | 13 | 16.55 | 7.65 | M9×0.75 | 11 | 4g | |
| LF07WBR-3S | 136-1004-5 | | | | 15.05 | | | | | |
| LF07WBR-6P | 136-1001-7 | 6 | | | 15.25 | | | | | |
| LF07WBR-6S | 136-1002-0 | | | | | | | | | |
| LF10WBR-4P | 136-1005-8 | 4 | 12.8 | 15.3 | 19.05 | 7.75 | M11×0.75 | 13 | 6g | |
| LF10WBR-4S | 136-1006-0 | | | | | | | | | |
| LF10WBR-12P | 136-1007-3 | 12 | | | 17.25 | | | | | 5g |
| LF10WBR-12S | 136-1008-6 | | | | | | | | 6g | |
| LF13WBR-20P | 136-1009-9 | 20 | 15.9 | 18.3 | 17.25 | 7.75 | M14×0.75 | 17 | 9g | |
| LF13WBR-20S | 136-1010-8 | | | | 19.05 | | | | 10g | |
| LF13WBR-11P | 136-1011-0 | 11 | | | 19.05 | | | | | 9g |
| LF13WBR-11S | 136-1012-3 | | | | | | | | 10g | |

● Front panel mount type · Through hole Type

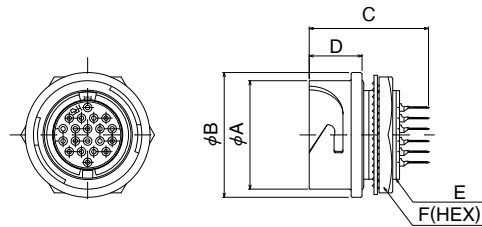

(Representative example.)

Unit : mm

| Part No. | HRS No. | No. of contacts | ϕA | ϕB | C | D | E | F | Weight |
|--------------|------------|-----------------|----------|----------|------|------|----------|----|--------|
| LF13WBR-20SD | 136-1017-7 | 20 | 15.9 | 18.3 | 17.5 | 7.75 | M14×0.75 | 17 | 9g |

■ Receptacles

● Rear panel mount type · Solder Type

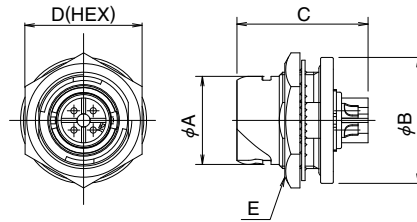

(Representative example.)

Unit : mm

| Part No. | HRS No. | No. of contacts | ϕA | ϕB | C | D | E | Weight |
|--------------|------------|-----------------|----------|----------|-------|----|----------|--------|
| LF10WBRB-4P | 136-1118-4 | 4 | 12.8 | 18.3 | 19.05 | 17 | M14×0.75 | 10g |
| LF10WBRB-12P | 136-1013-6 | 12 | | | 17.25 | | | |
| LF10WBRB-12S | 136-1014-9 | 12 | 15.9 | 21.5 | 19.25 | 20 | M17×0.75 | 16g |
| LF13WBRB-20S | 136-1018-0 | 20 | | | | | | |
| LF13WBRB-11S | 136-1019-2 | 11 | | | | | | |

● Rear panel mount type · Through hole Type

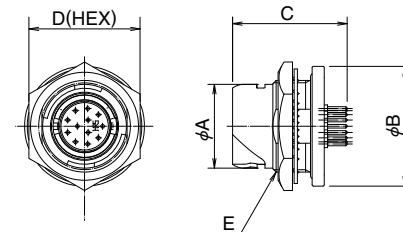

(Representative example.)

Unit : mm

| Part No. | HRS No. | No. of contacts | ϕA | ϕB | C | D | E | Weight |
|---------------|------------|-----------------|----------|----------|------|----|----------|--------|
| LF10WBRB-12PD | 136-1015-1 | 12 | 12.8 | 18.3 | 17.5 | 17 | M14×0.75 | 9g |
| LF10WBRB-12SD | 136-1016-4 | | | | | | | |

■ Jacks

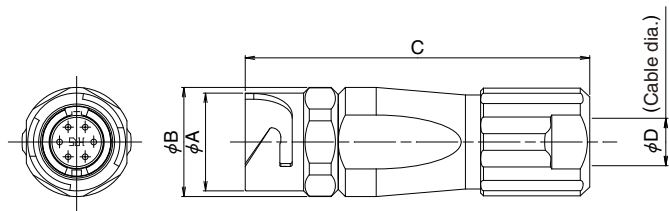

(Representative example.)

Unit : mm

| Part No. | HRS No. | No. of contacts | ϕA | ϕB | C | ϕD | Weight |
|-------------|------------|-----------------|----------|----------|------|----------|--------|
| LF07WBJ-3P | 136-2003-8 | 3 | 10.3 | 11.5 | 36.3 | 5 | 11g |
| LF07WBJ-3S | 136-2004-0 | | | | | | |
| LF07WBJ-6P | 136-2001-2 | 6 | 12.8 | 13.8 | 42.4 | 7.3 | 16g |
| LF07WBJ-6S | 136-2002-5 | | | | | | |
| LF10WBJ-4P | 136-2005-3 | 4 | 12.8 | 13.8 | 42.4 | 7.3 | 16g |
| LF10WBJ-4S | 136-2006-6 | | | | | | |
| LF10WBJ-12P | 136-2007-9 | 12 | 15.9 | 16.9 | 52.4 | 8.7 | 29g |
| LF10WBJ-12S | 136-2008-1 | | | | | | 30g |
| LF13WBJ-20P | 136-2009-4 | 20 | 15.9 | 16.9 | 52.4 | 8.7 | 29g |
| LF13WBJ-20S | 136-2010-3 | | | | | | 30g |
| LF13WBJ-11P | 136-2011-6 | 11 | 15.9 | 16.9 | 52.4 | 8.7 | 29g |
| LF13WBJ-11S | 136-2012-9 | | | | | | 30g |

■ CAP

● For Receptacles

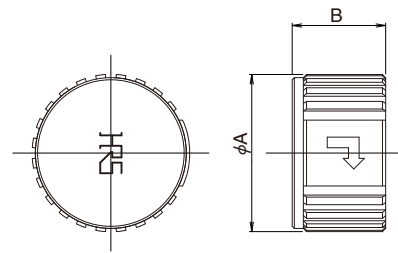

(Representative example.)

Unit : mm

| Part No. | HRS No. | Applicable connector | φA | B | Weight | |
|---------------|------------|----------------------|------|-----|--------|----|
| LF07WBR-C | 136-3008-7 | LF07WBR-6P | 12.3 | 8.8 | 4g | |
| | | LF07WBR-6S | | | | |
| | | LF07WBR-3P | | | | |
| | | LF07WBR-3S | | | | |
| LF10WBR-C | 136-3001-8 | LF10WBR-4P | 14.8 | | 8.8 | 5g |
| | | LF10WBR-4S | | | | |
| | | LF10WBR-12P | | | | |
| | | LF10WBR-12S | | | | |
| | | LF10WBRB-4P | | | | |
| | | LF10WBRB-12P | | | | |
| | | LF10WBRB-12S | | | | |
| | | LF10WBRB-12PD | | | | |
| LF10WBRB-12SD | | | | | | |
| LF13WBR-C | 136-3003-3 | LF13WBR-20P | 17.9 | 8.8 | 7g | |
| | | LF13WBR-20S | | | | |
| | | LF13WBR-11P | | | | |
| | | LF13WBR-11S | | | | |
| | | LF13WBR-20SD | | | | |
| | | LF13WBRB-20S | | | | |
| | | LF13WBRB-11S | | | | |

◆Applicable tools

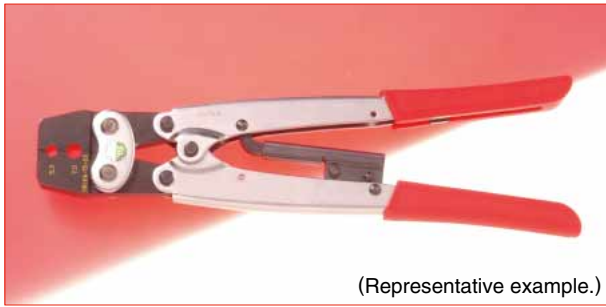

Unit : mm

| Description | Part No. | HRS No. | LF series Applicable cable dia. |
|--------------------------|-------------|------------|---------------------------------|
| Manual cable clamp crimp | HR10A-TC-02 | 150-0041-2 | 5 (Note) |
| | LF-TC-01 | 150-0234-6 | 7.3 · 8.7 |

Note : Applicable cable dia. is only 5mm for LF series.

◆Solder termination fixture



| Part No. | HRS No. | Applicable connectors |
|------------|------------|-----------------------|
| LF07BP-T01 | 150-0232-0 | LF07WBP-** |
| LF07BJ-T01 | 150-0233-3 | LF07WBJ-** |
| LF10BP-T01 | 150-0235-9 | LF10WBP-** |
| LF10BJ-T01 | 150-0236-1 | LF10WBJ-** |
| LF13BP-T01 | 150-0237-4 | LF13WBP-** |
| LF13BJ-T01 | 150-0238-7 | LF13WBJ-** |

Note : It is applicable regard less of given alphabets or Numbers shown at *.

◆Panel Cutout

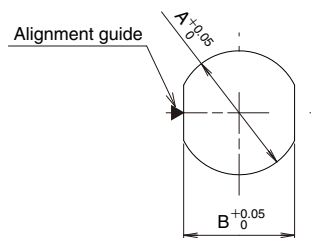

Unit : mm

| Shell size | A | B | Weight |
|-------------|--------------|------|------------|
| LF07WBR-** | $\phi 9.05$ | 8.1 | 0.7 to 2 |
| LF10WBR-** | $\phi 11.05$ | 10.2 | |
| LF13WBR-** | $\phi 14.05$ | 13.1 | |
| LF10WBRB-** | $\phi 14.05$ | 13.1 | 0.7 to 4.8 |
| LF13WBRB-** | $\phi 17.05$ | 16.1 | |

◆Contact position arrangement and specifications

| Shell size | LF07 | | LF10 | | LF13 | | |
|---------------------------|----------------|---------|-------------|--------------|-------------|--------------|--------------|
| Contact arrangement | | | | | | | |
| No. of contacts | 3 | 6 | 4 | 12 | 11 | 20 | |
| Withstanding voltage | 1250V AC | 300V AC | 1250V AC | 300V AC | 4 | 7 | AC300V |
| | | | | | AC1250V | AC300V | |
| Current rating | 5A | 2A | 10A | 2A | 4 | 7 | 2A |
| | | | | | 10A | 2A | |
| Insulation resistance | 1000M Ω | | | | | | |
| Contact resistance | 15m Ω | | 5m Ω | 15m Ω | 4 | 7 | 15m Ω |
| | | | | | 5m Ω | 15m Ω | |
| Solder pot inner diameter | 1.15mm | 0.8mm | 1.7mm | 0.8mm | 4 | 7 | 0.8mm |
| | | | | | $\phi 1.7$ | $\phi 0.8$ | |

Note 1 : The contact configuration as viewed from the female contact connector mating side.

Note 2 : The ▼ symbol indicates polarizing key position.

Note 3 : Withstanding voltages are test voltage values.

◆ Termination and Assembly Instructions

The connectors are delivered with pre-assembled condition and the disassembly as shown No.1.

| No. | Illustration | Operation | | | | | | | | |
|------------------|--|--|----------------------|----------------------|---------------------|---------------------|-----------------------|-----------------------|-------------------------|-------------------------|
| 1 | | <p>Plug disassembly</p> <p>① Insert the plug into securely held solder termination fixture as shown.</p> <table border="1"> <thead> <tr> <th>Fixture Part No.</th> <th>Applicable connector</th> </tr> </thead> <tbody> <tr> <td>LF07BP-T01</td> <td>LF07WBP-6S,6P,3S,3P</td> </tr> <tr> <td>LF10BP-T01</td> <td>LF10WBP-4S,4P,12S,12P</td> </tr> <tr> <td>LF13BP-T01</td> <td>LF13WBP-20S,20P,11S,11P</td> </tr> </tbody> </table> | Fixture Part No. | Applicable connector | LF07BP-T01 | LF07WBP-6S,6P,3S,3P | LF10BP-T01 | LF10WBP-4S,4P,12S,12P | LF13BP-T01 | LF13WBP-20S,20P,11S,11P |
| | Fixture Part No. | Applicable connector | | | | | | | | |
| | LF07BP-T01 | LF07WBP-6S,6P,3S,3P | | | | | | | | |
| | LF10BP-T01 | LF10WBP-4S,4P,12S,12P | | | | | | | | |
| LF13BP-T01 | LF13WBP-20S,20P,11S,11P | | | | | | | | | |
| | <p>② Loosen the backshell turning it counter clockwise and remove it from the body/ insulator assembly.</p> <p>Note When removing, assembling and wiring, be sure to use a solder termination fixture. Directly fixing the locking collar in place with a vice etc.. could lead to damage, deformation or lacuna of retaining ring.</p> | | | | | | | | | |
| | <p>Jack Disassembly</p> <p>① Insert the jack into the securely held solder termination fixture as shown.</p> <table border="1"> <thead> <tr> <th>Fixture Part No.</th> <th>Applicable connector</th> </tr> </thead> <tbody> <tr> <td>LF07BJ-T01</td> <td>LF07WBJ-6S,6P,3S,3P</td> </tr> <tr> <td>LF10BJ-T01</td> <td>LF10WBJ-4S,4P,12S,12P</td> </tr> <tr> <td>LF13BJ-T01</td> <td>LF13WBJ-20S,20P,11S,11P</td> </tr> </tbody> </table> | Fixture Part No. | Applicable connector | LF07BJ-T01 | LF07WBJ-6S,6P,3S,3P | LF10BJ-T01 | LF10WBJ-4S,4P,12S,12P | LF13BJ-T01 | LF13WBJ-20S,20P,11S,11P | |
| Fixture Part No. | Applicable connector | | | | | | | | | |
| LF07BJ-T01 | LF07WBJ-6S,6P,3S,3P | | | | | | | | | |
| LF10BJ-T01 | LF10WBJ-4S,4P,12S,12P | | | | | | | | | |
| LF13BJ-T01 | LF13WBJ-20S,20P,11S,11P | | | | | | | | | |
| | <p>② Loosen the backshell turning it counterclockwise.</p> <p>Note When removing, assembling and wiring, be sure to use a solder termination fixture. Directly fixing the body in place with a vice etc.. could lead to damage or deformation.</p> | | | | | | | | | |
| 2 | | <p>Connector Assembly</p> <p>① Apply a coating of Loctite 7649 (Manufactured by Henkel Japan, Ltd.) primer to the threaded sections of the backshell and the tightening collar. Completely dry the coated surfaces.</p> <p>Notes</p> <ol style="list-style-type: none"> (1) Drying time at room temperature is approximately 30 to 70 seconds. (2) Ensure sufficient ventilation of the area at time of drying. (3) Take necessary steps to protect the coated surfaces from contamination. | | | | | | | | |
| | | <p>② Thread the tightening collar, strain relief collar, seal bushing and the backshell over the cable as illustrated.</p> <p>Note Threading the components may not be possible after the cable-end finishing process.</p> | | | | | | | | |

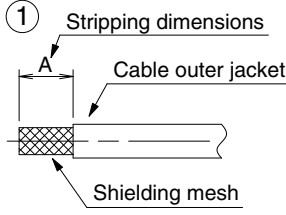
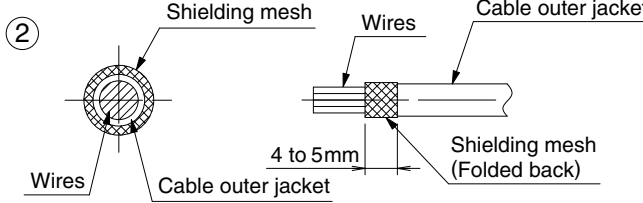
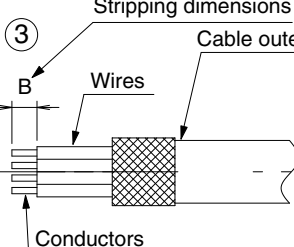
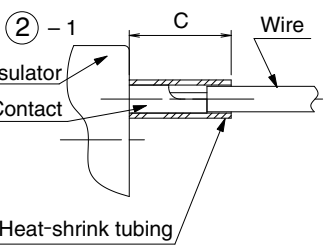
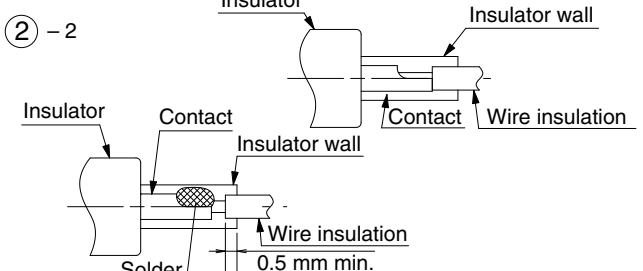
| No. | Illustration | Operation | | | | | | | | | | | | | | | | | | | | | | | | | | | |
|-------------------|---|-------------------|-----------------|------|--------|--------|---|----------|----|----------|----------|--|--------|----------|-------------------|--------|---|------------------|---|-------|---------|-------|--|-------|----|--|----|-------|---|
| 3 | <p>① Stripping dimensions</p>  <p>Table 1. Stripping Dimensions</p> <table border="1" data-bbox="582 414 933 593"> <thead> <tr> <th>No. of Conductors</th> <th>A mm</th> </tr> </thead> <tbody> <tr> <td>3</td> <td rowspan="2">8 to 9</td> </tr> <tr> <td>6</td> </tr> <tr> <td>4</td> <td>13 to 14</td> </tr> <tr> <td>12</td> <td>14 to 15</td> </tr> <tr> <td>11</td> <td>22 to 23 (No.A to D) 23 to 24 (No.1 to 7)</td> </tr> <tr> <td>20</td> <td>23 to 24</td> </tr> </tbody> </table> <p>②</p>  <p>③ Stripping dimensions</p>  <p>Table 2. Stripping Dimensions</p> <table border="1" data-bbox="614 918 933 1086"> <thead> <tr> <th>No. of Conductors</th> <th>B mm</th> </tr> </thead> <tbody> <tr> <td>3</td> <td>2.5±0.5</td> </tr> <tr> <td>6</td> <td>2±0.5</td> </tr> <tr> <td>4</td> <td>3±0.5</td> </tr> <tr> <td>12</td> <td>2±0.5</td> </tr> <tr> <td>11</td> <td>3±0.5 (No.A to D) 2±0.5 (No.1 to 7)</td> </tr> <tr> <td>20</td> <td>2±0.5</td> </tr> </tbody> </table> | No. of Conductors | A mm | 3 | 8 to 9 | 6 | 4 | 13 to 14 | 12 | 14 to 15 | 11 | 22 to 23 (No.A to D) 23 to 24 (No.1 to 7) | 20 | 23 to 24 | No. of Conductors | B mm | 3 | 2.5±0.5 | 6 | 2±0.5 | 4 | 3±0.5 | 12 | 2±0.5 | 11 | 3±0.5 (No.A to D) 2±0.5 (No.1 to 7) | 20 | 2±0.5 | <p>Cable preparation</p> <p>① Strip the cable's outer jacket to the dimensions illustrated in the table 1.</p> <p>Notes</p> <ul style="list-style-type: none"> (1) Exercise caution not to damage the shielding mesh. (2) Any damage to the cable's outer jacket may affect the waterproof performance of the assembled connector. <p>② Fold back the shielding mesh over the cable's outer jacket assuring that it is uniform on its diameter.</p> <p>③ Strip the wires to the dimensions illustrated in the Table 2.</p> <p>Note</p> <p>When stripping the wires exercise caution not to damage it's insulation, folded over shielding mesh or cable's outer jacket. It may cause defects in insulation, conduction, and waterproof performance.</p> |
| No. of Conductors | A mm | | | | | | | | | | | | | | | | | | | | | | | | | | | | |
| 3 | 8 to 9 | | | | | | | | | | | | | | | | | | | | | | | | | | | | |
| 6 | | | | | | | | | | | | | | | | | | | | | | | | | | | | | |
| 4 | 13 to 14 | | | | | | | | | | | | | | | | | | | | | | | | | | | | |
| 12 | 14 to 15 | | | | | | | | | | | | | | | | | | | | | | | | | | | | |
| 11 | 22 to 23 (No.A to D) 23 to 24 (No.1 to 7) | | | | | | | | | | | | | | | | | | | | | | | | | | | | |
| 20 | 23 to 24 | | | | | | | | | | | | | | | | | | | | | | | | | | | | |
| No. of Conductors | B mm | | | | | | | | | | | | | | | | | | | | | | | | | | | | |
| 3 | 2.5±0.5 | | | | | | | | | | | | | | | | | | | | | | | | | | | | |
| 6 | 2±0.5 | | | | | | | | | | | | | | | | | | | | | | | | | | | | |
| 4 | 3±0.5 | | | | | | | | | | | | | | | | | | | | | | | | | | | | |
| 12 | 2±0.5 | | | | | | | | | | | | | | | | | | | | | | | | | | | | |
| 11 | 3±0.5 (No.A to D) 2±0.5 (No.1 to 7) | | | | | | | | | | | | | | | | | | | | | | | | | | | | |
| 20 | 2±0.5 | | | | | | | | | | | | | | | | | | | | | | | | | | | | |
| 4 | <p>② - 1</p>  <p>Table 3 Heat shrink tubing Dimensions</p> <table border="1" data-bbox="622 1489 933 1758"> <thead> <tr> <th>No. of Conductors</th> <th>No. of contacts</th> <th>C mm</th> </tr> </thead> <tbody> <tr> <td rowspan="2">6</td> <td>1 to 6</td> <td>4</td> </tr> <tr> <td>1 to 9</td> <td>4</td> </tr> <tr> <td rowspan="2">12</td> <td>10 to 12</td> <td>6</td> </tr> <tr> <td>1 to 4</td> <td>6</td> </tr> <tr> <td rowspan="2">11</td> <td>5 to 7</td> <td>4</td> </tr> <tr> <td>1 to 5, 16 to 20</td> <td>4</td> </tr> <tr> <td rowspan="2">20</td> <td>6 to 15</td> <td>6</td> </tr> </tbody> </table> <p>② - 2</p>  | No. of Conductors | No. of contacts | C mm | 6 | 1 to 6 | 4 | 1 to 9 | 4 | 12 | 10 to 12 | 6 | 1 to 4 | 6 | 11 | 5 to 7 | 4 | 1 to 5, 16 to 20 | 4 | 20 | 6 to 15 | 6 | <p>Soldering</p> <p>① Soldering conditions</p> <ul style="list-style-type: none"> Soldering iron tip temperature: 350±10℃ Soldering time: within 5 sec. <p>Notes</p> <ul style="list-style-type: none"> (1) Assure that the solder compound is sufficiently melted on the soldering iron tip. (2) When applying, make sure that the solder will flow correctly at all the contact surfaces between the conductor and the contact. <p>② - 1 6, 12, 11(No.1 to 7), 20 Conductors</p> <ul style="list-style-type: none"> (1) Place a heat-shrink tubing (inside diameter of 1.1 mm min.) over every other wire. Perform the soldering of the contact and the (2) conductor, with the wire's insulation touching the contact as shown. After soldering, slide the heat shrink tubing (3) over the soldered joint and shrink it. The tubing should touch the insulator as shown. <p>② - 2 3, 4, 11(No.A to D) Conductors</p> <ul style="list-style-type: none"> (1) Perform the soldering of the contact and the conductor, with the wire's insulation touching the contact as illustrated. (2) When soldering, to maintain the insulation between adjacent contacts. Make sure that the wire's insulation remains below the edge of the insulator's wall 0.5 mm min., as illustrated. | | | | | | |
| No. of Conductors | No. of contacts | C mm | | | | | | | | | | | | | | | | | | | | | | | | | | | |
| 6 | 1 to 6 | 4 | | | | | | | | | | | | | | | | | | | | | | | | | | | |
| | 1 to 9 | 4 | | | | | | | | | | | | | | | | | | | | | | | | | | | |
| 12 | 10 to 12 | 6 | | | | | | | | | | | | | | | | | | | | | | | | | | | |
| | 1 to 4 | 6 | | | | | | | | | | | | | | | | | | | | | | | | | | | |
| 11 | 5 to 7 | 4 | | | | | | | | | | | | | | | | | | | | | | | | | | | |
| | 1 to 5, 16 to 20 | 4 | | | | | | | | | | | | | | | | | | | | | | | | | | | |
| 20 | 6 to 15 | 6 | | | | | | | | | | | | | | | | | | | | | | | | | | | |

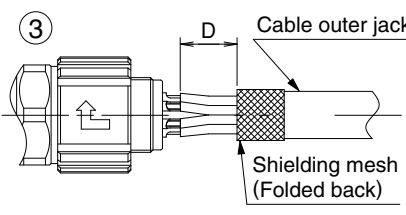
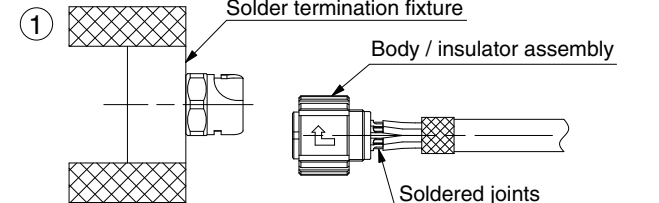
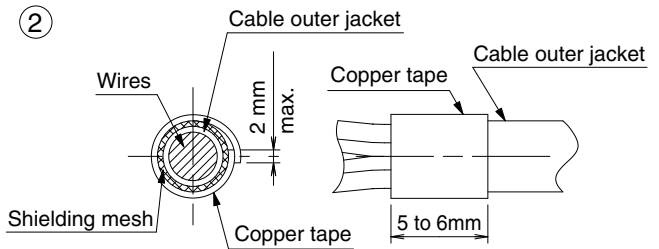
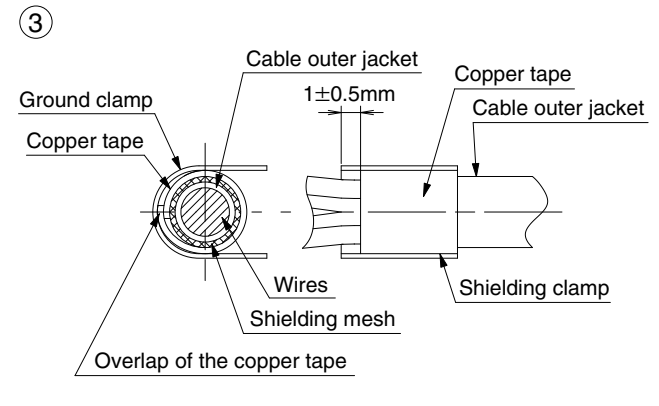
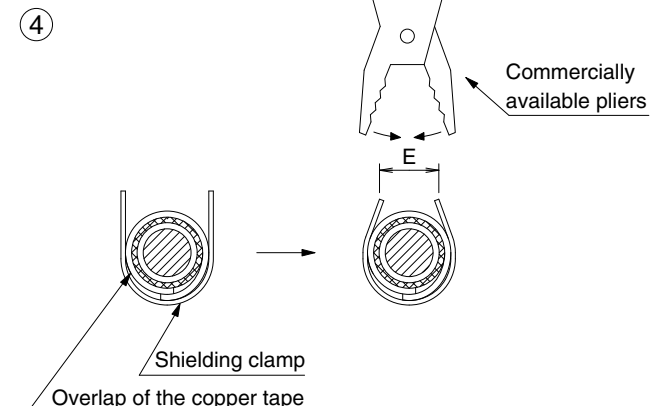
| No. | Illustration | Operation | | | | | | | | | | | | |
|-------------------|---|---|------------|---|--------|----------|------|----------|------|----------|----|----------|----|---|
| 4 |  <p>Table 4. Wire Dimensions</p> <table border="1" data-bbox="678 369 933 537"> <thead> <tr> <th>No. of Conductors</th> <th>D mm</th> </tr> </thead> <tbody> <tr> <td>3</td> <td rowspan="2">6 to 7</td> </tr> <tr> <td>6</td> </tr> <tr> <td>4</td> <td>10 to 11</td> </tr> <tr> <td>12</td> <td>13 to 14</td> </tr> <tr> <td>11</td> <td rowspan="2">18 to 19</td> </tr> <tr> <td>20</td> </tr> </tbody> </table> | No. of Conductors | D mm | 3 | 6 to 7 | 6 | 4 | 10 to 11 | 12 | 13 to 14 | 11 | 18 to 19 | 20 | <p>③ After the soldering, keep a distance of D between the contact end and the cable's outer jacket as illustrated.</p> <p>Note The distance of D is required in order to assure correct assembly of the backshell.</p> |
| No. of Conductors | D mm | | | | | | | | | | | | | |
| 3 | 6 to 7 | | | | | | | | | | | | | |
| 6 | | | | | | | | | | | | | | |
| 4 | 10 to 11 | | | | | | | | | | | | | |
| 12 | 13 to 14 | | | | | | | | | | | | | |
| 11 | 18 to 19 | | | | | | | | | | | | | |
| 20 | | | | | | | | | | | | | | |
| 5 |  | <p>Crimping of the Shielding Clamp</p> <p>① After completion of the soldering operations carefully remove (holding on the locking collar) the body/insulator assembly from the solder termination fixture.</p> <p>Note Exercise caution not to damage or deform the solder joints.</p> | | | | | | | | | | | | |
| |  | <p>② Wrap the folded over shielding mesh with 5 to 6mm wide copper tape to assure that it will not become loose. Apply the copper tape so that the shielding mesh does not protrude from under it.</p> <p>Note After wrapping the copper tape, the tape should overlap itself by 2mm max.</p> | | | | | | | | | | | | |
| |  | <p>③ Insert the "U" shaped shielding clamp over the copper tape as shown on the illustration. It is critical that the overlap of the copper tape is located inside the shielding clamp as shown on the illustration.</p> <p>Note When the end of the copper tape wrapping is positioned at the open side of the ground fitting, the end portion of the copper tape wrapping will no longer be covered by the ground fitting when the ground fitting is crimped.</p> | | | | | | | | | | | | |
| |  | <p>④ Using commercially available pliers bend the open ends of the shielding clamp as illustrated, assuring that it stays in place. The dimension of E, between opposing edges of the shielding clamp is necessary to assure correct final crimp.</p> <p>Table 5</p> <table border="1" data-bbox="989 1825 1300 1937"> <thead> <tr> <th>Shell size</th> <th>E</th> </tr> </thead> <tbody> <tr> <td>LF07</td> <td>5mm max.</td> </tr> <tr> <td>LF10</td> <td rowspan="2">7mm max.</td> </tr> <tr> <td>LF13</td> </tr> </tbody> </table> | Shell size | E | LF07 | 5mm max. | LF10 | 7mm max. | LF13 | | | | | |
| Shell size | E | | | | | | | | | | | | | |
| LF07 | 5mm max. | | | | | | | | | | | | | |
| LF10 | 7mm max. | | | | | | | | | | | | | |
| LF13 | | | | | | | | | | | | | | |

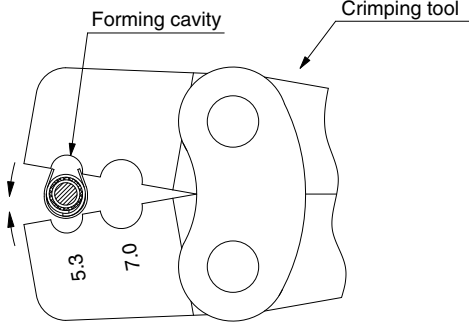
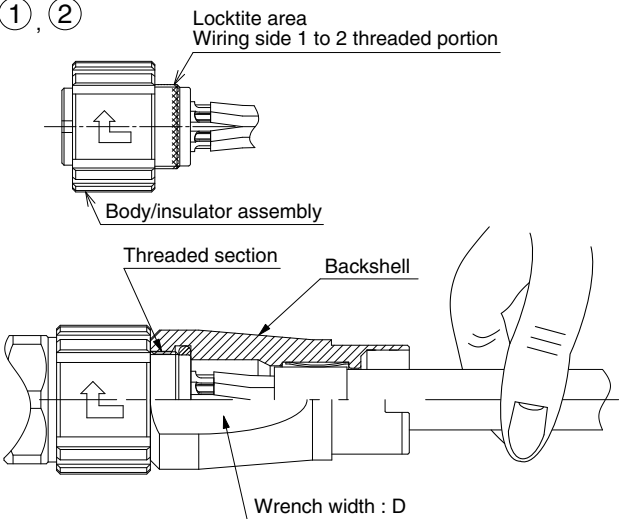
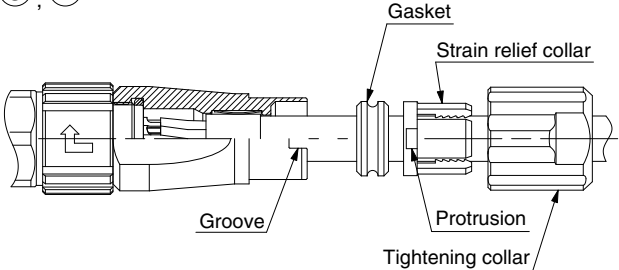
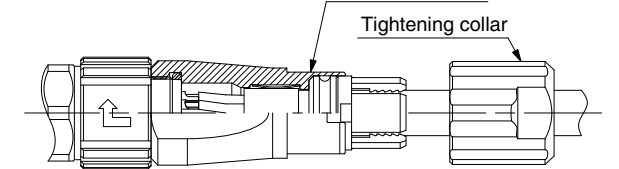
| No. | Illustration | Operation | | | | | | | | | | | | | | | | | | | | | | | | | | | | |
|------------------|---|--|---|----------------|---------------------------|---|-------------|------|----------------|----------------|------|----------------|------|---|------------------|----------------------|----------------|---------------------|------------|-----------------------|------------|-------------------------|------------------|----------------------|------------|---------------------|------------|-----------------------|------------|-------------------------|
| 5 | <p>⑤</p>  <p>Forming cavity</p> <p>Crimping tool</p> <p>5.3</p> <p>7.0</p> | <p>⑤ Both sides of the shielding clamp must be placed in the forming cavity of the tool (as shown on the illustration) and crimped over the cable by closing the tool completely.</p> <table border="1" data-bbox="954 432 1412 622"> <thead> <tr> <th>Crimping tool</th> <th>Forming cavity</th> <th>Applicable cable diameter</th> <th>Shielding clamp diameter after crimping</th> </tr> </thead> <tbody> <tr> <td rowspan="2">HR10A-TC-02</td> <td>5.3</td> <td>5mm</td> <td>5.3mm to 5.5mm</td> </tr> <tr> <td>7.0</td> <td>—</td> <td>—</td> </tr> <tr> <td rowspan="2">LF-TC-01</td> <td>7.9</td> <td>7.3mm</td> <td>7.9mm to 8.1mm</td> </tr> <tr> <td>9.1</td> <td>8.7mm</td> <td>9.1mm to 9.3mm</td> </tr> </tbody> </table> | Crimping tool | Forming cavity | Applicable cable diameter | Shielding clamp diameter after crimping | HR10A-TC-02 | 5.3 | 5mm | 5.3mm to 5.5mm | 7.0 | — | — | LF-TC-01 | 7.9 | 7.3mm | 7.9mm to 8.1mm | 9.1 | 8.7mm | 9.1mm to 9.3mm | | | | | | | | | | |
| Crimping tool | Forming cavity | Applicable cable diameter | Shielding clamp diameter after crimping | | | | | | | | | | | | | | | | | | | | | | | | | | | |
| HR10A-TC-02 | 5.3 | 5mm | 5.3mm to 5.5mm | | | | | | | | | | | | | | | | | | | | | | | | | | | |
| | 7.0 | — | — | | | | | | | | | | | | | | | | | | | | | | | | | | | |
| LF-TC-01 | 7.9 | 7.3mm | 7.9mm to 8.1mm | | | | | | | | | | | | | | | | | | | | | | | | | | | |
| | 9.1 | 8.7mm | 9.1mm to 9.3mm | | | | | | | | | | | | | | | | | | | | | | | | | | | |
| 6 | <p>①, ②</p>  <p>Locktite area Wiring side 1 to 2 threaded portion</p> <p>Body/insulator assembly</p> <p>Threaded section</p> <p>Backshell</p> <p>Wrench width : D</p> <p>Table 6 (Recommend tightening torque)</p> <table border="1" data-bbox="528 1249 911 1368"> <thead> <tr> <th>Shell size</th> <th>Tightening torque</th> <th>Wrench width</th> </tr> </thead> <tbody> <tr> <td>LF07</td> <td>1N·m to 1.5N·m</td> <td>10mm</td> </tr> <tr> <td>LF10</td> <td>1N·m to 1.5N·m</td> <td>13mm</td> </tr> <tr> <td>LF13</td> <td>1.5N·m to 2N·m</td> <td>16mm</td> </tr> </tbody> </table> | Shell size | Tightening torque | Wrench width | LF07 | 1N·m to 1.5N·m | 10mm | LF10 | 1N·m to 1.5N·m | 13mm | LF13 | 1.5N·m to 2N·m | 16mm | <h3>Connector Assembly</h3> <p>① Place the body/insulator assembly in the applicable solder termination fixture.</p> <p>For plug assembly</p> <table border="1" data-bbox="986 790 1337 869"> <thead> <tr> <th>Fixture Part No.</th> <th>Applicable connector</th> </tr> </thead> <tbody> <tr> <td>LF07BP-T01</td> <td>LF07WBP-6S,6P,3S,3P</td> </tr> <tr> <td>LF10BP-T01</td> <td>LF10WBP-4S,4P,12S,12P</td> </tr> <tr> <td>LF13BP-T01</td> <td>LF13WBP-20S,20P,11S,11P</td> </tr> </tbody> </table> <p>For jack assembly</p> <table border="1" data-bbox="986 891 1337 969"> <thead> <tr> <th>Fixture Part No.</th> <th>Applicable connector</th> </tr> </thead> <tbody> <tr> <td>LF07BJ-T01</td> <td>LF07WBJ-6S,6P,3S,3P</td> </tr> <tr> <td>LF10BJ-T01</td> <td>LF10WBJ-4S,4P,12S,12P</td> </tr> <tr> <td>LF13BJ-T01</td> <td>LF13WBJ-20S,20P,11S,11P</td> </tr> </tbody> </table> <p>② Coat the thread section of the body/insulator assembly with Loctite 263 compound (manufactured by Henkel Japan, Ltd.) or equivalent, tightening it with a torque specified in the table 6.</p> <p>Notes</p> <p>(1) The applied loctite should not protrude out further than the wiring side 1 to 2 threaded section. If it does, it may affect waterproof performance and locking. Please remove any protruding loctite with a cloth or cotton swab. etc.</p> <p>(2) It is critical that the cable itself will not turn or twist during this operation. It may cause breakage at the soldered area.</p> | Fixture Part No. | Applicable connector | LF07BP-T01 | LF07WBP-6S,6P,3S,3P | LF10BP-T01 | LF10WBP-4S,4P,12S,12P | LF13BP-T01 | LF13WBP-20S,20P,11S,11P | Fixture Part No. | Applicable connector | LF07BJ-T01 | LF07WBJ-6S,6P,3S,3P | LF10BJ-T01 | LF10WBJ-4S,4P,12S,12P | LF13BJ-T01 | LF13WBJ-20S,20P,11S,11P |
| Shell size | Tightening torque | Wrench width | | | | | | | | | | | | | | | | | | | | | | | | | | | | |
| LF07 | 1N·m to 1.5N·m | 10mm | | | | | | | | | | | | | | | | | | | | | | | | | | | | |
| LF10 | 1N·m to 1.5N·m | 13mm | | | | | | | | | | | | | | | | | | | | | | | | | | | | |
| LF13 | 1.5N·m to 2N·m | 16mm | | | | | | | | | | | | | | | | | | | | | | | | | | | | |
| Fixture Part No. | Applicable connector | | | | | | | | | | | | | | | | | | | | | | | | | | | | | |
| LF07BP-T01 | LF07WBP-6S,6P,3S,3P | | | | | | | | | | | | | | | | | | | | | | | | | | | | | |
| LF10BP-T01 | LF10WBP-4S,4P,12S,12P | | | | | | | | | | | | | | | | | | | | | | | | | | | | | |
| LF13BP-T01 | LF13WBP-20S,20P,11S,11P | | | | | | | | | | | | | | | | | | | | | | | | | | | | | |
| Fixture Part No. | Applicable connector | | | | | | | | | | | | | | | | | | | | | | | | | | | | | |
| LF07BJ-T01 | LF07WBJ-6S,6P,3S,3P | | | | | | | | | | | | | | | | | | | | | | | | | | | | | |
| LF10BJ-T01 | LF10WBJ-4S,4P,12S,12P | | | | | | | | | | | | | | | | | | | | | | | | | | | | | |
| LF13BJ-T01 | LF13WBJ-20S,20P,11S,11P | | | | | | | | | | | | | | | | | | | | | | | | | | | | | |
| | <p>③, ④</p>  <p>Gasket</p> <p>Strain relief collar</p> <p>Groove</p> <p>Protrusion</p> <p>Tightening collar</p> | <p>③ Slide forward the gasket and insert it in the backshell until fully seated.</p> <p>④ Slide forward the strain relief collar and insert it in the backshell, making sure that the opposing protrusions fit inside the corresponding grooves, as shown on the illustration.</p> <p>Note</p> <p>It is critical that the protrusions are inside the corresponding grooves. It may cause breakage, when a tightening collar is assembled.</p> | | | | | | | | | | | | | | | | | | | | | | | | | | | | |
| | <p>⑤</p>  <p>Threaded section</p> <p>Tightening collar</p> | <p>⑤ Verify that the Loctite 7649 primer (or equivalent) on the threaded sections of the backshell and tightening collar are dry. Apply the Loctite 263 compound to the tightening collar's threaded section and attach it to the backshell.</p> | | | | | | | | | | | | | | | | | | | | | | | | | | | | |

| No. | Illustration | Operation | | | | | | | | | | | | |
|------------|-------------------|--|------------|-------------------|--------------|------|----------------|------|------|----------------|------|------|------------------|------|
| 6 | | <p>⑥ Remove the connector from the solder termination fixture, holding it by the locking collar. Do not pull on the cable. It may cause breakage.</p> <table border="1" style="margin-left: auto; margin-right: auto;"> <caption>Recommended tightening torque</caption> <thead> <tr> <th>Shell size</th> <th>Tightening torque</th> <th>Wrench width</th> </tr> </thead> <tbody> <tr> <td>LF07</td> <td>0.8N·m to 1N·m</td> <td>10mm</td> </tr> <tr> <td>LF10</td> <td>0.7N·m to 1N·m</td> <td>14mm</td> </tr> <tr> <td>LF13</td> <td>1 N·m to 1.5 N·m</td> <td>16mm</td> </tr> </tbody> </table> | Shell size | Tightening torque | Wrench width | LF07 | 0.8N·m to 1N·m | 10mm | LF10 | 0.7N·m to 1N·m | 14mm | LF13 | 1 N·m to 1.5 N·m | 16mm |
| Shell size | Tightening torque | Wrench width | | | | | | | | | | | | |
| LF07 | 0.8N·m to 1N·m | 10mm | | | | | | | | | | | | |
| LF10 | 0.7N·m to 1N·m | 14mm | | | | | | | | | | | | |
| LF13 | 1 N·m to 1.5 N·m | 16mm | | | | | | | | | | | | |
| 7 | | <p>Confirmation of Waterproof Performance After connector assembly procedure is completed, compress air in to the connector from the mating side under 17.6 kPa for 30 seconds check that no air leaks out of the connector.</p> | | | | | | | | | | | | |

◆ Cable Specifications (Reference)

| No. of contact | 3 pos. | 4 pos. | 6 pos. | 12 pos. | 20 pos. | 11 pos. | | | |
|----------------|----------------|--------------------|--------------------|-------------------|-------------------|-------------------|--------------------|-----------------------------|--|
| Conductor | Material | | | | | | | Tin plated soft copper wire | |
| | Size (mm) | φ0.18 | φ0.26 | φ0.16 | φ0.16 | φ0.16 | φ0.26 | φ0.16 | |
| | Construction | 20 / φ0.18 mm dia. | 20 / φ0.26 mm dia. | 7 / φ0.16 mm dia. | 7 / φ0.16 mm dia. | 7 / φ0.16 mm dia. | 26 / φ0.26 mm dia. | 7 / φ0.16 mm dia. | |
| | Size (AWG) | 20 AWG | 16 AWG | 26 AWG | 26 AWG | 26 AWG | 16 AWG | 26 AWG | |
| | Sectional area | 0.5 | 1.25 | 0.14 | 0.14 | 0.14 | 1.25 | 0.14 | |
| Insulator | Diameter (mm) | φ0.98 | φ1.5 | φ0.48 | φ0.48 | φ0.48 | φ1.5 | φ0.48 | |
| | Thickness (mm) | φ1.5 (Standard) | φ2.1 (Standard) | φ0.88 (Standard) | φ0.9 (Standard) | φ0.9 (Standard) | φ2.1 (Standard) | φ0.95 (Standard) | |
| Shield | Material | | | | | | | Tin plated soft copper wire | |
| | Density | 85% | 80% or more | 85% | 80% or more | 80% or more | 80% or more | | |
| | Diameter (mm) | φ3.6 | φ5.5 | φ3.4 | φ4.2 | φ5.1 | φ6.7 | | |
| Jacket | Diameter (mm) | φ5±0.2 | φ7.3±0.2 | φ5±0.2 | φ7.3±0.2 | φ8.7±0.2 | φ8.7±0.2 | | |

Remarks : The cable satisfies required specifications for UL specification.

Notes : The cable pull and twisting strength, waterproof tightness and other characteristics may differ, depending on the cable structure, please confirm before the use.



HIROSE ELECTRIC CO.,LTD.

2-6-3,Nakagawa Chuoh,Tsuzuki-Ku,Yokohama-Shi 224-8540,JAPAN
 TEL: +81-45-620-3526 Fax: +81-45-591-3726
<http://www.hirose.com>
<http://www.hirose-connectors.com>