

HighPowerLED Series Chip on Board

COBD-series

High CRI

【Premium Color Line-up】



High efficacy COB LED package,
well-suited for use in spotlight applications

Features & Benefits

- Chip on Board (COB) solution makes it easy to design in
- Simple assembly reduces manufacturing cost
- Low thermal resistance
- InGaN/GaN MQW LED with long time reliability

Applications

- Spotlight / Downlight
- LED Retrofit Bulbs



Table of Contents

1.	Characteristics	-----	3
2.	Product Code Information	-----	5
3.	Typical Characteristics Graphs	-----	9
4.	Outline Drawing & Dimension	-----	12
5.	Reliability Test Items & Conditions	-----	15
6.	Label Structure	-----	16
7.	Packing structure	-----	17
8.	Precautions in Handling & Use	-----	20

1. Characteristics

a) Absolute Maximum Rating

Item	Symbol	Model	Rating	Unit	Condition
Ambient / Operating Temperature	T_a	-	-40 ~ +105	°C	-
Storage Temperature	T_{stg}	-	-40 ~ +120	°C	-
LED Junction Temperature	T_J	-	140	°C	-
Case Temperature	T_c	-	105	°C	-
Forward Current / Power Dissipation	I_f / P_d	LC013D	920 / 34.5	mA / W	-
		LC016D	1150 / 43.1		-
		LC019D	1380 / 51.8		-
		LC026D	1840 / 69.0		-
		LC033D	2300 / 86.3		-
		LC040D	2760 / 103.5		-
ESD (HBM)	-	-	±2	kV	-
ESD (MM)	-	-	±0.5	kV	-

b) Electro-optical Characteristics (I_f = Sorting Current, $T_J = 85^\circ\text{C}$)

Item	Unit	Model	Rank	Min.	Typ.	Max.
Forward Voltage (V_F)	V	All Model	YH	31.8	34.6	37.5
Color Rendering Index (R_a)	-	All Model	-	95	-	-
		LC013D	-	-	0.85	-
		LC016D	-	-	0.67	-
		LC019D	-	-	0.6	-
		LC026D	-	-	0.47	-
		LC033D	-	-	0.4	-
		LC040D	-	-	0.32	-
		Beam Angle	°	All Model	-	-
Nominal Power (Sorting Current)	W (mA)	LC013D	-	-	12.5 (360)	-
		LC016D	-	-	15.6 (450)	-
		LC019D	-	-	18.7 (540)	-
		LC026D	-	-	24.9 (720)	-
		LC033D	-	-	31.1 (900)	-
		LC040D	-	-	37.4 (1080)	-
		Thermal Resistance (junction to case point)	°C/W			

Notes:

- 1) The COB is tested in pulsed condition at rated test current (10 ms pulse width) and rated temperature ($T_J = T_C = 85^\circ\text{C}$)
- 2) Samsung maintains measurement tolerance of: forward voltage = $\pm 5\%$, CRI = ± 1
Refer to the derating curve, '3. Typical Characteristics Graph' designed within the range.

c) Luminous Flux Characteristics ($I_F = \text{Sorting Current}$)

Model	Nominal CCT (K)	Flux Rank	$T_c = 85\text{ }^\circ\text{C}$ (lm)		
			Min.	Typ.	Max.
LC013D	2700	D2	1161	1223	-
	3000	D2	1221	1285	-
	3500	D2	1270	1337	-
	4000	D2	1310	1379	-
	5000	D2	1321	1390	-
LC016D	2700	D2	1496	1575	-
	3000	D2	1572	1655	-
	3500	D2	1636	1722	-
	4000	D2	1687	1776	-
	5000	D2	1701	1791	-
LC019D	2700	D2	1786	1880	-
	3000	D2	1877	1976	-
	3500	D2	1954	2056	-
	4000	D2	2015	2121	-
	5000	D2	2031	2138	-
LC026D	2700	D2	2346	2470	-
	3000	D2	2466	2596	-
	3500	D2	2566	2701	-
	4000	D2	2646	2786	-
	5000	D2	2669	2809	-
LC033D	2700	D2	2904	3057	-
	3000	D2	3051	3212	-
	3500	D2	3176	3343	-
	4000	D2	3275	3447	-
	5000	D2	3302	3476	-
LC040D	2700	D2	3572	3760	-
	3000	D2	3754	3952	-
	3500	D2	3907	4113	-
	4000	D2	4029	4241	-
	5000	D2	4063	4277	-

Notes:

- 1) The COB is tested in pulsed operating condition at rated test current (10 ms pulse width) and rated temperature ($T_J = T_c = 85\text{ }^\circ\text{C}$).
- 2) Samsung maintains measurement tolerance of: Luminous flux = $\pm 7\%$, CRI = ± 1

2. Product Code Information

1	2	3	4	5	6	7	8	9	10	11	12	13	14	15	16	17	18
S	P	H	W	H	A	H	D	N	G	2	8	Y	Z	R	3	D	2

Digit	PKG Information	Code	Specification
1 2 3	Samsung Package High Power	SPH	
4 5	Color	WH	Warm White (T/U/V/W Ranks)
6	Product Version	A	
7 8	Form Factor	HD	COB
9	Lens Type	N	No lens
10	Wattage or Model	D E F G H K	LC013D LC016D LC019D LC026D LC033D LC040D
11	Internal Code	2	
12	CRI & Sorting Temperature	8	Typ. 95 (85 °C)
13 14	Forward Voltage (V)	YZ	31.8~37.5
15	CCT (K)	W V U T R	2700 K 3000 K 3500 K 4000 K 5000 K
16	MacAdam	1 2 3	MacAdam 1-step MacAdam 2-step MacAdam 3-step
17 18	Luminous Flux	D2	COB D-series Gen.2 level

a) Binning Structure (I_F = Sorting Current, T_J =85 °C)

Model	Nominal CCT (K)	Product Code	V_F Rank	Color Rank	Flux Rank	Flux Range (Φ_v , lm)	
LC013D	2700	SPHWAHDND28YZW1D2	YZ	W1	D2	1161~	
		SPHWAHDND28YZW2D2		W2			
	3000	SPHWAHDND28YZV1D2	YZ	V1	D2	1221~	
		SPHWAHDND28YZV2D2		V2			
	3500	SPHWAHDND28YZU1D2	YZ	U1	D2	1270~	
		SPHWAHDND28YZU2D2		U2			
	4000	SPHWAHDND28YZT1D2	YZ	T1	D2	1310~	
		SPHWAHDND28YZT2D2		T2			
	5000	SPHWAHDND28YZR2D2	YZ	R2	D2	1321~	
		SPHWAHDND28YZR3D2		R3			
	LC016D	2700	SPHWAHDNE28YZW1D2	YZ	W1	D2	1496~
			SPHWAHDNE28YZW2D2		W2		
3000		SPHWAHDNE28YZV1D2	YZ	V1	D2	1572~	
		SPHWAHDNE28YZV2D2		V2			
3500		SPHWAHDNE28YZU1D2	YZ	U1	D2	1636~	
		SPHWAHDNE28YZU2D2		U2			
4000		SPHWAHDNE28YZT1D2	YZ	T1	D2	1687~	
		SPHWAHDNE28YZT2D2		T2			
5000		SPHWAHDNE28YZR2D2	YZ	R2	D2	1701~	
		SPHWAHDNE28YZR3D2		R3			
LC019D		2700	SPHWAHDNF28YZW1D2	YZ	W1	D2	1786~
			SPHWAHDNF28YZW2D2		W2		
	3000	SPHWAHDNF28YZV1D2	YZ	V1	D2	1877~	
		SPHWAHDNF28YZV2D2		V2			
	3500	SPHWAHDNF28YZU1D2	YZ	U1	D2	1954~	
		SPHWAHDNF28YZU2D2		U2			
	4000	SPHWAHDNF28YZT1D2	YZ	T1	D2	2015~	
		SPHWAHDNF28YZT2D2		T2			
	5000	SPHWAHDNF28YZR2D2	YZ	R2	D2	2031~	
		SPHWAHDNF28YZR3D2		R3			

Model	Nominal CCT (K)	Product Code	V _F Rank	Color Rank	Flux Rank	Flux Range (Φ _v , lm)	
LC026D	2700	SPHWAHDNG28YZW1D2	YZ	W1	D2	2346~	
		SPHWAHDNG28YZW2D2		W2			
	3000	SPHWAHDNG28YZV1D2	YZ	V1	D2	2466~	
		SPHWAHDNG28YZV2D2		V2			
	3500	SPHWAHDNG28YZU1D2	YZ	U1	D2	2566~	
		SPHWAHDNG28YZU2D2		U2			
	4000	SPHWAHDNG28YZT1D2	YZ	T1	D2	2646~	
		SPHWAHDNG28YZT2D2		T2			
	5000	SPHWAHDNG28YZR2D2	YZ	R2	D2	2669~	
		SPHWAHDNG28YZR3D2		R3			
	LC033D	2700	SPHWAHDNH28YZW1D2	YZ	W1	D2	2904~
			SPHWAHDNH28YZW2D2		W2		
3000		SPHWAHDNH28YZV1D2	YZ	V1	D2	3051	
		SPHWAHDNH28YZV2D2		V2			
3500		SPHWAHDNH28YZU1D2	YZ	U1	D2	3176~	
		SPHWAHDNH28YZU2D2		U2			
4000		SPHWAHDNH28YZT1D2	YZ	T1	D2	3275~	
		SPHWAHDNH28YZT2D2		T2			
5000		SPHWAHDNH28YZR2D2	YZ	R2	D2	3302~	
		SPHWAHDNH28YZR3D2		R3			
LC040D		2700	SPHWAHDNK28YZW1D2	YZ	W1	D2	3572~
			SPHWAHDNK28YZW2D2		W2		
	3000	SPHWAHDNK28YZV1D2	YZ	V1	D2	3754~	
		SPHWAHDNK28YZV2D2		V2			
	3500	SPHWAHDNK28YZU1D2	YZ	U1	D2	3907~	
		SPHWAHDNK28YZU2D2		U2			
	4000	SPHWAHDNK28YZT1D2	YZ	T1	D2	4029~	
		SPHWAHDNK28YZT2D2		T2			
	5000	SPHWAHDNK28YZR2D2	YZ	R2	D2	4063~	
		SPHWAHDNK28YZR3D2		R3			

b) Chromaticity Region & Coordinates ($I_F = \text{Sorting Current}, T_J = 85^\circ\text{C}$)

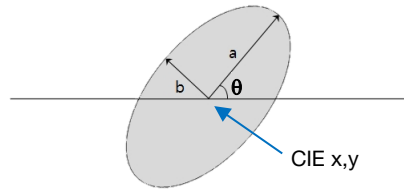
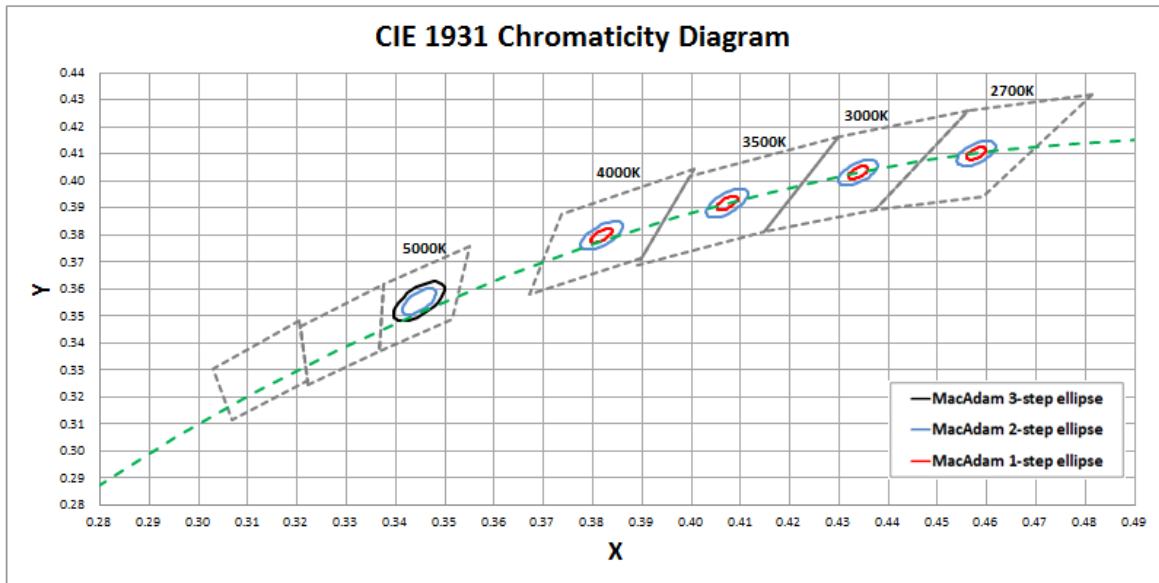

MacAdam Ellipse (W1, W2)					
Step	CIE x	CIE y	θ	a	b
1-step	0.4578	0.4101	53.70	0.0027	0.0014
2-step	0.4578	0.4101	53.70	0.0054	0.0028

MacAdam Ellipse (V1, V2)					
Step	CIE x	CIE y	θ	a	b
1-step	0.4338	0.4030	53.22	0.0028	0.0014
2-step	0.4338	0.4030	53.22	0.0056	0.0027

MacAdam Ellipse (U1, U2)					
Step	CIE x	CIE y	θ	a	b
1-step	0.4073	0.3917	54.00	0.0031	0.0014
2-step	0.4073	0.3917	54.00	0.0062	0.0028

MacAdam Ellipse (T1, T2)					
Step	CIE x	CIE y	θ	a	b
1-step	0.3818	0.3797	53.72	0.0031	0.0013
2-step	0.3818	0.3797	53.72	0.0063	0.0027

MacAdam Ellipse (R3)					
Step	CIE x	CIE y	θ	a	b
2-step	0.3447	0.3553	59.62	0.0055	0.0024
3-step	0.3447	0.3553	59.62	0.0082	0.0035

Note:

Samsung maintains measurement tolerance of: $C_x, C_y = \pm 0.005$

3. Typical Characteristics Graphs

a) Spectrum Distribution (I_F = Sorting Current, $T_J = 85^\circ\text{C}$)

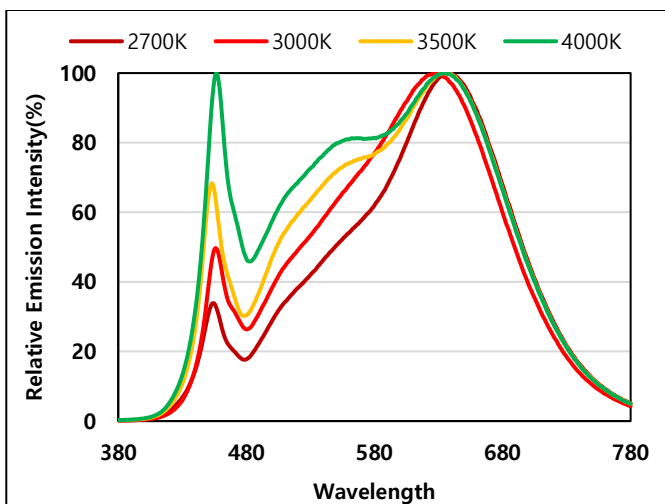

b) Forward Current Characteristics ($T_J = 85^\circ\text{C}$)

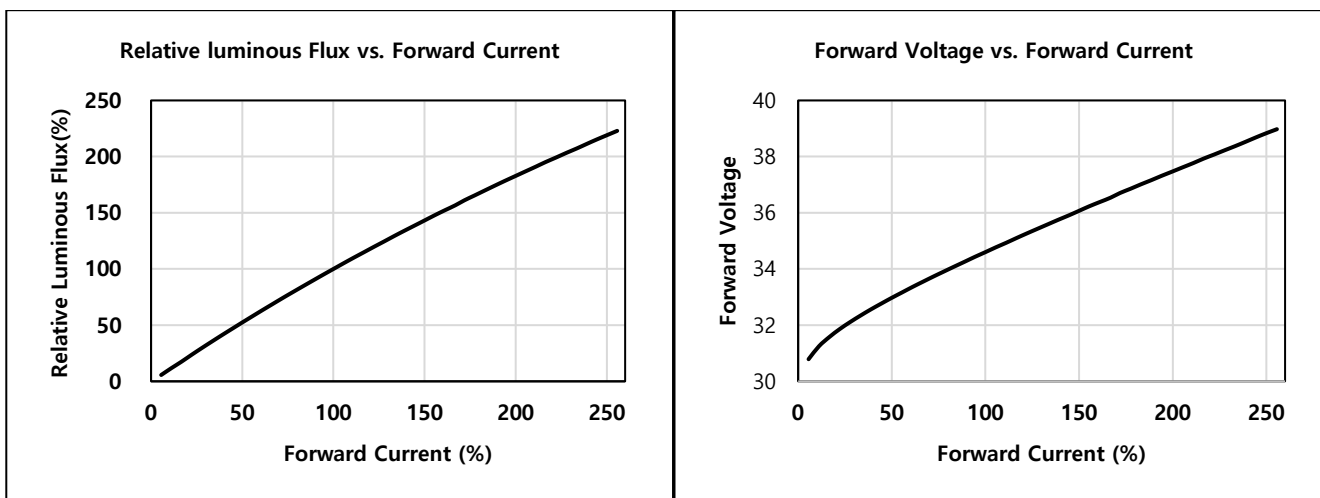

c) Temperature Characteristics (I_F = Sorting Current)

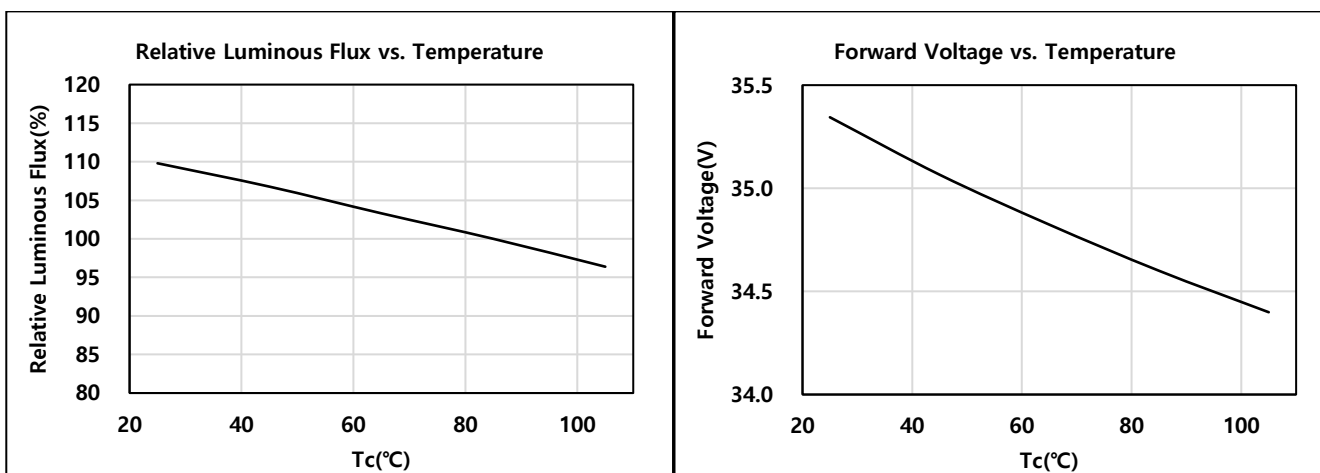

d) Color Shift Characteristics ($T_J = 85\text{ }^\circ\text{C}$, $I_F = \text{Sorting Current}$, $\text{CRI} = 80+$)

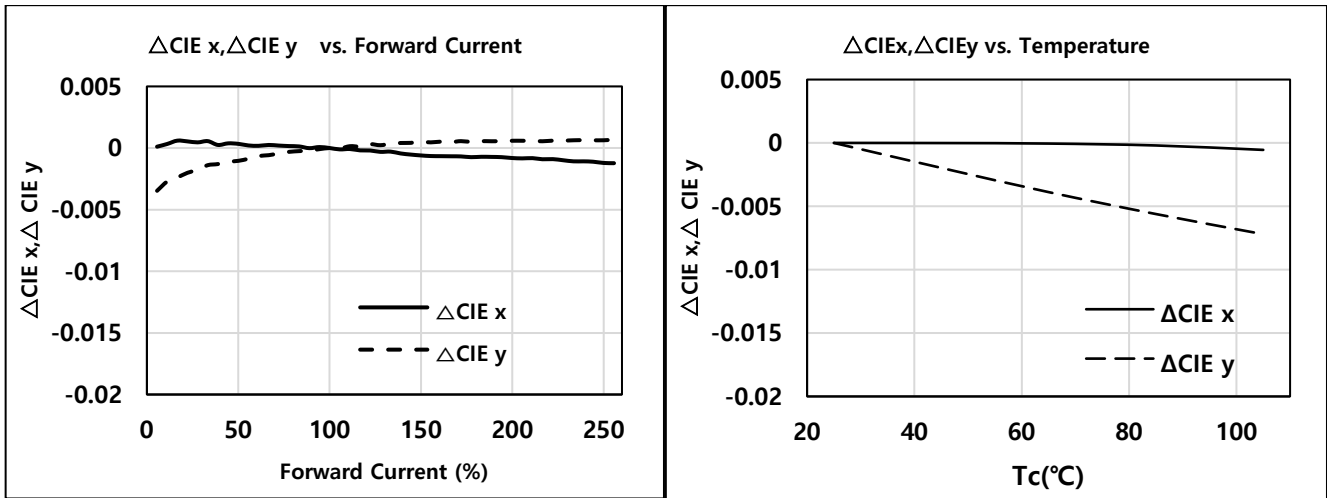

e) Beam Angle Characteristics ($I_F = \text{Sorting Current}$, $T_J = 85\text{ }^\circ\text{C}$)

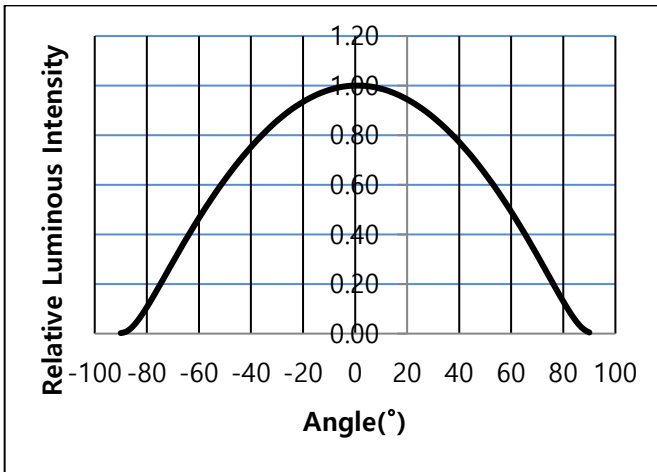

f) Derating Characteristics

1) LC013D

2) LC016D

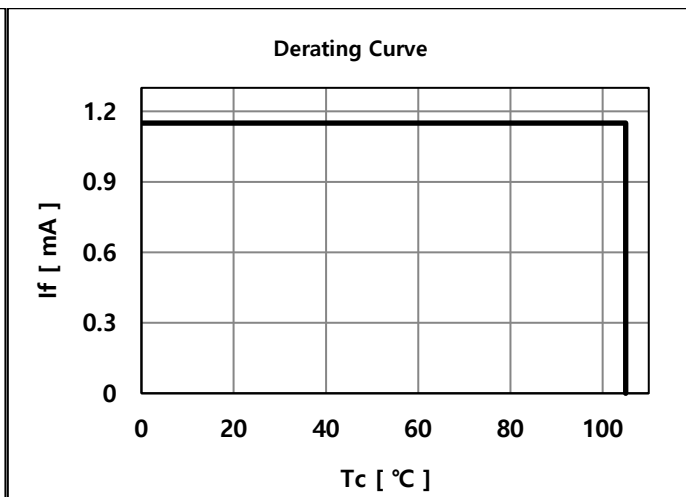
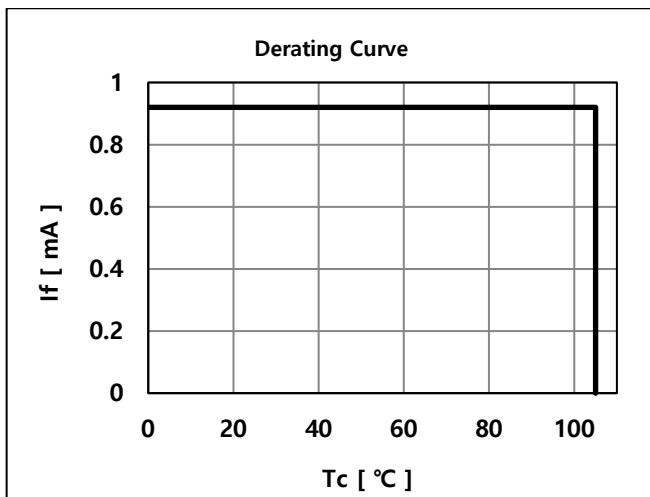

3) LC019D

4) LC026D

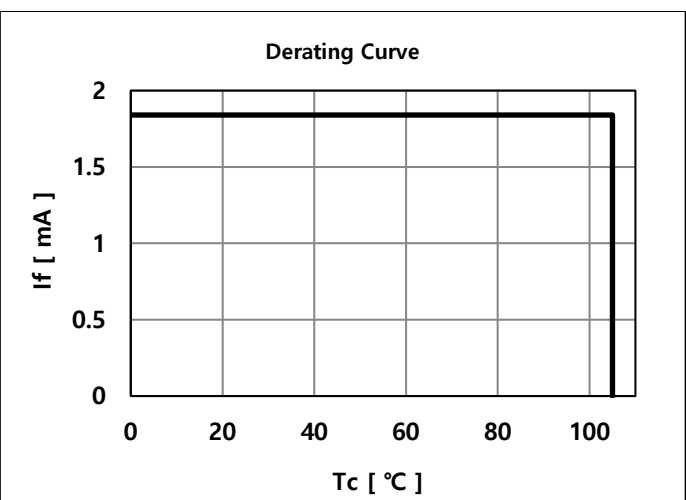
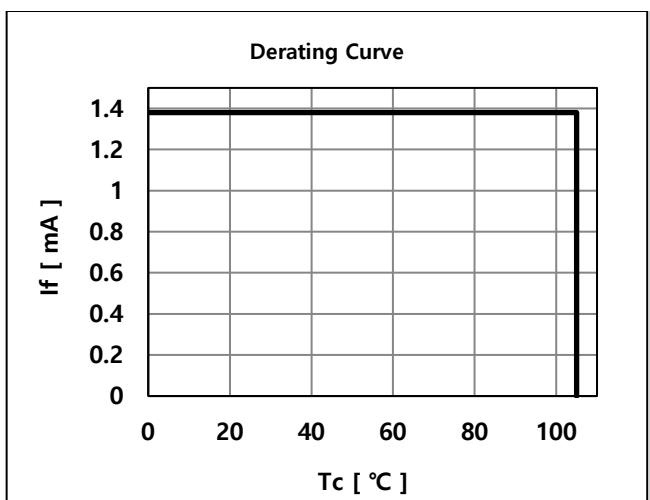

5) LC033D

6) LC040D

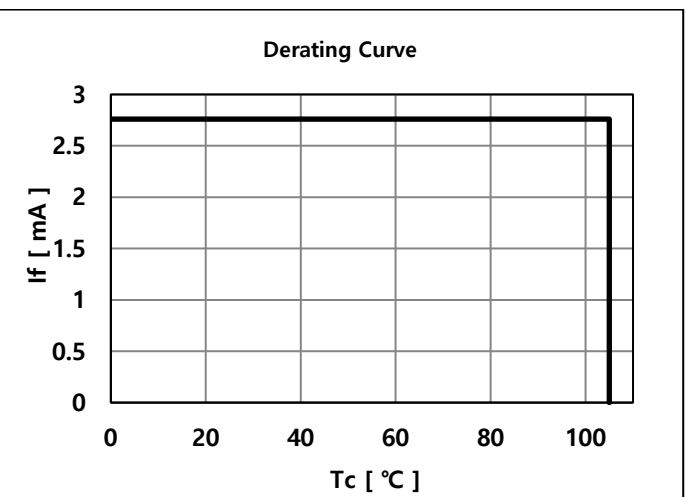
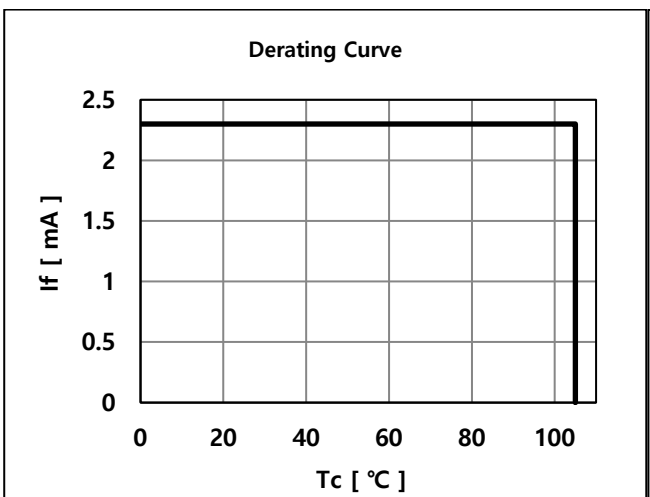

4. Outline Drawing & Dimension

※ Model : LC003D, LC006D, LC009D, LC013D

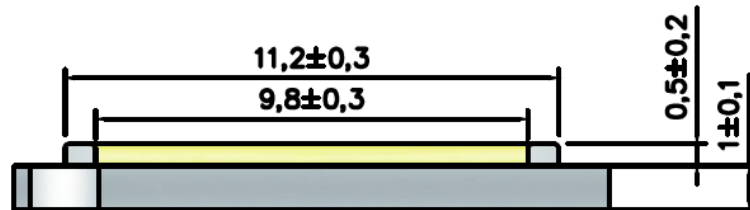
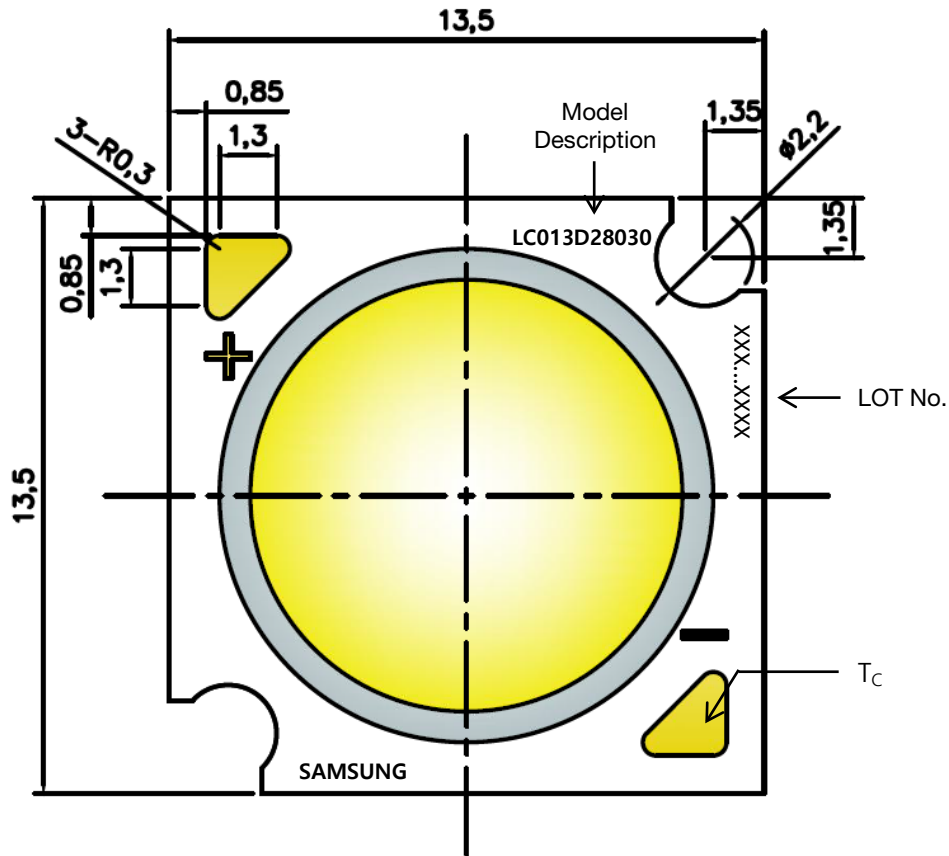

- 1. Unit: mm
- 2. Tolerance: ± 0.3 mm

Item	Dimension	Tolerance	Unit
Length	13.5	±0.20	mm
Width	13.5	±0.20	mm
Height	Dam	0.5	±0.20 mm
	Substrate	1	±0.10 mm
	From the bottom of the substrate to the LES	2	Max mm
LES Diameter	Light Emitting Surface	9.8	±0.30 mm

Note: Denoted product information above is only an example
 (LC013D28030 :LC013D, Gen3, Ra80, 3000K)

※ Model : LC016D, LC019D, LC026D, LC033D

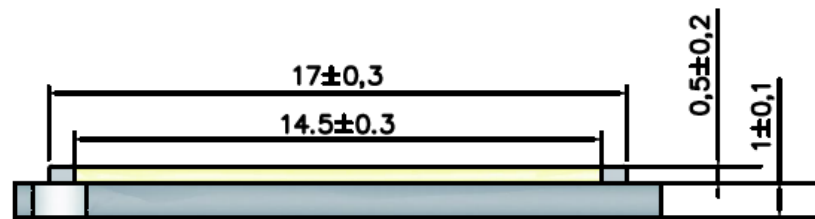
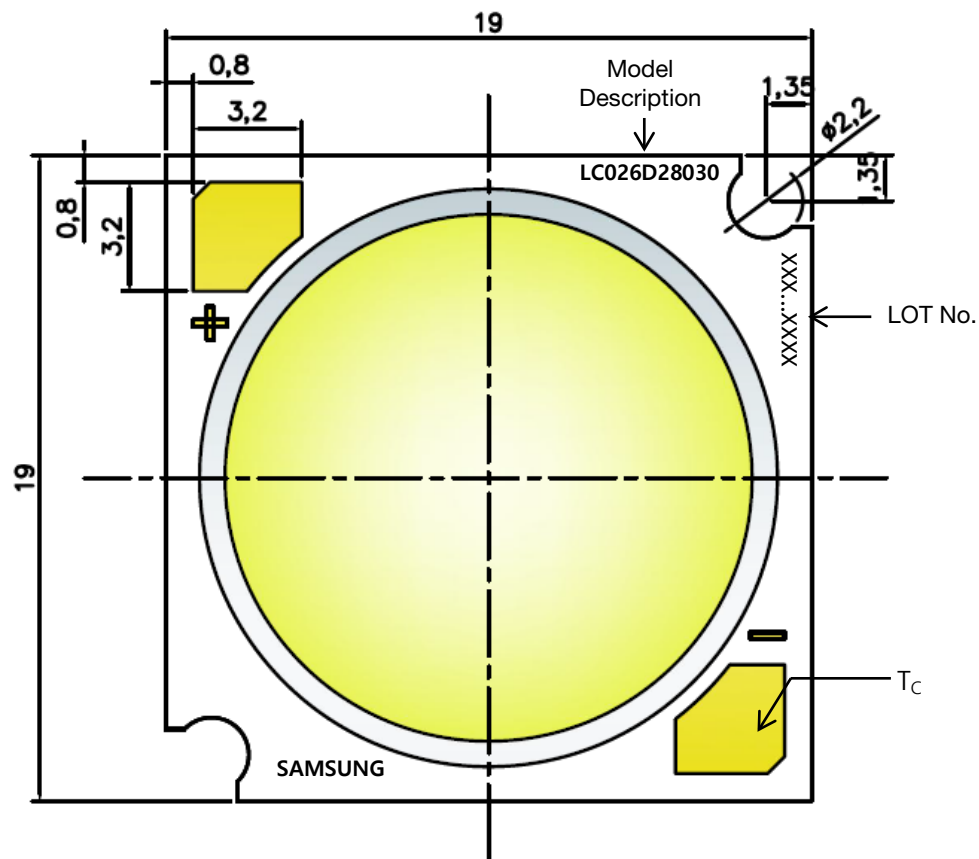

1. Unit: mm
2. Tolerance: ± 0.3 mm

Item	Dimension	Tolerance	Unit
Length	19.0	± 0.20	mm
Width	19.0	± 0.20	mm
Height	Dam	± 0.20	mm
	Substrate	± 0.10	mm
	From the bottom of the substrate to the LES	Max	mm
LES Diameter	Light Emitting Surface	± 0.30	mm

Note: Denoted product information above is only an example
 (LC026D28030 : LC026D, Gen3, CRI80+, 3000K)

※ Model : LC040D, LC060D, LC080D

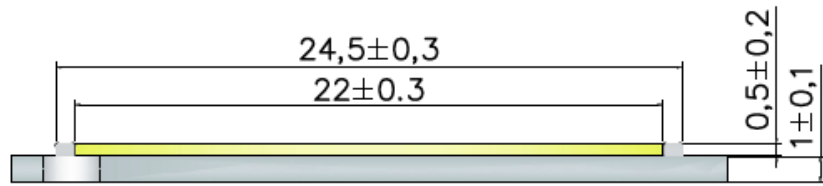
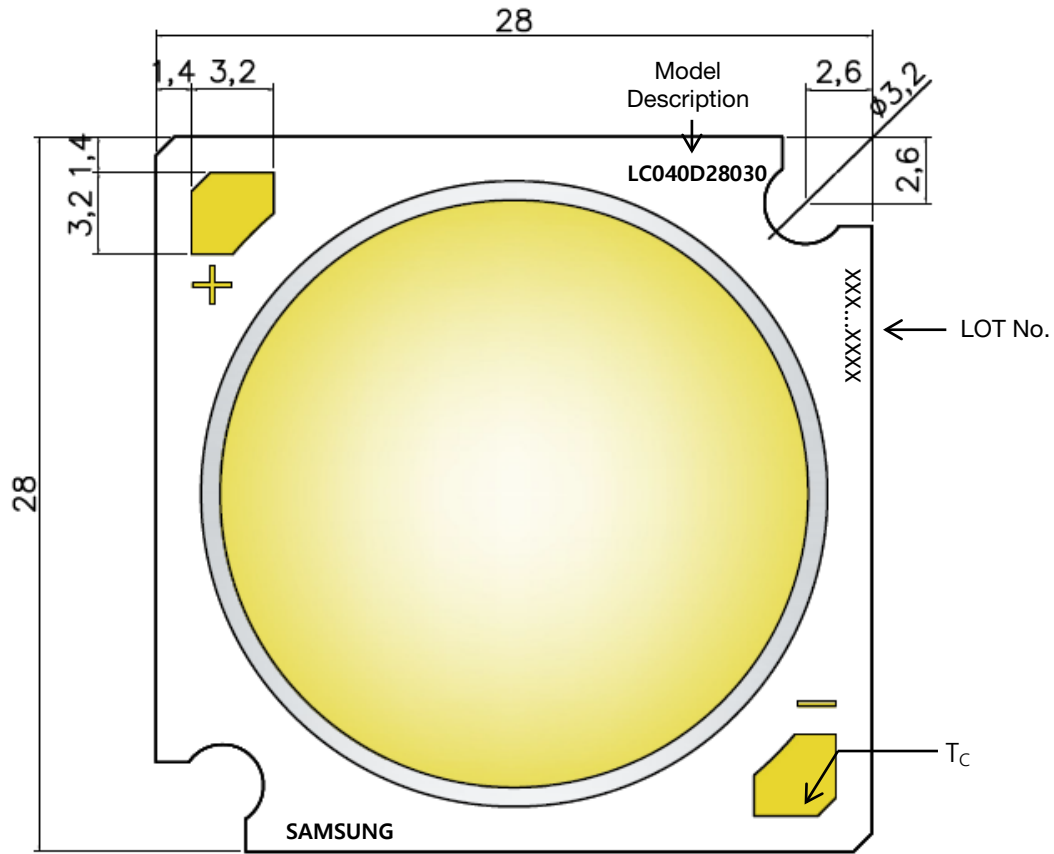

- 1. Unit: mm
- 2. Tolerance: ± 0.3 mm

Item	Dimension	Tolerance	Unit
Length	28.0	±0.20	mm
Width	28.0	±0.20	mm
Height	Dam	0.5	±0.20 mm
	Substrate	1.0	±0.10 mm
	From the bottom of the substrate to the LES	2.0	Max mm
LES Diameter	Light Emitting Surface	22.0	±0.30 mm

Note: Denoted product information above is only an example
 (LC040D28030 : LC040D, Gen2, CRI80+, 3000K)

5. Reliability Test Items & Conditions

a) Test Items

Test Item	Test Condition	Test Hour / Cycle
High Temperature Humidity Life Test	60 °C, 90 % RH,, DC Derating, I_F	1000 h
High Temperature Life Test	85 °C, DC Derating, I_F	1000 h
Low Temperature Life Test	-40 °C, DC, Derating I_F	1000 h
High Temperature Storage	120 °C	1000 h
Low Temperature Storage	-40 °C	1000 h
Temperature Humidity Storage	60 °C, 90% RH	1000h
TemperatureCycle On/Off Test	-40 °C/ 85 °C each 20 min, 30 min transfer power on/off each 5 min, DC Derating, $I_F = \text{max}$	100 cycles
ESD (HBM)	R_1 : 10 M Ω R_2 : 1.5 k Ω C: 100 pF	5 times
ESD (MM)	R_1 : 10 M Ω R_2 : 0 k Ω C: 200 pF	5 times
Vibration Test	20~ 80 Hz (displacement: 0.06 inch, max. 20 g) 80 ~ 2 kHz (max. 20 g) min. frequency ↔max. frequency 4 min transfer	4 times
Mechanical Shock Test	1500g, 0.5 ms each of the 6 surfaces (3 axis x 2 sides)	5 times
Sulfur Resistance	25 °C, 75%, H2S 15 ppm	504h

b) Criteria for Judging the Damage

Item	Symbol	Test Condition ($T_c = 25\text{ °C}$)	Limit	
			Min.	Max.
Forward Voltage	V_F	$I_F = 90\text{ mA}$	L.S.L. * 0.9	U.S.L. * 1.1
Luminous Flux	v	$I_F = 90\text{ mA}$	L.S.L * 0.7	U.S.L * 1.3

6. Label Structure

a) Label Structure

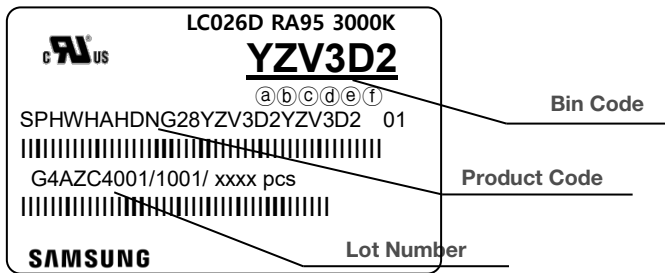

Note: Denoted bincode and product code above is only an example (see description on page 5)

Bin Code:

- ⒶⒷ: Forward Voltagebin (refer to page11)
- ⒸⒹ: Chromaticitybin (refer to page 9-10)
- ⒺⒻ: Luminous Fluxbin (refer to page 6)

b) Lot Number

The lot number is composed of the following characters:

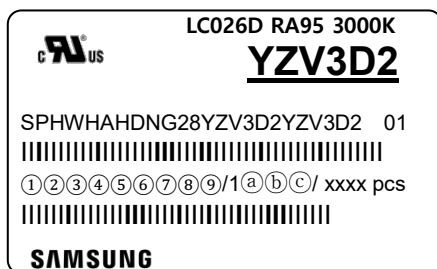

① ③④⑤⑥⑦⑧⑨ / 1ⒶⒷⒸ / xxxx pcs

- ① : Production site (S: Giheung, Korea, G: Tianjin, China)
- ② : 7(LED)
- ③ : Product state (A: Normal, B: Bulk, C: First Production, R: Reproduction, S: Sample)
- ④ : Year (D: 2019, E: 2020, F: 2021...)
- ⑤ : Month (1~9, A, B, C)
- ⑥⑦⑧⑨ : Day (1~9, A, B~V)
- ⒶⒷⒸ : Product serial number (001 ~ 999)

7. Packing Structure

※ Model : LC013D

Packing material	Max. quantity in pcs of COB	Dimension(mm)			
		Length	Width	Height	Tolerance
Tray	50	200	200	8	1
Anti-Static Bag	250 (5 trays)	320	270	-	+/- 0.5
Outer Box (Small)	500 (2 bags)	225	225	65	5
Outer Box (Middle)	1000 (4 bags)	225	225	130	5

a) Packing Structure

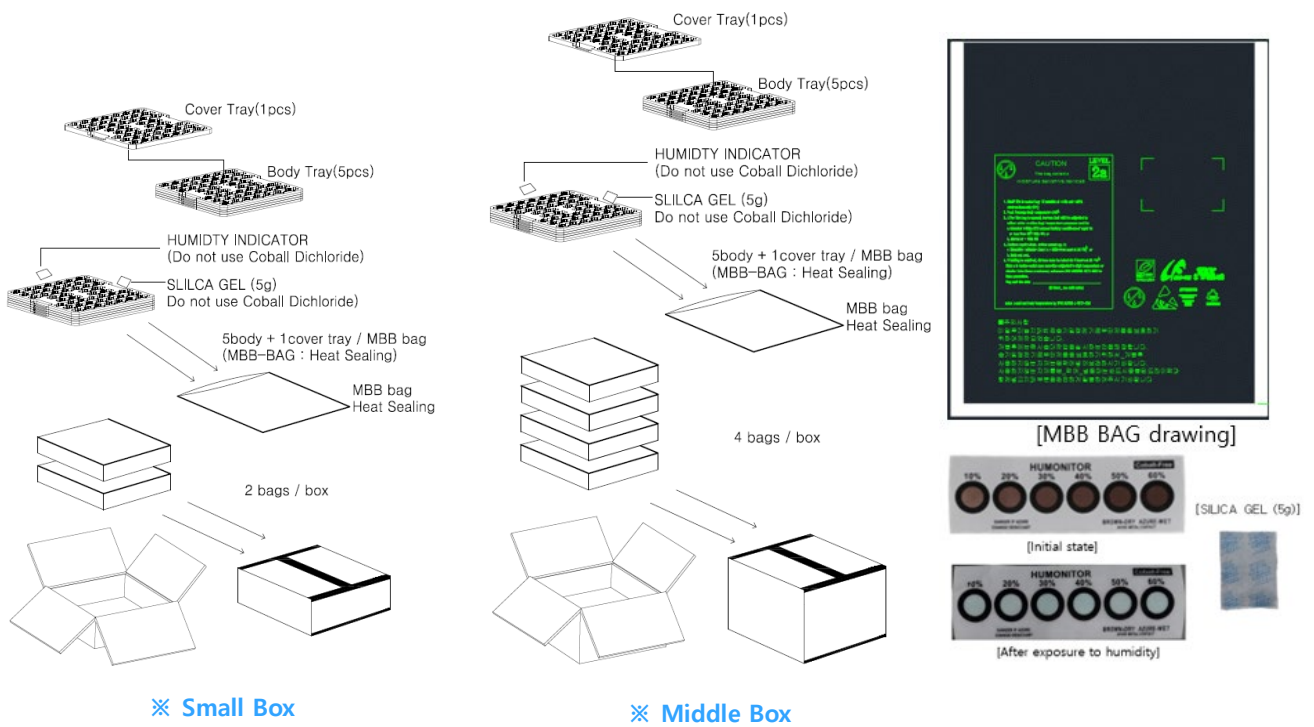

※ Small Box

※ Middle Box

b) Tray

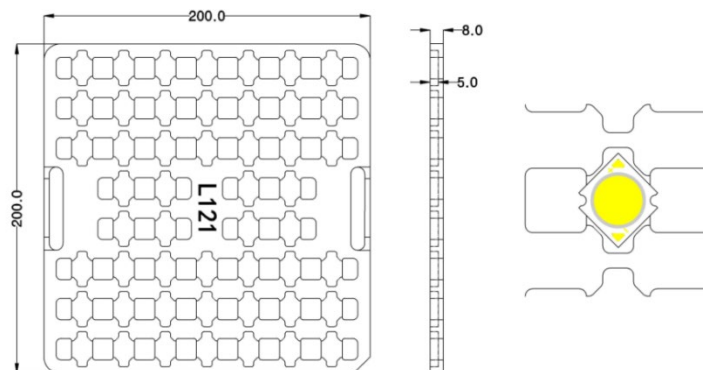

7. Packing Structure

※ Model : LC016D, LC019D, LC026D, LC033D

Packing material	Max. quantity in pcs of COB	Dimension(mm)			
		Length	Width	Height	Tolerance
Tray	25	200	200	8	1
Anti-Static Bag	125 (5 trays)	320	270	-	+/- 0.5
Outer Box (Small)	250 (2 bags)	225	225	65	5
Outer Box (Middle)	500 (4 bags)	225	225	130	5

a) Packing Structure

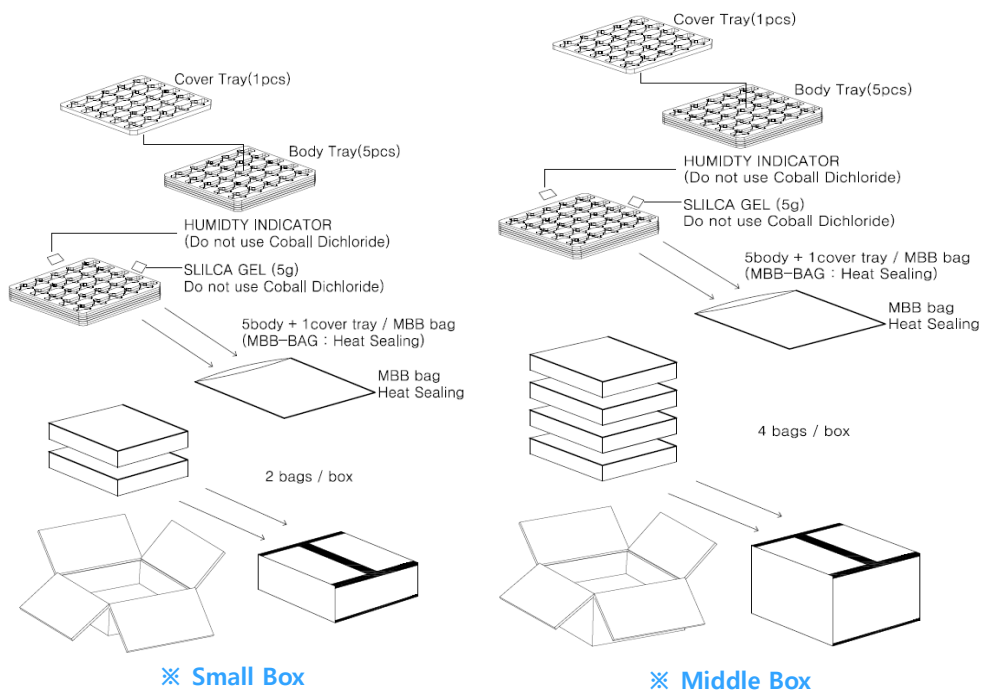

b) Tray

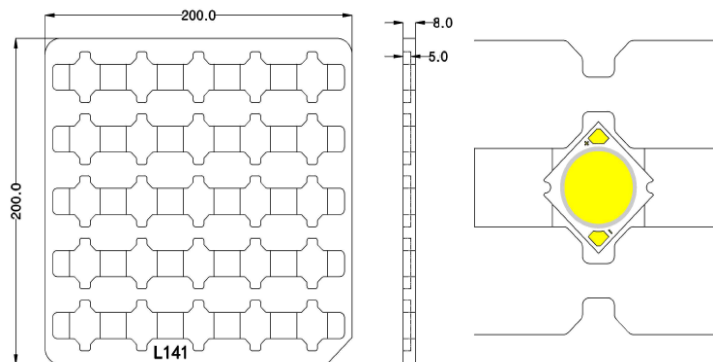

7. Packing Structure

※ Model : LC040D

Packing material	Max. quantity in pcs of COB	Dimension(mm)			
		Length	Width	Height	Tolerance
Tray	16	200	200	8	1
Anti-Static Bag	80 (5 trays)	320	270	-	+/- 0.5
Outer Box (Small)	160 (2 bags)	225	225	65	5
Outer Box (Middle)	320 (4 bags)	225	225	130	5

a) Packing Structure

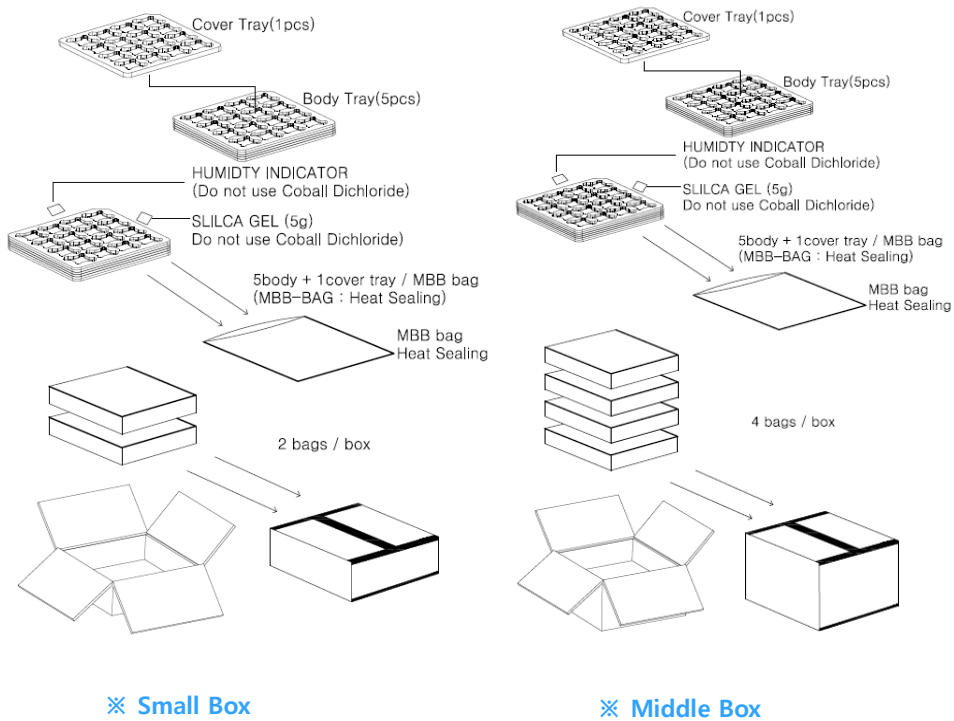

b) Tray

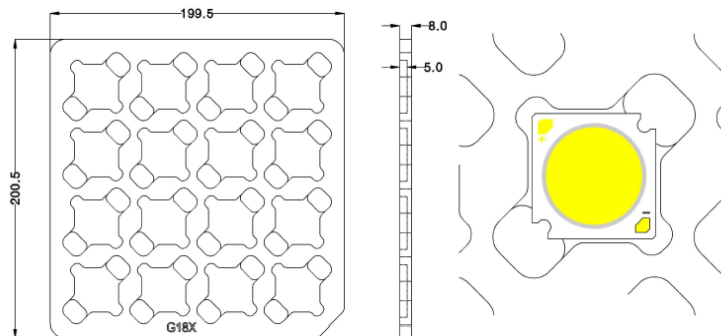

8. Precautions in Handling & Use

- 1) This device should not be used in any type of fluid such as water, oil, organic solvent, etc. Some solvent-based cleaning agent may damage the silicone resins used in the device.
- 2) LEDs must be stored in a clean environment. If the LEDs are to be stored for three months or more after being shipped from Samsung, they should be packed with a nitrogen-filled container (shelf life of sealed bags is 12 months at temperature 0~40 °C, 0~90 % RH).
- 3) After storage bag is opened, device subjected to soldering, solder reflow, or other high temperature processes must be:
 - a. Mounted within 672 hours (28 days) at an assembly line with a condition of no more than 30 °C / 60 % RH, or
 - b. Stored at <10 % RH
- 4) Repack unused products with anti-moisture packing, fold to close any opening and then store in a dry place.
- 5) Devices require baking before mounting, if humidity card reading is >60 % at 23 ± 5 °C.
- 6) Devices must be baked for 1 hour at 60 ± 5 °C, if baking is required.
- 7) The LEDs are sensitive to the static electricity and surge current. It is recommended to use a wrist band or anti-electrostatic glove when handling the LEDs. If voltage exceeding the absolute maximum rating is applied to LEDs, it may cause damage or even destruction to LED devices. Damaged LEDs may show some unusual characteristics such as increase in leakage current, lowered turn-on voltage, or abnormal lighting of LEDs at low current.
- 8) The thermal management is one of the most critical factors for the LED lighting system. Especially the LED junction temperature should not exceed the absolute maximum rating while operation of LED lighting system.
For more information, please refer to Application Note 'Mechanical & Thermal Guide for COB'.
- 9) In case of driving LEDs around the minimum current level (I_{f_min}), chips might exhibit different brightness due to the variation in I-V characteristics of each one. This is normal and does not adversely affect the performance of product.
- 10) VOCs (Volatile Organic Compounds) can be generated from adhesives, flux, hardener or organic additives used in luminaires (fixtures). Transparent LED silicone encapsulant is permeable to those chemicals and they may lead to a discoloration of encapsulant when they exposed to heat or light. This phenomenon can cause a significant loss of light emitted (output) from the luminaires. In order to prevent these problems, we recommend users to know the physical properties of materials used in luminaires and they must be carefully selected.
- 11) The resin area is very sensitive, please do not handle, press, touch, rub, clean, or pick by with tweezers on it. Instead, please pick at the handling area as indicated below.

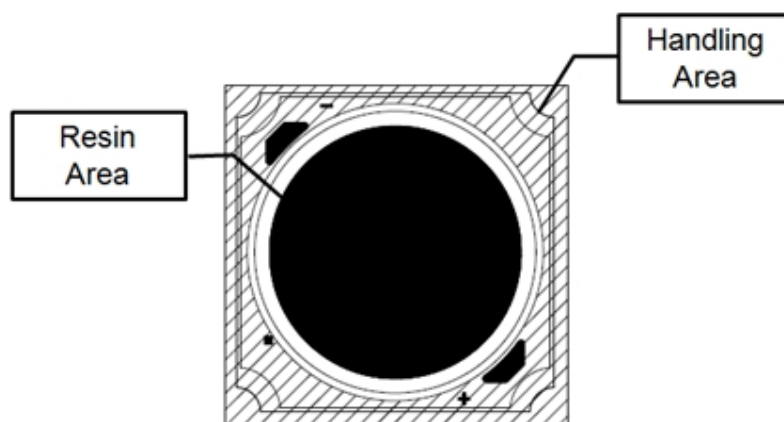

Legal and additional information.

[About Samsung Electronics Co., Ltd.](#)

Samsung Electronics Co., Ltd. inspires the world and shapes the future with transformative ideas and technologies, redefining the worlds of TVs, smartphones, wearable devices, tablets, cameras, digital appliances, printers, medical equipment, network systems and semiconductors.

We are also leading in the Internet of Things space through, among others, our Digital Health and Smart Home initiatives. We employ 307,000 people across 84 countries. To discover more, please visit our official website at www.samsung.com and our official blog at global.samsungtomorrow.com.

Copyright © 2015 Samsung Electronics Co., Ltd. All rights reserved.

Samsung is a registered trademark of Samsung Electronics Co., Ltd.

Specifications and designs are subject to change without notice. Non-metric weights and measurements are approximate. All data were deemed correct at time of creation. Samsung is not liable for errors or omissions. All brand, product, service names and logos are trademarks and/or registered trademarks of their respective owners and are hereby recognized and acknowledged.

Samsung Electronics Co., Ltd.

95, Samsung 2-ro

Giheung-gu

Yongin-si, Gyeonggi-do, 446-711

KOREA

www.samsungled.com

SAMSUNG