



# Product Specification

P270HVN01.0

AU OPTRONICS CORPORATION

( ) Preliminary Specification  
(V) Final Specification

Module	27.0" Color TFT-LCD
Model Name	P270HVN01.0

Customer	Date
_____	_____
Approved by	
_____	_____
Note: This Specification is subject to change without notice.	

Approved by	Date
<u>Jacky Su</u>	<u>2017/01/04</u>
Prepared by	
<u>Lorenz Shiau</u>	<u>2016/12/30</u>
Desktop Display Business Group / AU Optronics Corporation	



## Content

1	HANDLING PRECAUTIONS.....	6
2	GENERAL DESCRIPTION .....	7
2.1	Display Characteristics .....	7
2.2	Optical Characteristics.....	8
3	FUNCTIONAL BLOCK DIAGRAM .....	12
4	ABSOLUTE MAXIMUM RATINGS.....	13
4.1	TFT LCD Module .....	13
4.2	Backlight Unit .....	13
4.3	Absolute Ratings of Environment.....	13
5	ELECTRICAL CHARACTERISTICS .....	15
5.1	TFT LCD Module .....	15
5.1.1	Power Specification.....	15
5.1.2	Signal Electrical Characteristics .....	17
5.2	Backlight Unit .....	19
6	SIGNAL CHARACTERISTICS .....	20
6.1	Pixel Format Definition.....	20
6.2	Input Data Format Definition.....	20
6.3	Signal Description.....	21
6.4	Timing Characteristics .....	23
6.5	Timing Diagram .....	24
6.6	Power ON/OFF Sequence.....	25
7	CONNECTOR AND PIN ASSIGNMENT .....	26
7.1	TFT LCD Module .....	26
7.1.1	Pin Assignment .....	26
7.2	LED Connector on Backlight Unit .....	27
7.2.1	LED Pin assignment.....	27
7.2.2	LED Connector Dimension.....	28
7.2.3	LED Mating housing dimension.....	28
8	RELIABILITY TEST .....	29
9	SHIPPING LABEL .....	30
10	MECHANICAL CHARACTERISTICS.....	31
11	PACKING SPECIFICATION .....	34
11.1	Packing Flow .....	34
11-2	Pallet and shipment information .....	35

## Records of Revision

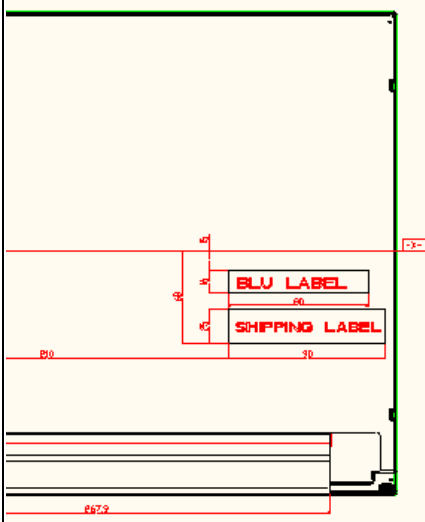
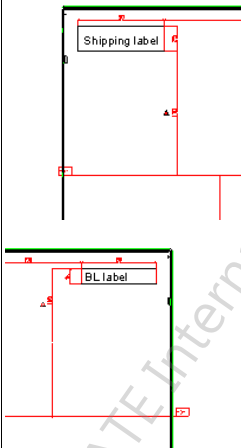
Version and Date	Page	Old description	New Description	Remark				
0.1 2012/05/10		First Version						
0.2 2012/06/15	14, 18		To Define TFT LCD power spec To Define BL Power spec					
0.3 2012/06/20	6		To Define Panel Weight					
0.3 2012/06/20	31		<p>To Change the Label position. BLU Label is at the upper right (corner). Shipping label is at the the upper left (corner).</p> 					
0.4 2012/06/29	14	Verison 0.3 , the absolute VDD maximum is 5.5V of the module	Verison 0.4 , Update the absolute VDD maximum is 6.0V of the module					
0.5 2012/07/12	6, 7, 14,	In Verison 0.4 , Surface Treatment , Color/Chromaticity , absolute rating as TBD .	To Define the Surface Treatment To Define Color / Chromaticity (should be confirm again) To Define the Absolute Maximum Ratings of BL unit					
0.5 2012/07/12	23, 19	In Verison 0.4 , the Max clock is 85MHz. In Verison 0.4 , the VLB minmun doesn't defined.	To upgrade the Max clock frequency as 90MHz. To define the VLB minnum voltage .					
0.6 2012/07/25	6		To correct the model name as P270HVN01.0					
0.7 2012/08/20	6	<table border="1" data-bbox="440 1835 867 1919"> <tr> <td>[Watt]</td> <td>29.34 watt VDD line : PDD (typ), All white pattern at 60Hz = 5.94 W LED line : PBLU (typ) = 23.4 W</td> </tr> </table>	[Watt]	29.34 watt VDD line : PDD (typ), All white pattern at 60Hz = 5.94 W LED line : PBLU (typ) = 23.4 W	<p>To modify the Panel Power Consumption</p> <table border="1" data-bbox="873 1885 1317 1967"> <tr> <td>[Watt]</td> <td>27.72 watt VDD line : PDD (typ), All white pattern at 60Hz = 5.94 w LED line : PBLU (typ) = 21.78 W</td> </tr> </table>	[Watt]	27.72 watt VDD line : PDD (typ), All white pattern at 60Hz = 5.94 w LED line : PBLU (typ) = 21.78 W	
[Watt]	29.34 watt VDD line : PDD (typ), All white pattern at 60Hz = 5.94 W LED line : PBLU (typ) = 23.4 W							
[Watt]	27.72 watt VDD line : PDD (typ), All white pattern at 60Hz = 5.94 w LED line : PBLU (typ) = 21.78 W							



<p>0.7 2012/08/20</p>	<p>7</p>	<table border="1"> <tr> <td>Red x</td> <td>0.612</td> <td>0.642</td> <td>0.672</td> </tr> <tr> <td>Red y</td> <td>0.304</td> <td>0.334</td> <td>0.364</td> </tr> <tr> <td>Green x</td> <td>0.292</td> <td>0.322</td> <td>0.352</td> </tr> <tr> <td>Green y</td> <td>0.594</td> <td>0.624</td> <td>0.654</td> </tr> <tr> <td>Blue x</td> <td>0.126</td> <td>0.156</td> <td>0.186</td> </tr> <tr> <td>Blue y</td> <td>0.030</td> <td>0.060</td> <td>0.090</td> </tr> </table>	Red x	0.612	0.642	0.672	Red y	0.304	0.334	0.364	Green x	0.292	0.322	0.352	Green y	0.594	0.624	0.654	Blue x	0.126	0.156	0.186	Blue y	0.030	0.060	0.090	<p>To modify the Color / Chromaticity Coordinates (CIE)</p> <table border="1"> <tr> <td>Red x</td> <td>0.615</td> <td>0.645</td> <td>0.675</td> </tr> <tr> <td>Red y</td> <td>0.300</td> <td>0.330</td> <td>0.360</td> </tr> <tr> <td>Green x</td> <td>0.285</td> <td>0.315</td> <td>0.345</td> </tr> <tr> <td>Green y</td> <td>0.590</td> <td>0.620</td> <td>0.650</td> </tr> <tr> <td>Blue x</td> <td>0.124</td> <td>0.154</td> <td>0.184</td> </tr> <tr> <td>Blue y</td> <td>0.034</td> <td>0.064</td> <td>0.094</td> </tr> </table>	Red x	0.615	0.645	0.675	Red y	0.300	0.330	0.360	Green x	0.285	0.315	0.345	Green y	0.590	0.620	0.650	Blue x	0.124	0.154	0.184	Blue y	0.034	0.064	0.094									
Red x	0.612	0.642	0.672																																																									
Red y	0.304	0.334	0.364																																																									
Green x	0.292	0.322	0.352																																																									
Green y	0.594	0.624	0.654																																																									
Blue x	0.126	0.156	0.186																																																									
Blue y	0.030	0.060	0.090																																																									
Red x	0.615	0.645	0.675																																																									
Red y	0.300	0.330	0.360																																																									
Green x	0.285	0.315	0.345																																																									
Green y	0.590	0.620	0.650																																																									
Blue x	0.124	0.154	0.184																																																									
Blue y	0.034	0.064	0.094																																																									
<p>0.7 2012/08/20</p>	<p>18</p>	<table border="1"> <thead> <tr> <th>Symbol</th> <th>Description</th> <th>Min.</th> <th>Typ.</th> <th>Max.</th> <th>Unit</th> <th>Note</th> </tr> </thead> <tbody> <tr> <td>IRLED</td> <td>LED Operation Current</td> <td>-</td> <td>120</td> <td>120</td> <td>[mA]</td> <td>Note 1</td> </tr> <tr> <td>VLB</td> <td>Light Bar Operation Voltage (for reference)</td> <td>44.25</td> <td>48.75</td> <td>53.25</td> <td>[V<sub>0A</sub>]</td> <td>Note 2</td> </tr> <tr> <td>PBLU</td> <td>BLU Power Consumption (for reference)</td> <td>-</td> <td>23.4</td> <td>25.3</td> <td>[Watt]</td> <td>Note 3</td> </tr> </tbody> </table>	Symbol	Description	Min.	Typ.	Max.	Unit	Note	IRLED	LED Operation Current	-	120	120	[mA]	Note 1	VLB	Light Bar Operation Voltage (for reference)	44.25	48.75	53.25	[V <sub>0A</sub> ]	Note 2	PBLU	BLU Power Consumption (for reference)	-	23.4	25.3	[Watt]	Note 3	<p>To modify the BLU power spec</p> <table border="1"> <thead> <tr> <th>Symbol</th> <th>Description</th> <th>Min.</th> <th>Typ.</th> <th>Max.</th> <th>Unit</th> <th>Note</th> </tr> </thead> <tbody> <tr> <td>IRLED</td> <td>LED Operation Current</td> <td>-</td> <td>110</td> <td>115.5</td> <td>[mA]</td> <td>Note 1</td> </tr> <tr> <td>VLE</td> <td>Light Bar Operation Voltage (for reference)</td> <td>44.25</td> <td>49.5</td> <td>54</td> <td>[V<sub>0A</sub>]</td> <td>Note 2</td> </tr> <tr> <td>PBLU</td> <td>BLU Power Consumption (for reference)</td> <td>-</td> <td>21.78</td> <td>24.95</td> <td>[Watt]</td> <td>Note 3</td> </tr> </tbody> </table>	Symbol	Description	Min.	Typ.	Max.	Unit	Note	IRLED	LED Operation Current	-	110	115.5	[mA]	Note 1	VLE	Light Bar Operation Voltage (for reference)	44.25	49.5	54	[V <sub>0A</sub> ]	Note 2	PBLU	BLU Power Consumption (for reference)	-	21.78	24.95	[Watt]	Note 3	
Symbol	Description	Min.	Typ.	Max.	Unit	Note																																																						
IRLED	LED Operation Current	-	120	120	[mA]	Note 1																																																						
VLB	Light Bar Operation Voltage (for reference)	44.25	48.75	53.25	[V <sub>0A</sub> ]	Note 2																																																						
PBLU	BLU Power Consumption (for reference)	-	23.4	25.3	[Watt]	Note 3																																																						
Symbol	Description	Min.	Typ.	Max.	Unit	Note																																																						
IRLED	LED Operation Current	-	110	115.5	[mA]	Note 1																																																						
VLE	Light Bar Operation Voltage (for reference)	44.25	49.5	54	[V <sub>0A</sub> ]	Note 2																																																						
PBLU	BLU Power Consumption (for reference)	-	21.78	24.95	[Watt]	Note 3																																																						
<p>0.7 2012/08/20</p>	<p>13</p>	<p>VDD minimum is 0V LED forward Voltage variation(ΔVf) is 6V</p>	<p>To modify the VDD minimum as -0.3V LED forward Voltage variation(ΔVf) as 3V</p>																																																									
<p>1.0 2012/10/08</p>	<p>6</p>	<p>The 0.7 version power consumption is 27.72W</p>	<p>Update the power consumption 26.88W</p>																																																									
	<p>6</p>		<p>TCO Compliance :TCO 6.0</p>																																																									
	<p>14</p>		<p>To Define Max. Value IDD1 and PDD1</p>																																																									
	<p>22</p>		<p>Add Hsync Frequency</p>																																																									
<p>1.1 2012/12/4</p>	<p>34</p>		<p>To Modify the Ch 11-2 Panel dimension with 613.6(H)mm x 356.85(V)mm x 10(D)mm</p>																																																									
	<p>18</p>		<p>To Correct the Note3 , VLED changed VLB</p>																																																									
	<p>20/21/25</p>	<table border="1"> <thead> <tr> <th>Pin#</th> <th>Signal Name</th> <th>Pin#</th> <th>Signal Name</th> </tr> </thead> <tbody> <tr> <td>1</td> <td>RxOIN0-</td> <td>2</td> <td>RxOIN0+</td> </tr> <tr> <td>3</td> <td>RxOIN1-</td> <td>4</td> <td>RxOIN1+</td> </tr> <tr> <td>5</td> <td>RxOIN2-</td> <td>6</td> <td>RxOIN2+</td> </tr> <tr> <td>7</td> <td>GND</td> <td>8</td> <td>RxOCLKIN-</td> </tr> <tr> <td>9</td> <td>RxOCLKIN+</td> <td>10</td> <td>RxOIN3-</td> </tr> <tr> <td>11</td> <td>RxOIN3+</td> <td>12</td> <td>RxOIN3-</td> </tr> </tbody> </table>	Pin#	Signal Name	Pin#	Signal Name	1	RxOIN0-	2	RxOIN0+	3	RxOIN1-	4	RxOIN1+	5	RxOIN2-	6	RxOIN2+	7	GND	8	RxOCLKIN-	9	RxOCLKIN+	10	RxOIN3-	11	RxOIN3+	12	RxOIN3-	<p>Re-named the LVDS Signal</p> <table border="1"> <thead> <tr> <th>Pin#</th> <th>Signal Name</th> <th>Pin#</th> <th>Signal Name</th> </tr> </thead> <tbody> <tr> <td>1</td> <td>RxO0-</td> <td>2</td> <td>RxO0+</td> </tr> <tr> <td>3</td> <td>RxO1-</td> <td>4</td> <td>RxO1+</td> </tr> <tr> <td>5</td> <td>RxO2-</td> <td>6</td> <td>RxO2+</td> </tr> <tr> <td>7</td> <td>GND</td> <td>8</td> <td>RxOCLK-</td> </tr> <tr> <td>9</td> <td>RxOCLK+</td> <td>10</td> <td>RxO3-</td> </tr> <tr> <td>11</td> <td>RxO3+</td> <td>12</td> <td>RxO3-</td> </tr> </tbody> </table>	Pin#	Signal Name	Pin#	Signal Name	1	RxO0-	2	RxO0+	3	RxO1-	4	RxO1+	5	RxO2-	6	RxO2+	7	GND	8	RxOCLK-	9	RxOCLK+	10	RxO3-	11	RxO3+	12	RxO3-	
Pin#	Signal Name	Pin#	Signal Name																																																									
1	RxOIN0-	2	RxOIN0+																																																									
3	RxOIN1-	4	RxOIN1+																																																									
5	RxOIN2-	6	RxOIN2+																																																									
7	GND	8	RxOCLKIN-																																																									
9	RxOCLKIN+	10	RxOIN3-																																																									
11	RxOIN3+	12	RxOIN3-																																																									
Pin#	Signal Name	Pin#	Signal Name																																																									
1	RxO0-	2	RxO0+																																																									
3	RxO1-	4	RxO1+																																																									
5	RxO2-	6	RxO2+																																																									
7	GND	8	RxOCLK-																																																									
9	RxOCLK+	10	RxO3-																																																									
11	RxO3+	12	RxO3-																																																									
<p>1.2 2012/12/27</p>	<p>12/18/26</p>	<p>Old naming</p> <table border="1"> <thead> <tr> <th>Symbol</th> <th>Description</th> </tr> </thead> <tbody> <tr> <td>IRLED1</td> <td rowspan="4">LED Forward Current</td> </tr> <tr> <td>IRLED2</td> </tr> <tr> <td>IRLED3</td> </tr> <tr> <td>IRLED4</td> </tr> <tr> <td>VLB</td> <td>Light Bar Operation Voltage (for reference)</td> </tr> </tbody> </table>	Symbol	Description	IRLED1	LED Forward Current	IRLED2	IRLED3	IRLED4	VLB	Light Bar Operation Voltage (for reference)	<p>New naming :</p> <table border="1"> <thead> <tr> <th>Symbol</th> <th>Description</th> </tr> </thead> <tbody> <tr> <td>IFLED1</td> <td rowspan="4">LED Forward Current</td> </tr> <tr> <td>IFLED2</td> </tr> <tr> <td>IFLED3</td> </tr> <tr> <td>IFLED4</td> </tr> <tr> <td>VSLED</td> <td>Light Bar Operation Voltage (for reference)</td> </tr> </tbody> </table>	Symbol	Description	IFLED1	LED Forward Current	IFLED2	IFLED3	IFLED4	VSLED	Light Bar Operation Voltage (for reference)																																							
Symbol	Description																																																											
IRLED1	LED Forward Current																																																											
IRLED2																																																												
IRLED3																																																												
IRLED4																																																												
VLB	Light Bar Operation Voltage (for reference)																																																											
Symbol	Description																																																											
IFLED1	LED Forward Current																																																											
IFLED2																																																												
IFLED3																																																												
IFLED4																																																												
VSLED	Light Bar Operation Voltage (for reference)																																																											
<p>1.3 2013/2/26</p>	<p>7</p>		<p>To define the maximum value of response time</p>																																																									
<p>1.4 2013/4/12</p>	<p>20/25</p>	<p>Pin25/Pin 27 is ground pin</p>	<p>Re-define the Pin assignment Pin25/Pin27 as NC</p>																																																									

1.5 2013/5/6	31/32 /33	Without shading mylar on front bezel surface	Adding mylar on front bezel surface																																																																																																	
	19	Maxmium of Power is 24.95	Recommendation for LED driver power design: To Modify the Maxmium of Power is 23.76																																																																																																	
	34/35	To modify the pallet and shipment information, before the packing box is 9pcs/Box and the weight of pallet of packing is 216kg.	After modifying , the packing box is 10pcs/Box and the weight of pallet of packing is 229.94kg.																																																																																																	
2.0 2014/8/4	7	White Luminance ( Center )350 cd/m2 (Typ.) @ 110mA 300 cd/m2 (Typ.) @ 100mA	White Luminance ( Center )=300nits																																																																																																	
	14	<table border="1"> <thead> <tr> <th>Symbol</th> <th>Description</th> <th>Min.</th> <th>Typ.</th> <th>Max.</th> <th>Unit</th> <th>Remark</th> </tr> </thead> <tbody> <tr> <td>I<sub>F</sub></td> <td>LED String Current</td> <td>-</td> <td>110</td> <td>115.5</td> <td>[mA]</td> <td>100% duty ratio of LED chip</td> </tr> <tr> <td>V<sub>s</sub></td> <td>LED String Voltage</td> <td>44.25</td> <td>49.5</td> <td>54</td> <td>[Volt]</td> <td>Isr=60mA @ 100% duty ratio, Note 4-1, Note 4-5</td> </tr> <tr> <td>ΔV<sub>s</sub></td> <td>Maximum V<sub>s</sub> Voltage Deviation of single bar</td> <td>-</td> <td>-</td> <td>3</td> <td>[Volt]</td> <td>Isr=60mA @ 100% duty ratio, Note 4-2</td> </tr> <tr> <td>P<sub>LED</sub></td> <td>LED Light Bar Power Consumption</td> <td>-</td> <td>21.78</td> <td>23.76</td> <td>[Watt]</td> <td>Note 4-3</td> </tr> <tr> <td>LT<sub>LED</sub></td> <td>LED Life Time</td> <td>30,000</td> <td>-</td> <td>-</td> <td>[Hour]</td> <td>Note 4-4</td> </tr> </tbody> </table>	Symbol	Description	Min.	Typ.	Max.	Unit	Remark	I <sub>F</sub>	LED String Current	-	110	115.5	[mA]	100% duty ratio of LED chip	V <sub>s</sub>	LED String Voltage	44.25	49.5	54	[Volt]	Isr=60mA @ 100% duty ratio, Note 4-1, Note 4-5	ΔV <sub>s</sub>	Maximum V <sub>s</sub> Voltage Deviation of single bar	-	-	3	[Volt]	Isr=60mA @ 100% duty ratio, Note 4-2	P <sub>LED</sub>	LED Light Bar Power Consumption	-	21.78	23.76	[Watt]	Note 4-3	LT <sub>LED</sub>	LED Life Time	30,000	-	-	[Hour]	Note 4-4	<table border="1"> <thead> <tr> <th>Symbol</th> <th>Description</th> <th>Min.</th> <th>Typ.</th> <th>Max.</th> <th>Unit</th> <th>Note</th> </tr> </thead> <tbody> <tr> <td>#LED1</td> <td>LED Forward Current</td> <td>-</td> <td>110</td> <td>115.5</td> <td>[mA]</td> <td>Note 1</td> </tr> <tr> <td>#LED2</td> <td>LED Forward Current</td> <td>-</td> <td>110</td> <td>115.5</td> <td>[mA]</td> <td>Note 1</td> </tr> <tr> <td>#LED3</td> <td>LED Forward Current</td> <td>-</td> <td>110</td> <td>115.5</td> <td>[mA]</td> <td>Note 1</td> </tr> <tr> <td>#LED4</td> <td>LED Forward Current</td> <td>-</td> <td>110</td> <td>115.5</td> <td>[mA]</td> <td>Note 1</td> </tr> <tr> <td>V<sub>BL</sub>LED</td> <td>Light Bar Operation Voltage (for reference)</td> <td>44.25</td> <td>49.5</td> <td>54</td> <td>[Volt]</td> <td>Note 2</td> </tr> <tr> <td>P<sub>BLU</sub></td> <td>BLU Power Consumption (for reference)</td> <td>-</td> <td>21.78</td> <td>23.76</td> <td>[Watt]</td> <td>Note 3</td> </tr> <tr> <td>LT<sub>LED</sub></td> <td>LED Life Time (Typical)</td> <td>30,000</td> <td>-</td> <td>-</td> <td>[Hour]</td> <td>Note 4</td> </tr> </tbody> </table>	Symbol	Description	Min.	Typ.	Max.	Unit	Note	#LED1	LED Forward Current	-	110	115.5	[mA]	Note 1	#LED2	LED Forward Current	-	110	115.5	[mA]	Note 1	#LED3	LED Forward Current	-	110	115.5	[mA]	Note 1	#LED4	LED Forward Current	-	110	115.5	[mA]	Note 1	V <sub>BL</sub> LED	Light Bar Operation Voltage (for reference)	44.25	49.5	54	[Volt]	Note 2	P <sub>BLU</sub>	BLU Power Consumption (for reference)	-	21.78	23.76	[Watt]	Note 3	LT <sub>LED</sub>	LED Life Time (Typical)	30,000	-	-	[Hour]
Symbol	Description	Min.	Typ.	Max.	Unit	Remark																																																																																														
I <sub>F</sub>	LED String Current	-	110	115.5	[mA]	100% duty ratio of LED chip																																																																																														
V <sub>s</sub>	LED String Voltage	44.25	49.5	54	[Volt]	Isr=60mA @ 100% duty ratio, Note 4-1, Note 4-5																																																																																														
ΔV <sub>s</sub>	Maximum V <sub>s</sub> Voltage Deviation of single bar	-	-	3	[Volt]	Isr=60mA @ 100% duty ratio, Note 4-2																																																																																														
P <sub>LED</sub>	LED Light Bar Power Consumption	-	21.78	23.76	[Watt]	Note 4-3																																																																																														
LT <sub>LED</sub>	LED Life Time	30,000	-	-	[Hour]	Note 4-4																																																																																														
Symbol	Description	Min.	Typ.	Max.	Unit	Note																																																																																														
#LED1	LED Forward Current	-	110	115.5	[mA]	Note 1																																																																																														
#LED2	LED Forward Current	-	110	115.5	[mA]	Note 1																																																																																														
#LED3	LED Forward Current	-	110	115.5	[mA]	Note 1																																																																																														
#LED4	LED Forward Current	-	110	115.5	[mA]	Note 1																																																																																														
V <sub>BL</sub> LED	Light Bar Operation Voltage (for reference)	44.25	49.5	54	[Volt]	Note 2																																																																																														
P <sub>BLU</sub>	BLU Power Consumption (for reference)	-	21.78	23.76	[Watt]	Note 3																																																																																														
LT <sub>LED</sub>	LED Life Time (Typical)	30,000	-	-	[Hour]	Note 4																																																																																														
3.0 2014/8/5	all	Change chapter order																																																																																																		
	31		Remark width of bezel(upper and down)																																																																																																	
	19	<table border="1"> <thead> <tr> <th>Symbol</th> <th>Description</th> <th>Min.</th> <th>Typ.</th> <th>Max.</th> <th>Unit</th> <th>Note</th> </tr> </thead> <tbody> <tr> <td>IFLED1</td> <td>LED Forward Current</td> <td>-</td> <td>110</td> <td>115.5</td> <td>[mA]</td> <td>Note 1</td> </tr> </tbody> </table>	Symbol	Description	Min.	Typ.	Max.	Unit	Note	IFLED1	LED Forward Current	-	110	115.5	[mA]	Note 1	<table border="1"> <thead> <tr> <th>Symbol</th> <th>Description</th> <th>Min.</th> <th>Typ.</th> <th>Max.</th> <th>Unit</th> <th>Note</th> </tr> </thead> <tbody> <tr> <td>IFLED1</td> <td>LED Forward Current</td> <td>-</td> <td>110</td> <td>121</td> <td>[mA]</td> <td>Note 1</td> </tr> </tbody> </table>	Symbol	Description	Min.	Typ.	Max.	Unit	Note	IFLED1	LED Forward Current	-	110	121	[mA]	Note 1																																																																					
	Symbol	Description	Min.	Typ.	Max.	Unit	Note																																																																																													
	IFLED1	LED Forward Current	-	110	115.5	[mA]	Note 1																																																																																													
Symbol	Description	Min.	Typ.	Max.	Unit	Note																																																																																														
IFLED1	LED Forward Current	-	110	121	[mA]	Note 1																																																																																														
35	Pallet after Packing 8 boxes/pallet 1070(L)mm x 740(W)mm x 138(H)mm	Pallet after Packing 8 boxes/pallet 1070(L)mm x 740(W)mm x 108(H)mm																																																																																																		
7	White Luminance ( Center )=300nits <table border="1"> <tr> <td>Power Consumption (VDD line + LED line)</td> <td>[Watt]</td> <td>26.88 watt VDD line : PDD (typ), All white pattern at 60Hz = 5.1 W LED line : PBLU (typ) = 21.78 W@110mA</td> </tr> </table>	Power Consumption (VDD line + LED line)	[Watt]	26.88 watt VDD line : PDD (typ), All white pattern at 60Hz = 5.1 W LED line : PBLU (typ) = 21.78 W@110mA	White Luminance ( Center )350 cd/m2 (Typ.) @ 110mA 300 cd/m2 (Typ.) @ 100mA <table border="1"> <tr> <td>Power Consumption (VDD line + LED line)</td> <td>[Watt]</td> <td>26.88 watt@5.1W+21.78W=26.88W VDD line : PDD (typ), All white pattern at 60Hz = 5.1 W LED line : PBLU (typ) = 21.78 W@110mA</td> </tr> </table>	Power Consumption (VDD line + LED line)	[Watt]	26.88 watt@5.1W+21.78W=26.88W VDD line : PDD (typ), All white pattern at 60Hz = 5.1 W LED line : PBLU (typ) = 21.78 W@110mA																																																																																												
Power Consumption (VDD line + LED line)	[Watt]	26.88 watt VDD line : PDD (typ), All white pattern at 60Hz = 5.1 W LED line : PBLU (typ) = 21.78 W@110mA																																																																																																		
Power Consumption (VDD line + LED line)	[Watt]	26.88 watt@5.1W+21.78W=26.88W VDD line : PDD (typ), All white pattern at 60Hz = 5.1 W LED line : PBLU (typ) = 21.78 W@110mA																																																																																																		
4.0 2016/12/23	all	Change to new format																																																																																																		
	7	2.1 Display Characteristics 350cd/m2@110mA / 300cd/m2@100mA	2.1 Display Characteristics 350 cd/m2 (Typ.)																																																																																																	
	8		2.3 Optical Characteristics																																																																																																	
	13		4.2 Backlight Unit LED Pulse Current: 210→300mA																																																																																																	
	15		5.1.1 Power Specification PDD1: 7.26W→7.3W																																																																																																	
	19	5.2 Backlight Unit Each module consists of 40 pcs LED ( 4 strings x 10pcs / string )	5.2 Backlight Unit LED Forward Current: 110mA→90mA PBLU: 21.78W→16.7W Each module consists of 60 pcs LED ( 4 strings x 15pcs / string )																																																																																																	
	25		6.6 Power ON/OFF Sequence																																																																																																	
26		7.1 TFT LCD Module																																																																																																		

## 1 Handling Precautions

- 1) Since front polarizer is easily damaged, pay attention not to scratch it.
- 2) Be sure to turn off power supply when inserting or disconnecting from input connector.
- 3) Wipe off water drop immediately. Long contact with water may cause discoloration or spots.
- 4) When the panel surface is soiled, wipe it with absorbent cotton or other soft cloth.
- 5) Since the panel is made of glass, it may break or crack if dropped or bumped on hard surface.
- 6) Since CMOS LSI is used in this module, take care of static electricity and insure human earth when handling.
- 7) Do not open or modify the Module Assembly.
- 8) Do not press the reflector sheet at the back of the module to any directions.
- 9) In case if a Module has to be put back into the packing container slot after once it was taken out from the container, do not press the center of LED light bar edge. Instead, press at the far ends of the LED light bar edge softly. Otherwise the TFT Module may be damaged.
- 10) At the insertion or removal of the Signal Interface Connector, be sure not to rotate nor tilt the Interface Connector of the TFT Module.
- 11) After installation of the TFT Module into an enclosure, do not twist nor bend the TFT Module even momentary. At designing the enclosure, it should be taken into consideration that no bending/twisting forces are applied to the TFT Module from outside. Otherwise the TFT Module may be damaged.
- 12) Small amount of materials having no flammability grade is used in the LCD module. The LCD module should be supplied by power complied with requirements of Limited Power Source (IEC60950 or UL1950), or be applied exemption.
- 13) Avoid touching COF position while doing mechanical design.
- 14) While storing modules as spares for a long time, the following precautions are necessary:
  - Store modules in a dark place. Do not expose them to sunlight or fluorescent light.
  - Keep the temperature between 5°C and 35°C at normal humidity.

## 2 General Description

This specification applies to the 27 inch-FHD color a-Si TFT-LCD Module P270HVN01.0. The display supports the FHD - 1920(H) x 1080(V) screen format and 16.7M colors (RGB 8-bit data). The light source of this TFT-LCD module is W-LED. All input signals are 2-channel LVDS interface and this module doesn't contain a driver for backlight.

### 2.1 Display Characteristics

The following items are characteristics summary on the table under 25°C condition:

Items	Unit	Specification
Screen Diagonal	[mm]	685.65(27.0")
Active Area	[mm]	597.6 (H) x 336.15 (V)
Pixels H x V		1920(x3) x 1080
Pixel Pitch	[um]	311.25 (per one triad) x311.25
Pixel Arrangement		R.G.B. Vertical island
Display Mode		VA Mode, Normally Black
White Luminance ( Center )	[cd/m <sup>2</sup> ]	350 cd/m <sup>2</sup> (Typ.)
Contrast Ratio		3000 (Typ.)
Optical Response Time	[msec]	12ms (Typ., on/off)
Nominal Input Voltage	[Volt]	5 V (Typ)
Power Consumption (VDD line + LED line)	[Watt]	21.39 watt(4.65W+16.74W=21.39W) VDD line : PDD (typ),All white pattern at 60Hz = 4.65 W LED line : PBLU (typ) = 16.74 W(@90mA)
Weight	[g]	2180 gram (Typ.)
Physical Size	[mm]	613.6(H)x356.85(V)x10.0(D) (Typ.)
Electrical Interface		Dual channel LVDS
Support Color		16.7M colors (RGB 8-bit)
Surface Treatment		Anti-Glare 3H
Temperature Range		
Operating	[°C]	0 to +50
Storage (Shipping)	[°C]	-20 to +60
RoHS Compliance		RoHS Compliance
TCO Compliance		TCO 6.0 Compliance

## 2.2 Optical Characteristics

The optical characteristics are measured under stable conditions at 25°C:

Item	Unit	Conditions	Min.	Typ.	Max.	Note
Viewing Angle	[degree]	Horizontal (Right) CR = 10 (Left)	150	178	-	2
		Vertical (Up) CR = 10 (Down)	150	178	-	
Contrast ratio		Normal Direction	1800	3000	-	3
Response Time	[msec]	Raising Time (T <sub>IR</sub> )	-	7	17	4
		Falling Time (T <sub>IF</sub> )	-	5	7	
		Raising + Falling	-	12	24	
Color / Chromaticity Coordinates (CIE)		Red x	0.610	0.640	0.670	5
		Red y	0.303	0.333	0.363	
		Green x	0.290	0.320	0.350	
		Green y	0.590	0.620	0.650	
		Blue x	0.126	0.156	0.186	
		Blue y	0.025	0.055	0.085	
Color Coordinates (CIE) White		White x	0.283	0.313	0.343	
		White y	0.299	0.329	0.359	
Central Luminance	[cd/m <sup>2</sup> ]		280	350	-	6
Luminance Uniformity	[%]		75	80	-	7
Crosstalk (in 60Hz)	[%]				1.5	8
Flicker	dB				-20	9



**Note 1: Measurement Method**

The LCD module should be stabilized at given temperature for 30 minutes to avoid abrupt temperature change during measuring (at surface 35°C). In order to stabilize the luminance, the measurement should be executed after lighting Backlight for 30 minutes in a stable, windless and dark room.

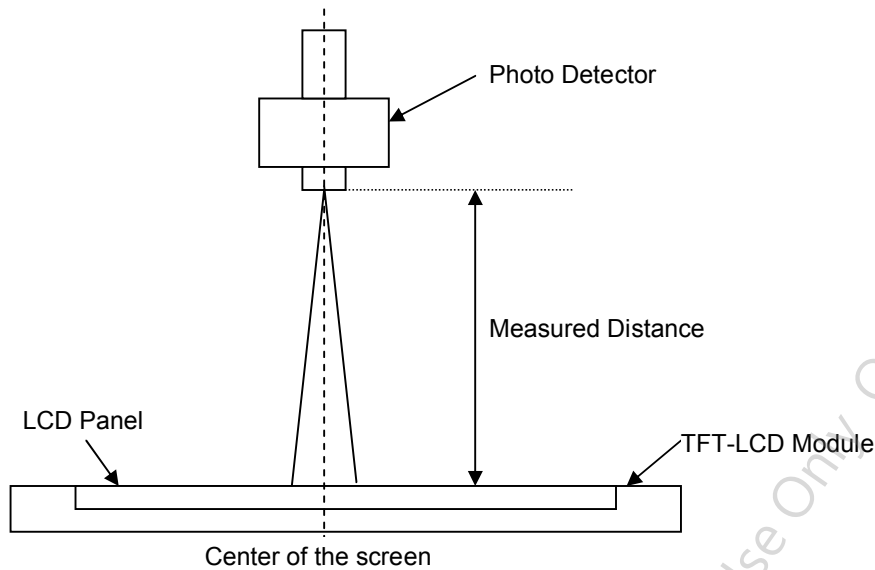

**Note 2: Definition of Viewing Angle measured by ELDIM (EZContrast 88)**

Viewing angle is the measurement of contrast ratio  $\geq 10$ , at the screen center, over a 180° horizontal and 180° vertical range (off-normal viewing angles). The 180° viewing angle range is broken down as follows; 90° ( $\theta$ ) horizontal left and right and 90° ( $\Phi$ ) vertical, high (up) and low (down). The measurement direction is typically perpendicular to the display surface with the screen rotated about its center to develop the desired measurement viewing angle.

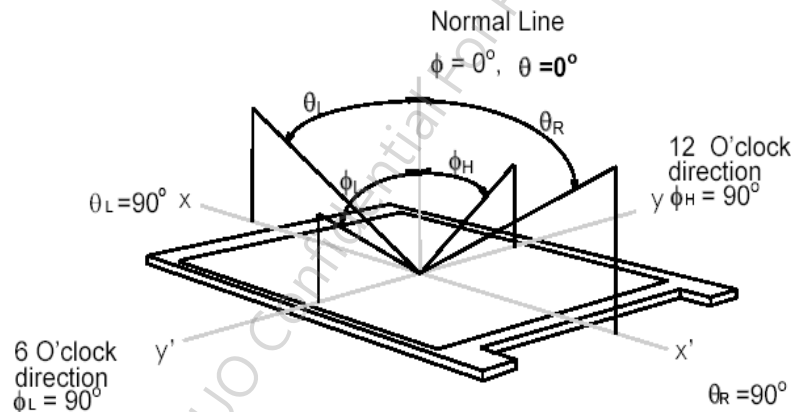

*Note 3:* Contrast Ratio measured by TOPCON SR-3

*Note 4:* Definition of Response time measured by Westar TRD-100A

The output signals of photo detector are measured when the input signals are changed from “Full Black” to “Full White” (rising time,  $T_{rR}$ ), and from “Full White” to “Full Black” (falling time,  $T_{rF}$ ), respectively. The response time is interval between the 10% and 90% (1 frame at 60 Hz) of amplitudes.

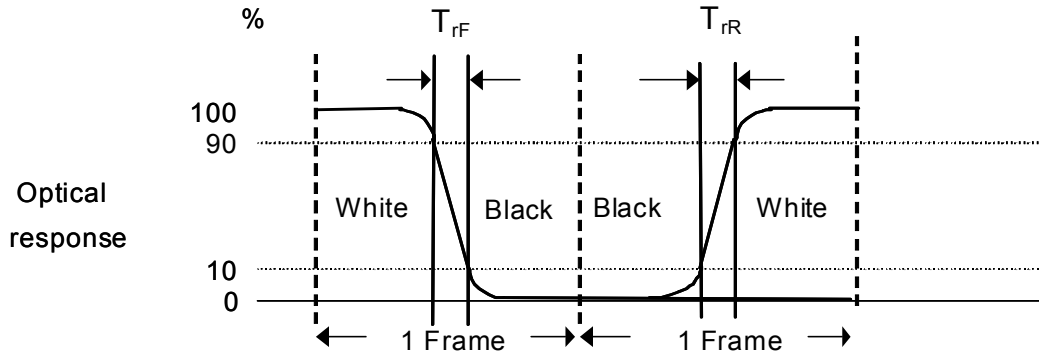

$T_{rR} + T_{rF} = 12 \text{ msec (typ.)}$ .

*Note 5:* Color Chromaticity and Coordinates (CIE) measured by TOPCON SR-3

*Note 6:* Central Luminance measured by TOPCON SR-3

*Note 7:* Luminance Uniformity of these 9 points defined as below and measured by TOPCON SR-3

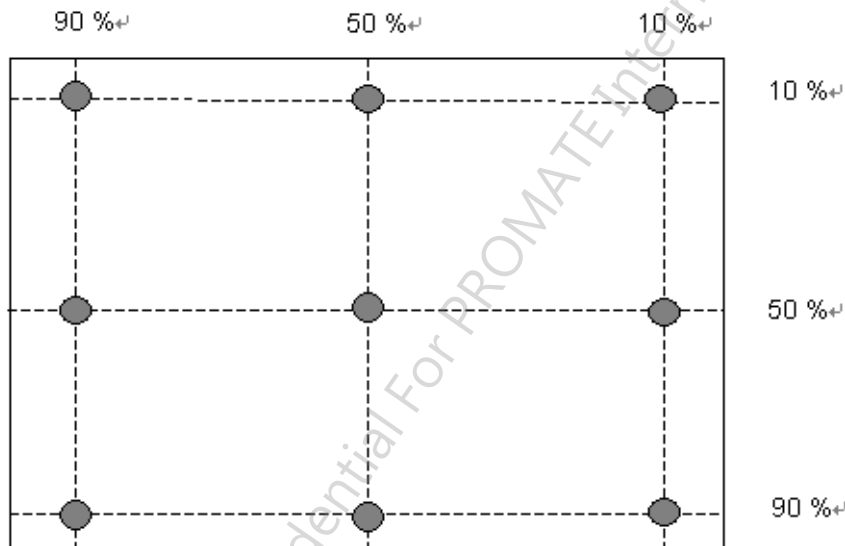

$$\text{Uniformity} = \frac{\text{Minimum Luminance in 9 points (1-9)}}{\text{Maximum Luminance in 9 Points (1-9)}}$$

*Note 8:* Crosstalk defined as below and measured by TOPCON SR-3

$$CT = | YB - YA | / YA \times 100 (\%)$$

Where

YA = Luminance of measured location without gray level 0 pattern (cd/m<sup>2</sup>)

YB = Luminance of measured location with gray level 0 pattern (cd/m<sup>2</sup>)

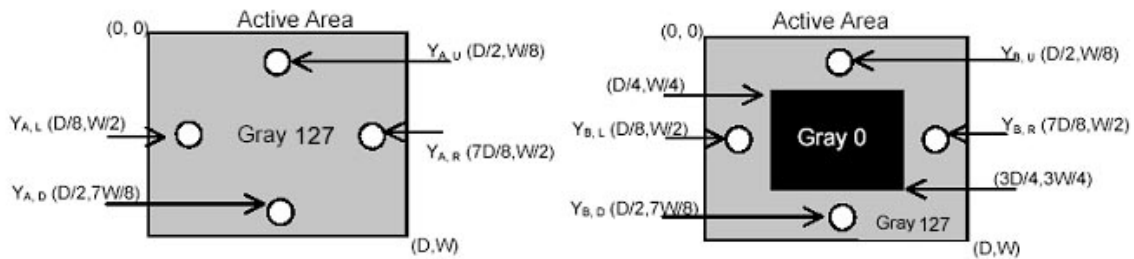

Note 9: Test Pattern Sub-checker Pattern measured by TOPCON SR-3

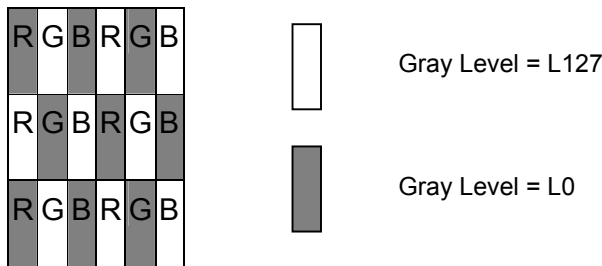

Method: Record dBV & DC value with TRD-100

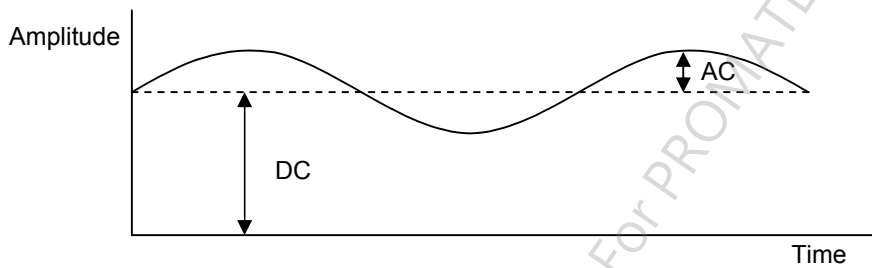

$$\text{Flicker (dB)} = 20 \log \frac{\text{AC Level (at 30 Hz)}}{\text{DC Level}}$$

## 3 Functional Block Diagram

The following diagram shows the functional block of the 27.0 inch Color TFT-LCD Module:

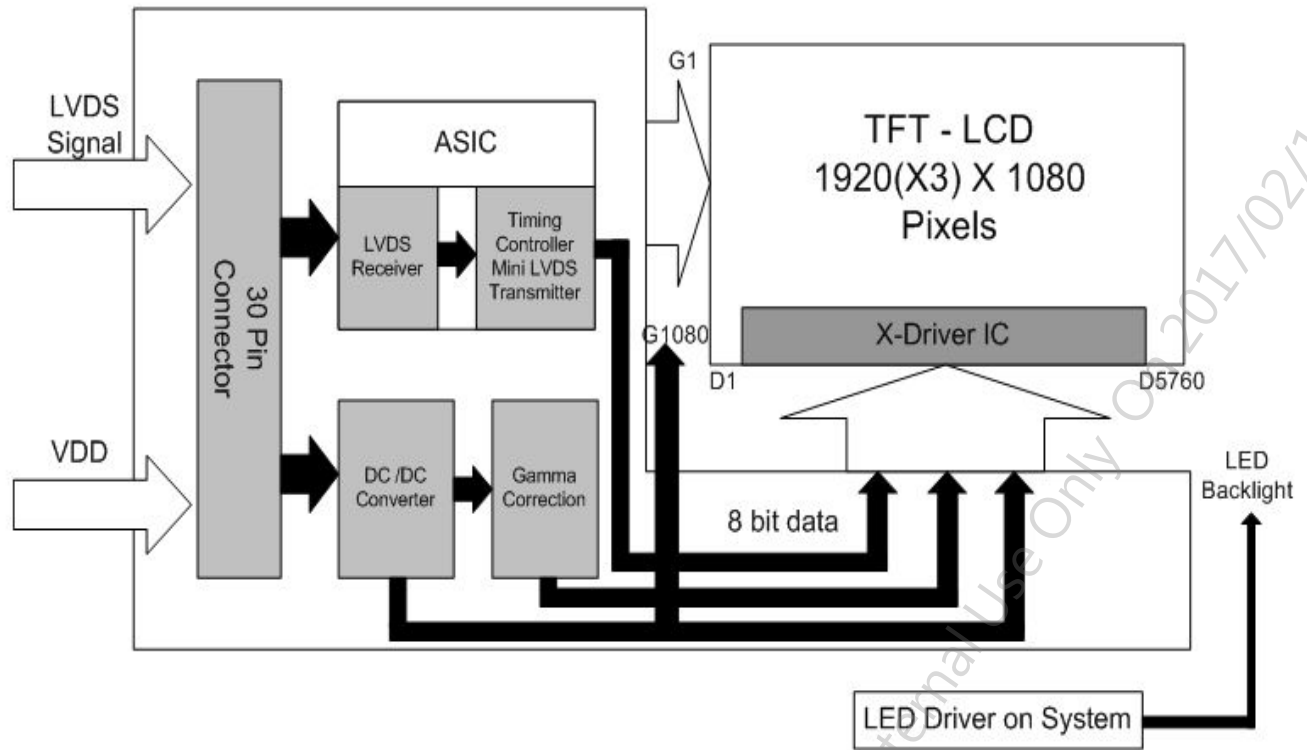

## 4 Absolute Maximum Ratings

Absolute maximum ratings of the module are listed as follows:

### 4.1 TFT LCD Module

Item	Symbol	Min	Max	Unit	Conditions
Logic/LCD Drive	VDD	-0.3	6.0	[Volt]	Note 1, 2

### 4.2 Backlight Unit

Item	Symbol	Min	Max	Unit	Conditions
LED Forward Current	IFLED1	0	150	[mA]	Note 1,2,5 100% duty
	IFLED2				
	IFLED3				
	IFLED4				
LED Pulse Forward Current	IPLED1	-	300	[mA]	Note 1,2,5 10% duty @100Hz
	IPLED2				
	IPLED3				
	IPLED4				
LED forward Voltage variation (per string variation)	$\Delta V_f$	-	3	[Volt]	Note 1, 2

### 4.3 Absolute Ratings of Environment

Item	Symbol	Min.	Max.	Unit	Conditions
Operating Temperature	TOP	0	+50	[°C]	Note 3
Glass Surface Temperature (Operation)	TGS	0	+65	[°C]	Note3 Note4
Operation Humidity	HOP	5	90	[%RH]	Note 3
Storage Temperature	TST	-20	+60	[°C]	
Storage Humidity	HST	5	90	[%RH]	

Note 1: With in Ta (25 °C)

Note 2: Permanent damage to the device may occur if exceeding maximum values

Note 3: Temperature and relative humidity range are shown as the below figure.

1. 90% RH Max ( Ta ≤ 39°C)
2. Max wet-bulb temperature at 39°C or less. ( Ta ≤ 39°C)
3. No condensation

Note 4: Function Judged only

Note 5: IFLED1,2,3,4 and IPLED1,2,3,4 define as per strings LED current.

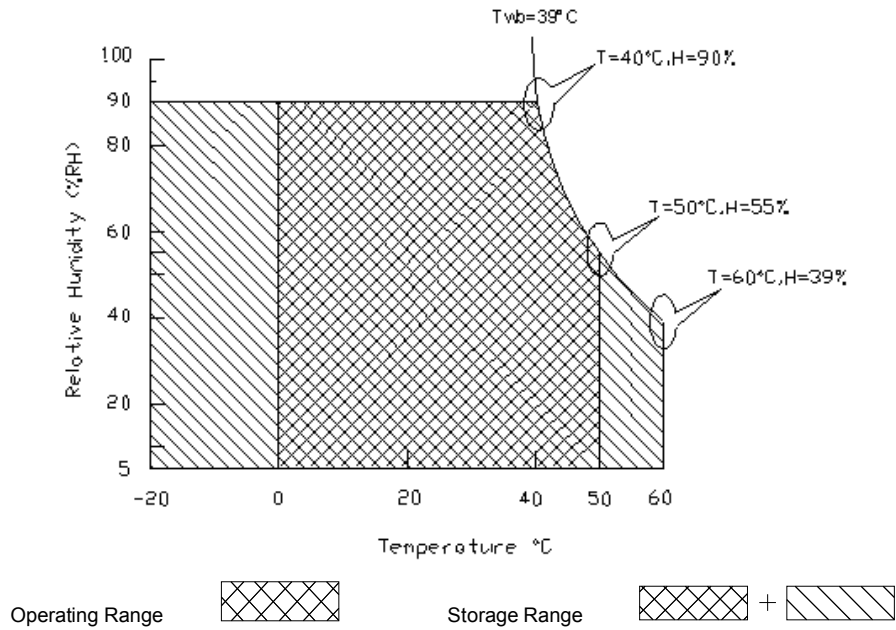

AUO Confidential For PROMATE Internal Use Only On 2017/02/13

## 5 Electrical Characteristics

### 5.1 TFT LCD Module

#### 5.1.1 Power Specification

Input power specifications are listed as follows:

Symbol	Description	Min	Typ.	Max	Unit	Conditions
VDD	Logic/LCD Drive Voltage	4.5	5.0	5.5	[Volt]	+/-10%
IDD1	Input Current	-	0.93	1.22	[A]	VDD= 5.0V, All white Pattern at 60 Hz
		-	1.22	1.46	[A]	VDD= 5.0V, All white Pattern at 75 Hz
PDD1	VDD Power	-	4.65	6.10	[Watt]	VDD= 5.0V, All white Pattern at 60 Hz
		-	6.10	7.30	[Watt]	VDD= 5.0V, All white Pattern at 75 Hz
IRush	Inrush Current	-	-	3	[A]	<b>Note 1</b>
VDDrp	Allowable Logic/LCD Drive Ripple Voltage	-	-	500	[mV] p-p	VDD= 5.0V, All white Pattern at 75 Hz

**Note 1:** Measurement Conditions:

The duration of rising time of power input is 470 us.

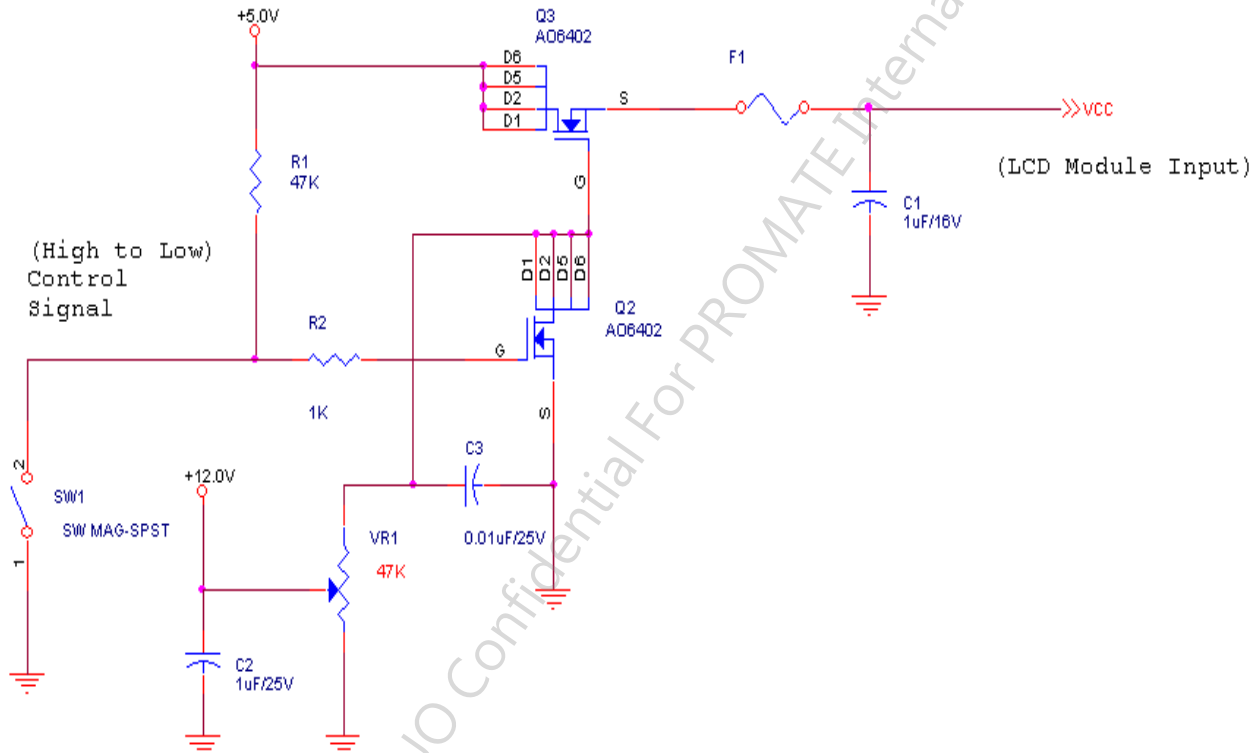

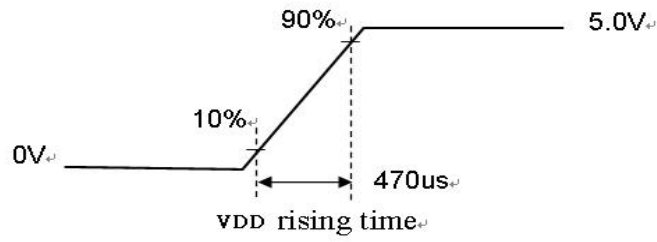

AUO Confidential For PROMATE Internal Use Only On 2017/02/13



## 5.1.2 Signal Electrical Characteristics

(1) DC Characteristics of each signal are as following:

Symbol	Description	Min	Typ	Max	Units	Conditions
$V_{TH}$	Differential Input High Threshold	-	-	+100	[mV]	$V_{CM} = 1.2V$ Note 1
$V_{TL}$	Differential Input Low Threshold	-100	-	-	[mV]	$V_{CM} = 1.2V$ Note 1
$ V_{ID} $	Input Differential Voltage	100	-	600	[mV]	Note 1
$V_{CM}$	Differential Input Common Mode Voltage	+1.0	+1.2	+1.5	[V]	$V_{TH}-V_{TL} = 200MV$ (max) Note 1

Note 1: LVDS Signal Waveform

### Single-End

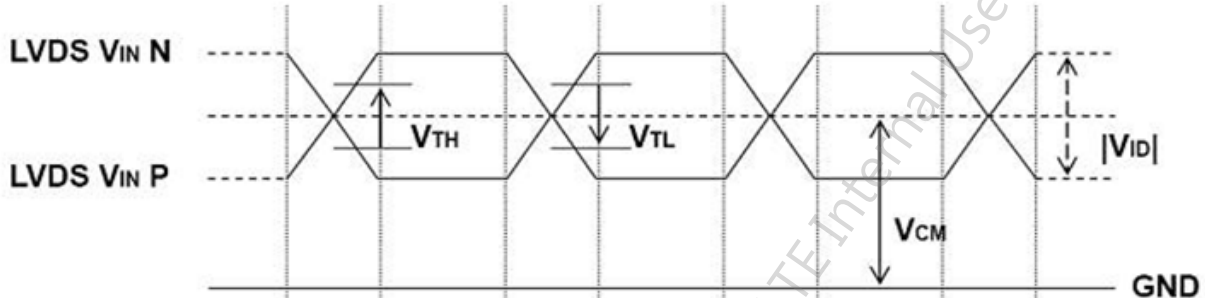

### Differential Signal

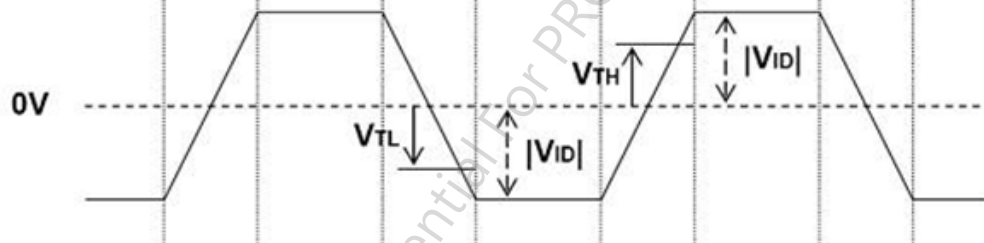

## (2) AC Characteristics

Symbol	Description	Min	Max	Units	Conditions
$F_{DEV}$	Maximum deviation of input clock frequency during SSC	-	$\pm 3$	%	
$F_{MOD}$	Maximum modulation frequency of input clock during SSC	-	200	KHz	

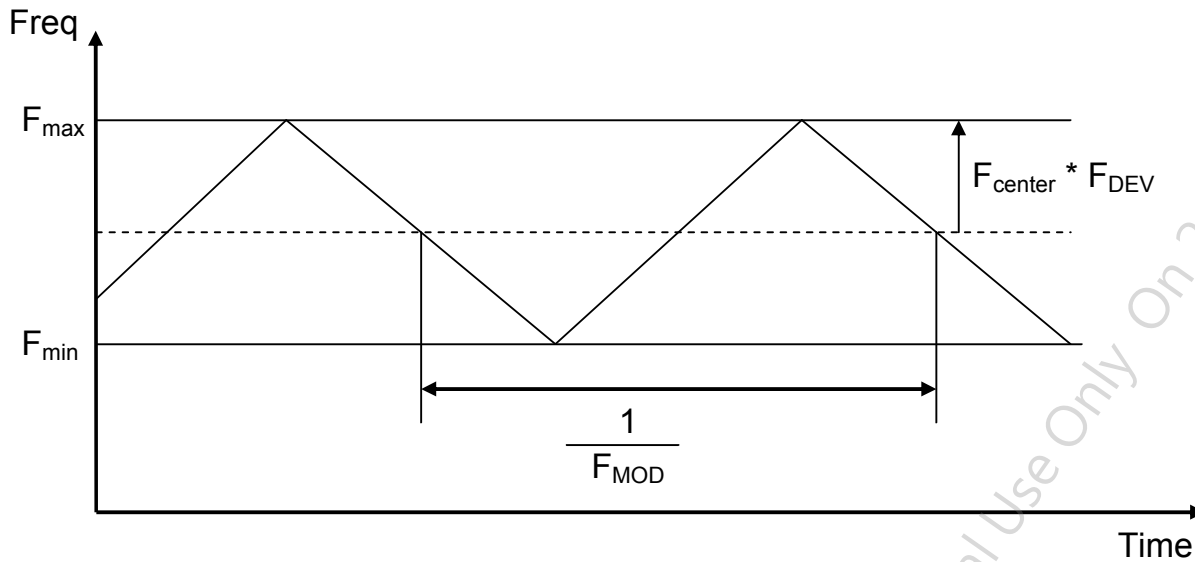

< Spread Spectrum >

## 5.2 Backlight Unit

Parameter guideline for LED driving is under stable conditions at 25 °C (Room Temperature):

Symbol	Description	Min.	Typ.	Max.	Unit	Note
IFLED1	LED Forward Current	-	90	99	[mA]	Note 1
IFLED2						
IFLED3						
IFLED4						
VSLED	Light Bar Operation Voltage (for reference)	42	46.5	51	[Volt]	Note 2
PBLU	BLU Power Consumption (for reference)	-	16.7	18.4	[Watt]	Note 3
LTLED	LED Life Time (Typical)	30,000	-	-	[Hour]	Note 4

Each module consists of 60 pcs LED ( 4 strings x 15pcs / string )

*Note 1:* The specified current is 100% duty of LED chip input current, IRLED1,2,3,4 define as per strings LED current.

*Note 2:* The value showed is one string operation voltage.

*Note 3:*  $PBLU = VSLED * (IFLED1 + IFLED2 + IFLED3 + IFLED4)$

*Note 4:* Definition of life time: Brightness becomes to 50% of its original value. The minimum life time of LED unit is on the condition of IFLED = 90mA and 25±2°C (Room Temperature).

*Note 5:* Recommendation for LED driver power design:

Due to there are electrical property deviation in LED & monitor set system component after long time operation. AUO strongly recommend the design value of LED driver board OVP (over voltage protection) should be 10% higher than max. value of LED string voltage (Vs) at least.

## 6 Signal Characteristics

### 6.1 Pixel Format Definition

Following figure shows the relationship between the input signals and LCD pixel format.

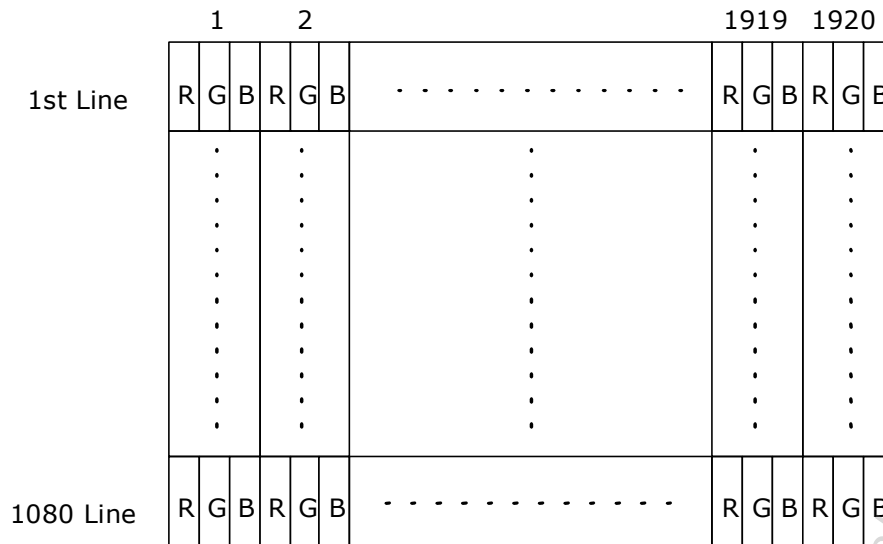

### 6.2 Input Data Format Definition

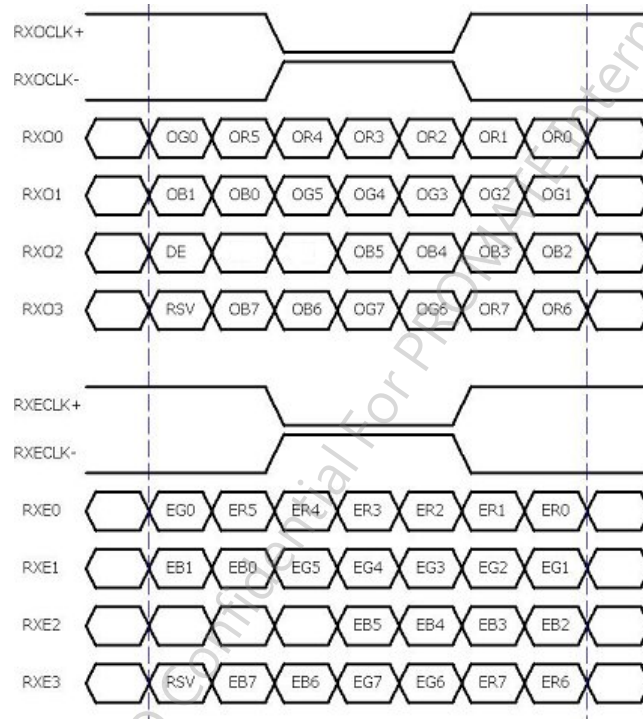

Note1: Normally, DE, VS, HS on EVEN channel are not used.

Note2: Please follow PSWG.

Note3: 8-bit in

## 6.3 Signal Description

PIN #	SIGNAL NAME	DESCRIPTION
1	RX00-	Negative LVDS differential data input (Odd data)
2	RX00+	Positive LVDS differential data input (Odd data)
3	RX01-	Negative LVDS differential data input (Odd data)
4	RX01+	Positive LVDS differential data input (Odd data)
5	RX02-	Negative LVDS differential data input (Odd data)
6	RX02+	Positive LVDS differential data input (Odd data)
7	GND	Power Ground
8	RXOCLK-	Negative LVDS differential clock input (Odd clock)
9	RXOCLK+	Positive LVDS differential clock input (Odd clock)
10	RX03-	Negative LVDS differential data input (Odd data)
11	RX03+	Positive LVDS differential data input (Odd data)
12	RXE0-	Negative LVDS differential data input (Even data)
13	RXE0+	Positive LVDS differential data input (Even data)
14	GND	Power Ground
15	RXE1-	Negative LVDS differential data input (Even data)
16	RXE1+	Positive LVDS differential data input (Even data)
17	GND	Power Ground
18	RXE2-	Negative LVDS differential data input (Even data)
19	RXE2+	Positive LVDS differential data input (Even data)
20	RXECLK-	Negative LVDS differential clock input (Even clock)
21	RXECLK+	Positive LVDS differential clock input (Even clock)
22	RXE3-	Negative LVDS differential data input (Even data)
23	RXE3+	Positive LVDS differential data input (Even data)
24	GND	Power Ground
25	NC	No contact
26	NC	No contact
27	NC	No contact
28	VDD	+5.0V Power Supply
29	VDD	+5.0V Power Supply
30	VDD	+5.0V Power Supply

Note 1: Input signals of odd and even clock shall be the same timing.

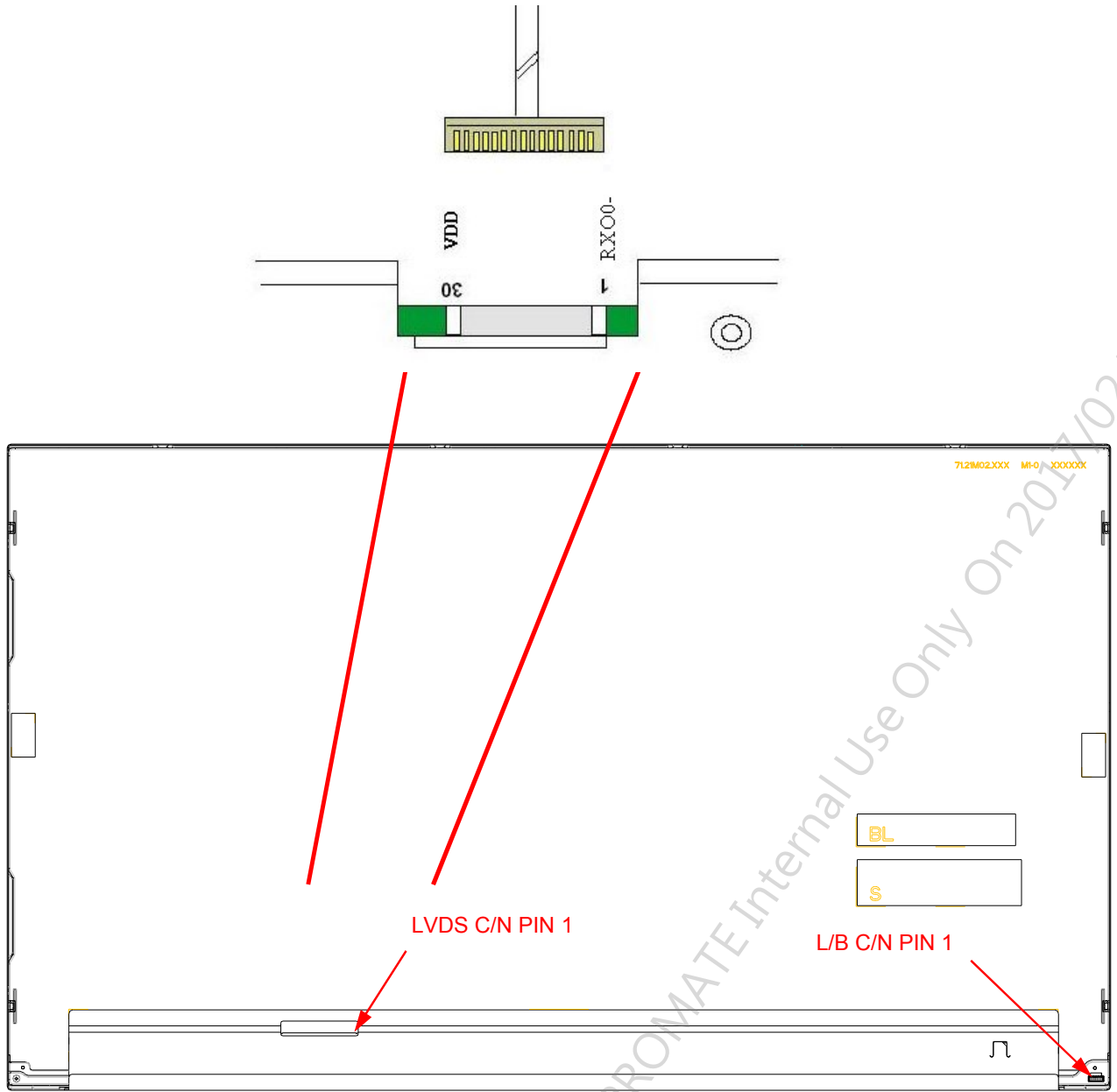

AUO Confidential For PROMATE Internal Use Only On 2017/02/13

## 6.4 Timing Characteristics

It only support DE mode, and the input timing are shown as the following table.

Symbol	Description		Min.	Typ.	Max.	Unit	Remark
Tv	Vertical Section	Period	1092	1130	1793	Th	
Tdisp (v)		Active	1080	1080	1080	Th	
Tblk (v)		Blanking	12	50	713	Th	
Fv		Frequency	50	60	76	Hz	
Th	Horizontal Section	Period	1004	1050	1100	Tclk	
Tdisp (h)		Active	960	960	960	Tclk	
Tblk (h)		Blanking	44	90	140	Tclk	
Fh		Frequency	55	68	90	KHz	<b>Note 1</b>
Tclk	LVDS Clock	Period	11.1	14.0	18.2	ns	1/Fclk
Fclk		Frequency	54.8	71.2	90.0	MHz	<b>Note 2</b>

**Note 1:** The equation is listed as following. Please don't exceed the above recommended value.

$$Fh \text{ (Min.)} = Fclk \text{ (Min.)} / Th \text{ (Min.)};$$

$$Fh \text{ (Typ.)} = Fclk \text{ (Typ.)} / Th \text{ (Typ.)};$$

$$Fh \text{ (Max.)} = Fclk \text{ (Max.)} / Th \text{ (Min.)};$$

**Note 2:** The equation is listed as following. Please don't exceed the above recommended value.

$$Fclk \text{ (Min.)} = Fv \text{ (Min.)} \times Th \text{ (Min.)} \times Tv \text{ (Min.)};$$

$$Fclk \text{ (Typ.)} = Fv \text{ (Typ.)} \times Th \text{ (Typ.)} \times Tv \text{ (Typ.)};$$

$$Fclk \text{ (Max.)} = Fv \text{ (Max.)} \times Th \text{ (Typ.)} \times Tv \text{ (Typ.)};$$

## Timing Diagram

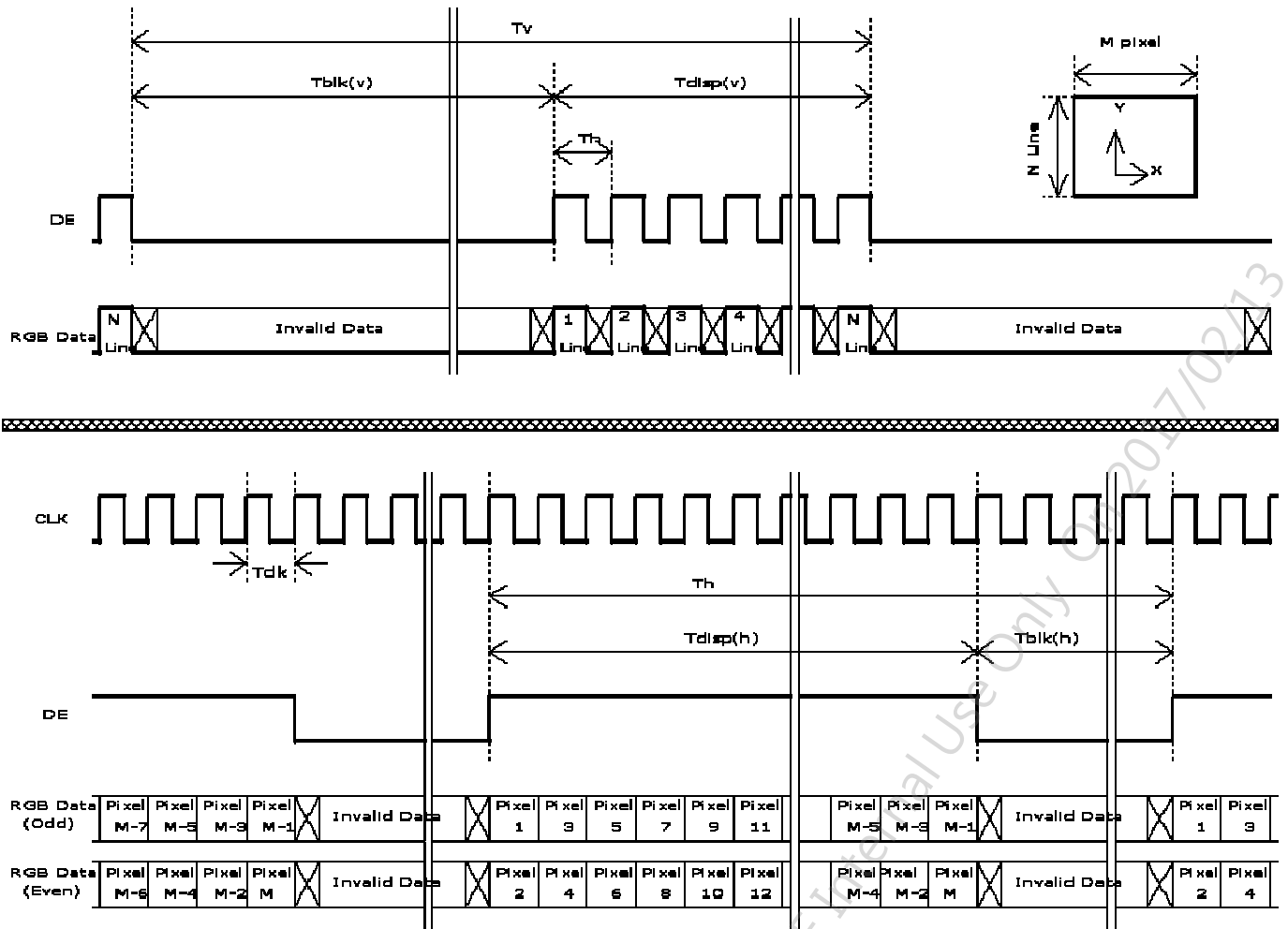



## 6.5 Power ON/OFF Sequence

VDD power and lamp on/off sequence are as follows. Interface signals are also shown in the chart. Signals from any system shall be Hi-Z state when VDD is off.

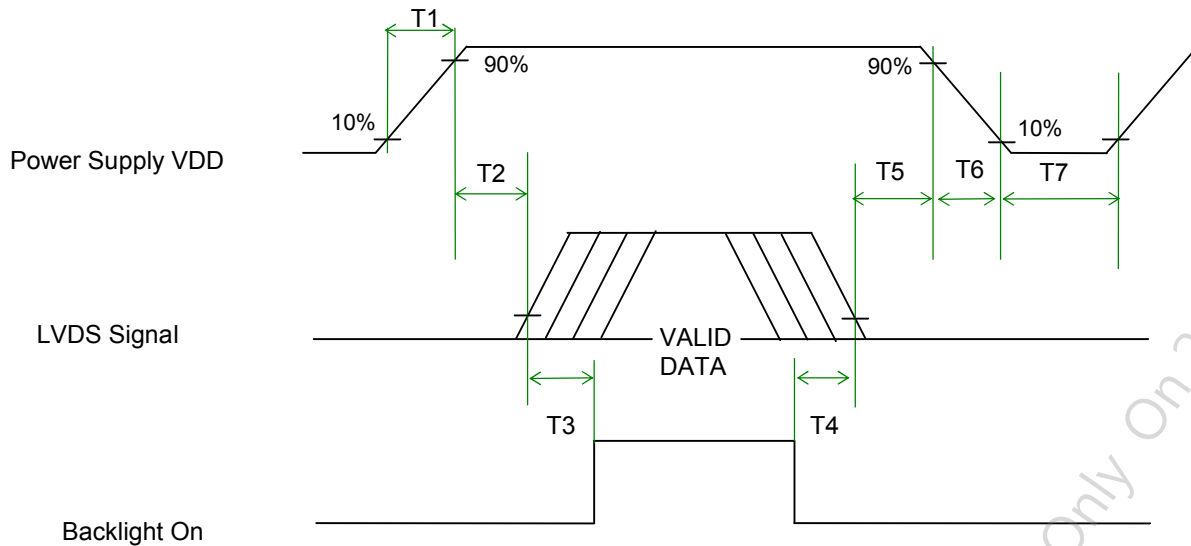

Power Sequence Timing

Parameter	Value			Unit
	Min.	Typ.	Max.	
T1	0.5	-	10	[ms]
T2	0	-	50	[ms]
T3	500	-	-	[ms]
T4	100	-	-	[ms]
T5	0	-	50	[ms] <i>Note 1,2</i>
T6	0	-	200	[ms] <i>Note 2,3</i>
T7	1000	-	-	[ms]

*Note1* : Recommend setting T5 = 0ms to avoid electronic noise when VDD is off.

*Note2* : During T5 and T6 period , please keep the level of input LVDS signals with Hi-Z state.

*Note3*: Voltage of VDD must decay smoothly after power-off. (customer system decide this value)

## 7 Connector and Pin Assignment

Physical interface is described as for the connector on module. These connectors are capable of accommodating the following signals and will be following components.

### 7.1 TFT LCD Module

Connector Name / Designation	Interface Connector / Interface Card
Manufacturer	STM P-TWO <a href="#">STARCONN</a>
Type Part Number	MSCKT2407P30HB AL230F-A0G1D-P <a href="#">093G30-02001A-M4</a>
Mating Housing Part Number	FI-X30HL (Locked Type)

#### 7.1.1 Pin Assignment

Pin#	Signal Name	Pin#	Signal Name
1	RX00-	2	RX00+
3	RX01-	4	RX01+
5	RX02-	6	RX02+
7	GND	8	RXOCLK-
9	RXOCLK+	10	RX03-
11	RX03+	12	RXE0-
13	RXE0+	14	GND
15	RXE1-	16	RXE1+
17	GND	18	RXE2-
19	RXE2+	20	RXECLK-
21	RXECLK+	22	RXE3-
23	RXE3+	24	GND
25	NC	26	NC
27	NC	28	VDD
29	VDD	30	VDD

## 7.2 LED Connector on Backlight Unit

This connector is mounted on LED light bar.

Connector Name / Designation	Light Bar Connector
Manufacturer	E&T(ENTERY)
Type Part Number	3707K-S06N-21R
Mating Housing Part Number	H112K-P06N-13B (Locked Type)

### 7.2.1 LED Pin assignment

Pin#	Signal Name
1	IFLED (current return)
2	IFLED (current return)
3	VSLED (voltage in)
4	VSLED (voltage in)
5	IFLED (current return)
6	IFLED (current return)

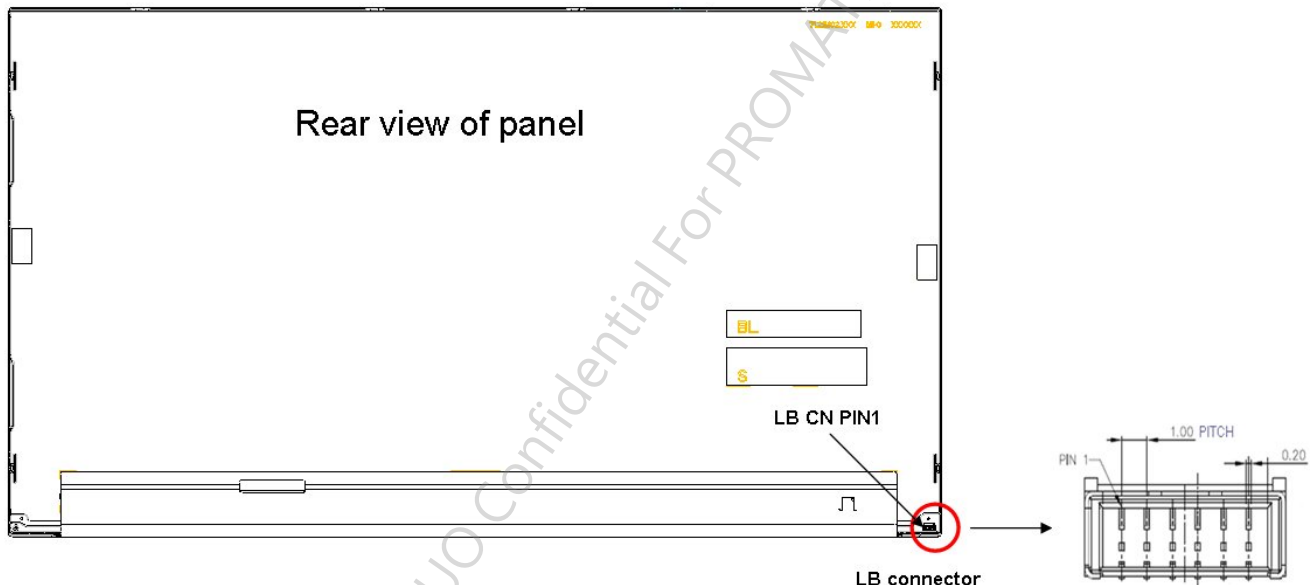

## 7.2.2 LED Connector Dimension

$H \times V \times D = 13.9 \times 3.00 \times 4.25$ , Pitch = 1.0 (unit = mm)

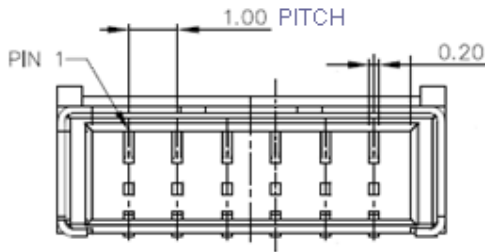
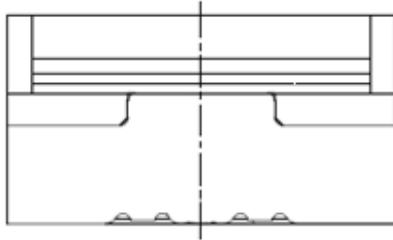

## 7.2.3 LED Mating housing dimension

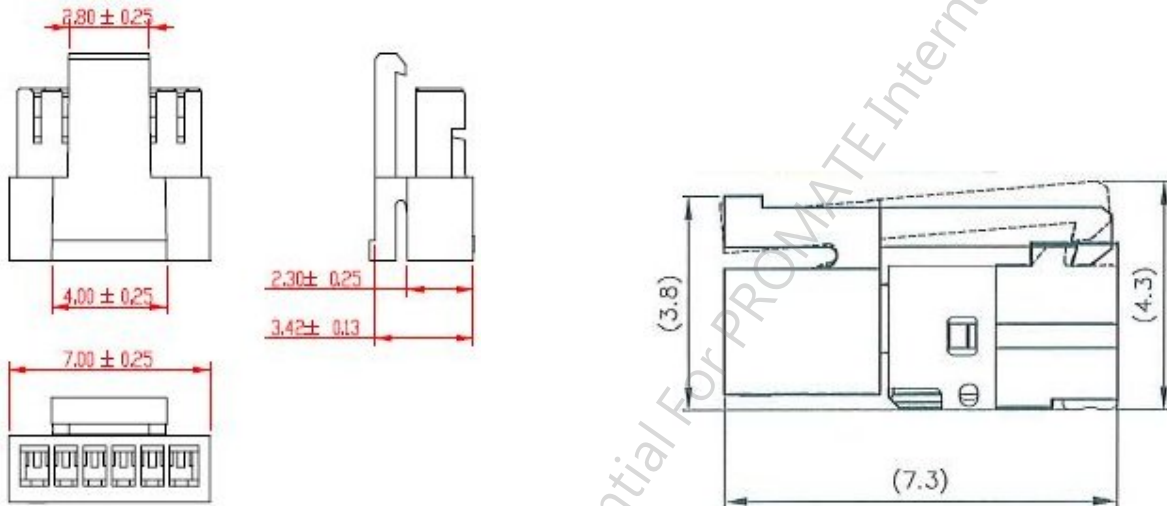

## 8 Reliability Test

Environment test conditions are listed as following table.

Items	Required Condition	Note
Temperature Humidity Bias (THB)	Ta= 50°C, 80%RH, 300 hours	
High Temperature Operation (HTO)	Ta= 50°C, 50%RH, 300 hours	
Low Temperature Operation (LTO)	Ta= 0°C, 300 hours	
High Temperature Storage (HTS)	Ta= 60°C, 300 hours	
Low Temperature Storage (LTS)	Ta= -20°C, 300 hours	
Vibration Test (Non-operation)	Acceleration: 1.5 Grms Wave: Random Frequency: 10 - 200 Hz Duration: 30 Minutes each Axis (X, Y, Z)	
Shock Test (Non-operation)	Acceleration: 50 G Wave: Half-sine Active Time: 20 ms Direction: ±X, ±Y, ±Z (one time for each Axis)	
Drop Test	Height: 46 cm, package test	
Thermal Shock Test (TST)	-20°C/30min, 60°C/30min, 100 cycles	Note 1
On/Off Test	On/10sec, Off/10sec, 30,000 cycles	
ESD (Electro Static Discharge)	Contact Discharge: ± 15KV, 150pF(330Ω ) 1sec, 15 points, 25 times/ point	Note 2
	Air Discharge: ± 15KV, 150pF(330Ω ) 1sec 15 points, 25 times/ point	
Altitude Test	Operation: 18,000 ft Non-Operation: 40,000 ft	Note 3

**Note 1:** The TFT-LCD module will not sustain damage after being subjected to 100 cycles of rapid temperature change. A cycle of rapid temperature change consists of varying the temperature from -20°C to 60°C, and back again. Power is not applied during the test. After temperature cycling, the unit is placed in normal room ambient for at least 4 hours before power on.

**Note 2:** EN61000-4-2, ESD class B: Certain performance degradation allowed:

- No data lost
- Self-recoverable
- No hardware failures

**Note 3: Result Evaluation Criteria:**

TFT-LCD panels test should take place after gradually cooling enough at room temperature. In the normal application, there should be o particular problems that may affect the display function.

## 9 Shipping Label

The label on the panel is shown as below:

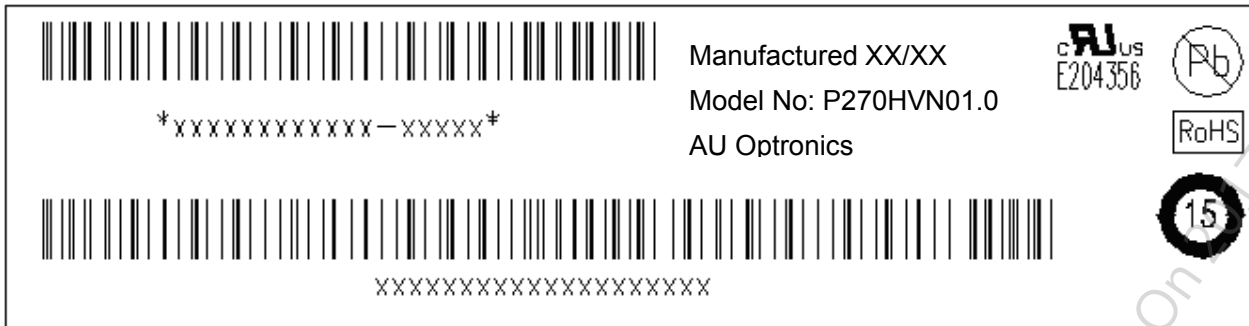

**Note 1:** For Pb Free products, AUO will add  for identification.

**Note 2:** For RoHS compatible products, AUO will add  for identification.

**Note 3:** For China RoHS compatible products, AUO will add  for identification.

**Note 4:** The Green Mark will be presented only when the green documents have been ready by AUO Internal Green Team.



# Product Specification

P270HVN01.0

AU OPTRONICS CORPORATION

## 10 Mechanical Characteristics

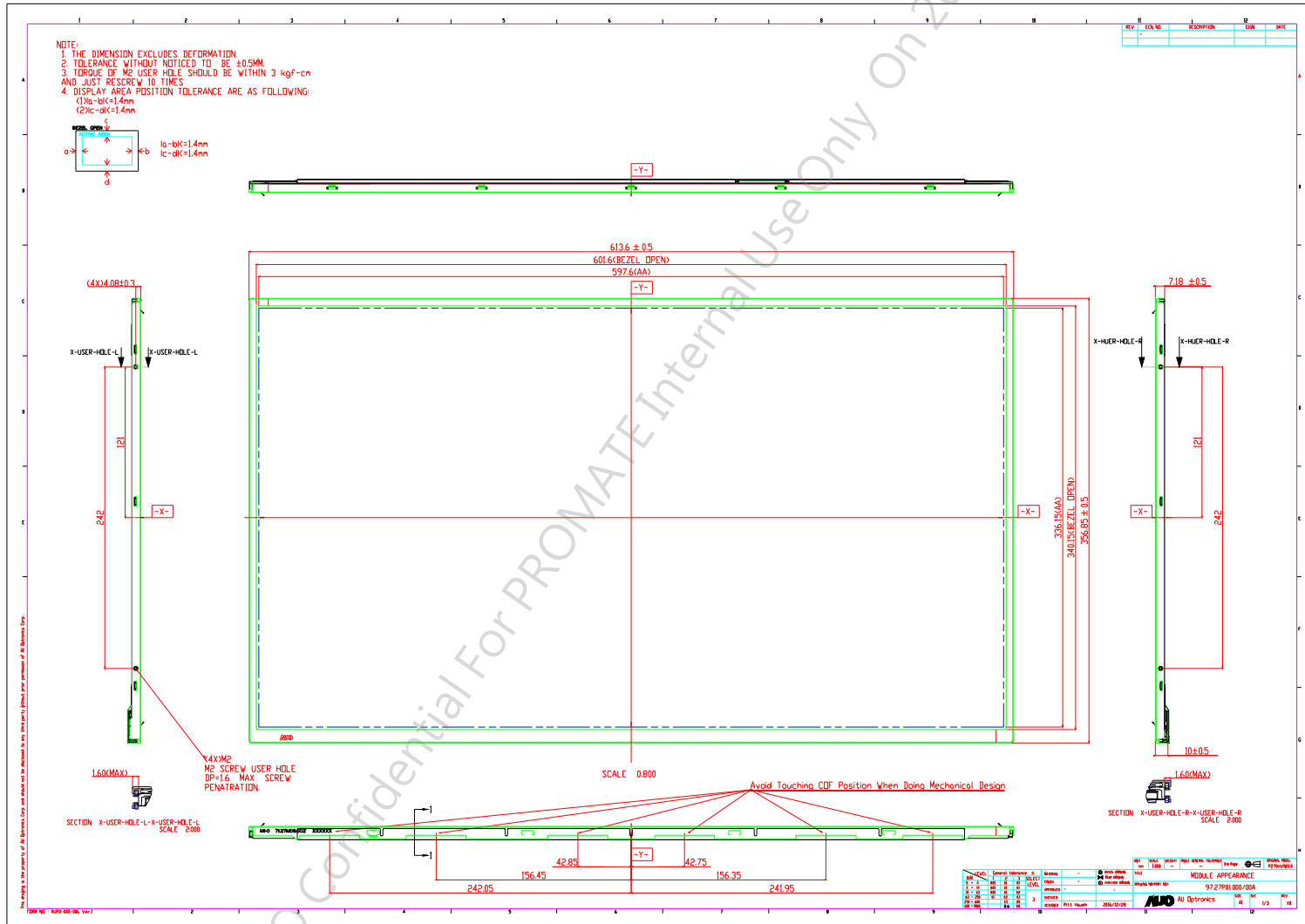

Front View



# Product Specification

P270HVN01.0

AU OPTRONICS CORPORATION

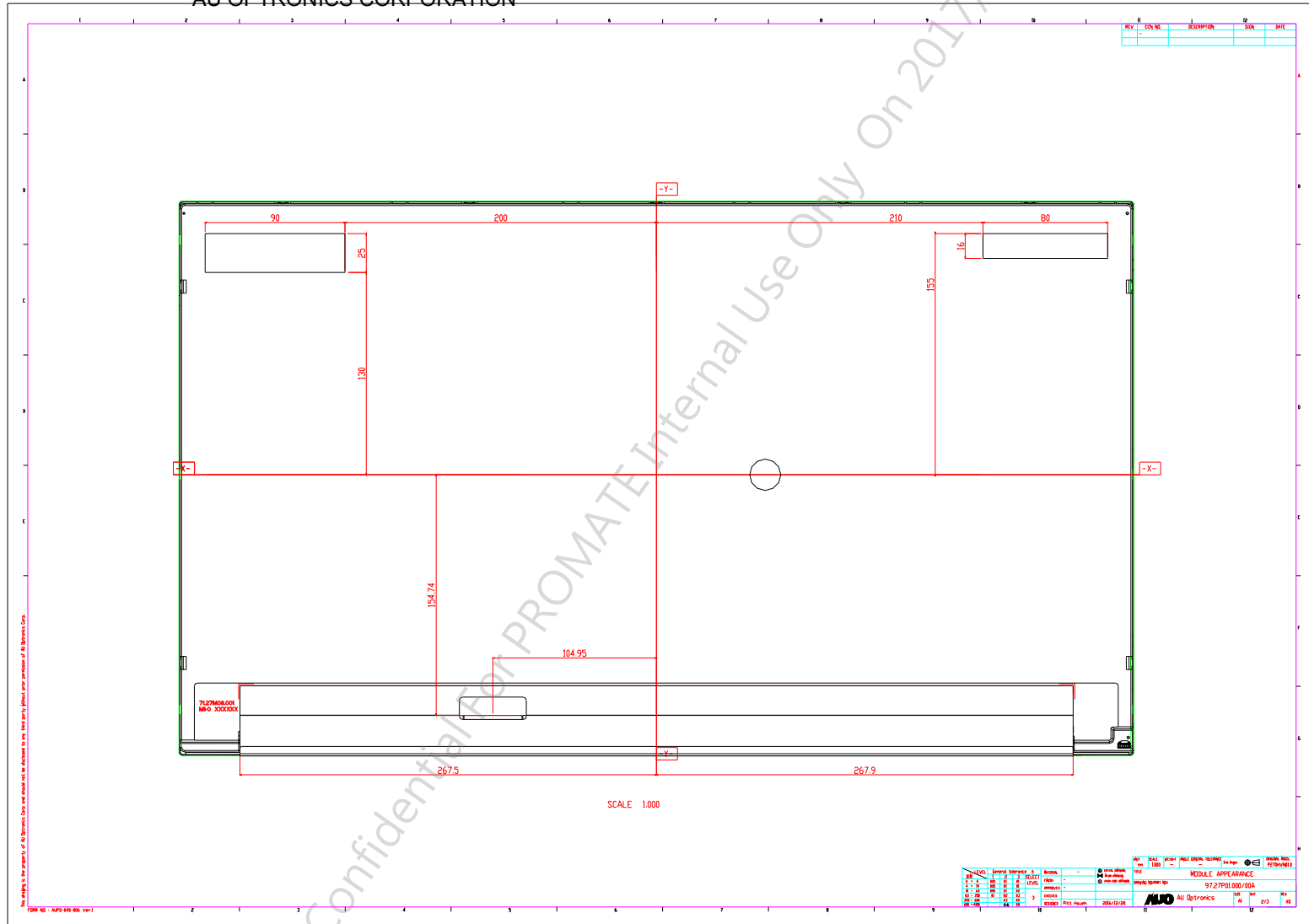



**Avoid touching COF position  
when doing mechanical design**

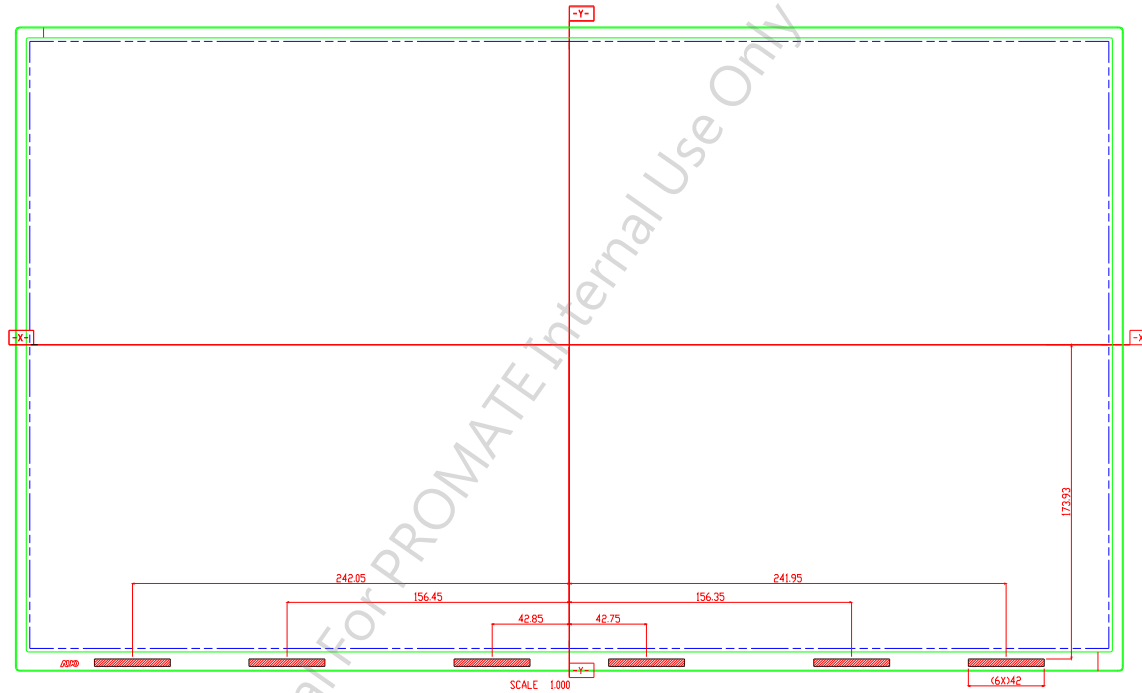

REV	CON. NO.	DESCRIPTION	DATE	BY
1				

NO.	REV.	DATE	DESCRIPTION
1	1	2016/12/28	ISSUE
2	2	2017/01/05	REVISED
3	3	2017/01/05	REVISED

NO.	REV.	DATE	DESCRIPTION
1	1	2016/12/28	ISSUE
2	2	2017/01/05	REVISED
3	3	2017/01/05	REVISED

## 11 Packing Specification

### 11.1 Packing Flow



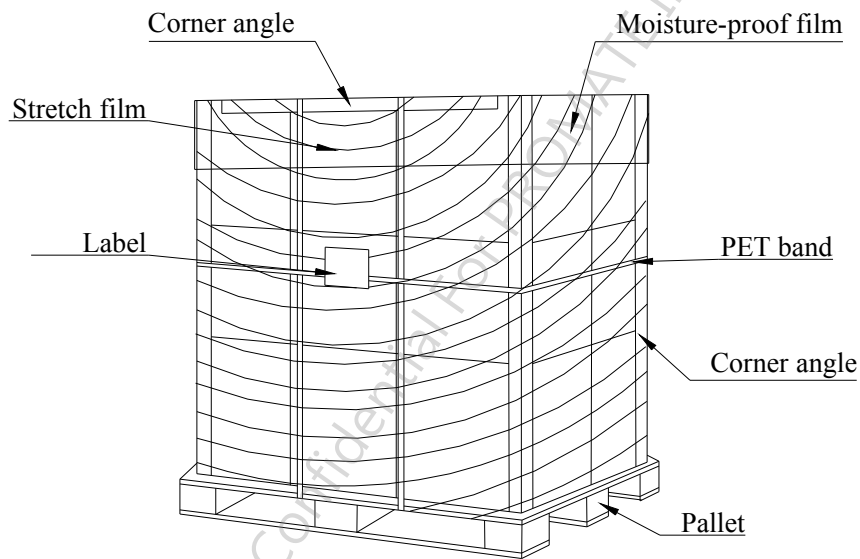
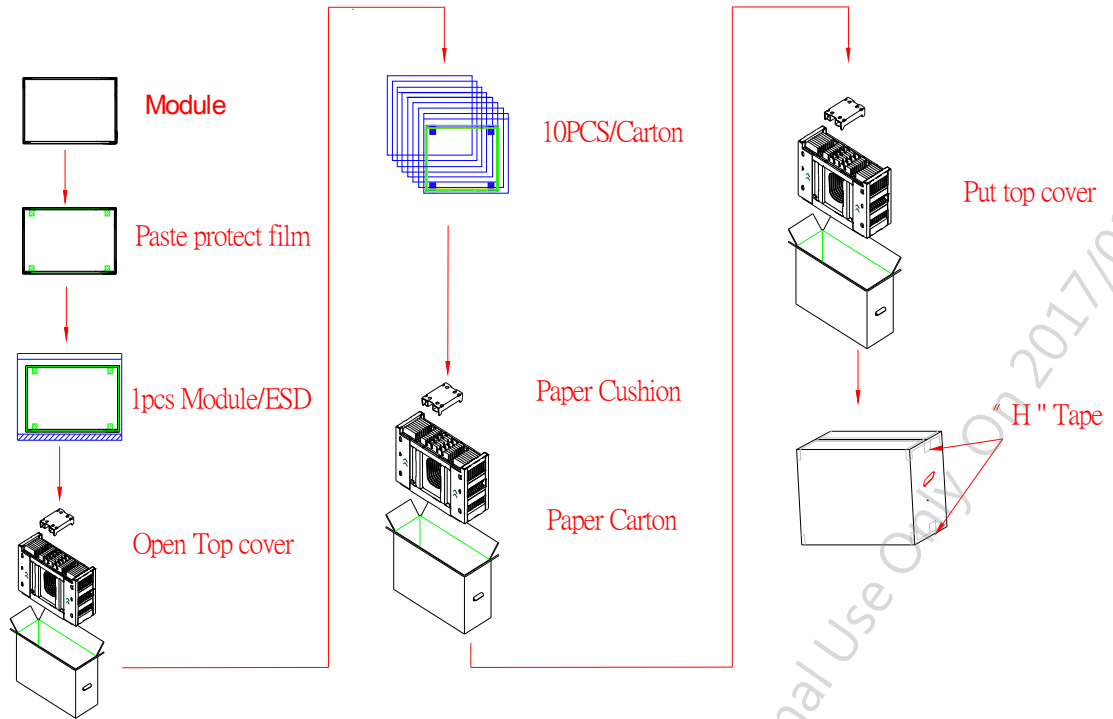

## 11-2 Pallet and shipment information

	Item	Specification			Remark
		Q'ty	Dimension	Weight(kg)	
1	Panel	1	613.6(H)mm x 356.85(V)mm x 10(D)mm	2.180	
2	Cushion	1	-	4.41	
3	Box	1	708(L)mm x 261(W)mm x 473(H)mm	1.38	without Panel & cushion
4	Packing Box	10 pcs/Box	708(L)mm x 261(W)mm x 473(H)mm	27.13	with panel & cushion
5	Pallet	1	1070(L)mm x 740(W)mm x 138(H)mm	12.9	
6	Pallet after Packing	8 boxes/pallet	1070(L)mm x 740(W)mm x 1084(H)mm	229.94	

AUO Confidential For PROMATE Internal Use Only On 2017/02/13