



IGBT Modules

V_{CEs}	1200V
I_C	50A

Applications

- Motor Drivers
- AC and DC servo drive amplifier
- UPS (Uninterruptible Power Supplies)

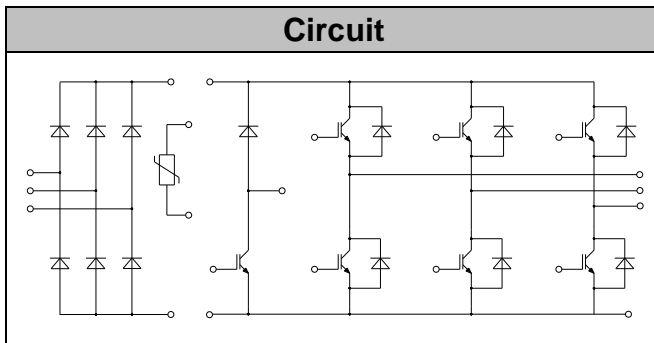

Features

- Low $V_{ce(sat)}$ with Planner technology
- Low $V_{ce(sat)}$ with positive temperature coefficient
- Including fast & soft recovery anti-parallel FWD
- Low inductance case
- High short circuit capability(10us)
- Maximum junction temperature 175°C

● IGBT- inverter

Absolute Maximum Ratings

Parameter	Symbol	Conditions	Value	Unit
Collector-Emitter Voltage	V_{CES}	$V_{GE}=0V, I_C=1mA, T_{vj}=25^{\circ}C$	1200	V
Continuous Collector Current	I_C	$T_C=80^{\circ}C, T_{vjmax}=150^{\circ}C$	50	A
Repetitive Peak Collector Current	I_{CRM}	$t_p=1ms$	100	A
Gate-Emitter Voltage	V_{GES}	$T_{vj}=25^{\circ}C$	± 20	V
Total Power Dissipation	P_{tot}	$T_C=25^{\circ}C, T_{vjmax}=150^{\circ}C$	368	W



Characteristic values

Parameter	Symbol	Conditions	Value			Unit	
			Min.	Typ.	Max.		
Gate-Emitter Threshold Voltage	$V_{GE(th)}$	$V_{GE}=V_{CE}, I_C=2mA, T_{vj}=25^{\circ}C$	5.0	5.8	6.5	V	
Collector-Emitter Cut-off Current	I_{CES}	$V_{CE}=1200V, V_{GE}=0V, T_{vj}=25^{\circ}C$			1.0	mA	
Collector-Emitter Saturation Voltage	$V_{CE(sat)}$	$I_C=50A, V_{GE}=15V, T_{vj}=25^{\circ}C$		1.95	2.25	V	
		$I_C=50A, V_{GE}=15V, T_{vj}=125^{\circ}C$		2.15			
		$I_C=50A, V_{GE}=15V, T_{vj}=150^{\circ}C$		2.20			
Gate Charge	Q_G			0.60		uC	
Input Capacitance	C_{ies}	$V_{CE}=25V, V_{GE}=0V,$ $f=1MHz, T_{vj}=25^{\circ}C$		3.80		nF	
Reverse Transfer Capacitance	C_{res}			0.26		nF	
Internal Gate Resistance	R_{gint}			2.5		Ω	
Gate-Emitter leakage current	I_{GES}	$V_{CE}=0V, V_{GE}=20V, T_{vj}=25^{\circ}C$			400	nA	
Turn-on Delay Time	$t_{d(on)}$	$I_C=50A$ $V_{CE}=600V$ $V_{GE}=\pm 15V$ $R_G=15\Omega$ $T_{vj}=25^{\circ}C$		40		ns	
Rise Time	t_r			65		ns	
Turn-off Delay Time	$t_{d(off)}$			390		ns	
Fall Time	t_f			36		ns	
Energy Dissipation During Turn-on Time	E_{on}			6.05		mJ	
Energy Dissipation During Turn-off Time	E_{off}			3.30		mJ	
Turn-on Delay Time	$t_{d(on)}$		$I_C=50A$ $V_{CE}=600V$ $V_{GE}=\pm 15V$ $R_G=15\Omega$ $T_{vj}=125^{\circ}C$		45		ns
Rise Time	t_r				70		ns
Turn-off Delay Time	$t_{d(off)}$			440		ns	
Fall Time	t_f			41		ns	
Energy Dissipation During Turn-on Time	E_{on}			8.0		mJ	
Energy Dissipation During Turn-off Time	E_{off}			5.50		mJ	
SC Data	I_{sc}	$T_p \leq 10\mu s, V_{GE}=15V, T_{vj}=150^{\circ}C,$ $V_{cc}=900V, V_{CEM} \leq 1200V$			320		A



● Diode-inverter

Absolute Maximum Ratings

Parameter	Symbol	Conditions	Value	Unit
Repetitive Peak Reverse Voltage	V_{RRM}	$T_{vj}=25^{\circ}\text{C}$	1200	V
Continuous DC Forward Current	I_F		50	A
Repetitive Peak Forward Current	I_{FRM}	$t_p=1\text{ms}$	100	A

Characteristic values

Parameter	Symbol	Conditions	Value			Unit
			Min.	Typ.	Max.	
Forward Voltage	V_F	$I_F=50\text{A}, T_{vj}=25^{\circ}\text{C}$		1.95	2.25	V
		$I_F=50\text{A}, T_{vj}=125^{\circ}\text{C}$		2.05		
		$I_F=50\text{A}, T_{vj}=150^{\circ}\text{C}$		2.10		
Recovered Charge	Q_{rr}	$I_F=50\text{A}$		3.5		μC
Peak Reverse Recovery Current	I_{rr}	$V_R=600\text{V}$ $-di_F/dt=900\text{A}/\mu\text{s}$		40		A
Reverse Recovery Energy	E_{rec}	$T_{vj}=25^{\circ}\text{C}$		1.35		mJ
Recovered Charge	Q_{rr}	$I_F=50\text{A}$		6.5		μC
Peak Reverse Recovery Current	I_{rr}	$V_R=600\text{V}$ $-di_F/dt=900\text{A}/\mu\text{s}$		50		A
Reverse Recovery Energy	E_{rec}	$T_{vj}=125^{\circ}\text{C}$		2.00		mJ



● **IGBT-brake-chopper**

Absolute Maximum Ratings

Parameter	Symbol	Conditions	Value	Unit
Collector-Emitter Voltage	V_{CES}	$V_{GE}=0V, I_C=1mA, T_{vj}=25^{\circ}C$	1200	V
Continuous Collector Current	I_C	$T_C=100^{\circ}C, T_{vjmax}=175^{\circ}C$	40	A
Repetitive Peak Collector Current	I_{CRM}	$t_p=1ms$	80	A
Gate-Emitter Voltage	V_{GES}	$T_{vj}=25^{\circ}C$	± 20	V
Total Power Dissipation	P_{tot}	$T_C=25^{\circ}C, T_{vjmax}=175^{\circ}C$	300	W

Characteristic values

Parameter	Symbol	Conditions	Value			Unit
			Min.	Typ.	Max.	
Gate-Emitter Threshold Voltage	$V_{GE(th)}$	$V_{GE}=V_{CE}, I_C=1.2mA, T_{vj}=25^{\circ}C$	5.8	6.7	7.2	V
Collector-Emitter Cut-off Current	I_{CES}	$V_{CE}=1200V, V_{GE}=0V, T_{vj}=25^{\circ}C$			1.0	mA
Collector-Emitter Saturation Voltage	$V_{CE(sat)}$	$I_C=40A, V_{GE}=15V, T_{vj}=25^{\circ}C$		1.95	2.35	V
		$I_C=40A, V_{GE}=15V, T_{vj}=125^{\circ}C$		2.30		
		$I_C=40A, V_{GE}=15V, T_{vj}=150^{\circ}C$		2.40		
Gate Charge	Q_G			0.27		uC
Input Capacitance	C_{ies}	$V_{CE}=25V, V_{GE}=0V, f=1MHz, T_{vj}=25^{\circ}C$		2.00		nF
Reverse Transfer Capacitance	C_{res}			0.07		nF
Gate-Emitter leakage current	I_{GES}	$V_{CE}=0V, V_{GE}=20V, T_{vj}=25^{\circ}C$			400	nA
Turn-on Delay Time	$t_{d(on)}$	$I_C=40A, V_{CE}=600V, V_{GE}=\pm 15V, R_G=12\Omega, T_{vj}=25^{\circ}C$		28		ns
Rise Time	t_r			16		ns
Turn-off Delay Time	$t_{d(off)}$			26		ns
Fall Time	t_f			125		ns
Energy Dissipation During Turn-on Time	E_{on}			2.40		mJ
Energy Dissipation During Turn-off Time	E_{off}			2.25		mJ



Turn-on Delay Time	$t_{d(on)}$	$I_C = 40\text{ A}$ $V_{CE} = 600\text{ V}$ $V_{GE} = \pm 15\text{ V}$ $R_G = 12\Omega$ $T_{vj} = 125^\circ\text{C}$		28		ns
Rise Time	t_r			18		ns
Turn-off Delay Time	$t_{d(off)}$			310		ns
Fall Time	t_f			190		ns
Energy Dissipation During Turn-on Time	E_{on}			3.60		mJ
Energy Dissipation During Turn-off Time	E_{off}			3.20		mJ
SC Data	I_{sc}		$T_p \leq 10\mu\text{s}, V_{GE} = 15\text{ V}, T_{vj} = 150^\circ\text{C},$ $V_{cc} = 900\text{ V}, V_{CEM} \leq 1200\text{ V}$		130	

● **Diode-Brake-Chopper**

Absolute Maximum Ratings

Parameter	Symbol	Conditions	Value	Unit
Repetitive Peak Reverse Voltage	V_{RRM}	$T_j = 25^\circ\text{C}$	1200	V
Continuous DC Forward Current	I_F		40	A
Repetitive Peak Forward Current	I_{FRM}	$t_p = 1\text{ ms}$	80	A
I^2t -value	I^2t	$V_R = 0, t_p = 10\text{ ms}, T_j = 125^\circ\text{C}$	240	A ² s
		$V_R = 0, t_p = 10\text{ ms}, T_j = 150^\circ\text{C}$	220	

Characteristic values

Parameter	Symbol	Conditions	Value			Unit
			Min.	Typ.	Max.	
Forward Voltage	V_F	$I_F = 40\text{ A}, T_{vj} = 25^\circ\text{C}$		1.75	2.25	V
		$I_F = 40\text{ A}, T_{vj} = 125^\circ\text{C}$		1.75		
		$I_F = 40\text{ A}, T_{vj} = 150^\circ\text{C}$		1.75		
Recovered Charge	Q_{rr}	$I_F = 40\text{ A}$		4.15		μC
Peak Reverse Recovery Current	I_{rr}	$V_R = 600\text{ V}$ $-di_F/dt = 1600\text{ A}/\mu\text{s}$		42		A
Reverse Recovery Energy	E_{rec}	$T_{vj} = 25^\circ\text{C}$		1.30		mJ



Recovered Charge	Q_{rr}	$I_F = 40\text{ A}$ $V_R = 600\text{ V}$ $-di_F/dt = 1600\text{ A/us}$ $T_{vj} = 125^\circ\text{C}$		8.00		μC
Peak Reverse Recovery Current	I_{rr}			46		A
Reverse Recovery Energy	E_{rec}			2.38		mJ

● Diode-Rectifier

Absolute Maximum Ratings

Parameter	Symbol	Conditions	Value	Unit
Repetitive Peak Reverse Voltage	V_{RRM}	$T_j = 25^\circ\text{C}$	1600	V
Average On-state Current 50/60Hz, sine wave	$I_{F(AV)}$	$T_c = 100^\circ\text{C}$	65	A
Maximum RMS Current at Rectifier Output	I_{RMSM}	$T_c = 100^\circ\text{C}$	110	A
Surge Forward Current	I_{FSM}	$V_R = 0, t_p = 10\text{ms}, T_j = 45^\circ\text{C}$	850	A
I^2t -value	I^2t	$V_R = 0, t_p = 10\text{ms}, T_j = 45^\circ\text{C}$	3610	A^2s

Characteristic values

Parameter	Symbol	Conditions	Value			Unit
			Min.	Typ.	Max.	
Diode Forward Voltage	V_F	$I_F = 50\text{ A}, T_j = 150^\circ\text{C}$		1.00		V
Reverse Current	I_R	$T_j = 125^\circ\text{C}, V_R = 1600\text{ V}$			1.5	mA

● NTC-Thermistor

Characteristic values

Parameter	Symbol	Conditions	Value			Unit
			Min.	Typ.	Max.	
Rated Resistance	R_{25}			5.0		$\text{k}\Omega$
Deviation of R_{100}	$\Delta R/R$	$T_C = 100, R_{100} = 493.3\Omega$	-5		5	%
Power Dissipation	P_{25}			20.0		mW
B-value	$B_{25/50}$	$R_2 = R_{25} \exp[B_{25/50}(1/T_2 - 1/(298.15\text{K}))]$		3375		K



● **Module Characteristics** $T_C=25^{\circ}\text{C}$ unless otherwise specified

Parameter	Symbol	Conditions	Value			Unit
			Min.	Typ.	Max.	
Isolation voltage	V_{isol}	$t=1\text{min}, f=50\text{Hz}$	2500			V
Maximum Junction Temperature	T_{jmax}	Inverter, brake			175	$^{\circ}\text{C}$
		rectifier			150	
Operating Junction Temperature	$T_{vj\ op}$		-40		150	$^{\circ}\text{C}$
Storage Temperature	T_{stg}		-40		125	$^{\circ}\text{C}$
Stray Inductance	L_{CE}			60		nH
Module Lead Resistance ,Terminal to Chip	$R_{cc'+EE'}$	$T_C=25^{\circ}\text{C}$, per switch		4.0		m Ω
	$R_{AA'+CC'}$			2.0		
Thermal Resistance Junction-to Case	$R_{\theta jc}$	per IGBT-inverter			0.339	K/W
		per Diode-inverter			0.619	
		per IGBT-brake-copper			0.500	
		per Diode-chopper			1.266	
		per Diode-rectifier			0.635	
Thermal Resistance Case-to Sink	$R_{\theta cs}$	per IGBT-inverter		0.121		K/W
		per Diode-inverter		0.221		
		per IGBT-brake-copper		0.180		
		per Diode-chopper		0.452		
		per Diode-rectifier		0.227		
		per Module		0.009		
Module-to-Sink Torque	M_s		3.0		6.0	N·m
Weight of Module	G			300		g

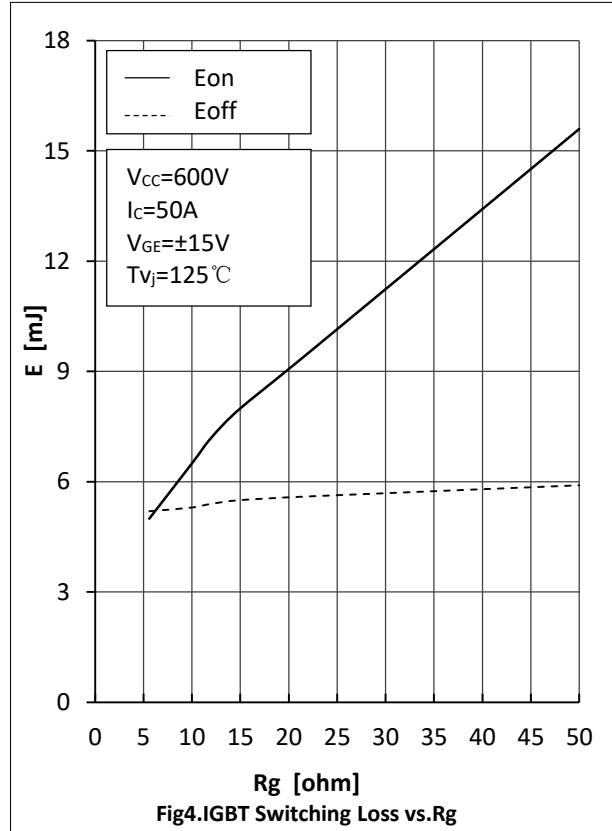
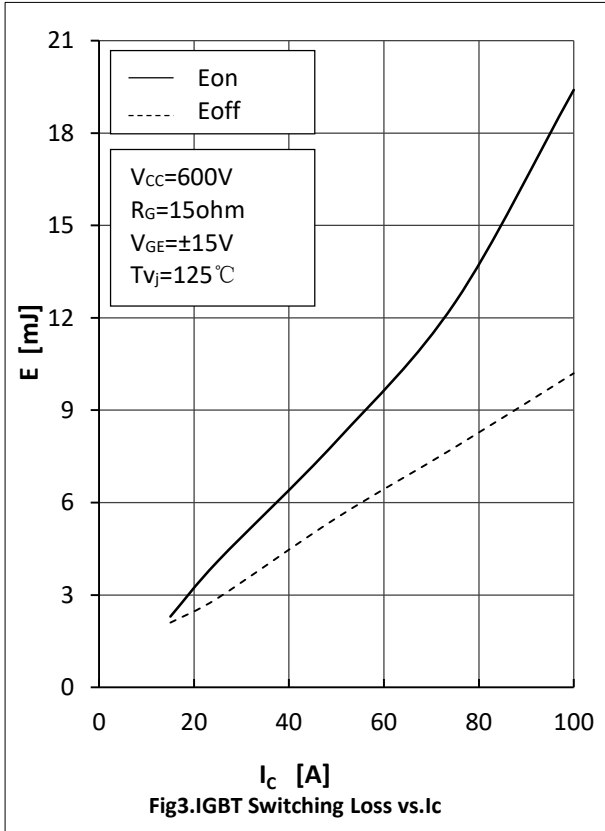
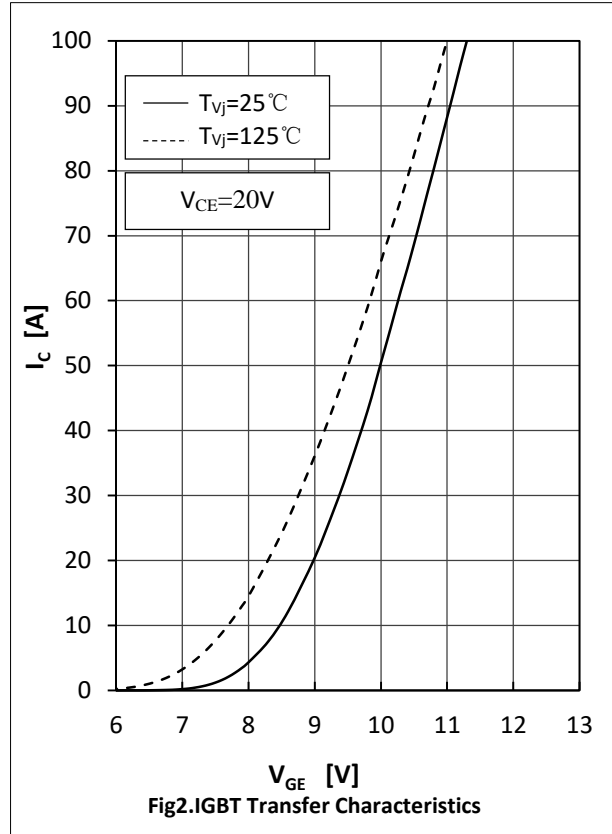
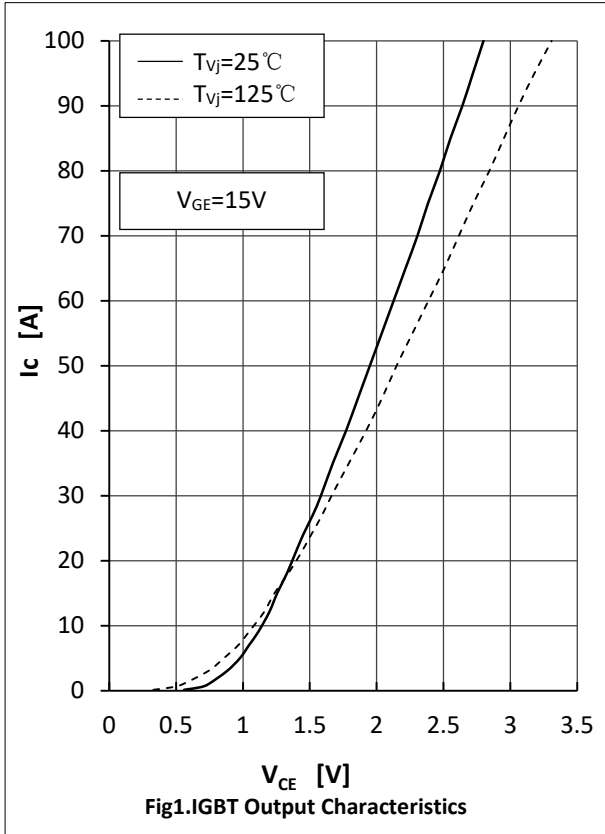

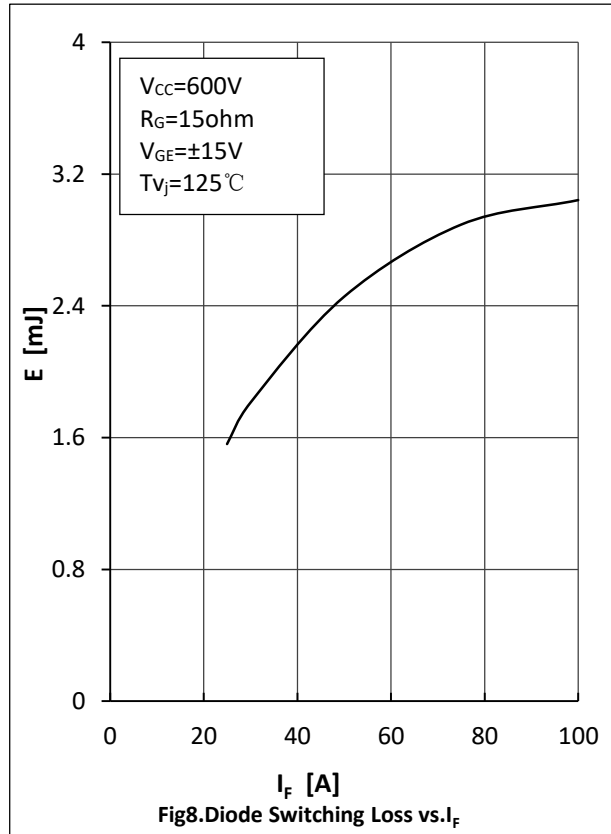
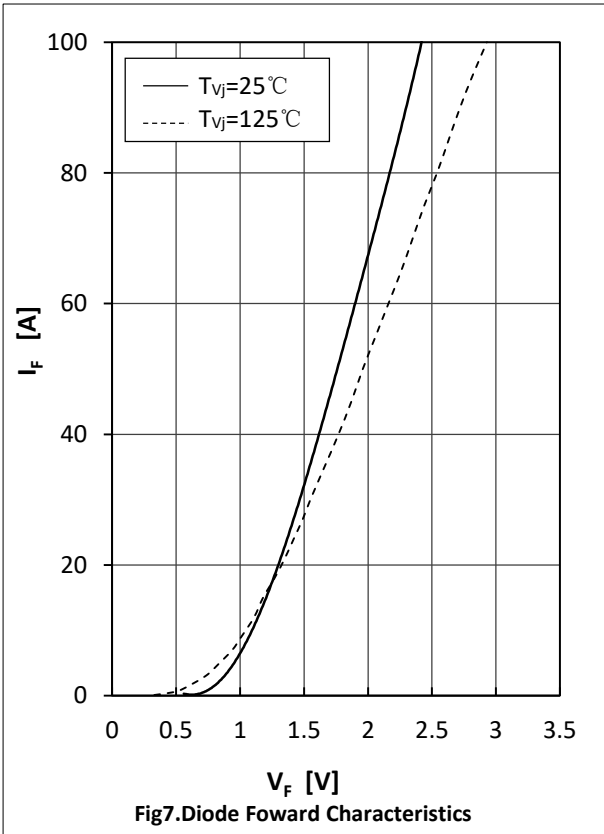
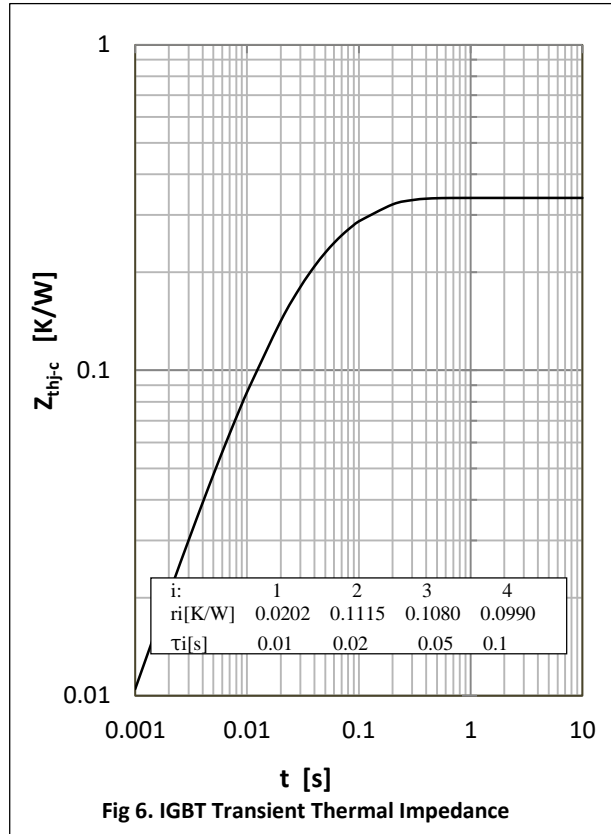
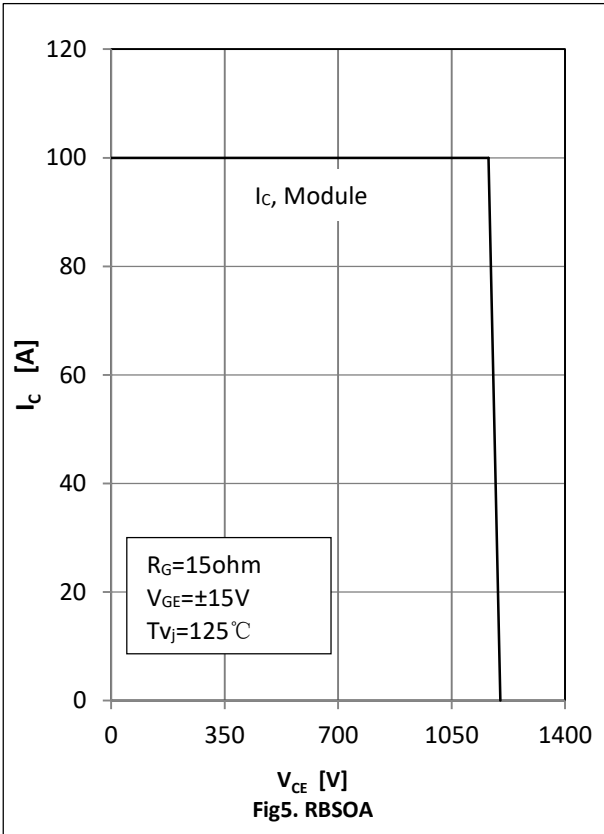

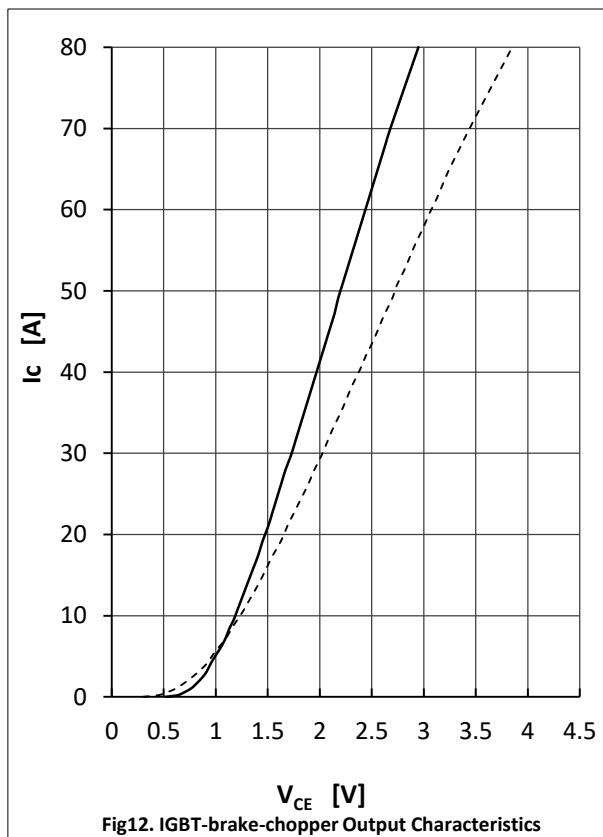
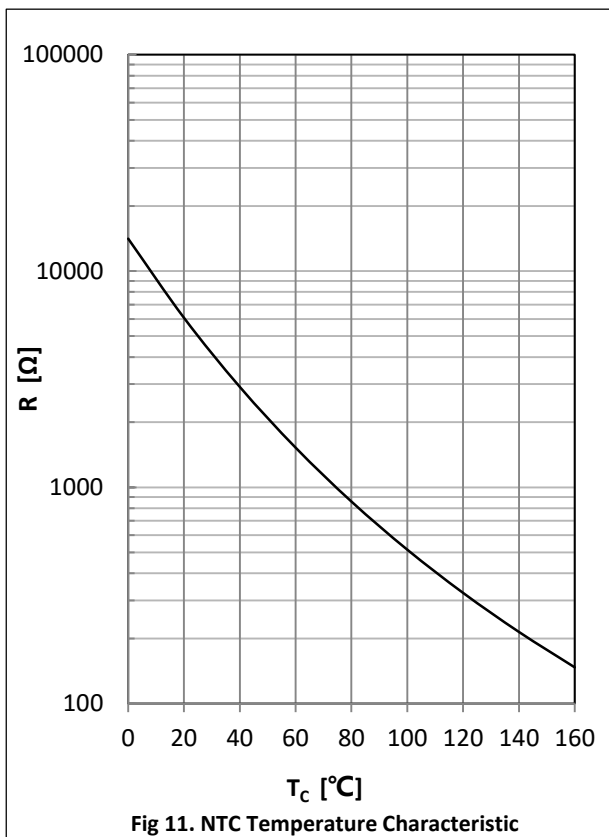
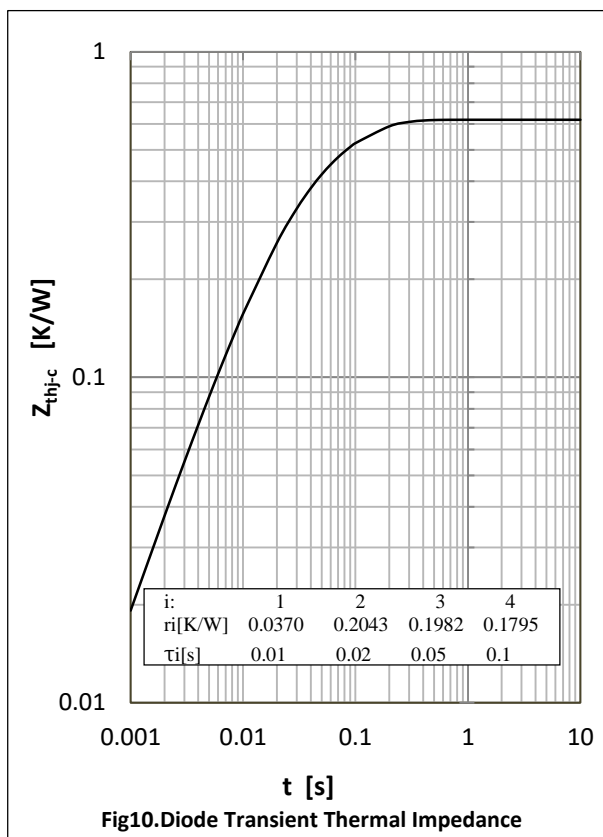
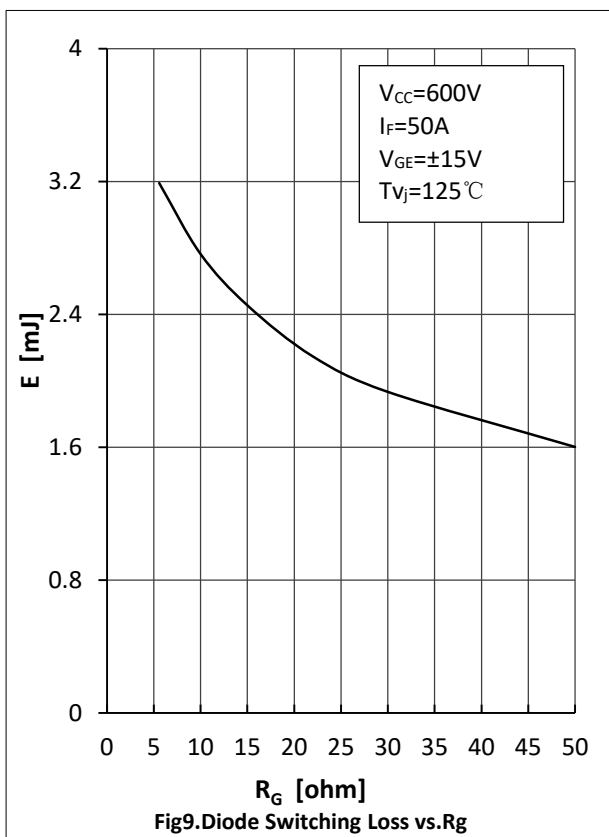

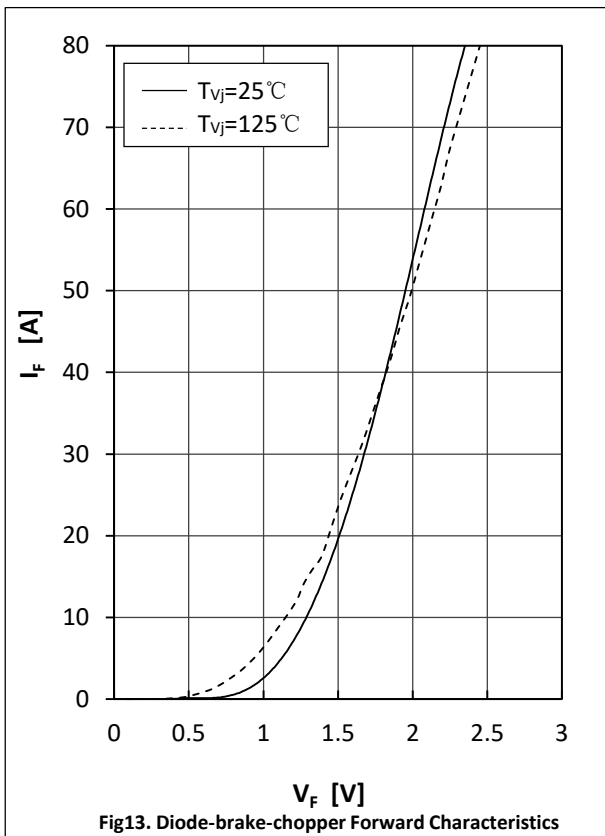

● **Circuit Diagram**

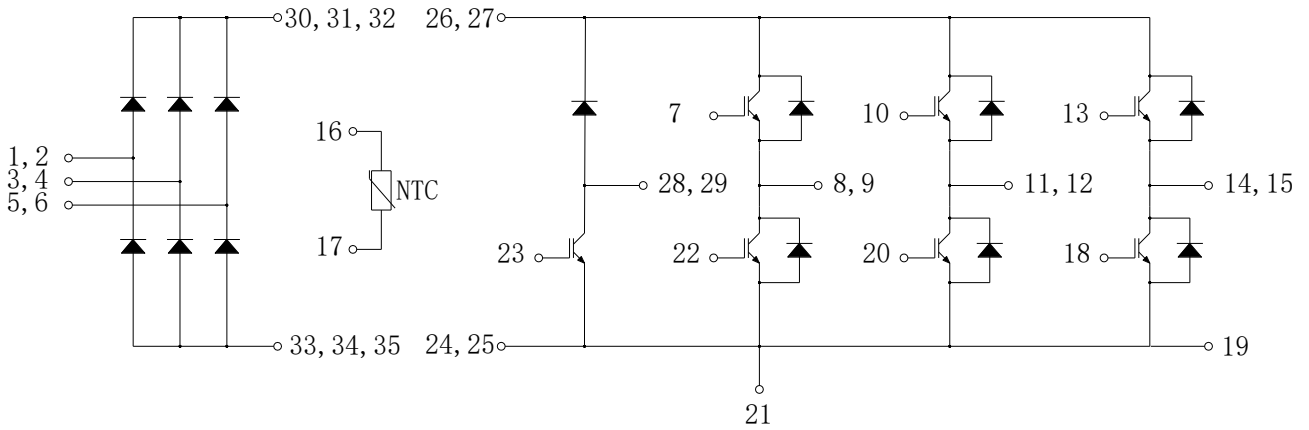

● **Package Dimensions**

