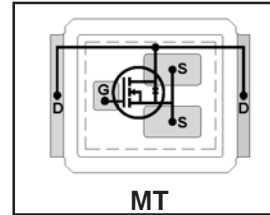


DirectFET™ Power MOSFET ②

Typical values (unless otherwise specified)

V _{DSS}	V _{GS}	R _{DS(on)}	R _{DS(on)}
30V max	±20V max	1.3mΩ@10V	1.9mΩ@4.5V

- Ultra-low R_{DS(on)}
- Low Profile (<0.7 mm)
- Dual Sided Cooling Compatible ①
- Ultra-low Package Inductance
- Optimized for high speed switching or high current switch (Power Tool)
- Low Conduction and Switching Losses
- Compatible with existing Surface Mount Techniques ①



Applicable DirectFET Outline and Substrate Outline (see p.7,8 for details)①

SQ	SX	ST		MQ	MX	MT	MP			
----	----	----	--	----	----	-----------	----	--	--	--

Description

The IRF8301MPbF combines the latest HEXFET® Power MOSFET Silicon technology with the advanced DirectFET™ packaging to achieve very low on-state resistance in a package that has the footprint of an SO-8 or a PQFN 5x6mm and only 0.7mm profile. The DirectFET package is compatible with existing layout geometries used in power applications, PCB assembly equipment and vapor phase, infra-red or convection soldering techniques, when application note AN-1035 is followed regarding the manufacturing methods and processes. The DirectFET package allows dual sided cooling to maximize thermal transfer in power systems, improving previous best thermal resistance by 80%.

The IRF8301MPbF balances both low resistance and low charge along with ultra low package inductance to reduce both conduction and switching losses. The reduced total losses and very high current carrying capability make this product ideal for power tools.

Ordering Information

Base Part Number	Package Type	Standard Pack		Orderable Part Number
		Form	Quantity	
IRF8301MPbF	DirectFET MT	Tape and Reel	4800	IRF8301MTRPbF

Absolute Maximum Ratings

Parameter	Max.	Units
V _{GS} Gate-to-Source Voltage	±20	
I _D @ T _A = 25°C Continuous Drain Current, V _{GS} @ 10V ③	34	A
I _D @ T _A = 70°C Continuous Drain Current, V _{GS} @ 10V ③	27	
I _D @ T _C = 25°C Continuous Drain Current, V _{GS} @ 10V ④	192	
I _{DM} Pulsed Drain Current ⑤	250	
E _{AS} Single Pulse Avalanche Energy ⑥	260	mJ
I _{AR} Avalanche Current ⑦	25	A

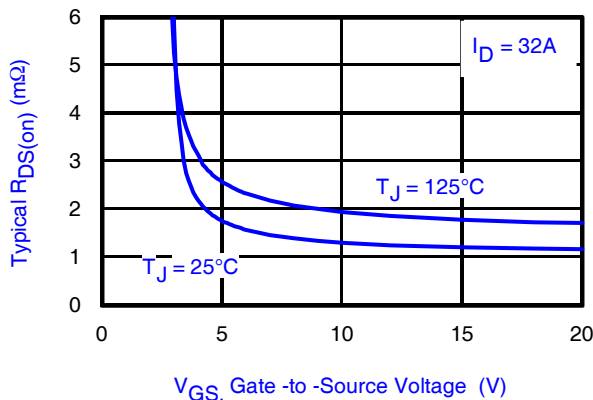


Fig 1. Typical On-Resistance vs. Gate Voltage

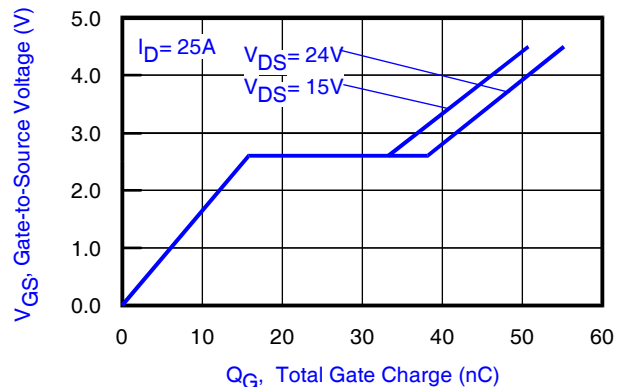
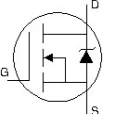


Fig 2. Typical Total Gate Charge vs. Gate-to-Source Voltage

Static @ $T_J = 25^\circ\text{C}$ (unless otherwise specified)

	Parameter	Min.	Typ.	Max.	Units	Conditions
BV_{DSS}	Drain-to-Source Breakdown Voltage	30	—	—	V	$V_{GS} = 0V, I_D = 250\mu A$
$\Delta BV_{DSS}/\Delta T_J$	Breakdown Voltage Temp. Coefficient	—	21	—	mV/°C	Reference to $25^\circ\text{C}, I_D = 1\text{mA}$
$R_{DS(on)}$	Static Drain-to-Source On-Resistance	—	1.3	1.5	mΩ	$V_{GS} = 10V, I_D = 32A$ ⑦
		—	1.9	2.4		$V_{GS} = 4.5V, I_D = 25A$ ⑦
$V_{GS(th)}$	Gate Threshold Voltage	1.35	1.7	2.35	V	$V_{DS} = V_{GS}, I_D = 150\mu A$
$\Delta V_{GS(th)}/\Delta T_J$	Gate Threshold Voltage Coefficient	—	-6.0	—	mV/°C	
I_{DSS}	Drain-to-Source Leakage Current	—	—	1.0	μA	$V_{DS} = 24V, V_{GS} = 0V$
		—	—	150		$V_{DS} = 24V, V_{GS} = 0V, T_J = 125^\circ\text{C}$
I_{GSS}	Gate-to-Source Forward Leakage	—	—	100	nA	$V_{GS} = 20V$
	Gate-to-Source Reverse Leakage	—	—	-100		$V_{GS} = -20V$
g_{fs}	Forward Transconductance	150	—	—	S	$V_{DS} = 15V, I_D = 25A$
Q_g	Total Gate Charge	—	51	77	nC	$V_{DS} = 15V$ $V_{GS} = 4.5V$ $I_D = 25A$ See Fig. 15
Q_{gs1}	Pre-V _{th} Gate-to-Source Charge	—	12	—		
Q_{gs2}	Post-V _{th} Gate-to-Source Charge	—	5.4	—		
Q_{gd}	Gate-to-Drain Charge	—	16	—		
Q_{godr}	Gate Charge Overdrive	—	18	—		
Q_{sw}	Switch Charge ($Q_{gs2} + Q_{gd}$)	—	21	—		
Q_{oss}	Output Charge	—	28	—	nC	$V_{DS} = 16V, V_{GS} = 0V$
R_G	Gate Resistance	—	1.0	3.0	Ω	
$t_{d(on)}$	Turn-On Delay Time	—	20	—	ns	$V_{DD} = 15V, V_{GS} = 4.5V$ ⑦ $I_D = 25A$ $R_G = 1.8\Omega$ See Fig. 17
t_r	Rise Time	—	30	—		
$t_{d(off)}$	Turn-Off Delay Time	—	25	—		
t_f	Fall Time	—	17	—		
C_{iss}	Input Capacitance	—	6140	—	pF	$V_{GS} = 0V$ $V_{DS} = 15V$ $f = 1.0\text{MHz}$
C_{oss}	Output Capacitance	—	1270	—		
C_{rss}	Reverse Transfer Capacitance	—	590	—		

Diode Characteristics

	Parameter	Min.	Typ.	Max.	Units	Conditions
I_S	Continuous Source Current (Body Diode)	—	—	110	A	MOSFET symbol showing the integral reverse p-n junction diode. 
I_{SM}	Pulsed Source Current (Body Diode) ⑤	—	—	250		
V_{SD}	Diode Forward Voltage	—	0.77	1.0	V	$T_J = 25^\circ\text{C}, I_S = 25A, V_{GS} = 0V$ ⑦
t_{rr}	Reverse Recovery Time	—	27	41	ns	$T_J = 25^\circ\text{C}, I_F = 25A$
Q_{rr}	Reverse Recovery Charge	—	45	68	nC	$di/dt = 500A/\mu s$ ⑦

Notes:

- ① Click on this section to link to the appropriate technical paper.
- ② Click on this section to link to the DirectFET Website.
- ③ Surface mounted on 1 in. square Cu board, steady state.

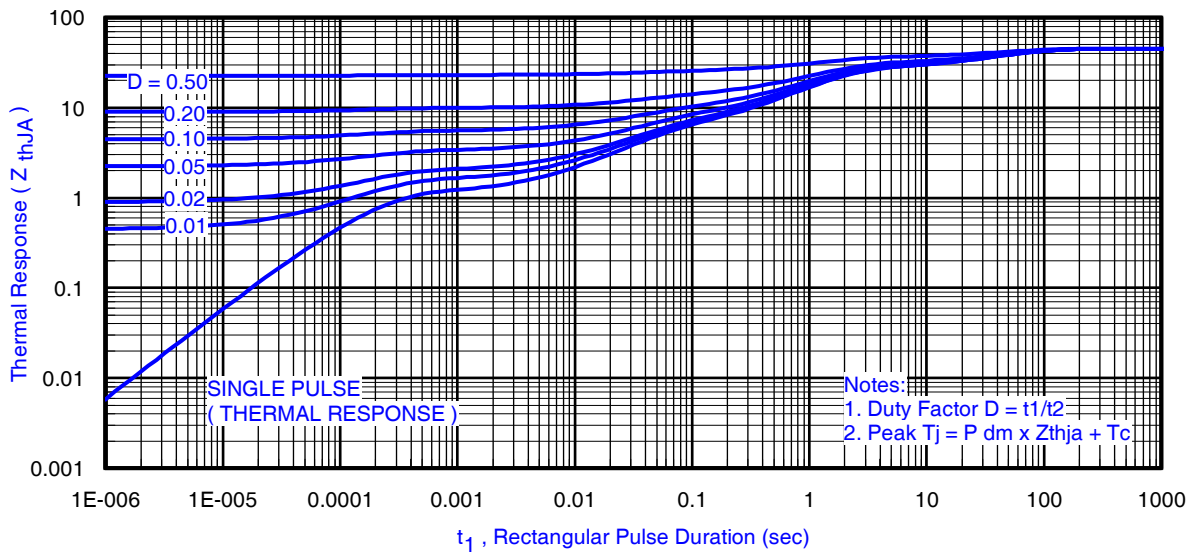
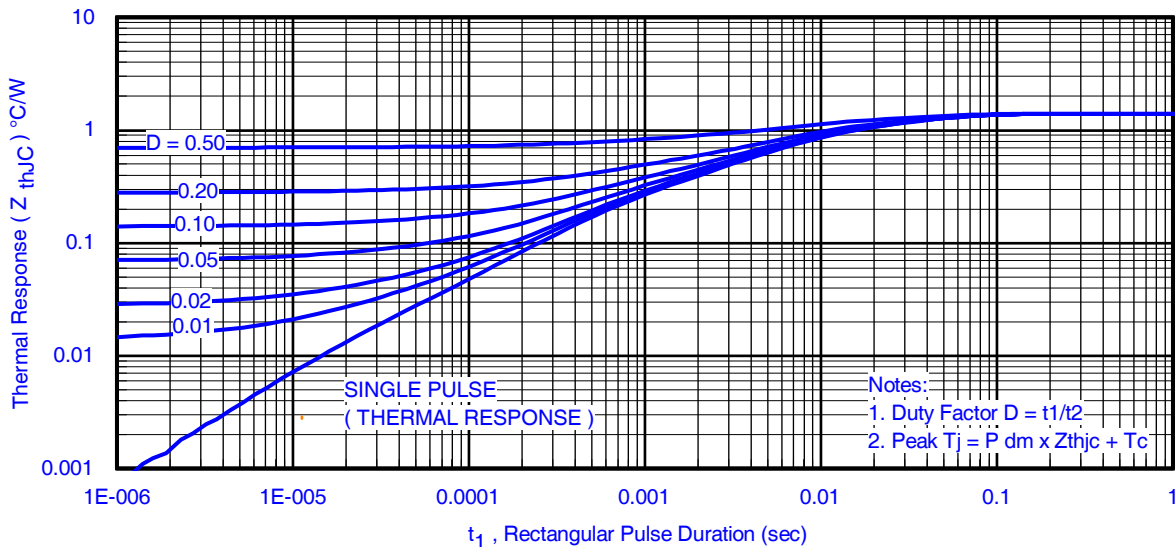
- ④ T_C measured with thermocouple mounted to top (Drain) of part.
- ⑤ Repetitive rating; pulse width limited by max. junction temperature.
- ⑥ Starting $T_J = 25^\circ\text{C}$, $L = 0.82\text{mH}$, $R_G = 25\Omega$, $I_{AS} = 25A$.
- ⑦ Pulse width $\leq 400\mu s$; duty cycle $\leq 2\%$.

Absolute Maximum Ratings

	Parameter	Max.	Units
$P_D @ T_A = 25^\circ\text{C}$	Power Dissipation ③	2.8	W
$P_D @ T_A = 70^\circ\text{C}$	Power Dissipation ③	1.8	
$P_D @ T_C = 25^\circ\text{C}$	Power Dissipation ④	89	
T_P	Peak Soldering Temperature	270	°C
T_J	Operating Junction and	-40 to +150	
T_{STG}	Storage Temperature Range		

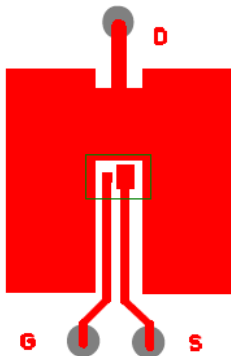
Thermal Resistance

	Parameter	Typ.	Max.	Units
$R_{\theta JA}$	Junction-to-Ambient ③⑩	—	45	°C/W
$R_{\theta JA}$	Junction-to-Ambient ⑧⑩	12.5	—	
$R_{\theta JA}$	Junction-to-Ambient ⑨⑩	20	—	
$R_{\theta JC}$	Junction-to-Case ④⑩	—	1.4	
$R_{\theta J-PCB}$	Junction-to-PCB Mounted	1.0	—	
	Linear Derating Factor ③	0.022		W/°C

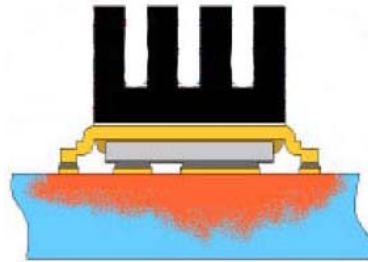

Fig 3. Maximum Effective Transient Thermal Impedance, Junction-to-Ambient ③

Fig 4. Maximum Effective Transient Thermal Impedance, Junction-to-Case

Notes:

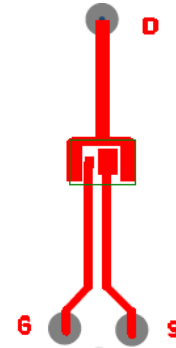
- ③ Used double sided cooling , mounting pad with large heatsink.
- ④ Mounted on minimum footprint full size board with metalized back and with small clip heatsink.
- ⑩ R_{θ} is measured at T_J of approximately 90°C.



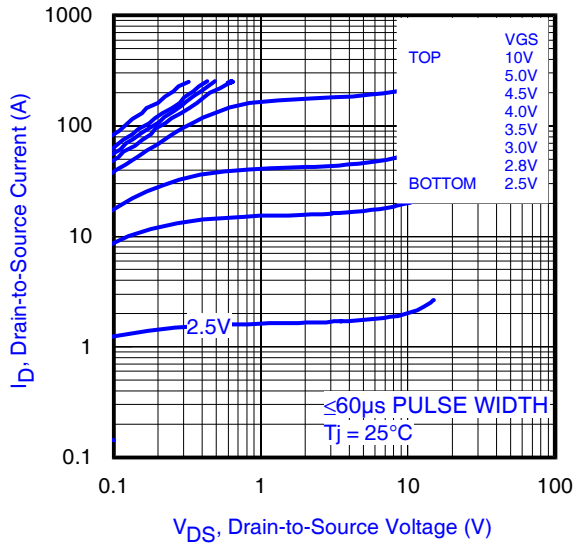
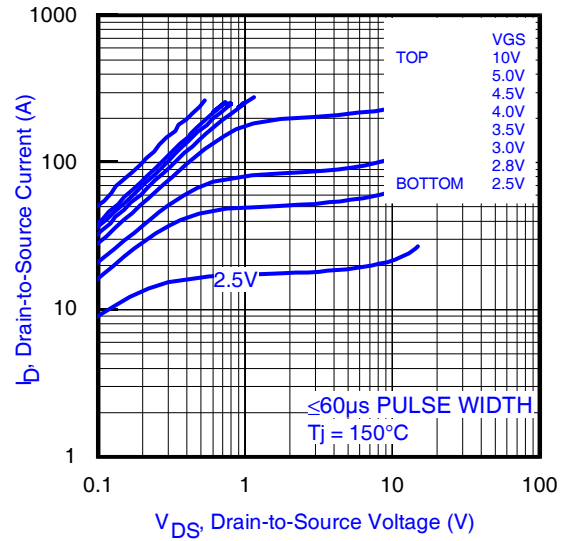
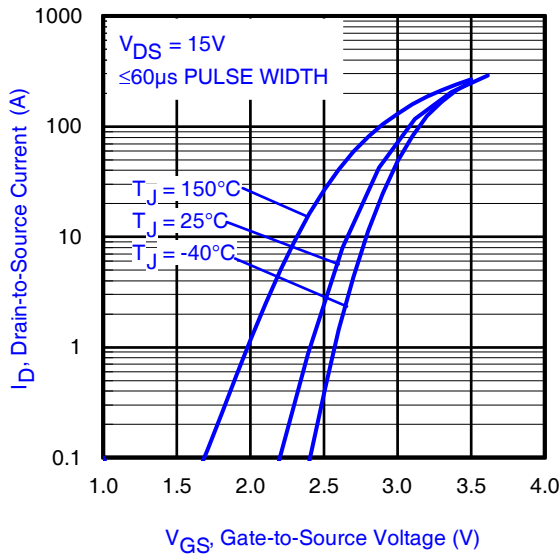
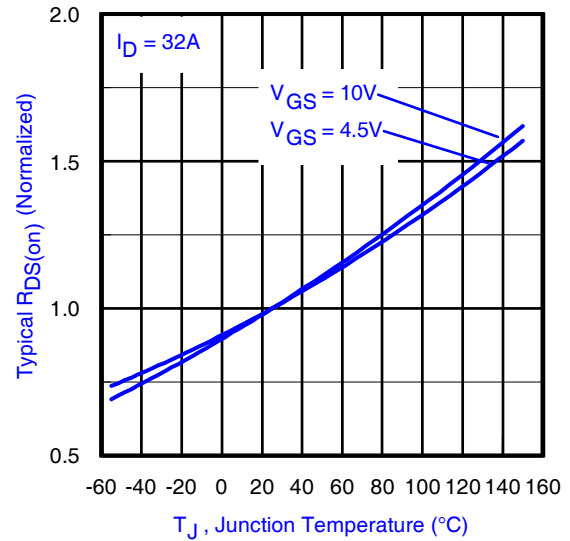
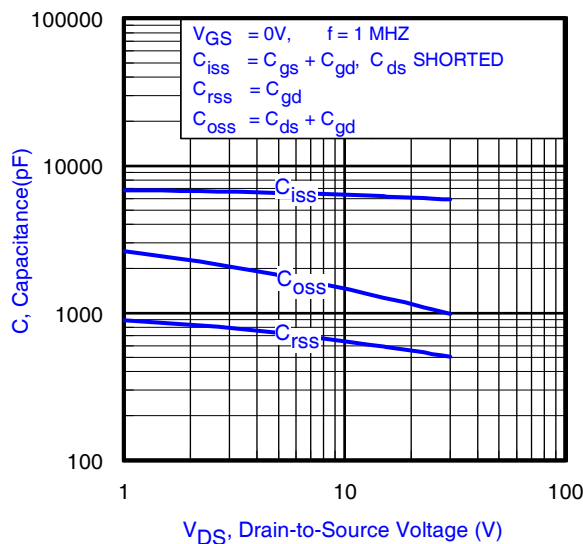
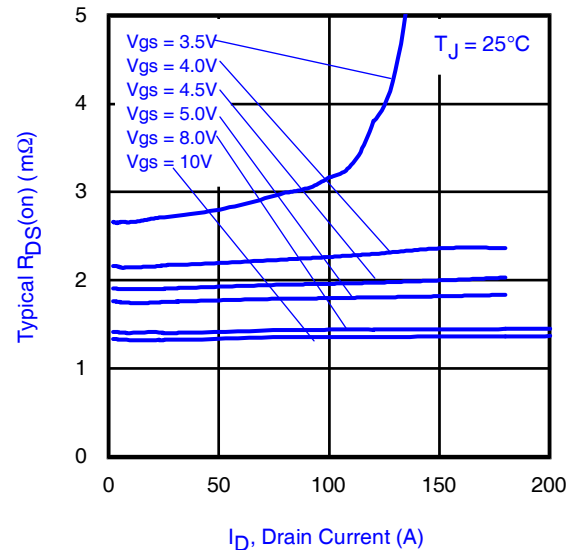
③ Surface mounted on 1 in. square Cu (still air).

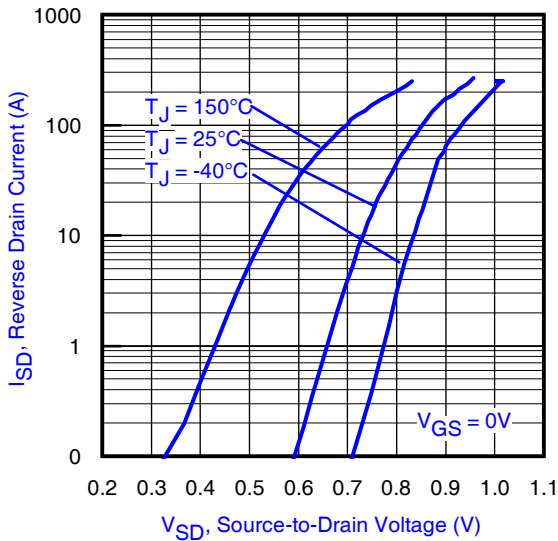
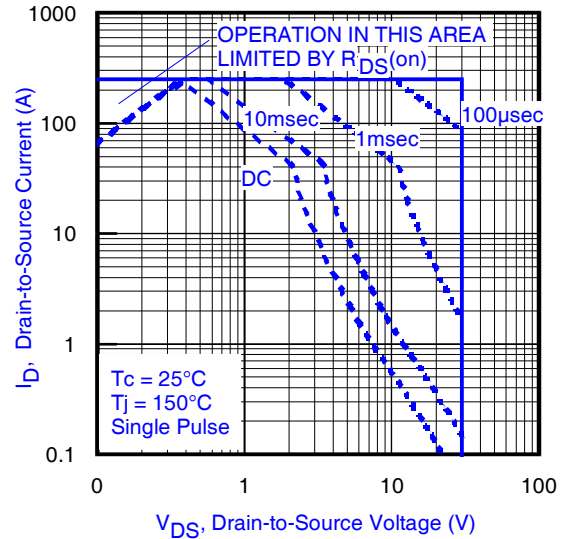
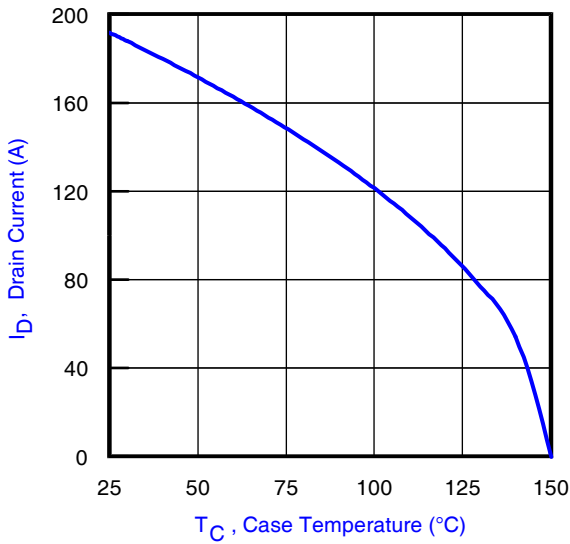
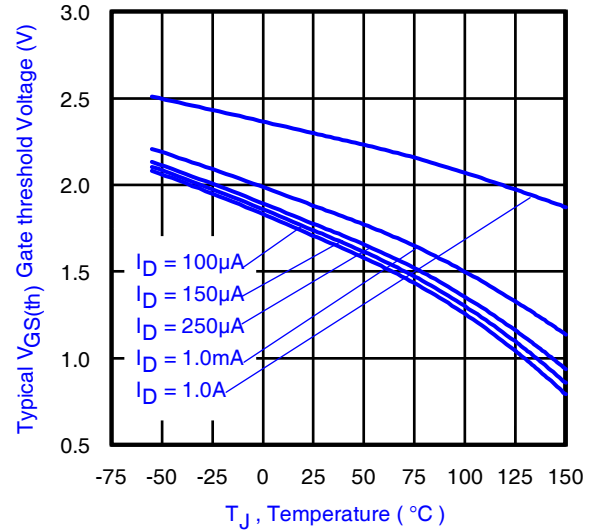
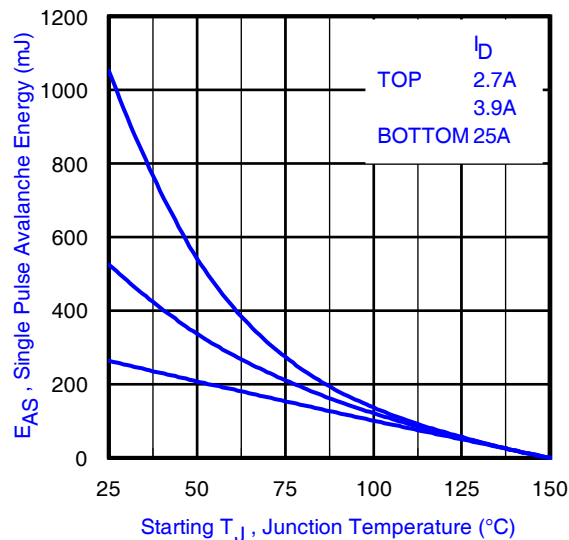


④ Mounted to a PCB with small clip heatsink (still air)



⑤ Mounted on minimum footprint full size board with metalized back and with small clip heatsink (still air)


Fig 5. Typical Output Characteristics

Fig 6. Typical Output Characteristics

Fig 7. Typical Transfer Characteristics

Fig 8. Normalized On-Resistance vs. Temperature

Fig 9. Typical Capacitance vs. Drain-to-Source Voltage

Fig 10. Typical On-Resistance vs. Drain Current and Gate Voltage


Fig 11. Typical Source-Drain Diode Forward Voltage

Fig 12. Maximum Safe Operating Area

Fig 13. Maximum Drain Current vs. Case Temperature

Fig 14. Typical Threshold Voltage vs. Junction Temperature

Fig 15. Maximum Avalanche Energy vs. Drain Current

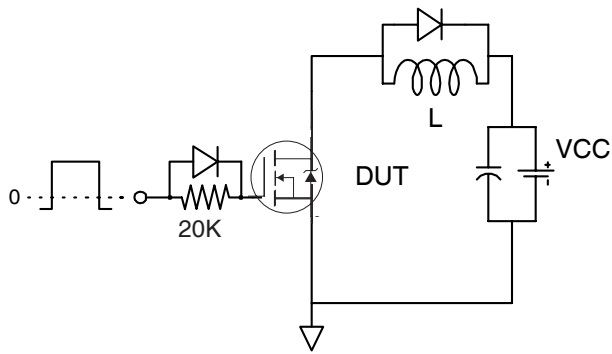


Fig 16a. Gate Charge Test Circuit

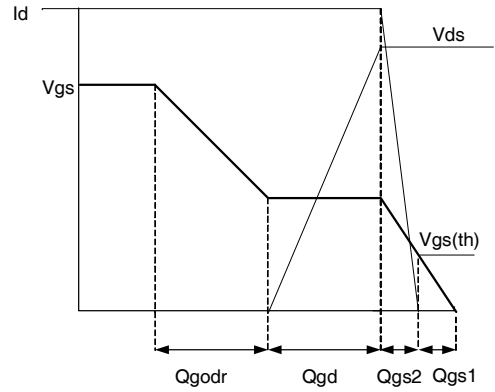


Fig 16b. Gate Charge Waveform

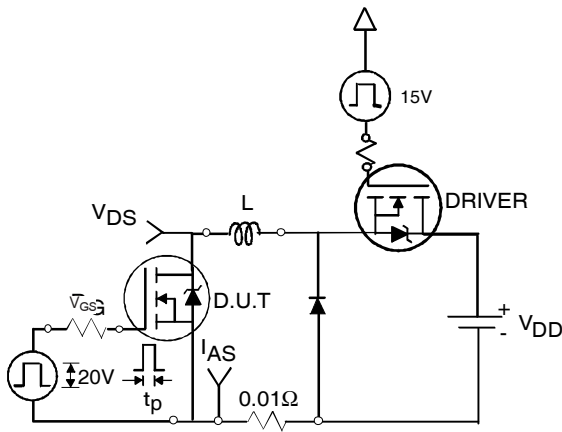


Fig 17a. Unclamped Inductive Test Circuit

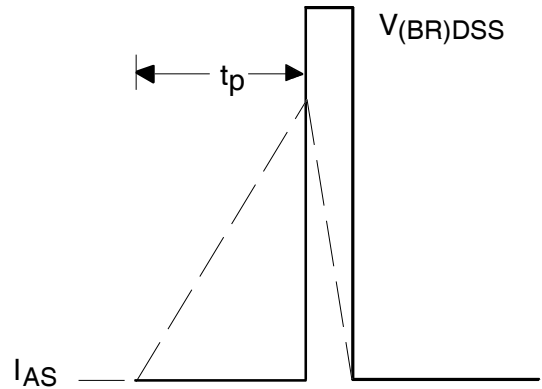


Fig 17b. Unclamped Inductive Waveforms

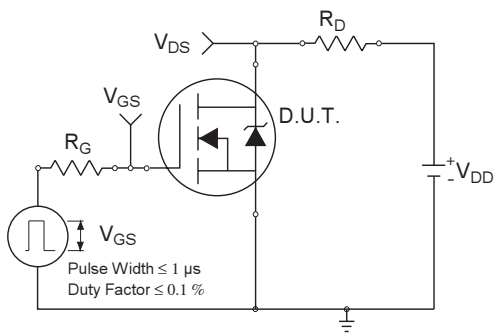


Fig 18a. Switching Time Test Circuit

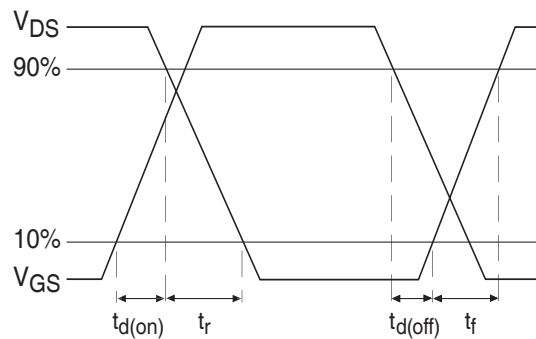


Fig 18b. Switching Time Waveforms

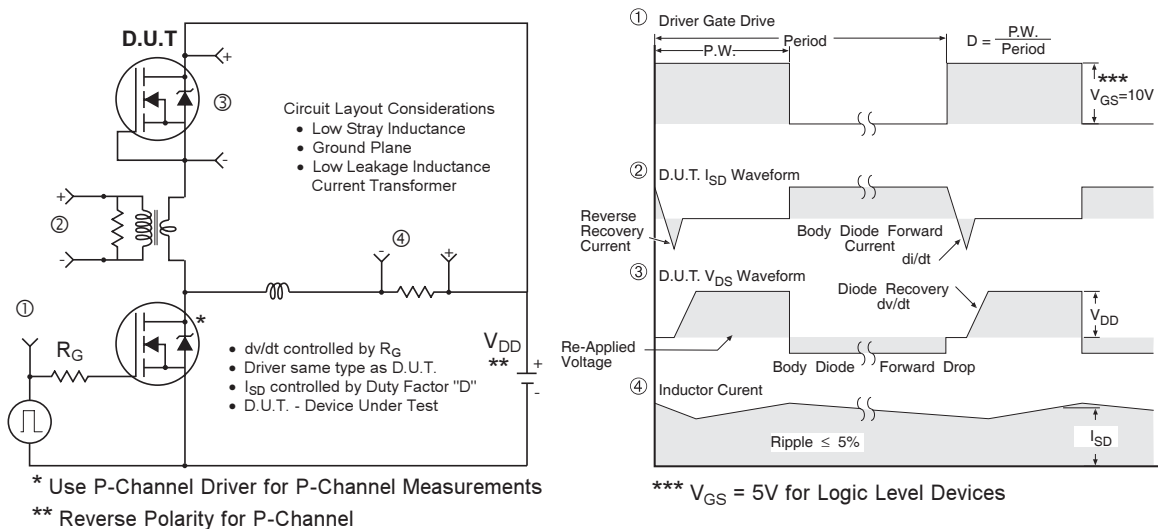
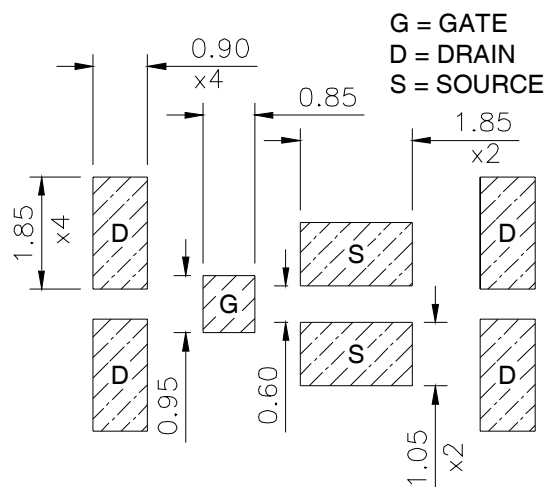
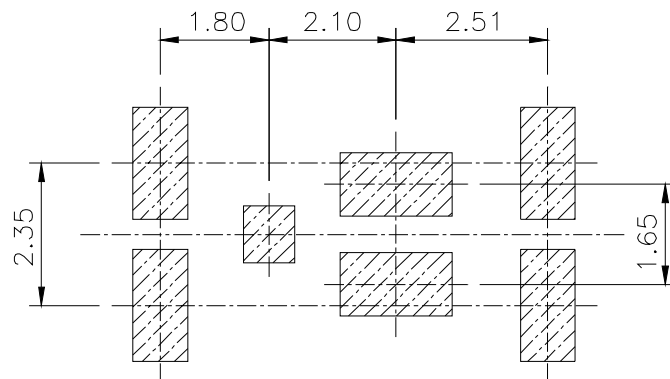


Fig 19. Diode Reverse Recovery Test Circuit for HEXFET® Power MOSFETs

DirectFET™ Board Footprint, MT Outline (Medium Size Can, T-Designation).

Please see DirectFET application note AN-1035 for all details regarding the assembly of DirectFET.

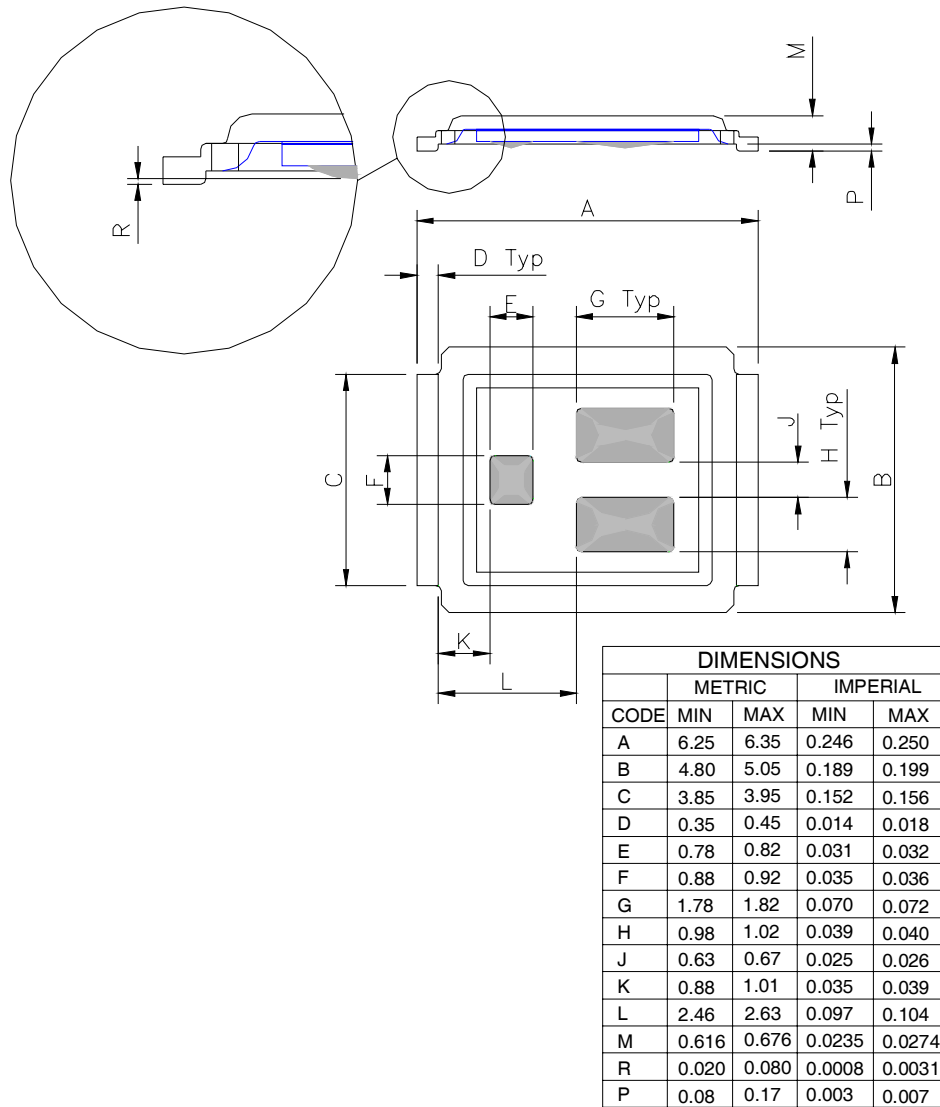
This includes all recommendations for stencil and substrate designs.



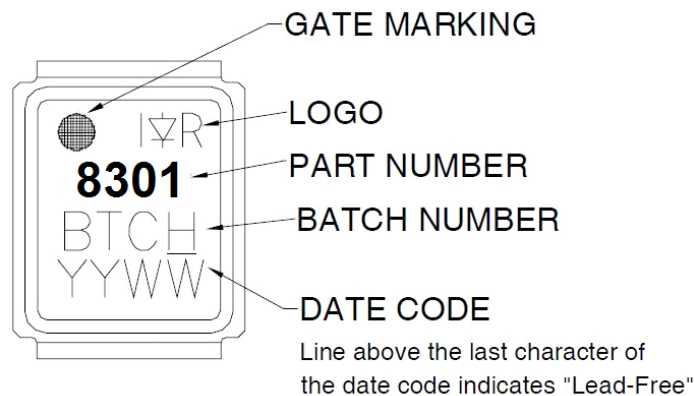
Note: For the most current drawing please refer to IR website at <http://www.irf.com/package/>

DirectFET™ Outline Dimension, MT Outline (Medium Size Can, T-Designation).

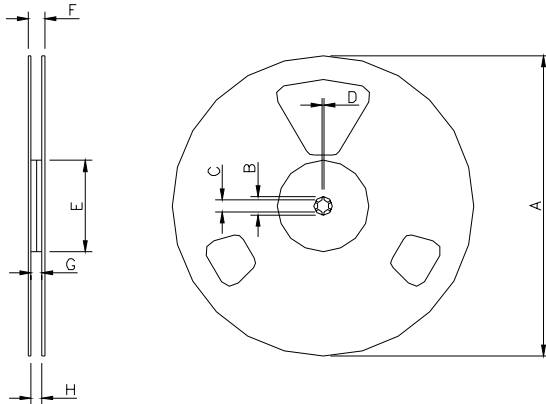
Please see DirectFET application note AN-1035 for all details regarding the assembly of DirectFET. This includes all recommendations for stencil and substrate designs.



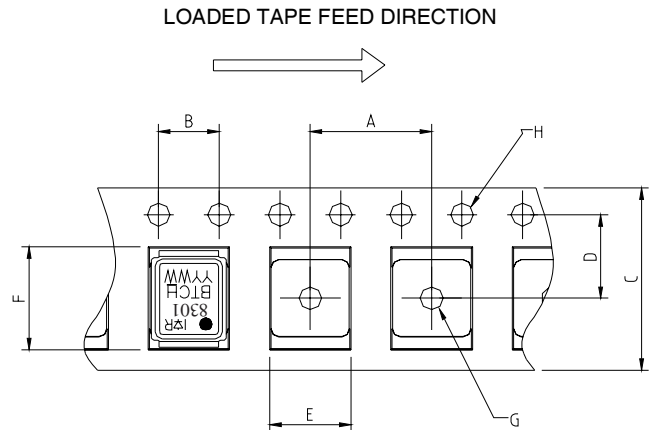
DirectFET™ Part Marking



Note: For the most current drawing please refer to IR website at <http://www.irf.com/package/>

DirectFET™ Tape & Reel Dimension (Showing component orientation).


NOTE: Controlling dimensions in mm
Std reel quantity is 4800 parts. (ordered as IRF8301MTRPbF).



NOTE: CONTROLLING DIMENSIONS IN MM

REEL DIMENSIONS				
STANDARD OPTION (QTY 4000)				
CODE	METRIC		IMPERIAL	
	MIN	MAX	MIN	MAX
A	330.0	N.C	12.992	N.C
B	20.2	N.C	0.795	N.C
C	12.8	13.2	0.504	0.520
D	1.5	N.C	0.059	N.C
E	100.0	N.C	3.937	N.C
F	N.C	18.4	N.C	0.724
G	12.4	14.4	0.488	0.567
H	11.9	15.4	0.469	0.606

DIMENSIONS				
CODE	METRIC		IMPERIAL	
	MIN	MAX	MIN	MAX
A	7.90	8.10	0.311	0.319
B	3.90	4.10	0.154	0.161
C	11.90	12.30	0.469	0.484
D	5.45	5.55	0.215	0.219
E	5.10	5.30	0.201	0.209
F	6.50	6.70	0.256	0.264
G	1.50	N.C	0.059	N.C
H	1.50	1.60	0.059	0.063

Note: For the most current drawing please refer to IR website at <http://www.irf.com/package/>

Revision History

Date	Comments
09/05/2013	• Added the StrongIRFET logo on the top of the part number, on page 1.

IMPORTANT NOTICE

The information given in this document shall in no event be regarded as a guarantee of conditions or characteristics ("Beschaffheitsgarantie").

With respect to any examples, hints or any typical values stated herein and/or any information regarding the application of the product, Infineon Technologies hereby disclaims any and all warranties and liabilities of any kind, including without limitation warranties of non-infringement of intellectual property rights of any third party.

In addition, any information given in this document is subject to customer's compliance with its obligations stated in this document and any applicable legal requirements, norms and standards concerning customer's products and any use of the product of Infineon Technologies in customer's applications.

The data contained in this document is exclusively intended for technically trained staff. It is the responsibility of customer's technical departments to evaluate the suitability of the product for the intended application and the completeness of the product information given in this document with respect to such application.

For further information on the product, technology, delivery terms and conditions and prices please contact your nearest Infineon Technologies office (www.infineon.com).

WARNINGS

Due to technical requirements products may contain dangerous substances. For information on the types in question please contact your nearest Infineon Technologies office.

Except as otherwise explicitly approved by Infineon Technologies in a written document signed by authorized representatives of Infineon Technologies, Infineon Technologies' products may not be used in any applications where a failure of the product or any consequences of the use thereof can reasonably be expected to result in personal injury.

Mouser Electronics

Authorized Distributor

Click to View Pricing, Inventory, Delivery & Lifecycle Information:

[Infineon:](#)

[IRF8301MTRPBF](#)