

SPECIFICATION

产品规格书

NO.(编号) : NCYM-DS-RD

Part No.(型号) : 5050A24-XXH165-U8S1P-V20-LX

Description(描述) : 5050 White LED

Model(说明) : EMC5050 24V CRI 80

CUSTOMER APPEROVED (客户审核)	APPROVED (核准)	ISSUED (制定)
	朱磊	王磊

SHINEON (NANCHANG) TECHNOLOGY CO.,LTD

699 Tianxiang Avenue, Building 7-1, CEC Low-Carbon Technology Park, High-Tech
Development District, Nanchang City, Jiangxi Province, P.R.China
TEL: 0791-88130119
<http://www.shineon.cn>

5050A24-XXH165-U8S1P-V20-LX Datasheet

This 5050 LED Light Source is a high performance energy efficient device which can handle high thermal and high driving current. The small package outline and high intensity make it an ideal choice for High Bay, tunnel lamp, street lamp outdoor light and etc.

The White Power LED is available in the range of color temperature from 2700K to 6500K.

This part has a foot print that is compatible to most of the same size LED in the market today.

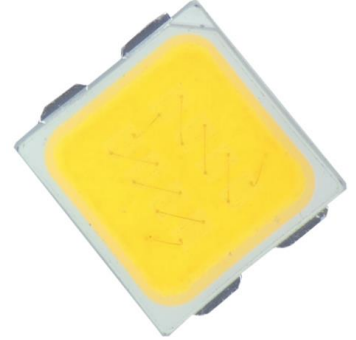

FEATURES

- Available in Cool White, Neutral White and Warm White color
- ANSI-compatible chromaticity bins
- High luminous Intensity and high efficiency
- Compatible with reflow soldering process
- Low thermal resistance
- Long operation life
- Wide viewing angle at 120°
- EMC package
- Environmental friendly, RoHS compliance

APPLICATIONS

- Street lighting
- Par lighting
- Outdoor lighting

Note: The information in this document is subject to change without notice.

PACKAGE DIMENSIONS

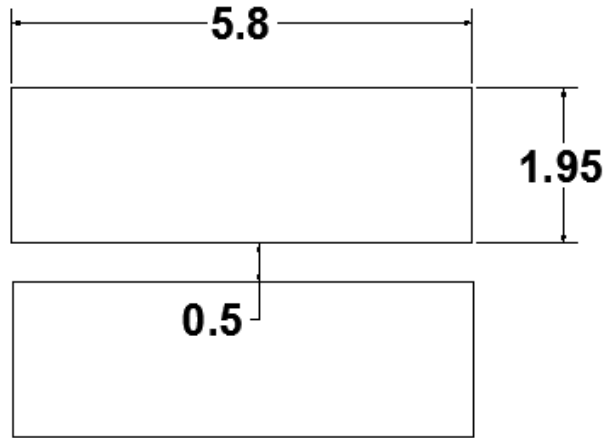
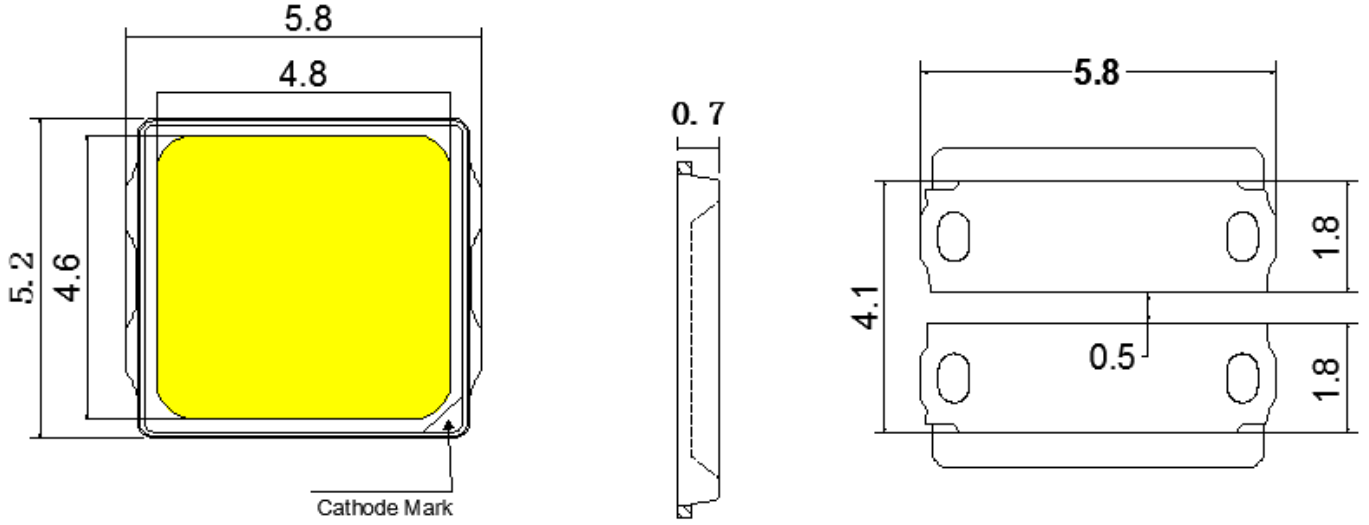

Recommended PCB Soldering Pad Pattern

Notes/ 注:

1. All dimensions in millimeters.
2. Thickness tolerance of copper plate is $\pm 0.02\text{mm}$.
3. Thickness tolerance of product is $\pm 0.05\text{mm}$.
4. Tolerance is $\pm 0.1\text{mm}$ unless otherwise noted.

ABSOLUTE MAXIMUM RATINGS ((T_j=25°C; CRI70 ; CCT4000K)

Parameter	Symbol	Value	Unit
Forward current	IF	240	mA
Peak Forward Current	IFP	300	mA
Reverse Voltage	VR	10	V
Operating Temperature	Topr	-40~+85	°C
Storage Temperature	Tstg	-40~+100	°C
Soldering Temperature	Tsld	Reflow Soldering: 260°C for 10 seconds	
LED Junction Temperature	Tj	125	°C

ELECTRO-OPTICAL CHARACTERISTICS (T_j=25°C)

Parameter	Symbol	Forward Current	Min	Typ	Max	Unit
Forward Voltage	V _F	IF=165mA	22	--	26	V
Viewing Angle	2θ _{1/2}	IF=165mA	--	120	--	deg.
Luminous Flux	Φ _v	IF=165mA	600	--	740	lm
Color Rendering Index	CRI	IF=165mA	80	--	--	--
Color Temperature	CCT	IF=165mA	2600	--	7000	K
Thermal Resistance	R _{th-js}	IF=165mA	--	3	--	°C/W

Notes 注:

- Luminous flux is measured with an accuracy of ± 5%.
- Chromaticity coordinate bins are measured with an accuracy of ± 0.01.
- CRI is measured with an accuracy of ± 2.
- Some color and CRI bins may have limited availability, please contact us before ordering.
- All measurements were made under the standardized environment of Shineon

RELATIVE SPECTRAL POWER DISTRIBUTION ($T_j=25^{\circ}\text{C}$)

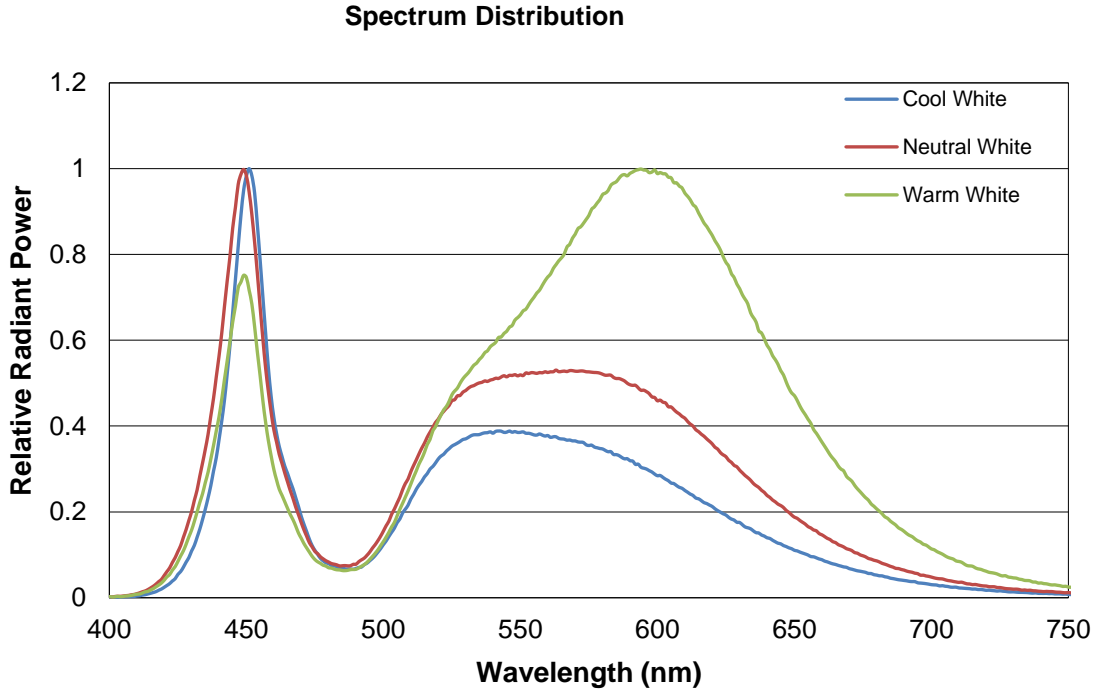

TYPICAL SPATIAL DISTRIBUTION

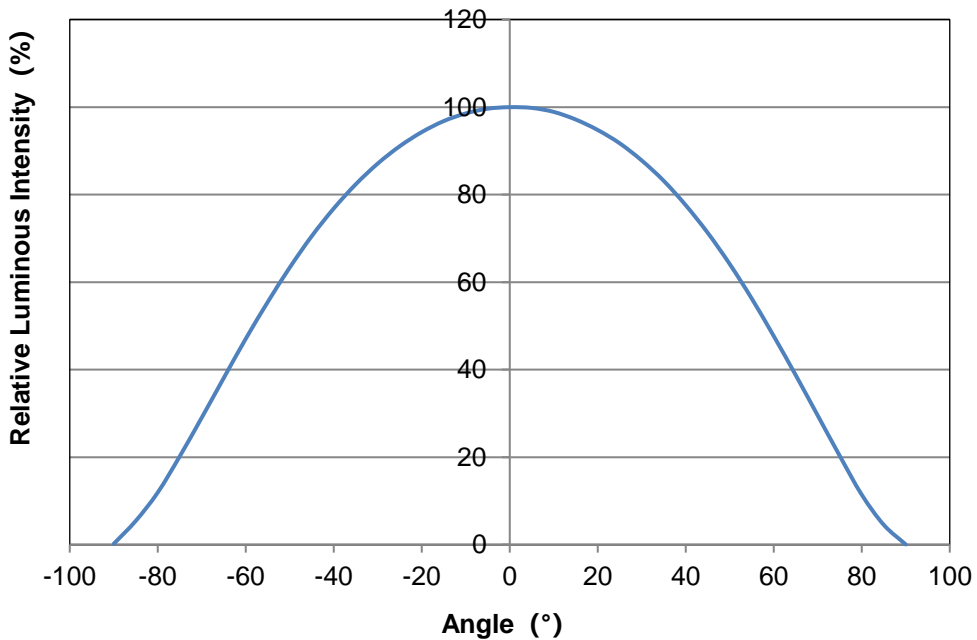

RELATIVE LUMINOUS FLUX VS. CURRENT ($T_j=25^{\circ}\text{C}$)

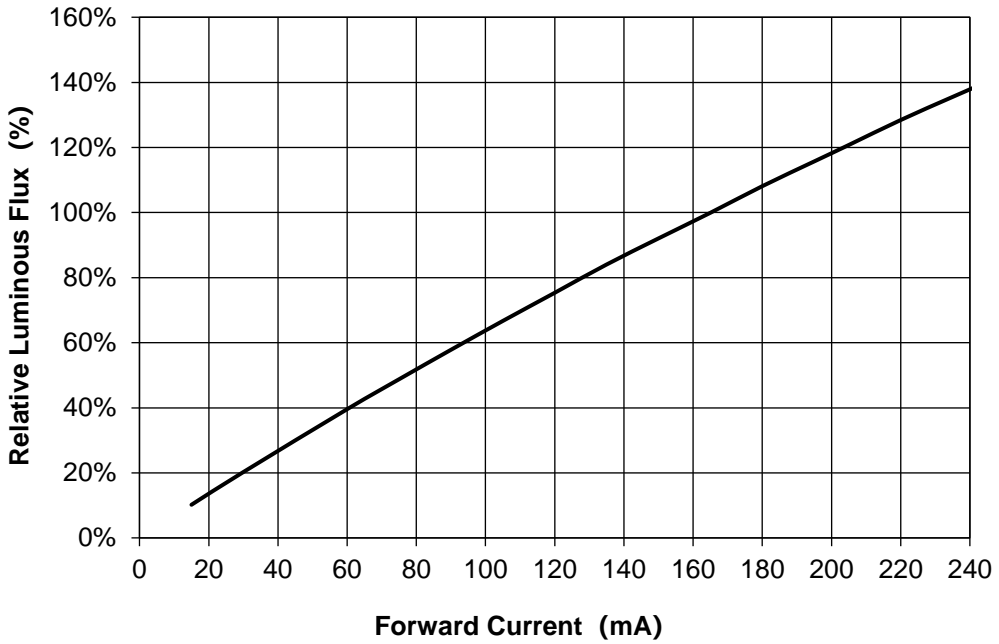

ELECTRICAL CHARACTERISTICS ($T_j=25^{\circ}\text{C}$)

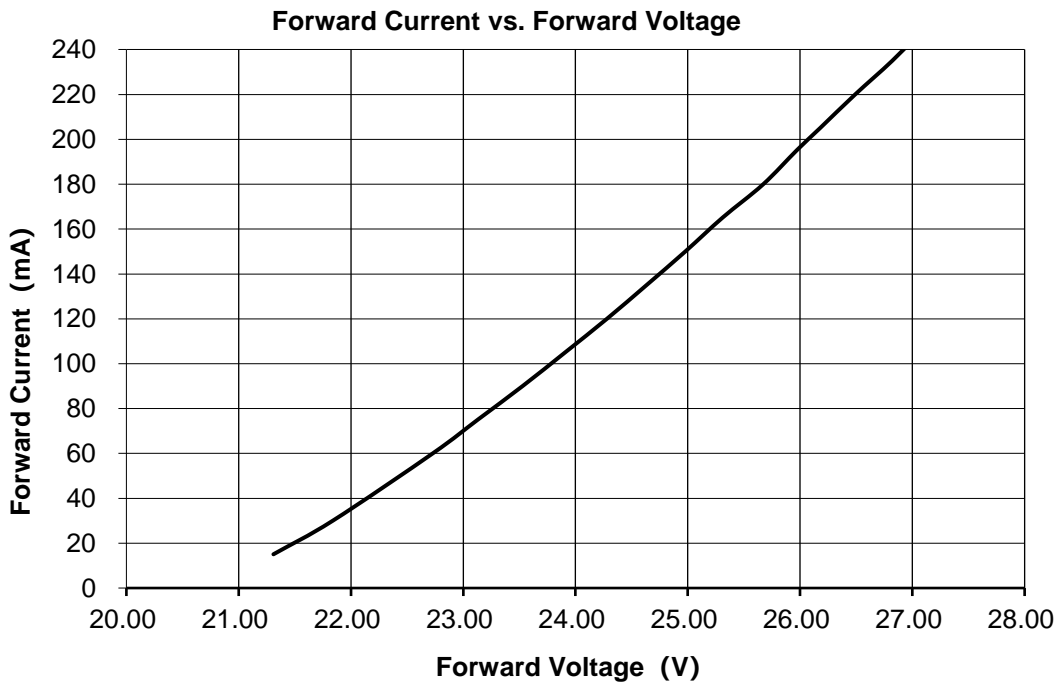

MAXIMUM CURRENT VS. AMBIENT TEMPERATURE

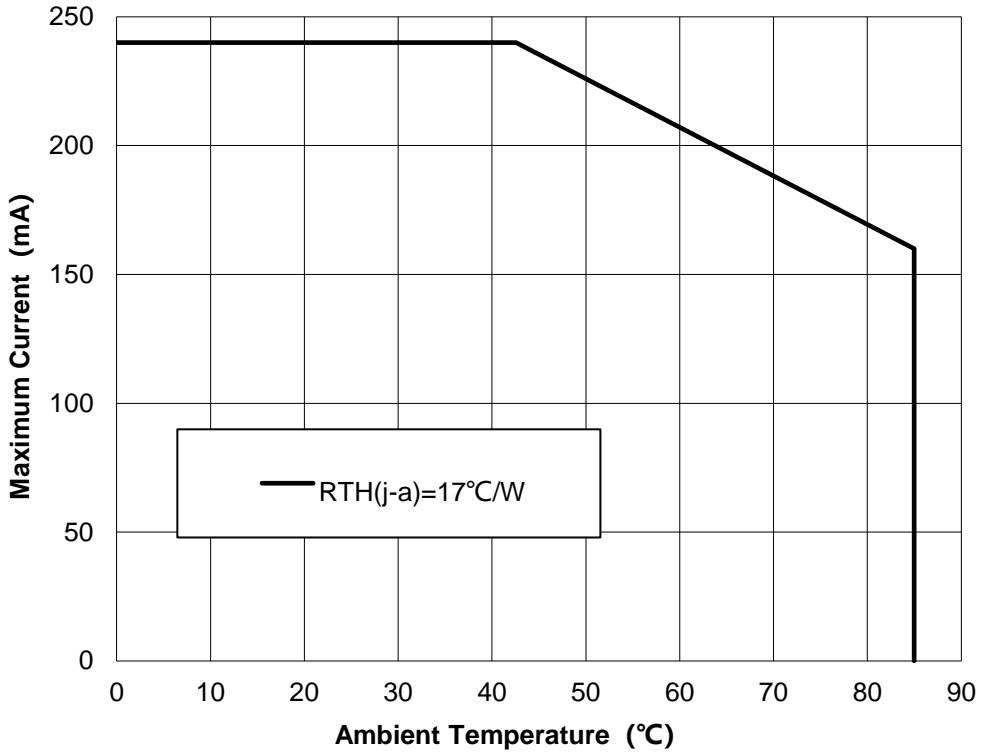

RELATIVE RADIANT FLUX VS. JUNCTION TEMPERATURE

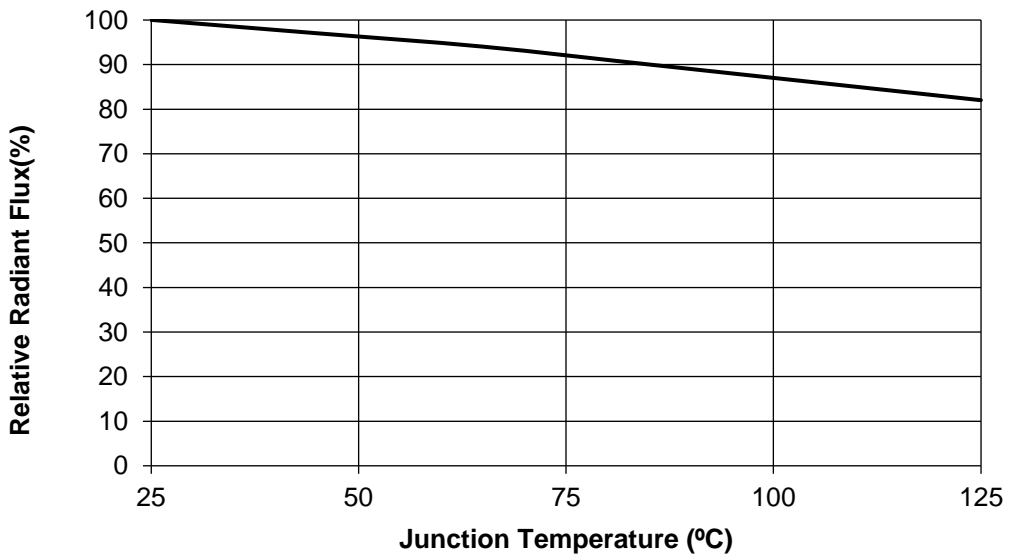

SORTING RANKS
(1) Luminous Flux (T_j=25°C)

Part Number	Condition	Rank	Unit
5050A24-27H165-U8S1P-V20-LX	165mA	V0	lm
		600-650	
5050A24-30H165-U8S1P-V20-LX		V3	
		650-700	
5050A24-40H165-U8S1P-V20-LX		V4	
		690-740	
5050A24-50H165-U8S1P-V20-LX		V4	
		690-740	
5050A24-57H165-U8S1P-V20-LX		V4	
		690-740	
5050A24-65H165-U8S1P-V20-LX	V2		
	680-730		

(2) Forward Voltage (T_j=25°C)

Rank	Condition	Min.	Max.	Unit
HB	165mA	22	24	V
HC		24	26	

Notes 注：

- 5% tolerance for luminous intensity may be caused by measurement inaccuracy.
- Measurement Uncertainty of the Forward Voltage : ± 0.1

(3) Chromaticity Bins

Part Number	5050A24-27H165-U8S1P-V20-LX			CCT	2700K
Bin Code	Color Coordinates (x,y)				
A27-5	x	y	a	b	Theta°
	0.4578	0.4101	0.01290	0.00685	53.17

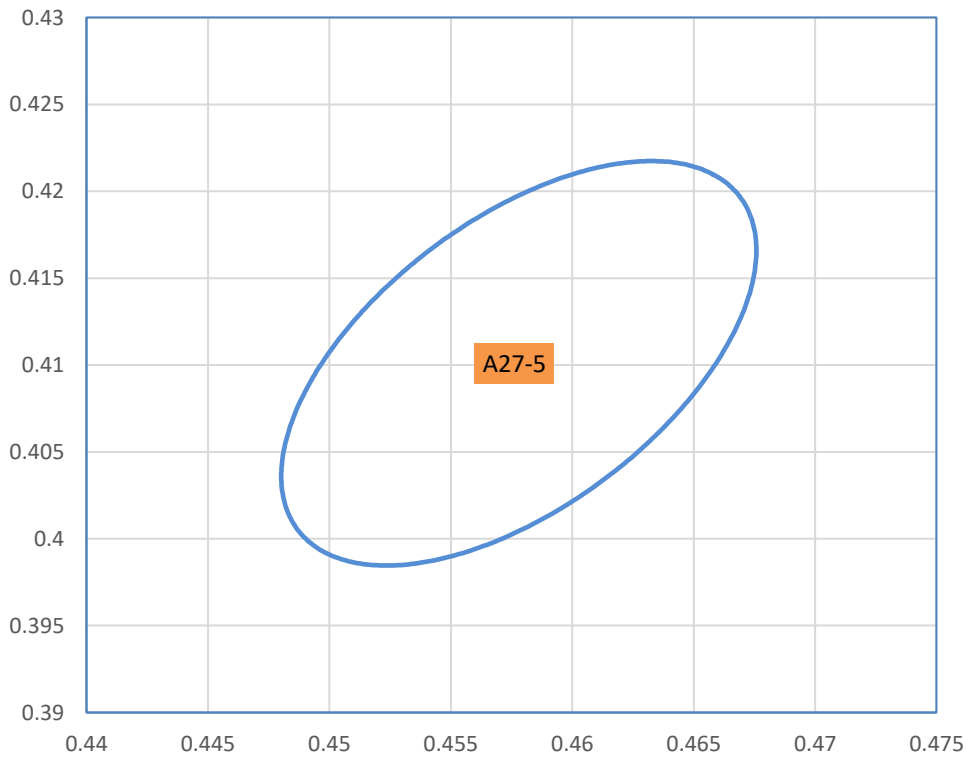

Part Number	5050A24-30H165-U8S1P-V20-LX			CCT	3000K
Bin Code	Color Coordinates (x,y)				
A30-5	x	y	a	b	Theta°
	0.4338	0.403	0.01390	0.00680	53.2167

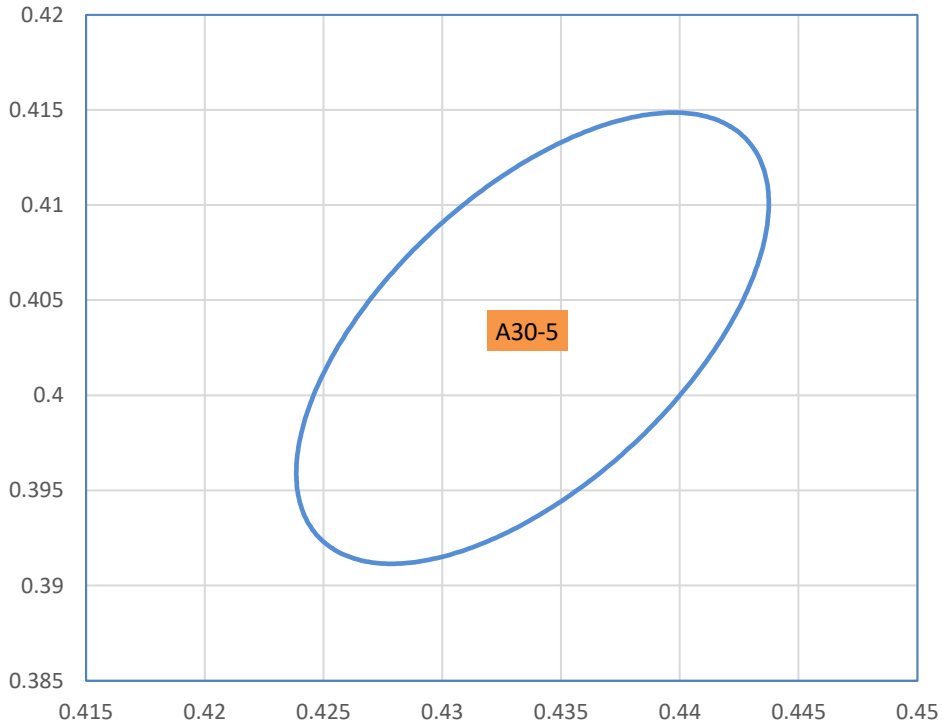

Part Number	5050A24-40H165-U8S1P-V20-LX	CCT	4000K		
Bin Code	Color Coordinates (x,y)				
A40-5	x	y	a	b	Theta°
	0.3818	0.3797	0.01565	0.00670	53.717

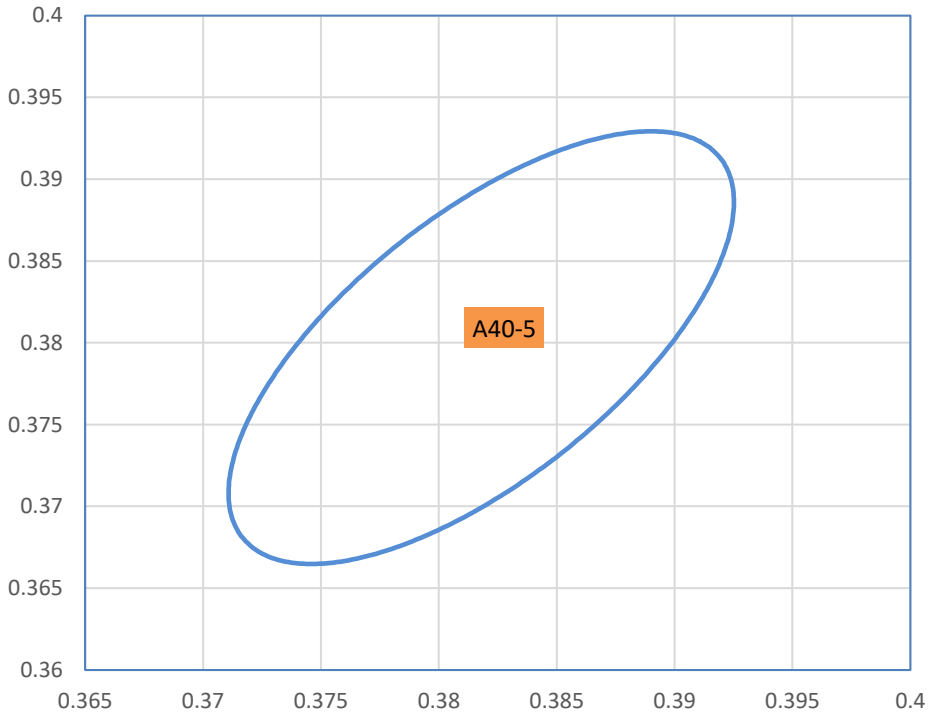

Part Number	5050A24-50H165-U8S1P-V20-LX			CCT	5000K
Bin Code	Color Coordinates (x,y)				
A50-5	x	y	a	b	Theta°
	0.3447	0.3553	0.01370	0.00590	59.617

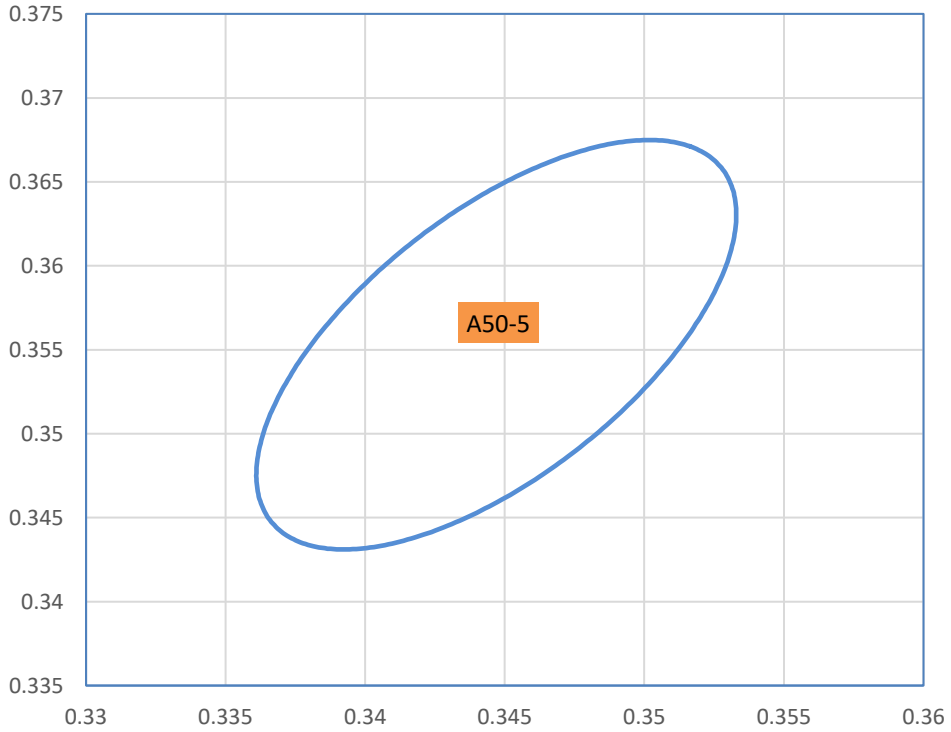

Part Number	5050A24-57H165-U8S1P-V20-LX			CCT	5700K
Bin Code	Color Coordinates 色坐标(x,y)				
A57-5	x	y	a	b	Theta°
	0.3287	0.3417	0.01245	0.00535	59.128

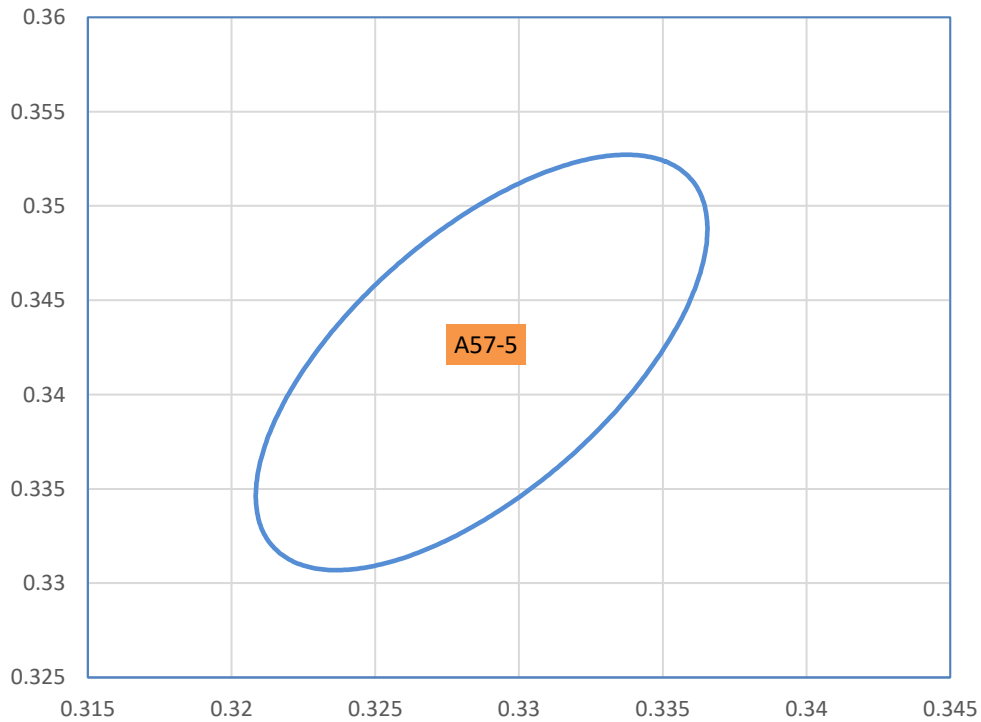

Part Number	5050A24-60H165-U8S1P-V20-LX	CCT	6000K		
Bin Code	Color Coordinates (x,y)				
A60-5	x	y	a	b	Theta°
	0.322	0.3365	0.01179	0.00504	59.21

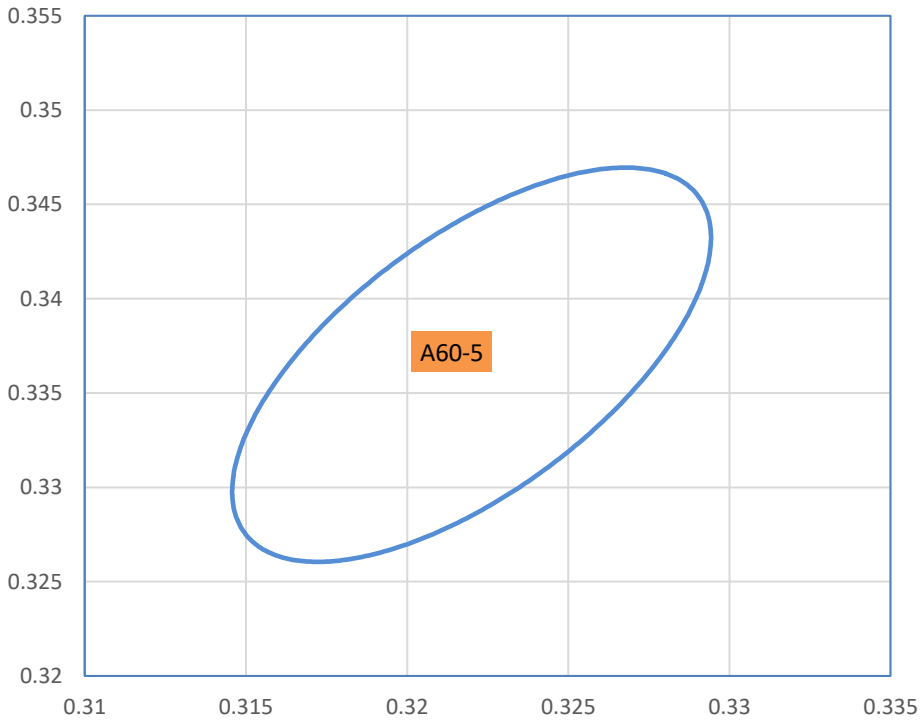

Part Number 品名	5050A24-65H165-U8S1P-V20-LX			CCT 色温	6500K
Bin Code 等级代码	Color Coordinates 色坐标(x,y)				
A65-5	x	y	a	b	Theta°
	0.3123	0.3282	0.01115	0.00475	58.5667

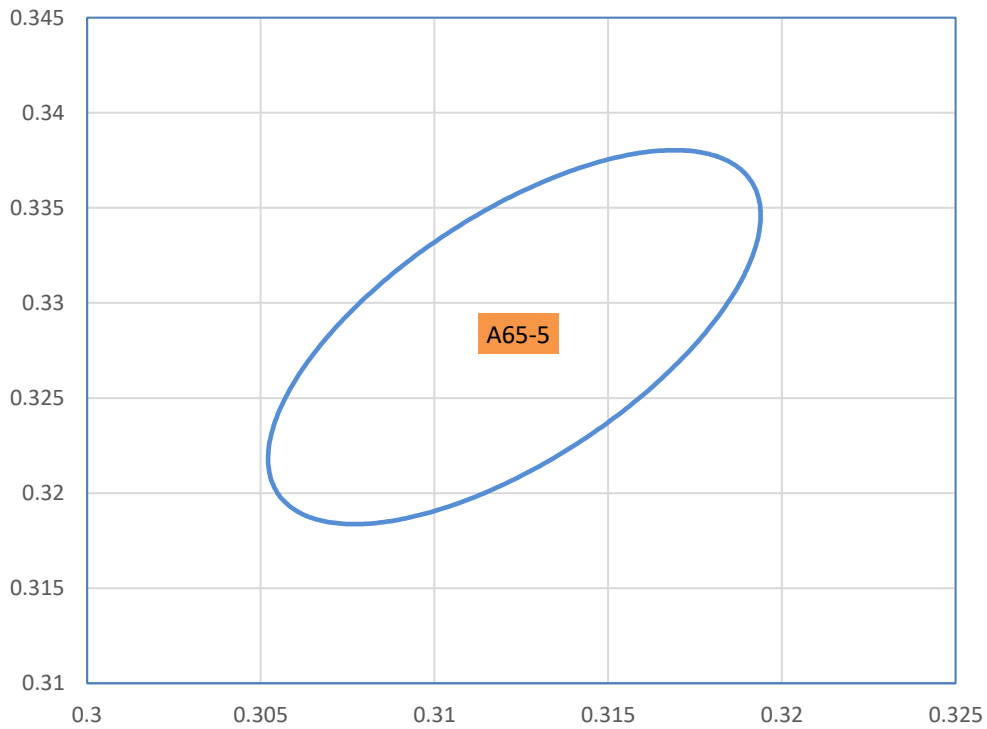

TAPE AND REEL

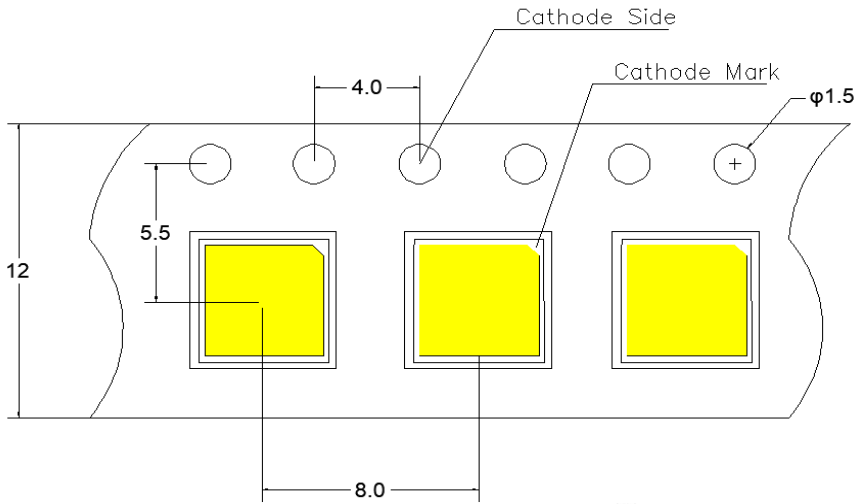

Small reel

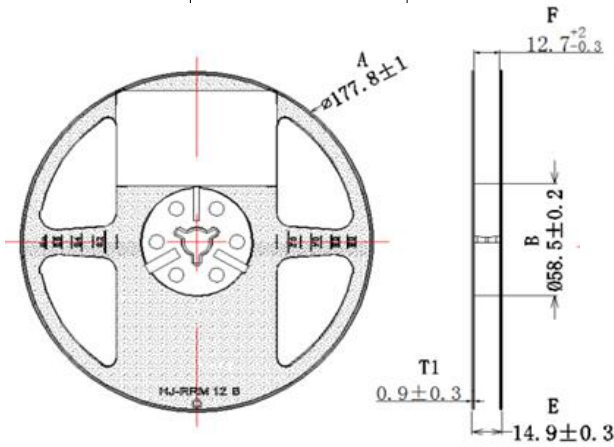

Big reel

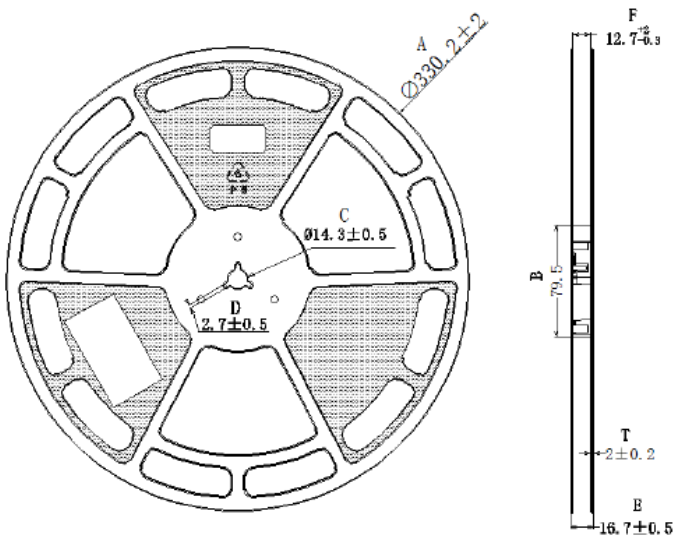

Notes:

- (1) Quantity : 1500pcs/Reel OR 5,000pcs/Reel
- (2) Cumulative Tolerance : Cumulative Tolerance/10 pitches to be $\pm 0.2\text{mm}$
- (3) Adhesion Strength of Cover Tape : Adhesion strength to be 0.1-0.7N when the cover tape is turned off from the carrier tape at the angle of 10° to the carrier tape
- (4) Package : P/N, Manufacturing data Code No. and quantity to be indicated on a damp proof Package.

PACKAGING

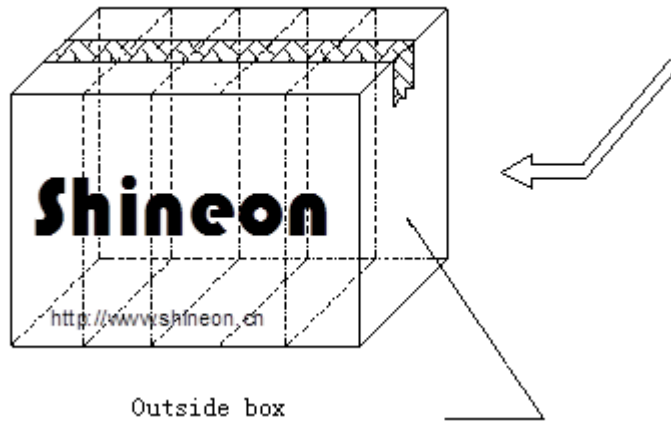
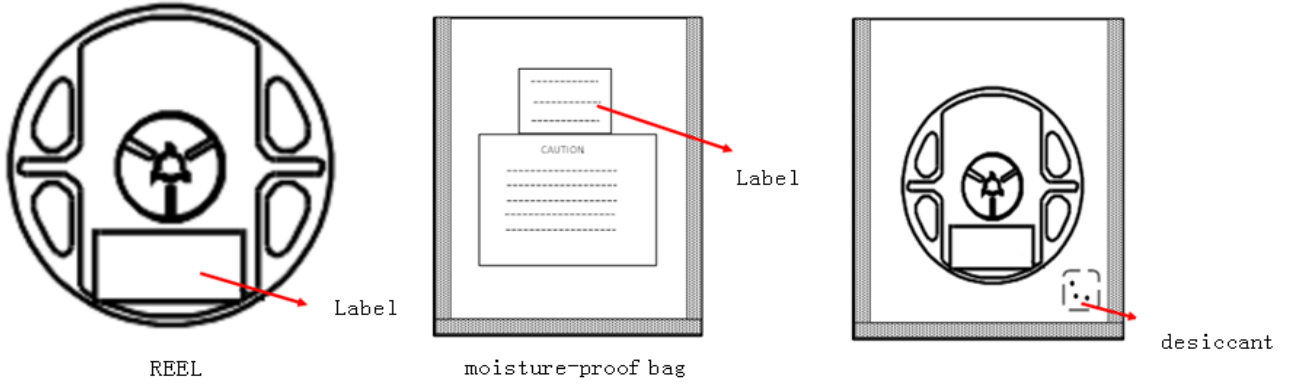

Notes:

- (1) Box size: 33x25x42cm 60K/Box 1500pcs/Reel
- (2) Box size: 38x36x42cm 80K/Box 5000pcs/Reel,

REFLOW SOLDERING CHARACTERISTICS

For Reflow Process :

Preheating 预热 : 140°C~160°C±5°C, within 2 minutes.

Operation heating 作业加热 : 260°C(Max.) within 10 seconds.(Max)

Gradual Cooling (Avoid quenching).

Lead solder		Lead-free solder	
Pre-heat	120-150°C	Pre-heat	150-200°C
Pre-heat time	120 sec.Max.	Pre-heat time	120 sec.Max.
Peak Temperature	240°C Max.	Peak Temperature	260°C Max.
Soldering time condition	10 sec.Max.	Soldering time condition	10 sec.Max.

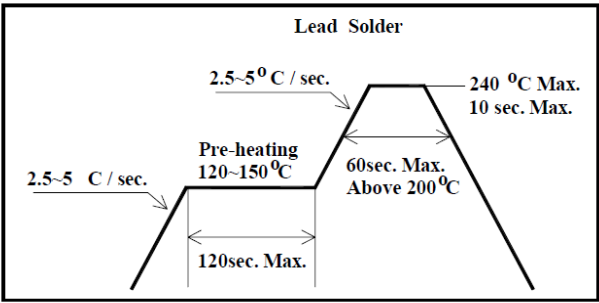
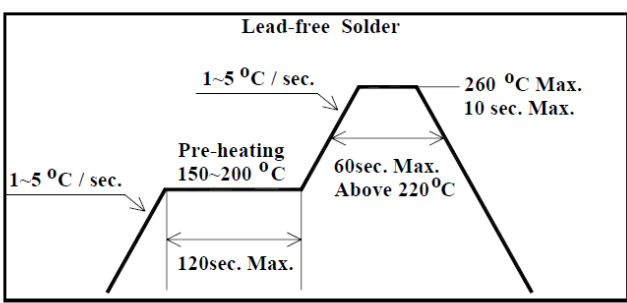
Lead Solder	Lead-free Solder
	

Notes:

The encapsulated material of the LEDs is silicone . Therefore the LEDs have a soft surface on the top of package. The pressure to the top surface will be influence to the reliability of the LEDs. Precautions should be taken to avoid the strong pressure on the encapsulated part. So when using the picking up nozzle, the pressure on the silicone resin should be proper.

Reliability Test Items

Test Items	Test Duration	Number of Damaged
Steady State Operating Life of High Temperature (HTOL) $T_s=85^{\circ}\text{C}$, $I_F=\text{Max}$	1000hrs	0/20
Steady State Operating Life of Low Temperature (LTOL) $T_a=-40^{\circ}\text{C}$, $I_F=\text{Max}$	1000hrs	0/20
High Temperature Storage (HTS)	1000hrs	0/20
Low Temperature Storage (LTS)	1000hrs	0/20
Thermal Shock (TS) $-45^{\circ}\text{C}\sim 125^{\circ}\text{C}$ 15min dwell 30sec transfer	100cycles	0/20
Solder Resistance (SR) 265°C , 3X MSL	5sec	0/20
Solder Ability (SA) 245°C 5sec, 95% coverage	5sec	0/11

Item 项目	Symbol	Test Condition	Criteria for Judgment	
			Min.	Max.
Forward Voltage	V_f	$I_F=\text{Typical Current}$		U.S.L x1.1
Luminous Flux	I_m	$I_F=\text{Typical Current}$	L.S.L x0.7	
CCX&CCY	x,y	$I_F=\text{Typical Current}$		Shift<0.02

PRECAUTION FOR USE

- (1) This device should not be used in any type of fluid such as water, oil, organic solvent, etc. When washing is required, IPA should be used.
 - (2) When the LEDs are illuminating, operating current should be decided after considering the ambient maximum temperature.
- (3) LEDs must be stored to maintain a clean atmosphere. If the LEDs are stored for 3 months or more after being shipped from ShineOn, a sealed container with a nitrogen atmosphere should be used for storage.
- (4) The LEDs must be used within seven days after opening the moisture proof packing. Repack unused Products with anti-moisture packing, fold to close any opening and then store in a dry place.
- (5) The appearance and specifications of the product may be modified for improvement without notice.
- (6) This LED is sensitive to the static electricity and surge. It is recommended to use a wrist Band or anti-electrostatic glove when handling the LEDs.
- (7) On manual soldering, a solder tip must be needed as grounded for usage. If over voltage which exceeds the absolute maximum rating is applied to LEDs, it will cause damage LEDs and result in destruction. Damaged LEDs will show some unusual characteristics such as leak current remarkably increase ,turn-on voltage becomes lower and the LEDs get unlighted at low current.