



Features & Application

- ◆ High lighting efficiency
- ◆ Optimized for uniform effects
- ◆ Roadway Lighting
- ◆ Glare Free
- ◆ Extremely luminous flux
- ◆ Soft wide beam with good illuminance uniformity
- ◆ Easy fixing system to the PCB
- ◆ Complying with UL94 Specifications
- ◆ UV protected

Table of Contents

- ◆ General information & Product Nomenclature.....P.2
- ◆ Material specificationP.3
- ◆ Optical specificationP.3
- ◆ Mechanical specificationP.4

GENERAL INFORMATION

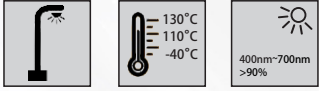

- ◆ Type II Lens for Street Light Application.
- ◆ Operating Temperature range $-40^{\circ}\text{C} \sim +110^{\circ}\text{C}$ (upper limit $+130^{\circ}\text{C}$)
- ◆ Storage Temperature range $-40^{\circ}\text{C} \sim +110^{\circ}\text{C}$ (upper limit $+130^{\circ}\text{C}$)
- ◆ Average transmittance in visible spectrum $400\text{nm} \sim 700\text{nm} > 90\%$

PRODUCT NOMENCLATURE

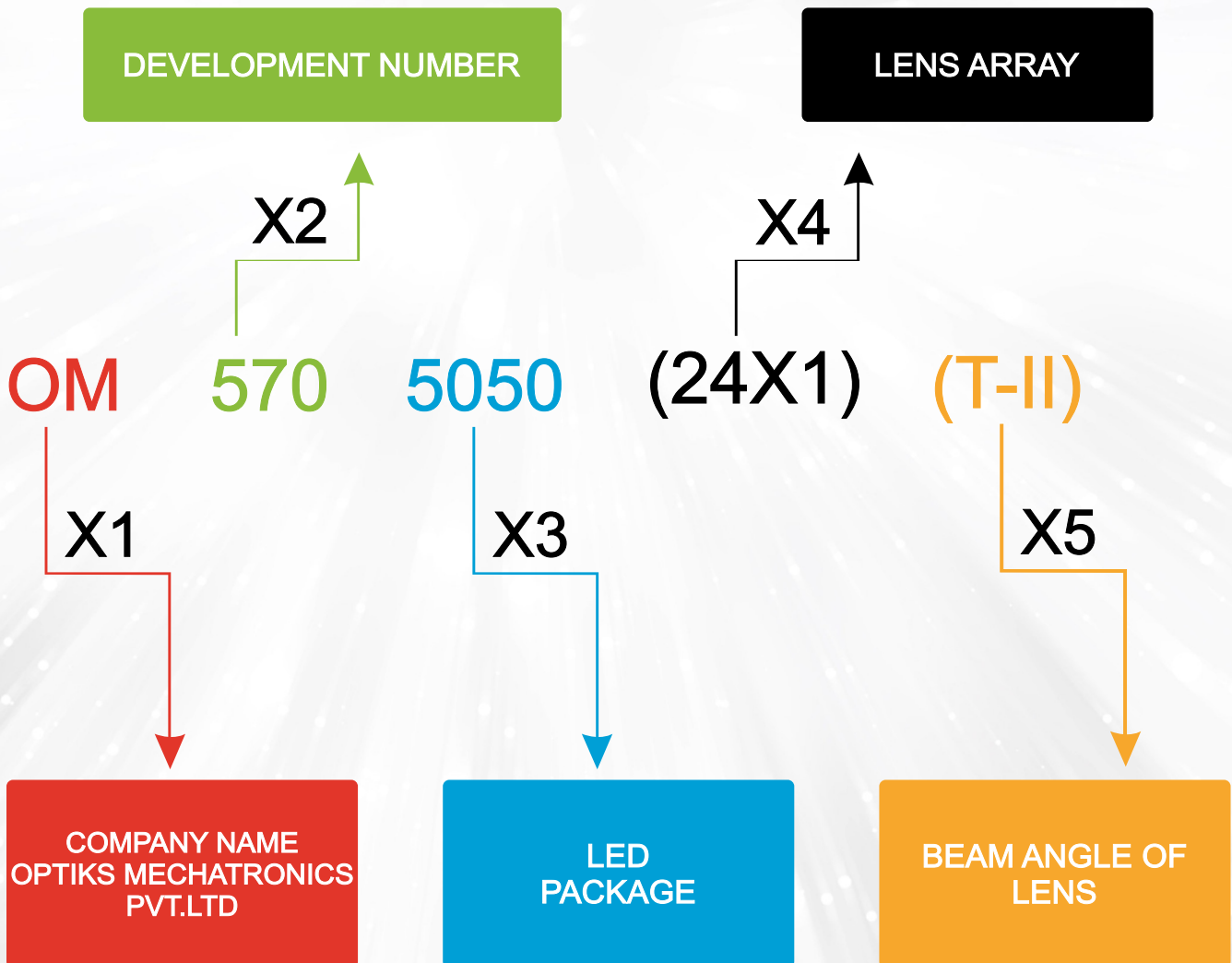

MATERIAL SPECIFICATION



- ◆ Lens Material : Optical Grade PC (Bayer 2407)
- ◆ Luminous transmittance : 89 to 90% (ISO 13468-2/ASTM D1003)
- ◆ Refractive index : 1.584 (ISO 489/ASTM D542)
- ◆ Flammability : HB/V-0 (UI94)
- ◆ Colour : Clear

OPTICAL SPECIFICATION

Note: (1) All the results of analysis are based on 0 degrees of elevation.
(2) Tolerance: $\pm 10\%$.

Beam Angle

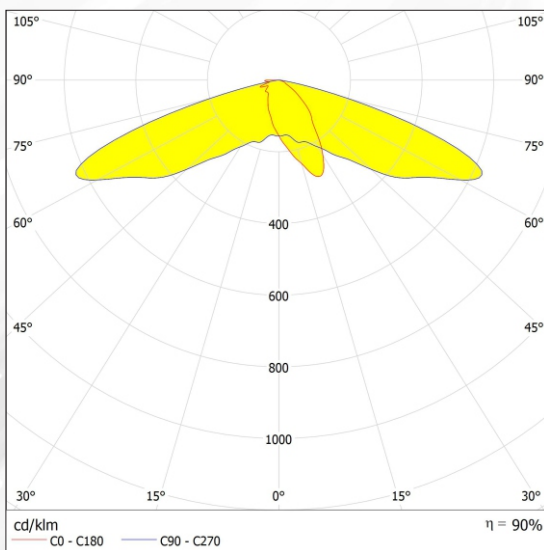

Beam Pattern

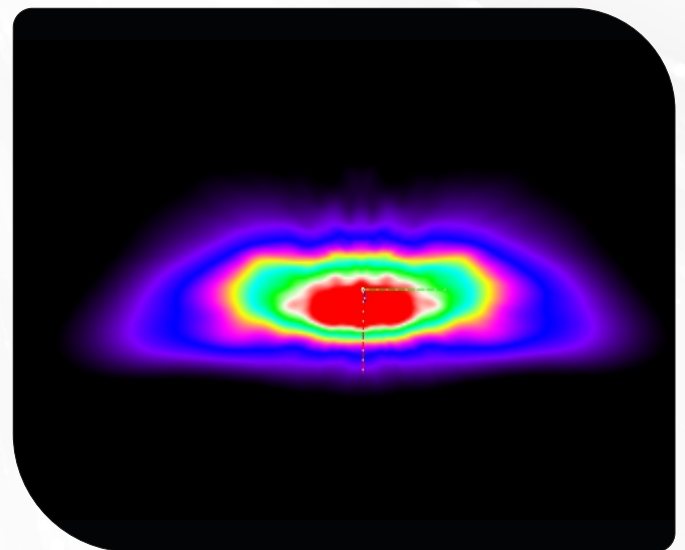

MECHANICAL SPECIFICATION

Note:

1. Unit measurement: mm
2. General tolerance: $\pm 0.2\text{mm}$
3. Protruding of the gate from the side surface: less than 0.3mm

FASTENING

Glue

Screw

Tape

Fixing-ring

Frame

LENS DIMENSION

LED+LENS ASSEMBLY INSTRUCTION

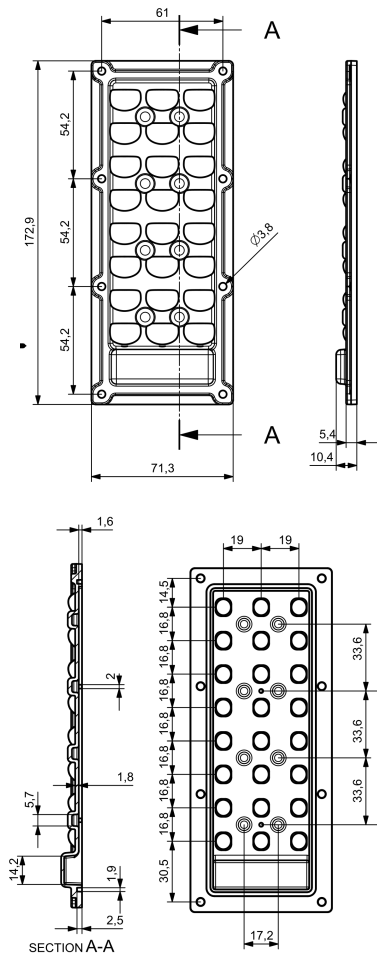

USAGE AND MAINTENANCE



1. If necessary, clean lenses with mild soap, water and soft cloth.
2. Never use any commercial cleaning solvents on lenses, like alcohol.
3. Please handle or install lenses with wearing gloves, skin oils may damage lens or its optical characteristic.