



MAX6653 Evaluation System/Evaluation Kit

General Description

The MAX6653 evaluation system (EV system) consists of a MAX6653 evaluation kit (EV kit) and a companion Maxim system management bus (SMBus) interface board.

The MAX6653 EV kit is an assembled and tested PC board that demonstrates the MAX6653 local/remote temperature sensor and fan-speed regulator. It monitors the junction temperature of an internal and external diode-connected transistor, and converts the temperature to 11-bit, 2-wire serial data. A 2N3906 temperature-sensor transistor comes soldered to the board in a SOT23 package, but it can be removed. The board can then be connected through a twisted pair to a remote diode close to your system.

The MAX6653 also incorporates a closed-loop fan controller that regulates fan speed with either an analog or digital tachometer feedback. **Note:** Use this EV kit data sheet in conjunction with the MAX6653/MAX6663/MAX6664 data sheet. The EV kit also includes Windows® 98/2000/XP-compatible software, which provides a professional user interface for exercising the MAX6653's features. The program is menu driven and offers a graphical user interface (GUI) complete with control buttons and a status display.

The Maxim SMBus interface board (MAXSMBUS) allows an IBM-compatible PC to use its parallel port to emulate an SMBus 2-wire interface. Order the MAX6653EVSYS for a complete IBM PC-based evaluation of the MAX6653. Order the MAX6653EVKIT if you already have an SMBus interface.

Features

- ◆ Measures and Displays Local and Remote Sensor Temperatures
- ◆ Controls Fan Speed
- ◆ Programmable Alarms and Configuration
- ◆ On-Board Signal Monitor
- ◆ Operating Temperature Ranges
 - 40°C to +125°C (Remote Sensor)
 - 0°C to +70°C (Board)
- ◆ SMBus/I2C-Compatible 2-Wire Serial Interface
- ◆ Easy-to-Use Menu-Driven Software
- ◆ Completely Assembled and Tested
- ◆ Includes Windows 98/2000/XP-Compatible Software and Demo PC Board
- ◆ Also Evaluates MAX6663/MAX6664

Ordering Information

PART	TEMP RANGE	IC PACKAGE	SMBus INTERFACE TYPE
MAX6653EVKIT	0°C to +70°C	16 QSOP	Not included
MAX6653EVSYS	0°C to +70°C	16 QSOP	MAXSMBUS

Note: To evaluate the MAX6663/MAX6664, request a MAX6663AEE/MAX6664AEE free sample with the MAX6653EVKIT.

Note: The MAX6653 EV kit software is provided with the MAX6653EVKIT; however, the MAXSMBUS board is required to interface the EV kit to the computer when using the included software.

Component List

DESIGNATION	QTY	DESCRIPTION
C1, C2	2	1.0µF ±20%, 10V X5R ceramic capacitors (0603) TDK C1608X5R1A105M
C3	1	0.01µF ±20%, 25V X7R ceramic capacitor (0402) TDK C1005X7R1E103M
C4	1	2200pF ±20%, 50V X7R ceramic capacitor (0402) TDK C1005X7R1H222M
J1	1	2 x 10 right-angle female receptacle
J2	1	3-pin header

DESIGNATION	QTY	DESCRIPTION
JU1, JU2, JU8	0	Not installed
JU3, JU7	2	Jumpers, 2-pin headers
JU4, JU5, JU6, JU9	4	Jumpers, 3-pin headers
N1	1	N-channel 2.7A, 30V MOSFET (SOT23) Fairchild FDN359AN
Q1	1	PNP bipolar transistor (SOT23) Central Semiconductor CMPT3906 Diodes Inc. MMBT3906 Fairchild MMBT 3906

Windows is a registered trademark of Microsoft Corp.



For pricing, delivery, and ordering information, please contact Maxim/Dallas Direct! at 1-888-629-4642, or visit Maxim's website at www.maxim-ic.com.

MAX6653 Evaluation System/Evaluation Kit

Component List (continued)

DESIGNATION	QTY	DESCRIPTION
R1–R8	8	10k Ω \pm 5% resistors (0603)
R9	1	2 Ω \pm 5%, 1/2W resistor (2010) Vishay-Dale CRCW-2010-2R0-J IRC WCR2010-2R0-J
R10	1	1k Ω \pm 5% resistor (0603)
S1	1	Slide switch
U1	1	Maxim MAX6653AEE (16-pin QSOP)
U2	1	Maxim MAX1609EEE (16-pin QSOP)
None	6	Shunts
None	1	MAX6653 PC board
None	1	Software disk (CD ROM) MAX6653 evaluation kit

Quick Start

Recommended Equipment

- Computer running Windows 98, 2000, or XP
- Parallel printer port (This is a 25-pin socket on the back of the computer.)
- Standard 25-pin, straight-through, male-to-female cable (printer extension cable) to connect the computer's parallel port to the Maxim SMBus interface board
- 12V/100mA DC power supply
- 5V/50mA DC power supply
- 500mA DC power supply rated at 5V or 12V, depending on the fan
- 5V or 12V fan rated up to 250mA (with optional digital tachometer output)

Procedure

The MAX6653 EV kit is fully assembled and tested. Follow the steps below to verify board operation. **Do not turn on the power supplies until all connections are completed:**

- 1) Carefully connect the boards by aligning the 20-pin connector of the MAX6653 EV kit with the 20-pin header of the MAXSMBUS interface board. Gently press them together.
- 2) Make sure switch S1 is in the OFF position.
- 3) Ensure that a shunt is on pins 1-2 of jumpers JU6 and JU9.
- 4) Ensure that shunts are not installed on jumpers JU3, JU4, JU5, and JU7.
- 5) Connect a fan to either J2 or the FAN+, FAN-, and TACH/AIN pads. **Note:** If a fan without a digital tachometer is being used, install a shunt on jumper JU3 and remove resistor R10.
- 6) Connect a cable from the computer's parallel port to the SMBus interface board. Use a straight-through, 25-pin, female-to-male cable.
- 7) Use the INSTALL.EXE program on the provided CD ROM to copy the files and create icons in the Windows 98/2000/XP **Start** menu. **Do not turn on the power until all connections are made.**
- 8) Connect the 12V/100mA DC power supply to the pads labeled POS9 and GND1 of the SMBus interface board.
- 9) Connect the 5V/50mA DC power supply to the VCC and GND pads on the MAX6653 EV kit board.
- 10) Connect the fan power supply to the VFAN and GND pads.
- 11) Turn on the power supplies.
- 12) Turn on the EV kit by moving S1 to the ON position.
- 13) Start the MAX6653 program by opening its icon in the **Start** menu.
- 14) Observe as the program automatically detects the address of the MAX6653 and starts the main program. **Note:** The MAX6653 reads the address select pin at device power-up only.

Detailed Description of Software

User-Interface Panel

The user interface (shown in Figure 1) is easy to operate. Use the mouse, or press the Tab key to navigate with the arrow keys. Each of the buttons corresponds to bits in the command and configuration bytes. By clicking on them, the correct SMBus write operation is generated to update the internal registers of the MAX6653. The Interface box indicates the current **Device Type**, **Device Address**, **Register Address**, and the **Data Sent/Received**, for the last read/write operation. This data is used to confirm proper device operation. Device and manufacturer ID numbers are also shown.

The MAX6653 EV kit software splits and groups the functions of the MAX6653 into three separate categories: **Temperature**, **Fan Control**, and **Configuration/Status**. These functions can be accessed by selecting the appropriate tab at the top left of the MAX6653 EV kit software main window.

The device status registers (refer to the MAX6653/MAX6663/MAX6664 data sheet for status register information) are displayed in the Device Status panel at the

MAX6653 Evaluation System/Evaluation Kit

Evaluates: MAX6653/MAX6663/MAX6664

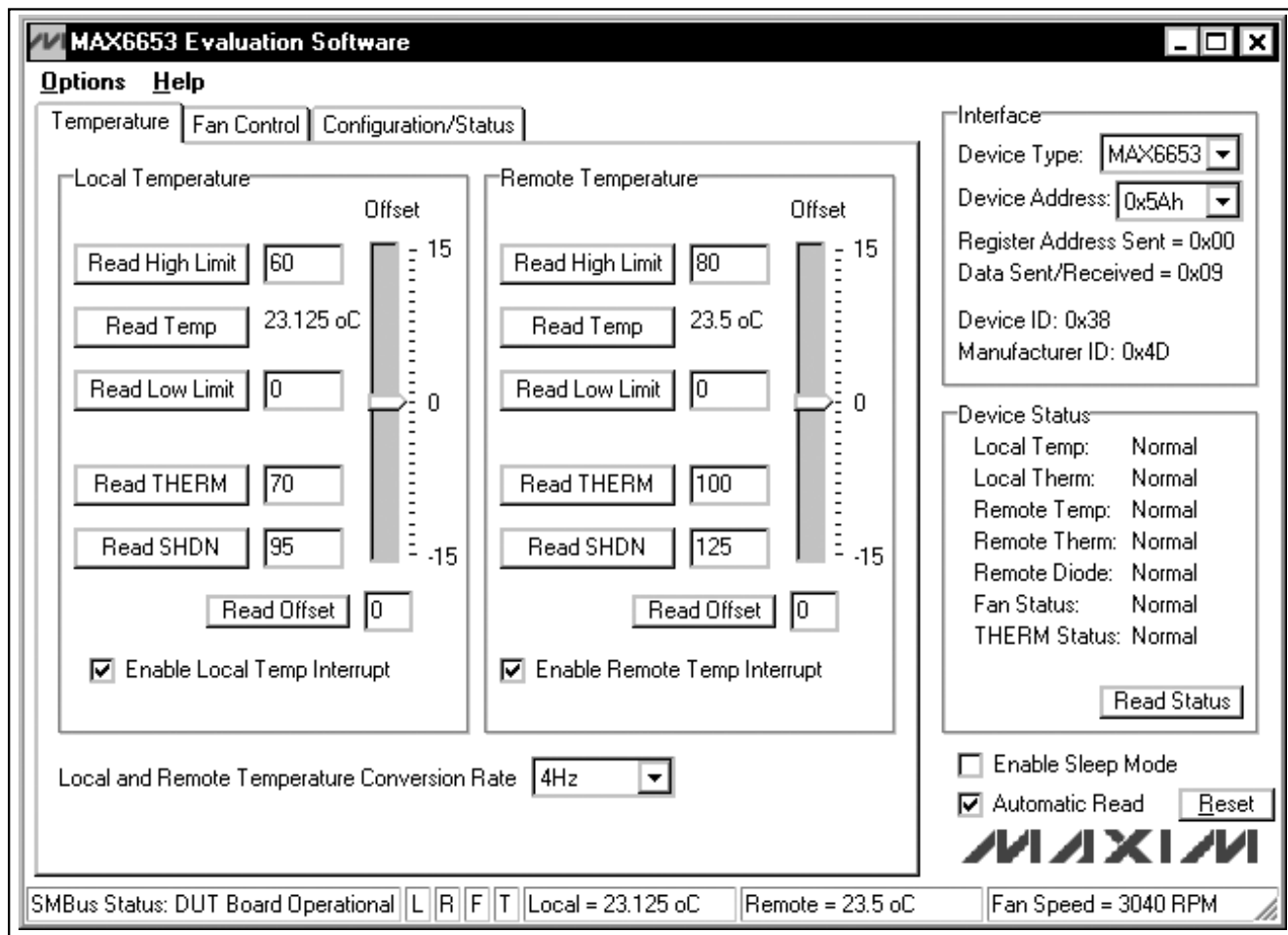

Figure 1. MAX6653 EV Kit Software Main Window (Fan Control Panel)

lower right of the main window. Click the **Read Status** button to force a status register read, or check the **Automatic Read** checkbox to automatically read the status registers every 250ms. To enable/disable the sleep mode of the MAX6653, check/uncheck the **Enable Sleep Mode** checkbox.

Note: Words in boldface are user-selectable features in the software.

Temperature Controls

The MAX6653 EV kit software (Figure 1) allows the user to read the temperature (**Read Temp**), temperature limits (**Read High Limit** and **Read Low Limit**), and THERM/shutdown critical limits (**Read THERM** and **Read SHDN**). Alternatively, a number can be entered in the corresponding edit boxes to write to the appropriate

register. Temperature offset can be read by clicking the **Read Offset** button. Enter a number in the offset edit box or move the slider to write to the offset register.

Temperature conversion rate is controlled by the **Local and Remote Temperature Conversion Rate** drop-down box. Temperature interrupt enables are controlled by the **Enable Local Temp Interrupt** and **Enable Remote Temp Interrupt** checkboxes.

Fan Controls (Temperature) Automatic Mode

Selecting the **Fan Control** tab (Figure 2a) of the MAX6653 EV kit software allows the user to adjust all fan-related registers. Clicking the appropriate radio button in the Control Mode Selection panel can change the fan operating mode. Fan functions such as **Spin-Up**

MAX6653 Evaluation System/Evaluation Kit

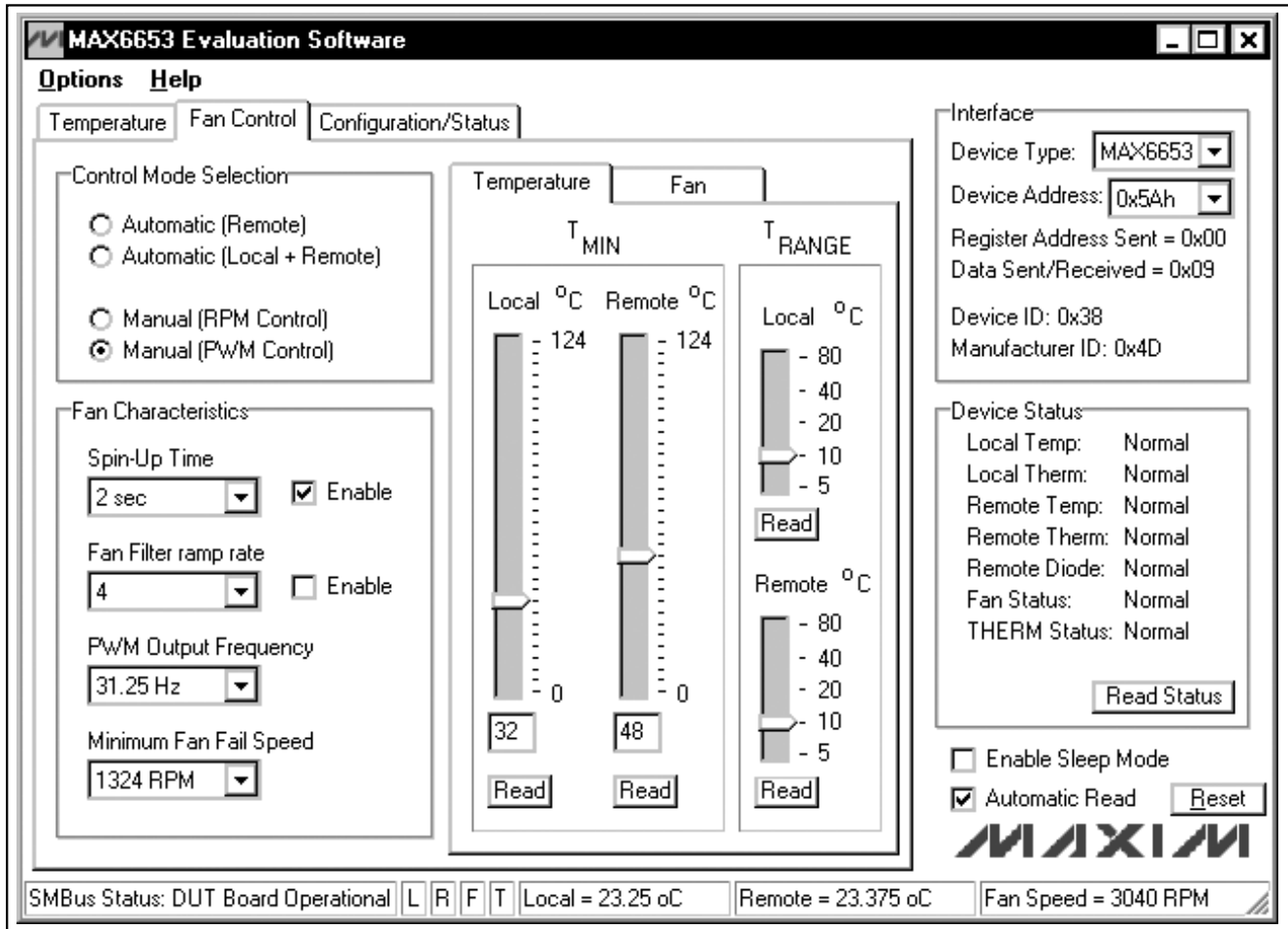

Figure 2a. MAX6653 EV Kit Software Main Window (Fan Control Panel)

Time, Fan Filter ramp rate, PWM Output Frequency, and Minimum Fan Fail Speed can be adjusted by choosing the desired option from the respective drop-down box in the Fan Characteristics panel. When in this mode, the fan-fail speed is set by adjusting the slider on the **Fan** control tab. Enable the **Spin-Up Time** and **Fan Filter ramp rate** by checking the corresponding **Enable** checkbox.

Adjust the local and remote T_{MIN} values by entering a number in their respective edit box or move the sliders until the desired value is reached. Adjust the local and remote T_{RANGE} values by moving their respective sliders. All of these values can be read back from the device by clicking the appropriate **Read** button.

Fan Controls (Fan) Manual Modes

If either the **Manual (RPM Control)** or **Manual (PWM Control)** is selected in the Control Mode Selection panel, the Fan Control tab is displayed (see Figure 2b). Depending on the mode of operation, the slider on the left-hand side either sets the Target Fan Speed (RPM control mode only) or the Fan Fail Speed (all other modes). To adjust the Target/Fan Fail Speed, move the **Fan Fail Speed (RPM)** slider or enter a number in the edit box below the slider. To adjust the PWM value, move the **PWM** slider or enter a number in the edit box below the slider (refer to the MAX6653/MAX6663/ MAX6664 data sheet for more details). Both values can be read back by pressing the corresponding **Read** button.

MAX6653 Evaluation System/Evaluation Kit

Evaluates: MAX6653/MAX6663/MAX6664

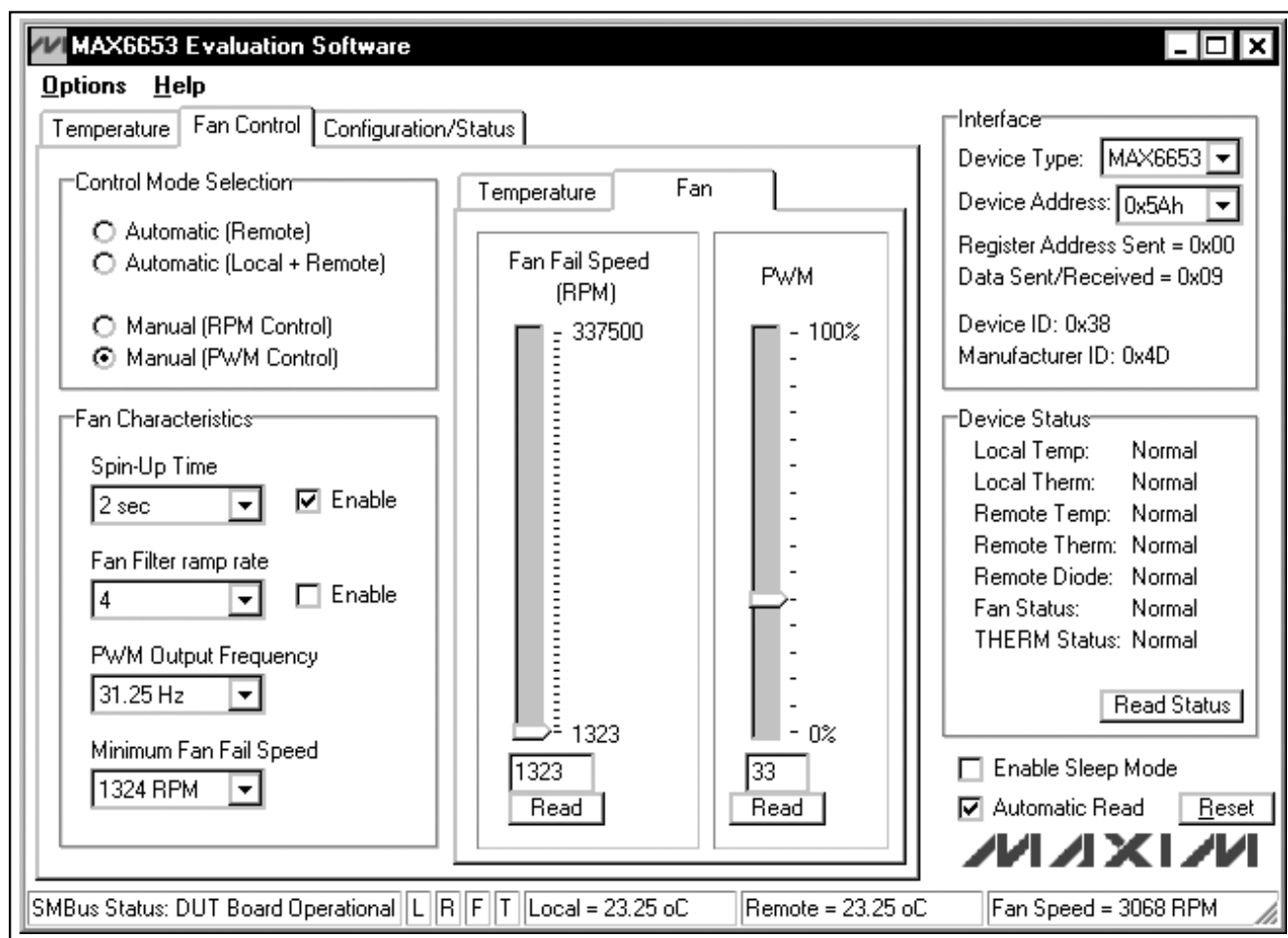

Figure 2b. MAX6653 EV Kit Software Main Window (Fan Control Panel)

Configuration Controls

Selecting the Configuration/Status tab (Figure 3) of the MAX6653 EV kit software allows the user to adjust configuration features of the MAX6653. The fan tachometer type can be set by selecting **TACH = Analog Input** or **TACH = Digital Input** in the Fan Configuration panel. The MAX6653 tachometer input is enabled by checking the **Enable TACH Input** checkbox. The PWM output is enabled by checking the **Enable PWM Output** checkbox. The PWM output is inverted by checking the **Invert PWM Output** checkbox.

The interrupt output of the MAX6653 can be enabled or masked by checking the **Enable INT Output** or the **Mask INT** checkbox, respectively. Enable the FAN FAULT output by checking the **Enable FAN_FAULT Output** checkbox. Enable the SMBus timeout function

by checking the **Enable SMB Timeout** checkbox.

Enable the THERM to full-speed function by checking the **Enable THERM to Full Speed** checkbox (refer to the description of register 0x3F/bit 7 in the MAX6653/MAX6663/MAX6664 data sheet for more details).

For a detailed description of these functions, refer to the MAX6653/MAX6663/MAX6664 data sheet.

Status Bar

At the bottom of the MAX6653 EV kit software main window is a status bar that displays vital EV kit information. Figure 4 outlines the information that is displayed on the status bar. The status bar is updated every 250ms.

Simple SMBus Commands

There are two methods for communicating with the MAX6653: Through the normal user-interface panel or

MAX6653 Evaluation System/Evaluation Kit

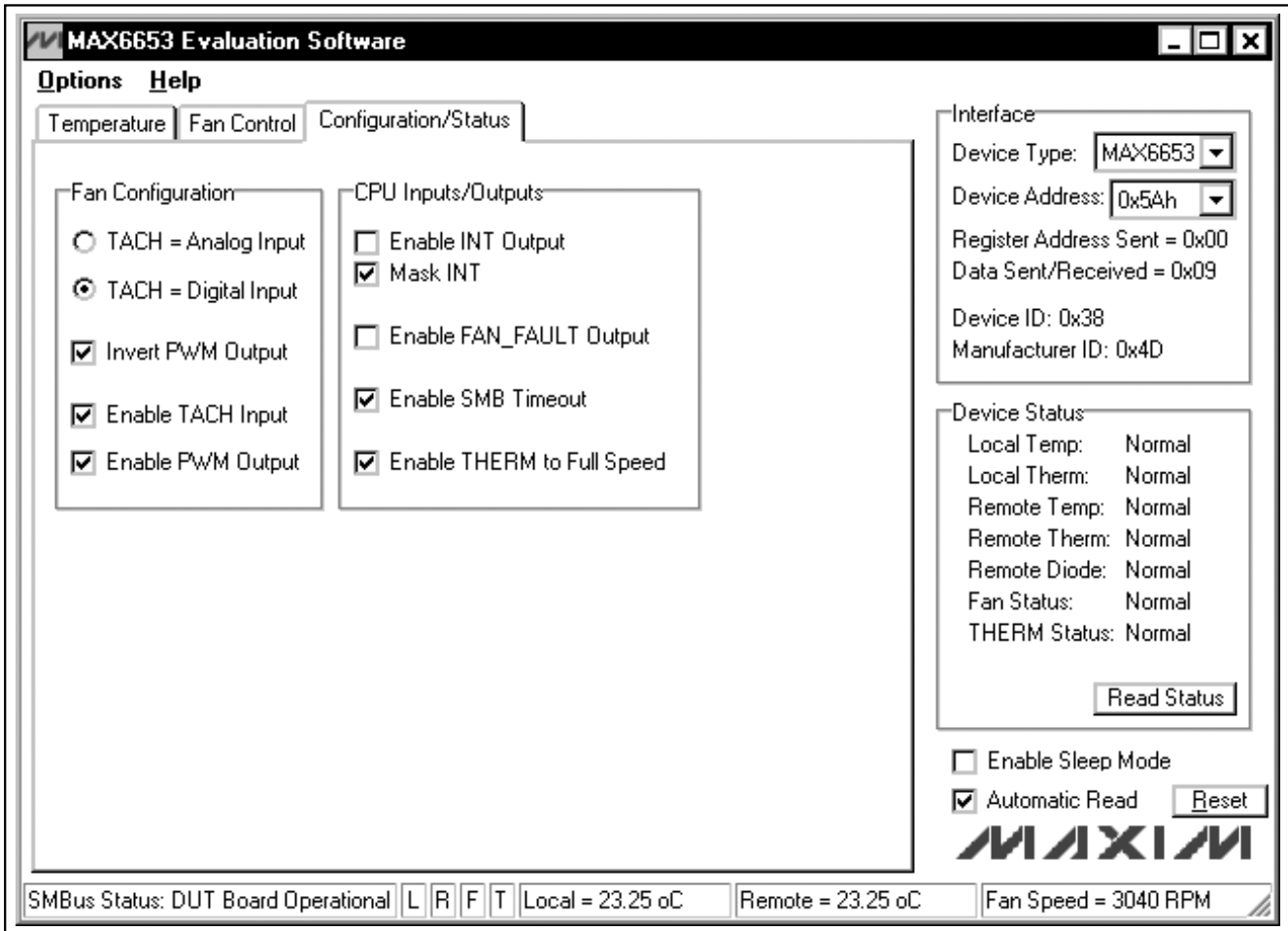

Figure 3. MAX6653 EV Kit Software Main Window (Configuration/Status)

through the SMBus commands available by selecting the **2-Wire Interface Diagnostic** item from the **Options** pulldown menu. A display pops up that allows the SMBus protocols, such as Read Byte and Write Byte, to be executed.

The SMBus dialog boxes accept numeric data in binary, decimal, or hexadecimal. Hexadecimal numbers should be prefixed by \$ or 0x. Binary numbers must be exactly eight digits. See Figure 5 for an example of this tool. In this example, the software is reading data (0x00) from Device Address 0x5D, Register Address 0x08. The sequence in Figure 5 reads the fan-speed register of the MAX6653.

Note: In places where the slave address asks for an 8-bit value, it must be the 7-bit slave address of the MAX6653 as determined by ADD with the last bit set to

1 for a read operation or a zero for a write. Refer to the MAX6653/MAX6663/MAX6664 data sheet for a complete list of registers and functions.

Detailed Description of Hardware

The MAX6653 EV kit is an assembled and tested PC board that demonstrates the MAX6653 local/remote temperature sensor and fan-speed regulator. It monitors the junction temperature of a local and external diode-connected transistor, and converts the temperature to 11-bit, 2-wire serial data.

A 2N3906 temperature-sensor transistor comes soldered to the board in a SOT23 package, but it can be removed to enable using an off-board temperature sensor (see the *Using an Off-Board Remote Sensor* section).

MAX6653 Evaluation System/Evaluation Kit

Evaluates: MAX6653/MAX6663/MAX6664

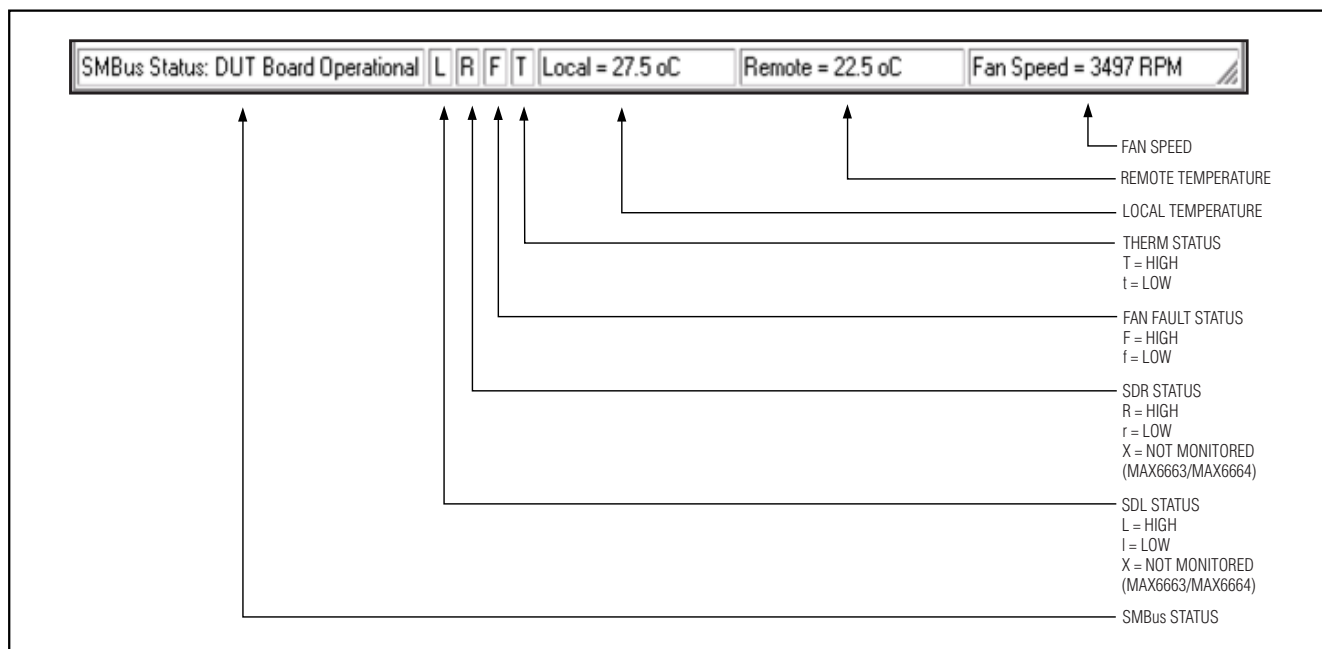

Figure 4. SMBus Status, Selected MAX6653 Signal Pins. See the MAX1609 Signal Monitor Section; Local/Remote Temperature and Fan-Speed Information Are Displayed on the Status Bar.

To ease evaluation, a MAX1609 is used to monitor selected signals of the MAX6653 (see the MAX1609 Signal Monitor section).

Address Selection

Jumper JU6 sets the MAX6653 slave address. The default address is 0101 101Y (ADD = VDUT). See Table 1 for a complete list of addresses. The MAX6653 must undergo a power-on reset for the new address to become effective.

Note: The first 7 bits shown are the address. Y (bit 0) is the SMBus read/write bit. This bit is a 1 for a read operation or a zero for a write.

Default Critical Limits

Jumpers JU4 and JU5 control the default critical limits of the MAX6653. These critical limits are directly linked to the local/remote THERM and shutdown settings of the MAX6653 (refer to the MAX6653/MAX6663/MAX6664 data sheet for more details). See Table 2 for critical limit shunt positions.

Manual THERM Control

Jumper JU7 controls the manual THERM pulldown function of the MAX6653 EV kit. Removing the shunt from JU7 allows the THERM function to be controlled by an external signal source connected to the THERM pad. See Table 3 for shutdown shunt positions.

Table 1. Shunts Settings for SMBus Address (JU6)

SHUNT POSITION	MAX6653 ADDRESS PIN	MAX6653 ADDRESS	
		BINARY	HEXADECIMAL
1-2*	VDUT	0101 101Y	0x5A
2-3	GND	0101 100Y	0x58
Not installed	No connect	0101 110Y	0x5C

*Default configuration: JU6 (1-2).

Using an Off-Board Remote Sensor

The MAX6653 EV kit is capable of using an off-board remote temperature sensor. To use this feature, cut the trace at JU8 and install the remote sensor to the DXP and DXN pads.

Using a Fan with a Tachometer Output

To use a fan with a tachometer output, remove the shunt from JU3 and connect the tachometer output of the fan to the TACH/AIN pad. Alternatively, the tachometer output can be connected to pin 2 of jack J2 (see the Fan Connector section). See Table 4 for digital tachometer shunt positions.

MAX6653 Evaluation System/Evaluation Kit

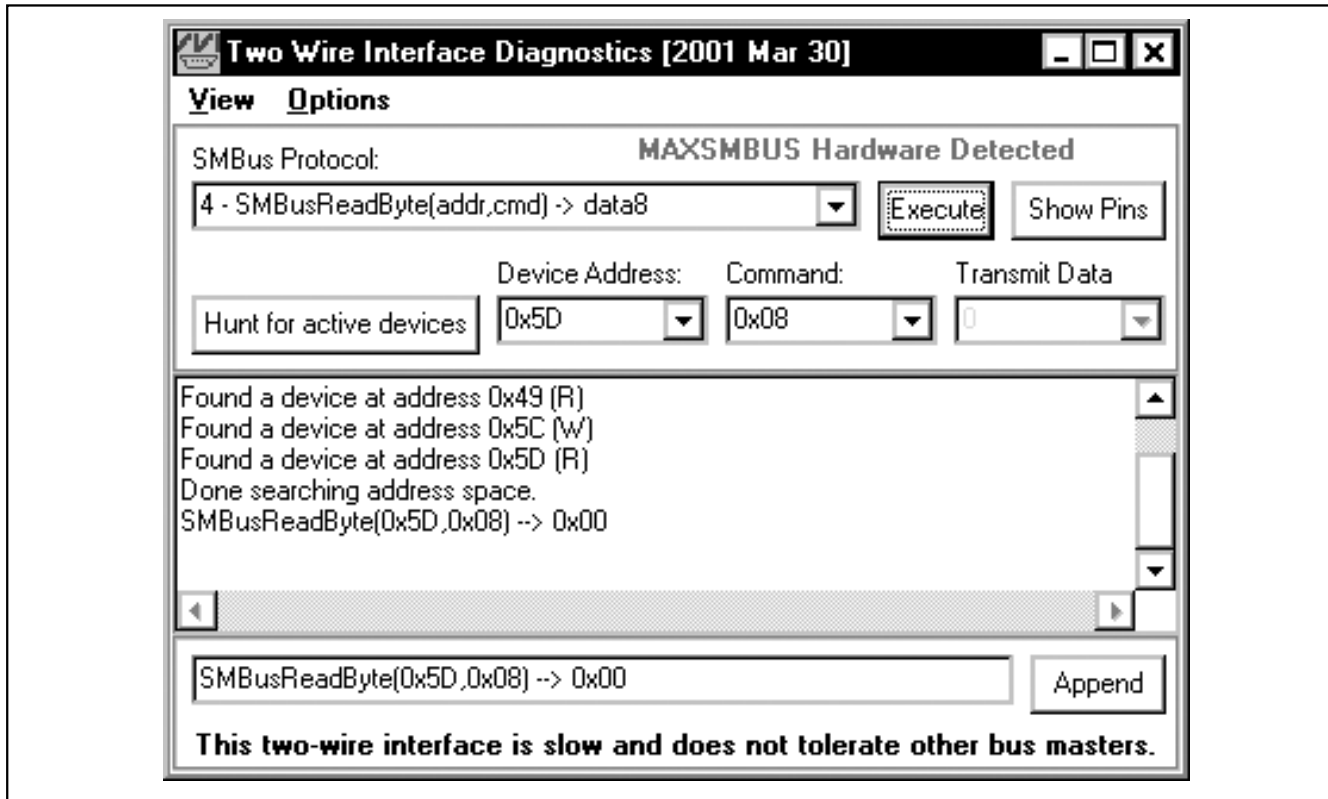

Figure 5. Simple SMBusReadByte Operation Using the Included 2-Wire Interface Diagnostics

Table 2. THERM/Shutdown Default Critical Limits (JU4, JU5)

SHUNT POSITION		DEFAULT THERM LIMIT (°C)		DEFAULT SHUTDOWN LIMIT (°C)	
JU4	JU5	LOCAL (0x16)	REMOTE (0x1A)	LOCAL (0x1B)	REMOTE (0x1C)
2-3	OPEN	55	85	80	110
2-3	2-3	60	90	85	115
2-3	1-2	65	95	90	120
OPEN*	OPEN*	70	100	95	125
OPEN	2-3	75	105	95	125
OPEN	1-2	80	110	95	125
1-2	OPEN	85	115	95	125
1-2	2-3	90	120	95	125
1-2	1-2	95	125	95	125

*Default configuration: JU4 (OPEN), JU5 (OPEN).

MAX6653 Evaluation System/Evaluation Kit

Evaluates: MAX6653/MAX6663/MAX6664

Table 3. Manual THERM Control (JU7)

SHUNT POSITION	DESCRIPTION
Installed	THERM pulled low
Not installed*	THERM pulled high or controlled with an external signal source

*Default configuration: JU7 (not installed).

MAX1609 Signal Monitor

An on-board MAX1609 continuously monitors the SDR, SDL, FAN FAULT, and THERM signals of the MAX6653. To ensure that this device is always active, use switch S1 to enable/disable power to the MAX6653.

Fan Connector

A fan may be connected to jack J2. See Table 5 for connector pinout information.

Evaluating the MAX6663/MAX6664

To evaluate the MAX6663/MAX6664, remove the MAX6653 IC (U1) and replace it with a MAX6663AEE/MAX6664AEE. Cut the trace between jumpers JU1 and JU2 and remove the shunts from JU4 and JU5.

After loading up the MAX6653 EV kit software, change the **Device Type** to MAX6663 or MAX6664. When using the MAX6663/ MAX6664, the SDR and SDL lines are not monitored and the default THERM and shutdown

Table 4. Tachometer Input Settings (JU3)

SHUNT POSITION	DESCRIPTION
Installed	Fan does not have a tachometer output. (Remove resistor R10.)
Not installed*	Fan has a tachometer output.

*Default configuration: JU3 (not installed).

Table 5. Fan Connector Pinout (J2)

PIN	SIGNAL
1	FAN+
2	Tachometer input
3	FAN-

critical limit values cannot be changed through jumpers JU4 and JU5. Refer to the MAX6653/MAX6663/MAX6664 data sheet for a complete description of part-to-part differences.

Using a High-Current Fan

The MAX6653 EV kit is capable of driving a high-current fan (greater than 0.5A) with minimal modifications. Replacing resistor R9 with a 0Ω resistor allows up to 1.0A fans to be used.

Component Suppliers

SUPPLIER	PHONE	FAX	WEBSITE
Central Semiconductor	631-435-1110	631-435-1824	www.centralsemi.com
Diodes Inc.	805-446-4800	805-446-4850	www.diodes.com
Fairchild	888-522-5372	N/A	www.fairchildsemi.com
IRC	361-992-7900	361-992-3377	www.icrtt.com
TDK	847-803-6100	847-390-4405	www.component.tdk.com
Vishay-Dale	402-564-3131	402-563-6296	www.vishay.com

Note: Please indicate that you are using the MAX6653 when contacting these component suppliers

MAX6653 Evaluation System/Evaluation Kit

Evaluates: MAX6653/MAX6663/MAX6664

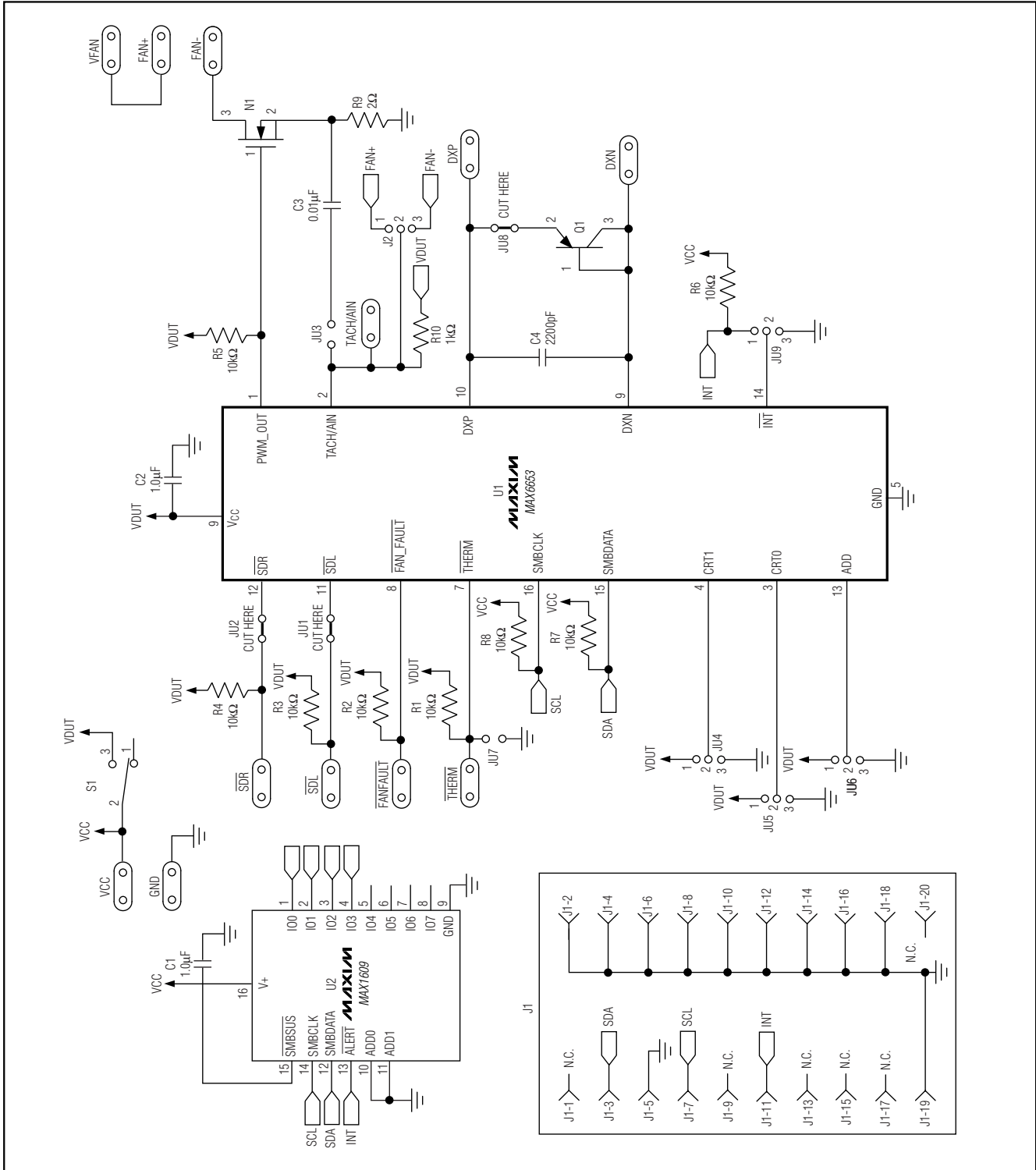

Figure 6. MAX6653 EV Kit Schematic

MAX6653 Evaluation System/Evaluation Kit

Evaluates: MAX6653/MAX6663/MAX6664

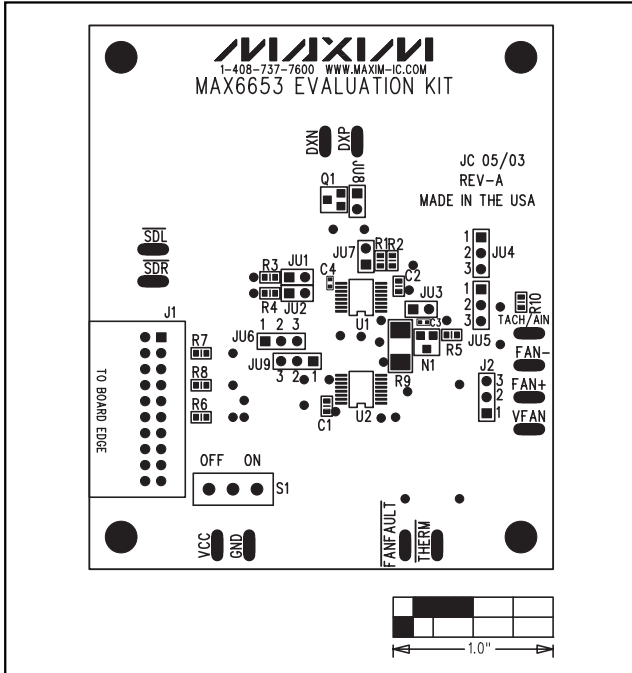

Figure 7. MAX6653 EV Kit Component Placement Guide—Component Side

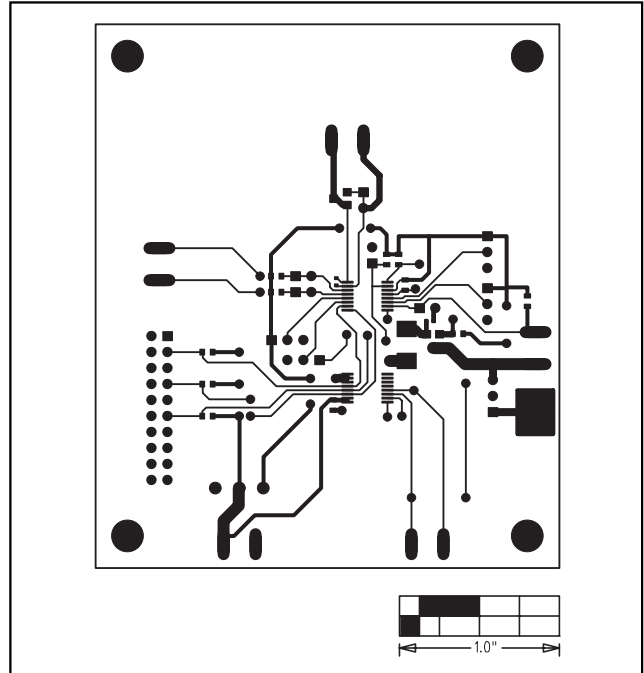

Figure 8. MAX6653 EV Kit PC Board Layout—Component Side

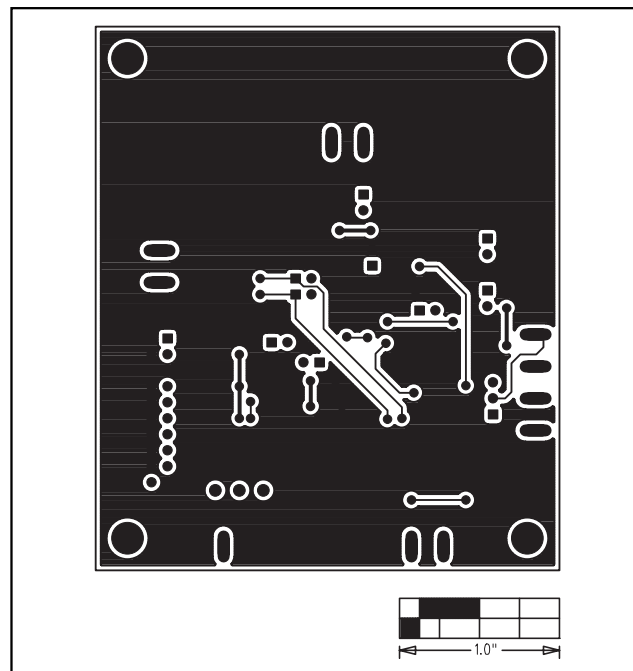

Figure 9. MAX6653 EV Kit PC Board Layout—Solder Side

Maxim cannot assume responsibility for use of any circuitry other than circuitry entirely embodied in a Maxim product. No circuit patent licenses are implied. Maxim reserves the right to change the circuitry and specifications without notice at any time.

Maxim Integrated Products, 120 San Gabriel Drive, Sunnyvale, CA 94086 408-737-7600 _____ 11