

## SPECIFICATIONS

<b>CUSTOMER</b>	:	_____
<b>SAMPLE CODE</b>	:	SH800480T013-IHC03
<b>MASS PRODUCTION CODE</b>	:	PH800480T013-IHC03
<b>SAMPLE VERSION</b>	:	01
<b>SPECIFICATIONS EDITION</b>	:	003
<b>DRAWING NO. (Ver.)</b>	:	LMD-PH800480T013-IHC03 (Ver.002)
<b>PACKAGING NO. (Ver.)</b>	:	PKG-PH800480T013-IHC03 (Ver.001)

**Customer Approved**

**Date:** \_\_\_\_\_

Approved	Checked	Designer
黃秋源 Oliver Huang	石建莊 Stone Shin	黃俊清 Ackey Huang



- Preliminary specification for design input
- Specification for sample approval

### POWERTIP TECH. CORP.

**Headquarters:**

No.8, 6<sup>th</sup> Road, Taichung Industrial Park,  
Taichung, Taiwan  
台中市 407 工業區六路 8 號

TEL: 886-4-2355-8168  
FAX: 886-4-2355-8166

E-mail: [sales@powertip.com.tw](mailto:sales@powertip.com.tw)  
[Http://www.powertip.com.tw](http://www.powertip.com.tw)



## Contents

### 1. SPECIFICATIONS

- 1.1 Features
- 1.2 Mechanical Specifications
- 1.3 Absolute Maximum Ratings
- 1.4 DC Electrical Characteristics
- 1.5 Optical Characteristics
- 1.6 Backlight Characteristics
- 1.7 Touch Panel Characteristics

### 2. MODULE STRUCTURE

- 2.1 Counter Drawing
- 2.2 Interface Pin Description
- 2.3 Timing Characteristics

### 3. QUALITY ASSURANCE SYSTEM

- 3.1 Quality Assurance Flow Chart
- 3.2 Inspection Specification

### 4. RELIABILITY TEST

- 4.1 Reliability Test Condition

### 5. PRECAUTION RELATING PRODUCT HANDLING

- 5.1 Safety
- 5.2 Handling
- 5.3 Storage
- 5.4 Terms of Warranty

Appendix : LCM Drawing.  
LCM Packaging Specifications.

## 1. SPECIFICATIONS

### 1.1 Features

Item	Standard Value
Display Resolution	800 * 3 (RGB) * 480 Dots
LCD Type	a-Si TFT , Normally white , Transmissive type
Screen size(inch)	7.0 inch
Viewing Direction	6 O'clock
Surface treatment	Anti-Glare
Color configuration	R.G.B. Vertical Stripe
Touch panel	Projective Capacitive Touch Panel 5 Points touch
Backlight Type	White LED B/L
Weight	168 g
Interface	LVDS Interface(6 BIT)
ROHS	THIS PRODUCT CONFORMS THE ROHS OF PTC Detail information please refer website : <a href="http://www.powertip.com.tw/news_detail.php?Key=1&amp;clD=1">http://www.powertip.com.tw/news_detail.php?Key=1&amp;clD=1</a>

### 1.2 Mechanical Specifications

Item	Standard Value	Unit
Outline Dimension	186.8 (W) * 110.56 (L) * 9.17 (H)	mm

#### LCD panel

Item	Standard Value	Unit
Active Area	154.08 (W) * 85.92 (L)	mm

Note : For detailed information please refer to LCM drawing.

### 1.3 Absolute Maximum Ratings

#### Module

Item	Symbol	Condition	Min.	Max.	Unit	Remark
Power Supply for TFT Panel	VCC	VSS=0	-0.3	+5.0	V	
Power Supply for Backlight	V5V		-	+20.0	V	
Operating Temperature	T <sub>OP</sub>	-	-20	+70	°C	
Storage Temperature	T <sub>ST</sub>	-	-30	+80	°C	

The absolute maximum rating values of this product are not allowed to be exceeded at any times. Should a module be used with any of the absolute maximum ratings exceeded, the characteristics of the module may not be recovered, or in an extreme case, the module may be permanently destroyed.

### 1.4 DC Electrical Characteristics

#### Module

VSS = 0V, Ta = 25°C

Item	Symbol	Min.	Typ.	Max.	Unit	Remark
Power Supply Voltage	VCC	3.0	3.3	3.6	V	
Power Supply Voltage For Led Driver	V5V	-	5.0	-	V	
Input Voltage for TFT Panel	V <sub>IH</sub>	0.7VCC	-	VCC	V	
	V <sub>IL</sub>	0	-	0.3VCC	V	
Supply Current	ICC	-	110	-	mA	Pattern = Picture
		-	110	165		Pattern = Red *1

Note1: Maximum current display.

## 1.5 Optical Characteristics

### TFT LCD Module

VCC = 3.3 V, Ta=25°C

Item		Symbol	Condition	Min.	Typ.	Max.	unit	
Response time	Rise	Tr	Ta = 25°C θX, θY = 0°	-	10	20	ms	Note 2
	Fall	Tf		-	15	30		
Viewing angle	Top	θY+	CR ≥ 10	40	50	-	Deg.	Note 4
	Bottom	θY-		60	70	-		
	Left	θX-		60	70	-		
	Right	θX+		60	70	-		
Contrast ratio		CR		400	500	-	-	Note 3
Color of CIE Coordinate ( With B/L & Touch Panel )	White	X	Ta = 25°C θX, θY = 0°	0.24	0.29	0.34	-	Note1
		Y		0.27	0.32	0.37		
	Red	X		0.51	0.56	0.61		
		Y		0.30	0.35	0.40		
	Green	X		0.28	0.33	0.38		
		Y		0.53	0.58	0.63		
	Blue	X		0.09	0.14	0.19		
		Y		0.02	0.07	0.12		
Average Brightness Pattern=white display (With B/L & Touch Panel )*1		IV	V5V=5.0V PWCTRL="High"	680	850	-	-	Note1
Uniformity (With B/L & Touch Panel )*2		△B	V5V=5.0V PWCTRL="High"	70	-	-	%	Note1

Note 1:

\*1 :  $\Delta B = B(\text{min}) / B(\text{max}) * 100\%$

\*2 : Measurement Condition for Optical Characteristics:

- a : Environment:  $25^{\circ}\text{C} \pm 5^{\circ}\text{C}$  /  $60 \pm 20\% \text{R.H}$  , no wind , dark room below 10 Lux at typical lamp current and typical operating frequency.
- b : Measurement Distance:  $500 \pm 50 \text{ mm}$  , ( $\theta = 0^{\circ}$ )
- c : Equipment: TOPCON BM-7 fast , (field  $1^{\circ}$ ) , after 10 minutes operation.
- d : The uncertainty of the C.I.E coordinate measurement  $\pm 0.01$  , Average Brightness  $\pm 4\%$

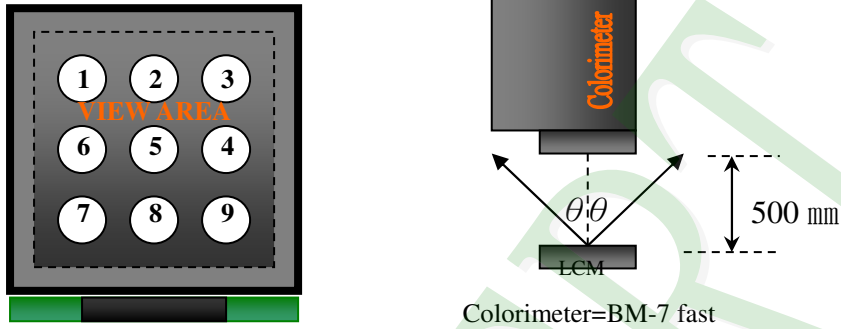

To be measured at the center area of panel with a viewing cone of  $1^{\circ}$  by Topcon luminance meter BM-7, after 10 minutes operation (module)

Note2: Definition of response time:

The output signals of photo detector are measured when the input signals are changed from "black" to "white"(falling time) and from "white" to "black"(rising time), respectively. The response time is defined as the time interval between the 10% and 90% of Amplitudes.

Refer to figure as below:

Normally White



### Normally Black

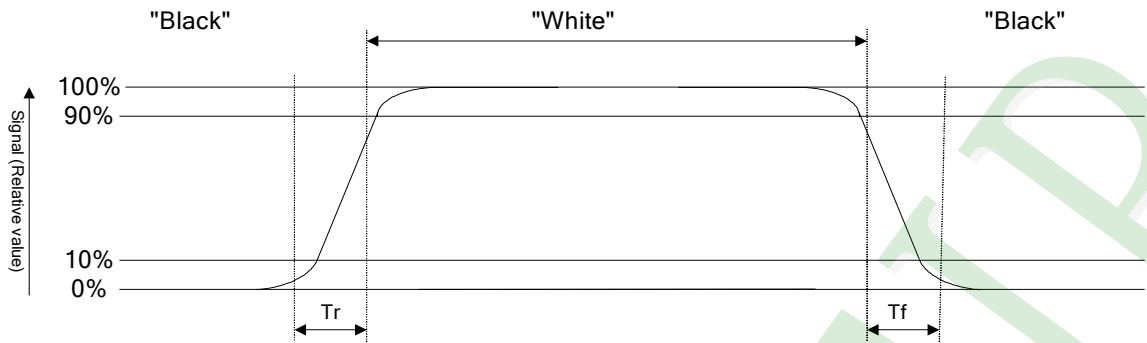

Note3: Definition of contrast ratio:

Contrast ratio is calculated with the following formula

$$\text{Contrast ratio (CR)} = \frac{\text{Photo detector output when LCD is at "White" state}}{\text{Photo detector output when LCD is at "Black" state}}$$

Note4: Definition of viewing angle:

Refer to figure as below:

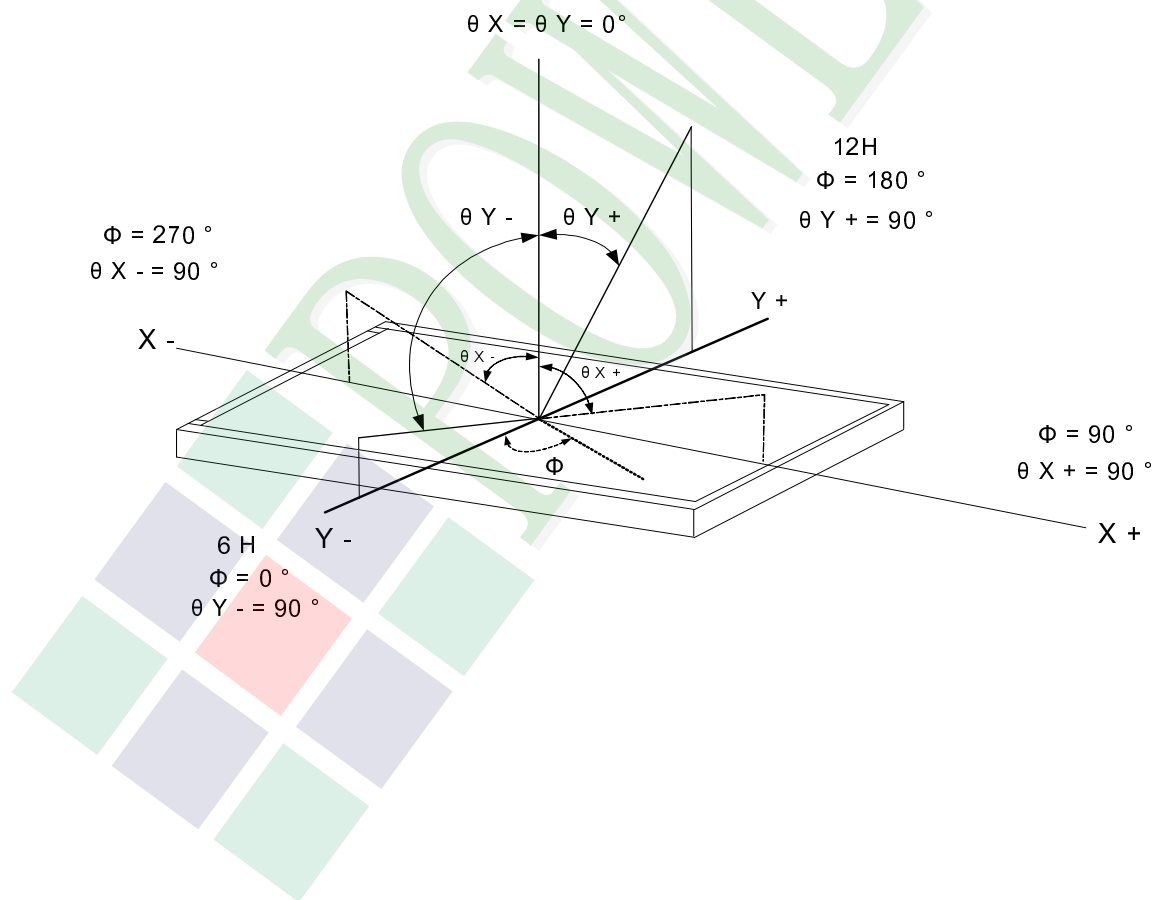



## 1.6 Backlight Characteristics

### Electrical / Optical Characteristics

Item	Symbol	Min.	Typ.	Max.	Unit	Note	
Power Supply for Backlight	V5V	-	5.0	-	V	Ta = 25°C	
Supply Current for Backlight	IV5V	-	1.0	1.5	A		
LED Driver output Voltage	VF	14.7	18.0	19.2	V	-	
LED Driver output Current	IF	-	140		mA	-	
PWM Signal Voltage	High	PWMCTRL	2.0	-	-	V	-
	Low		-	-	0.8		
PWM Frequency	PWMCTRL	100	-	200	KHz	*1)	
LEDCTRL Signal Voltage	LEDCTRL	-	5	-	V	*2)	
Lifetime	-	50000	-	-	Hr	*3)	
Color	White					-	

\*1) PWMCTRL = 5.0 V

\*2) LEDCTRL = 5.0 V

\*3) Definition of the LED life time: Luminance (L) under 50% of the initial value. LED life time is restricted under normal condition, ambient temperature=25°C.

## PCB Board Internal Circuit:

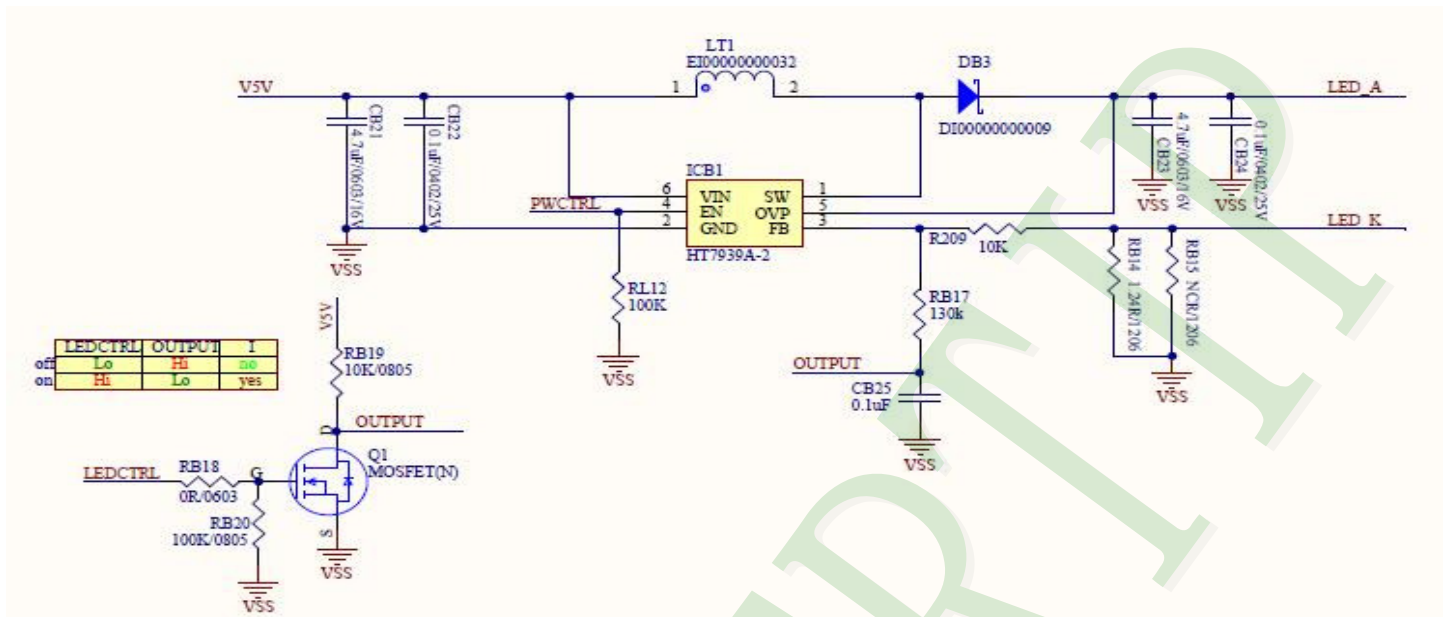

## Internal Circuit Diagram:

LED channels: 3

Series LEDs per channel: 8

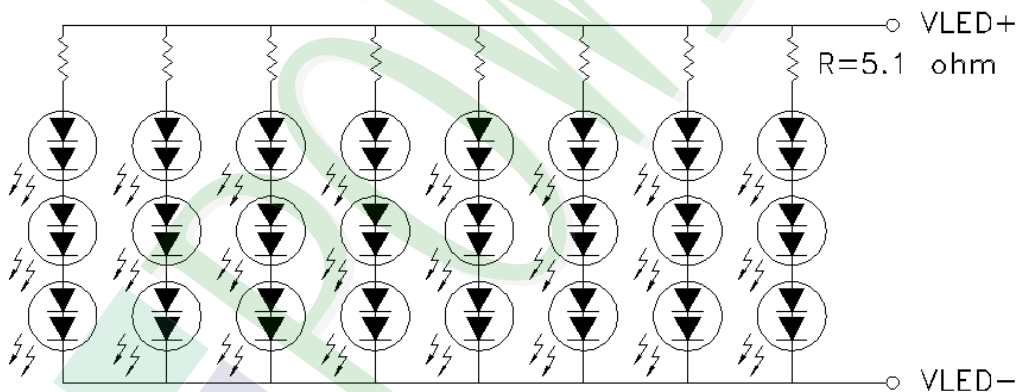

## 1.7 Touch Panel Characteristics

### Features

Item	Standard Value
Touch Panel Size	7"
Touch type	Projective Capacitive Touch Panel
Input Method	Finger / 5 Points touch
Output Interface	I <sup>2</sup> C
IC	ST1633

### I<sup>2</sup>C Address

Bit 7	Bit 6	Bit 5	Bit 4	Bit 3	Bit 2	Bit 1	Bit 0
0	1	0	1	0	1	0	R/W

Bit 0: 0 for Write / 1 for Read

### Mechanical Specifications

Item	Standard Value	Unit
Viewing Area	154.88 (W) * 86.72 (L)	mm
Number of sensing channel	20 * 12	

### Absolute Maximum Ratings

Item	Symbol	Condition	Min.	Max.	Unit
Supply voltage	VCC	-	-0.3	+5.0	V
Operating Temperature	T <sub>OP</sub>	-	-20	+70	°C
Storage Temperature	T <sub>ST</sub>	-	-30	+80	°C

### DC Electrical Characteristics

Item	Symbol	Condition	Min.	Typ.	Max.	Unit
Power Supply Voltage	VCC	-	3.0	3.3	3.6	V

### Touch Panel IC Read/Write description & Register Mapping

Reference :Sitronix Touch Driver Porting Reference Guide.

## 2. MODULE STRUCTURE

### 2.1 Counter Drawing

#### 2.1.1 LCM Mechanical Diagram

\* See Appendix

#### 2.1.2 Block Diagram

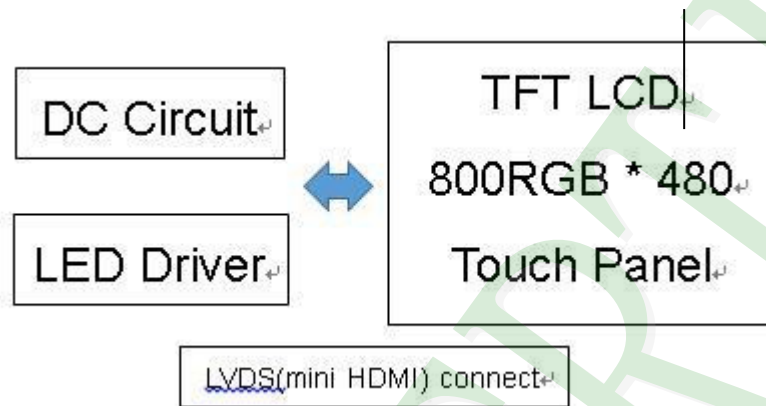

## 2.2 Interface Pin Description

### J2 Interface:

Pin#	Name
1	PWCTRL
2	VCC
3	VCC
4	VCC
5	LEDCTRL
6	NC
7	NC
8	RA_N
9	RA_P
10	VSS
11	RB_N
12	RB_P
13	VSS
14	RC_N
15	RC_P
16	VSS
17	RCLK_N
18	RCLK_P
19	VSS
20	V5V
21	V5V
22	VSS
23	VSS
24	V5V
25	V5V
26	V5V
27	I2C3_SCL(TP)
28	I2C3_SDA(TP)
29	Touch_Int(TP)
30	NC

**Note: Module & CTP Hold VCC & VSS Power.**

## 2.3 Timing Characteristics

### 2.3.1 Signal AC Characteristics

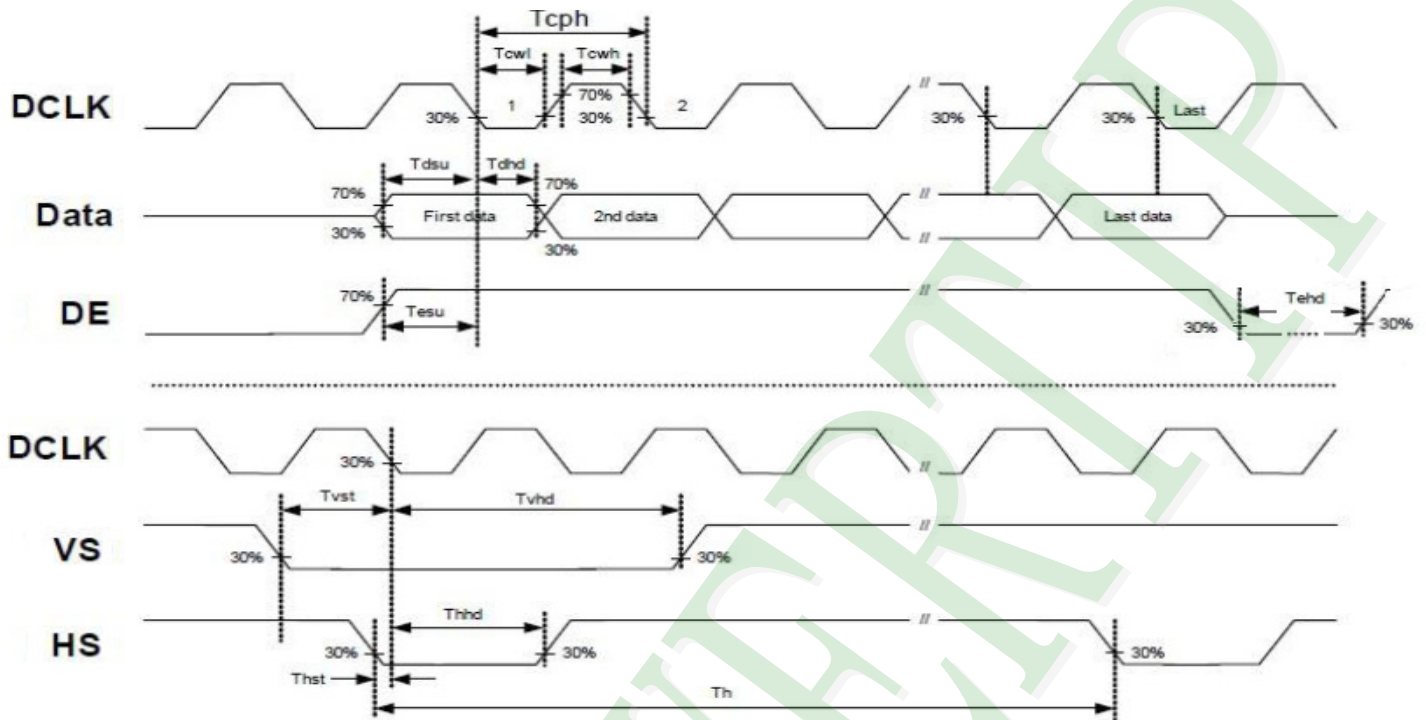

Item	Symbol	Values			Unit	Remark
		Min	Typ	Max		
HS setup time	$T_{hst}$	8	-	-	ns	
HS hold time	$T_{hhd}$	8	-	-	ns	
VS setup time	$T_{vst}$	8	-	-	ns	
VS hold time	$T_{vhd}$	8	-	-	ns	
Data setup time	$T_{dsu}$	8	-	-	ns	
Data hole time	$T_{dhd}$	8	-	-	ns	
DE setup time	$T_{esu}$	8	-	-	ns	
DE hold time	$T_{ehd}$	8	-	-	ns	
DVDD Power On Slew rate	$T_{POR}$	-	-	20	ms	From 0 to 90% DVDD
RESET pulse width	$T_{Rst}$	1	-	-	ms	
DCLK cycle time	$T_{cph}$	20	30	-	ns	
Low Level Width	$T_{cwl}$	8	-	-	ns	
High Level Width	$T_{cwh}$	8	-	-	ns	
DCLK pulse duty	Duty	40	50	60	%	$T_{cwh} / T_{cph}$

### 2.3.2 Input Timing Setting

Item	Symbol	Values			Unit	Remark
		Min.	Typ.	Max.		
Horizontal Display Area	Thd		800		DCLK	
DCLK Frequency	Fclk	26.4	33.3	46.8	MHz	
One Horizontal Line	Th	862	1056	1200	DCLK	
HS pulse width	Thpw	1		40	DCLK	
HS Blanking	Thb	46	46	46	DCLK	
HS Front Porch	Thfp	16	210	354	DCLK	

Item	Symbol	Values			Unit	Remark
		Min.	Typ.	Max.		
Vertical Display Area	Tvd		480		TH	
VS period time	Tv	510	525	650	TH	
VS pulse width	Tvpw	1		20	TH	
VS Blanking	Tvb	23	23	23	TH	
VS Front Porch	Tvfp	7	22	147	TH	

Horizontal input timing diagram

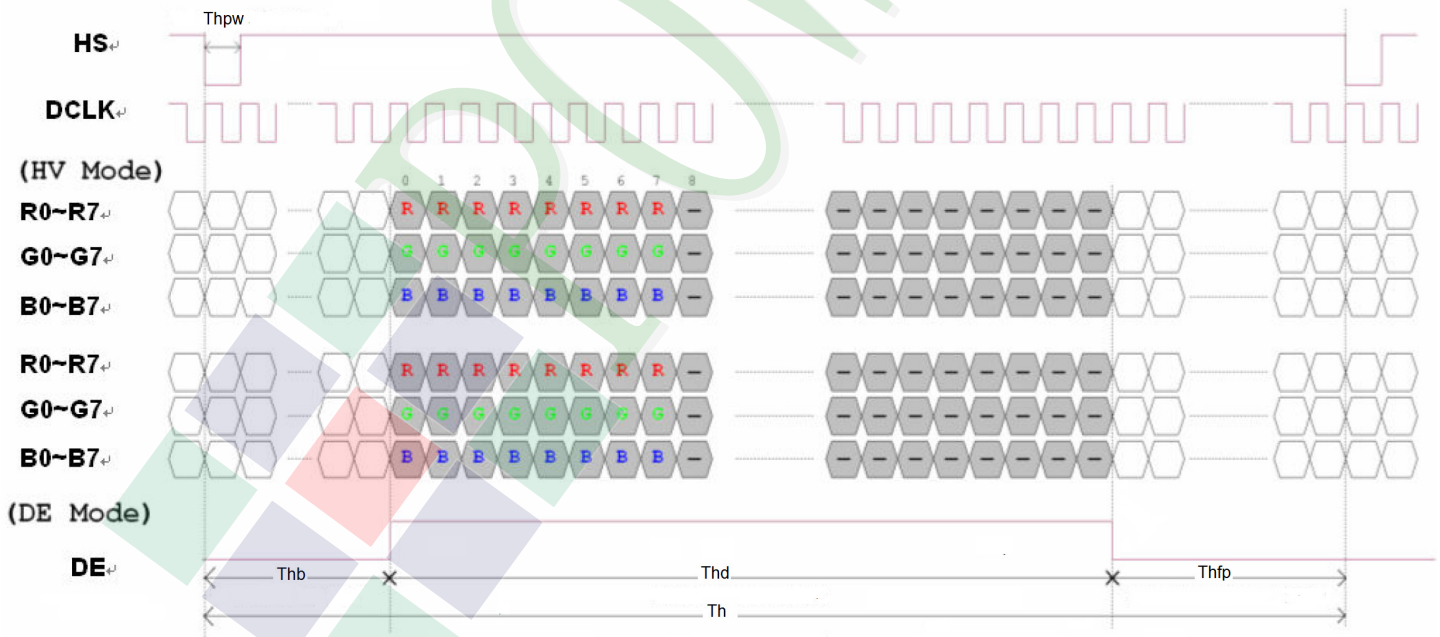

Vertical input timing diagram



### LVDS Data Input Format

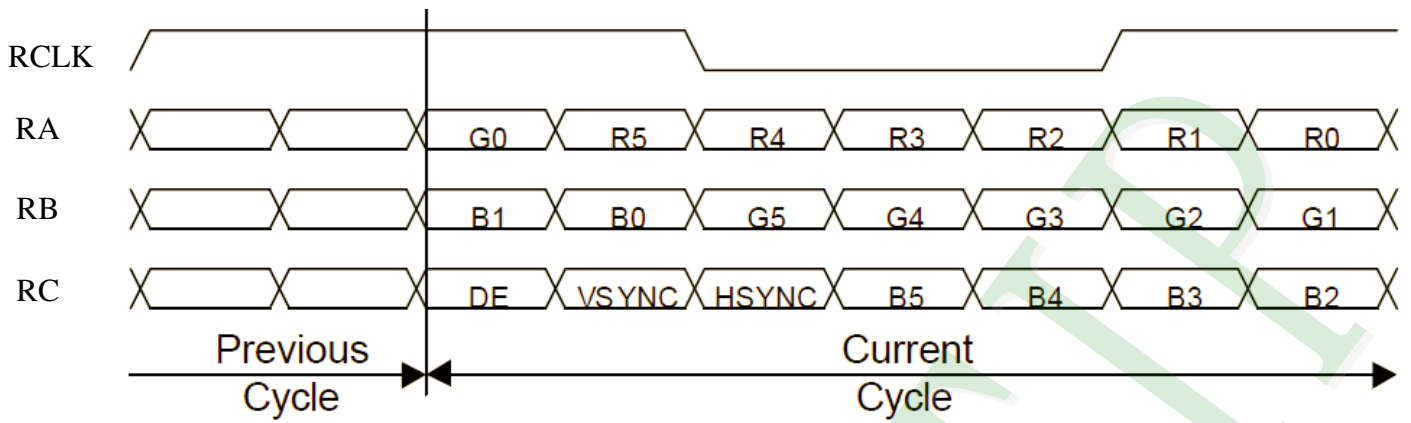

### 2.3.3 Power Sequence

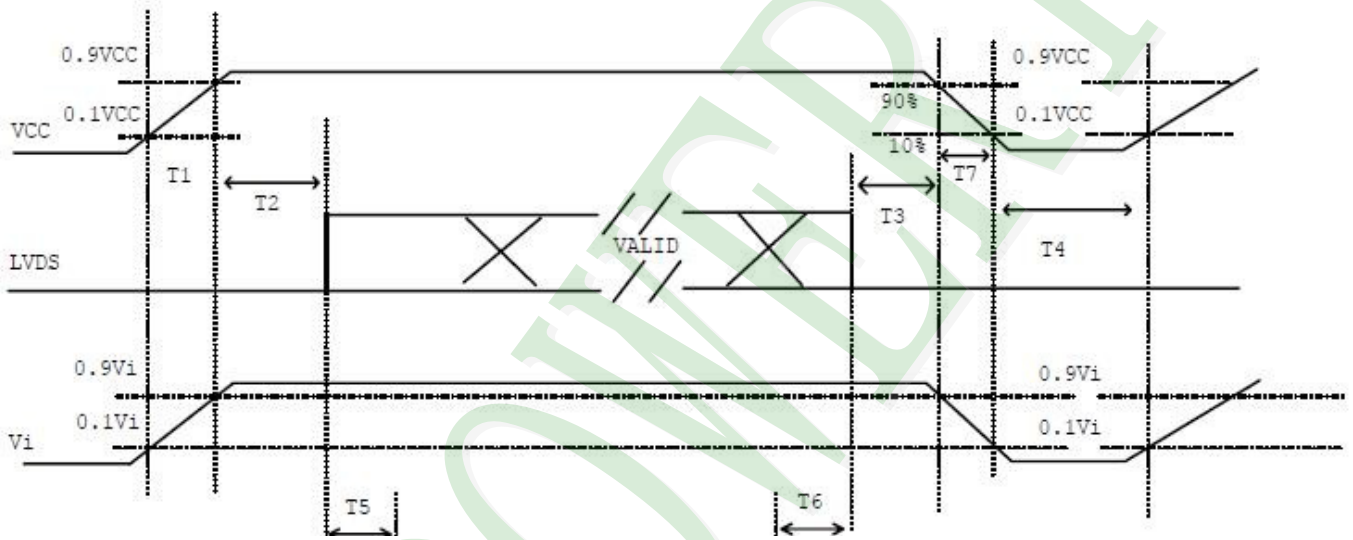



### 3. QUALITY ASSURANCE SYSTEM

#### 3.1 Quality Assurance Flow Chart

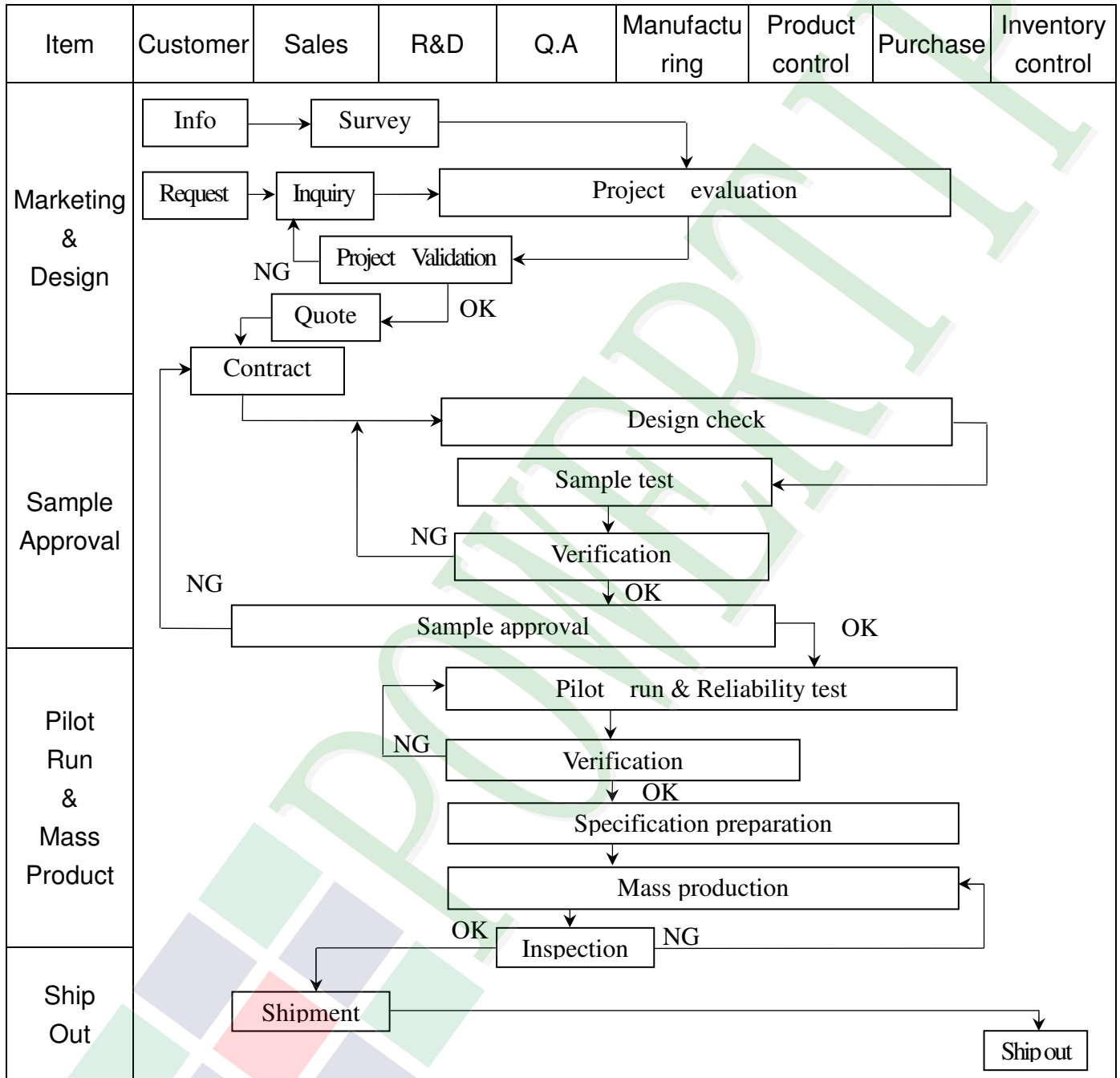

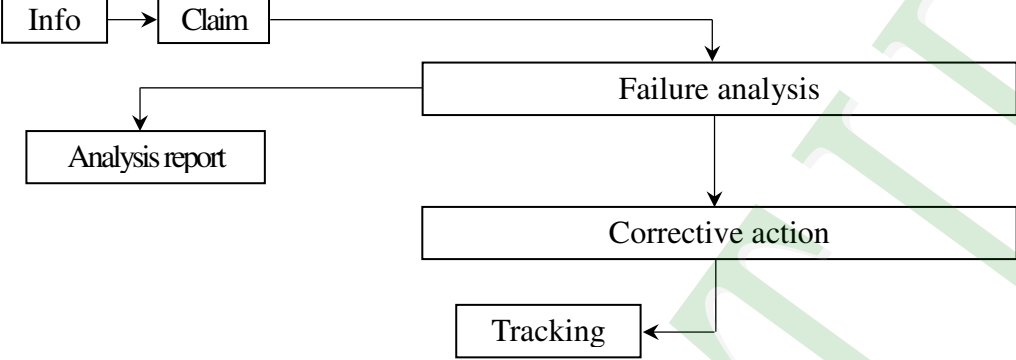
Item	Customer	Sales	R&D	Q.A	Manufacturing	Product control	Purchase	Inventory control
Sales Service	 <pre> graph TD     Info[Info] --&gt; Claim[Claim]     Claim --&gt; Failure[Failure analysis]     Failure --&gt; Report[Analysis report]     Failure --&gt; Action[Corrective action]     Action --&gt; Tracking[Tracking]           </pre>							
Q.A Activity	1. ISO 9001 Maintenance Activities 3. Equipment calibration 5. Standardization Management				2. Process improvement proposal 4. Education And Training Activities			

### 3.2. Inspection Specification

- ◆Scope : The document shall be applied to TFT-LCD Module for 3.5" ~10" (Ver.B01).
- ◆Inspection Standard : MIL-STD-105E Table Normal Inspection Single Sampling Level II.
- ◆Equipment : Gauge 、MIL-STD 、Powertip Tester 、Sample
- ◆Defect Level : Major Defect AQL : 0.4 ; Minor Defect AQL : 1.5
- ◆OUT Going Defect Level : Sampling.
- ◆Standard of the product appearance test :

a. Manner of appearance test :

- (1). The test best be under 20W×2 fluorescent light , and distance of view must be at 30 cm.
- (2). The test direction is base on about around 45° of vertical line.

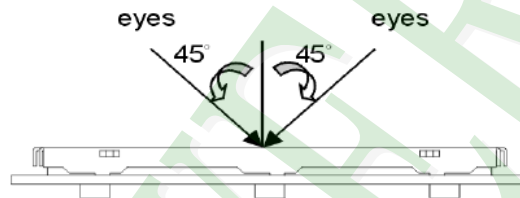

(3). Definition of area.

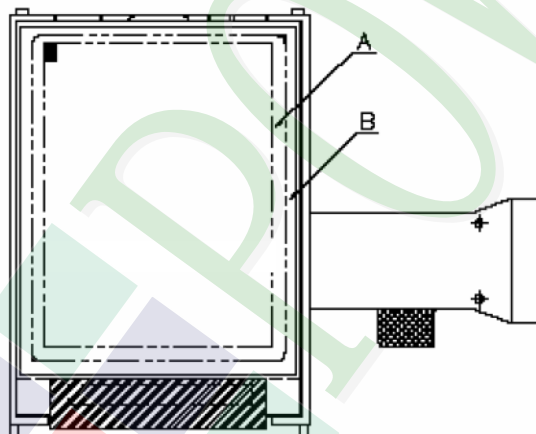

*A* area : viewing area

*B* area : Outside of viewing area

(4). Standard of inspection : (Unit : mm)

**◆ Specification For TFT-LCD Module 3.5" ~10" :**

(Ver.B01)

NO	Item	Criterion	Level										
01	Product condition	1. 1 The part number is inconsistent with work order of production.	Major										
		1. 2 Mixed product types.	Major										
		1. 3 Assembled in inverse direction.	Major										
02	Quantity	2. 1 The quantity is inconsistent with work order of production.	Major										
03	Outline dimension	3. 1 Product dimension and structure must conform to structure diagram.	Major										
04	Electrical Testing	4. 1 Missing line character and icon.	Major										
		4. 2 No function or no display.	Major										
		4. 3 Display malfunction.	Major										
		4. 4 LCD viewing angle defect.	Major										
		4. 5 Current consumption exceeds product specifications.	Major										
05	Dot defect (Bright dot 、 Dark dot)  On -display	<table border="1"> <thead> <tr> <th>Item</th> <th>Acceptance (Q'ty)</th> </tr> </thead> <tbody> <tr> <td>Bright Dot</td> <td><math>\leq 4</math></td> </tr> <tr> <td>Dark Dot</td> <td><math>\leq 5</math></td> </tr> <tr> <td>Joint Dot</td> <td><math>\leq 3</math></td> </tr> <tr> <td>Total</td> <td><math>\leq 7</math></td> </tr> </tbody> </table>	Item	Acceptance (Q'ty)	Bright Dot	$\leq 4$	Dark Dot	$\leq 5$	Joint Dot	$\leq 3$	Total	$\leq 7$	Minor
		Item	Acceptance (Q'ty)										
		Bright Dot	$\leq 4$										
		Dark Dot	$\leq 5$										
		Joint Dot	$\leq 3$										
Total	$\leq 7$												
5. 1 Inspection pattern : full white , full black , Red , Green and blue screens.													
5. 2 It is defined as dot defect if defect area $> 1/2$ dot.													
5. 3 The distance between two dot defect $\geq 5$ mm.													

**◆ Specification For TFT-LCD Module 3.5" ~10" :**

(Ver.B01)

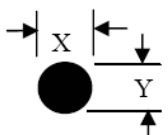
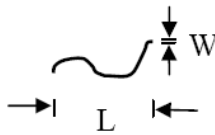
NO	Item	Criterion	Level																																								
06	<p>Black or white dot、scratch、contamination</p> <p>Round type</p>  <p><math>\Phi = (x+y) / 2</math></p> <p>Line type</p> 	<p>6.1 Round type ( Non-display or display ) :</p> <table border="1"> <thead> <tr> <th rowspan="2">Dimension (diameter : <math>\Phi</math>)</th> <th colspan="2">Acceptance (Q'ty)</th> </tr> <tr> <th>A area</th> <th>B area</th> </tr> </thead> <tbody> <tr> <td><math>\Phi \leq 0.25</math></td> <td colspan="2">Ignore</td> </tr> <tr> <td><math>0.25 &lt; \Phi \leq 0.50</math></td> <td>5</td> <td rowspan="3">Ignore</td> </tr> <tr> <td><math>\Phi &gt; 0.50</math></td> <td>0</td> </tr> <tr> <td><b>Total</b></td> <td>5</td> </tr> </tbody> </table> <p>6.2 Line type( Non-display or display ) :</p> <table border="1"> <thead> <tr> <th rowspan="2">Length (L)</th> <th rowspan="2">Width (W)</th> <th colspan="2">Acceptance (Q'ty)</th> </tr> <tr> <th>A area</th> <th>B area</th> </tr> </thead> <tbody> <tr> <td>--</td> <td><math>W \leq 0.03</math></td> <td colspan="2">Ignore</td> </tr> <tr> <td><math>L \leq 10.0</math></td> <td><math>0.03 &lt; W \leq 0.05</math></td> <td>4</td> <td rowspan="3">Ignore</td> </tr> <tr> <td><math>L \leq 5.0</math></td> <td><math>0.05 &lt; W \leq 0.10</math></td> <td>2</td> </tr> <tr> <td>--</td> <td><math>W &gt; 0.10</math></td> <td colspan="2">As round type</td> </tr> <tr> <td colspan="2"><b>Total</b></td> <td>5</td> <td></td> </tr> </tbody> </table>	Dimension (diameter : $\Phi$ )	Acceptance (Q'ty)		A area	B area	$\Phi \leq 0.25$	Ignore		$0.25 < \Phi \leq 0.50$	5	Ignore	$\Phi > 0.50$	0	<b>Total</b>	5	Length (L)	Width (W)	Acceptance (Q'ty)		A area	B area	--	$W \leq 0.03$	Ignore		$L \leq 10.0$	$0.03 < W \leq 0.05$	4	Ignore	$L \leq 5.0$	$0.05 < W \leq 0.10$	2	--	$W > 0.10$	As round type		<b>Total</b>		5		Minor
Dimension (diameter : $\Phi$ )	Acceptance (Q'ty)																																										
	A area	B area																																									
$\Phi \leq 0.25$	Ignore																																										
$0.25 < \Phi \leq 0.50$	5	Ignore																																									
$\Phi > 0.50$	0																																										
<b>Total</b>	5																																										
Length (L)	Width (W)	Acceptance (Q'ty)																																									
		A area	B area																																								
--	$W \leq 0.03$	Ignore																																									
$L \leq 10.0$	$0.03 < W \leq 0.05$	4	Ignore																																								
$L \leq 5.0$	$0.05 < W \leq 0.10$	2																																									
--	$W > 0.10$	As round type																																									
<b>Total</b>		5																																									
07	<p>Polarizer Bubble</p>	<table border="1"> <thead> <tr> <th rowspan="2">Dimension (diameter : <math>\Phi</math>)</th> <th colspan="2">Acceptance (Q'ty)</th> </tr> <tr> <th>A area</th> <th>B area</th> </tr> </thead> <tbody> <tr> <td><math>\Phi \leq 0.25</math></td> <td colspan="2">Ignore</td> </tr> <tr> <td><math>0.25 &lt; \Phi \leq 0.50</math></td> <td>4</td> <td rowspan="3">Ignore</td> </tr> <tr> <td><math>0.50 &lt; \Phi \leq 0.80</math></td> <td>1</td> </tr> <tr> <td><math>\Phi &gt; 0.80</math></td> <td>0</td> </tr> <tr> <td><b>Total</b></td> <td>5</td> <td></td> </tr> </tbody> </table>	Dimension (diameter : $\Phi$ )	Acceptance (Q'ty)		A area	B area	$\Phi \leq 0.25$	Ignore		$0.25 < \Phi \leq 0.50$	4	Ignore	$0.50 < \Phi \leq 0.80$	1	$\Phi > 0.80$	0	<b>Total</b>	5		Minor																						
Dimension (diameter : $\Phi$ )	Acceptance (Q'ty)																																										
	A area	B area																																									
$\Phi \leq 0.25$	Ignore																																										
$0.25 < \Phi \leq 0.50$	4	Ignore																																									
$0.50 < \Phi \leq 0.80$	1																																										
$\Phi > 0.80$	0																																										
<b>Total</b>	5																																										

**◆ Specification For TFT-LCD Module 3.5" ~10" :**

(Ver.B01)

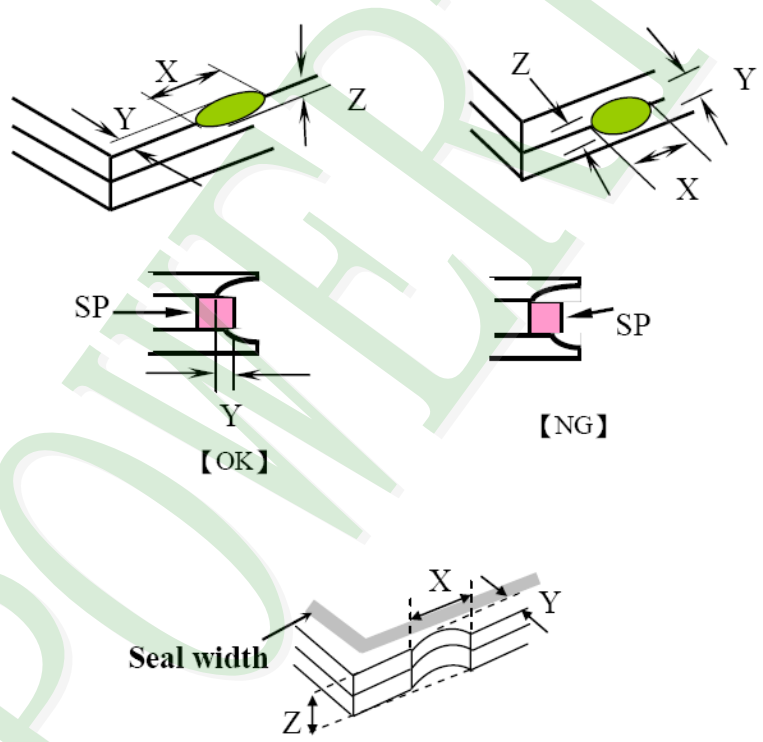
NO	Item	Criterion	Level									
08	The crack of glass	<p><b>Symbols :</b></p> <p><b>X : The length of crack</b>  <b>Z : The thickness of crack</b>  <b>t : The thickness of glass</b></p> <p><b>Y : The width of crack.</b>  <b>W : terminal length</b>  <b>a : LCD side length</b></p> <hr/> <p>8.1 General glass chip :                      8.1.1 Chip on panel surface and crack between panels:</p>  <table border="1" data-bbox="542 1545 1340 1836"> <thead> <tr> <th>X</th> <th>Y</th> <th>Z</th> </tr> </thead> <tbody> <tr> <td><math>\leq a</math></td> <td>Crack can't enter viewing area</td> <td><math>\leq 1/2 t</math></td> </tr> <tr> <td><math>\leq a</math></td> <td>Crack can't exceed the half of SP width.</td> <td><math>1/2 t &lt; Z \leq 2 t</math></td> </tr> </tbody> </table>	X	Y	Z	$\leq a$	Crack can't enter viewing area	$\leq 1/2 t$	$\leq a$	Crack can't exceed the half of SP width.	$1/2 t < Z \leq 2 t$	Minor
X	Y	Z										
$\leq a$	Crack can't enter viewing area	$\leq 1/2 t$										
$\leq a$	Crack can't exceed the half of SP width.	$1/2 t < Z \leq 2 t$										

**◆ Specification For TFT-LCD Module 3.5" ~10" :**

(Ver.B01)

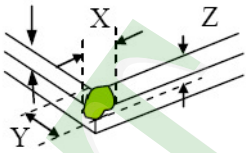
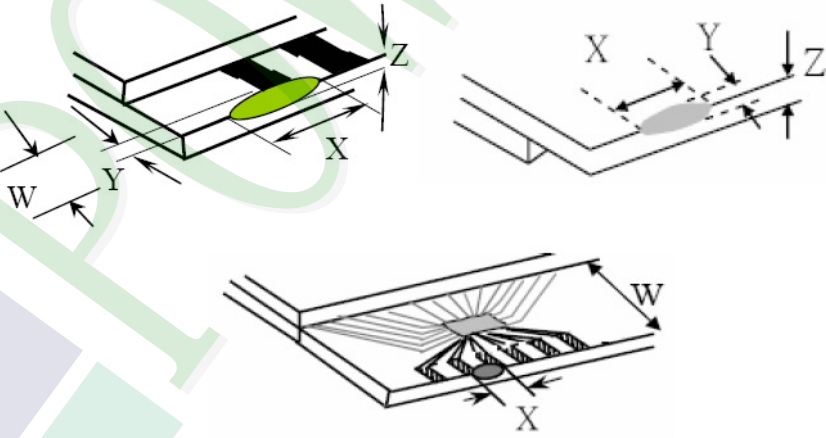
NO	Item	Criterion	Level										
08	The crack of glass	<p><b>Symbols :</b></p> <p><b>X :</b> The length of crack  <b>Z :</b> The thickness of crack  <b>t :</b> The thickness of glass</p> <p><b>Y :</b> The width of crack.  <b>W :</b> terminal length  <b>a :</b> LCD side length</p> <hr/> <p>8.1.2 Corner crack :</p>  <table border="1" data-bbox="525 757 1334 1048"> <thead> <tr> <th>X</th> <th>Y</th> <th>Z</th> </tr> </thead> <tbody> <tr> <td><math>\leq 1/5 a</math></td> <td>Crack can't enter viewing area</td> <td><math>Z \leq 1/2 t</math></td> </tr> <tr> <td><math>\leq 1/5 a</math></td> <td>Crack can't exceed the half of SP width.</td> <td><math>1/2 t &lt; Z \leq 2 t</math></td> </tr> </tbody> </table>	X	Y	Z	$\leq 1/5 a$	Crack can't enter viewing area	$Z \leq 1/2 t$	$\leq 1/5 a$	Crack can't exceed the half of SP width.	$1/2 t < Z \leq 2 t$		
		X	Y	Z									
$\leq 1/5 a$	Crack can't enter viewing area	$Z \leq 1/2 t$											
$\leq 1/5 a$	Crack can't exceed the half of SP width.	$1/2 t < Z \leq 2 t$											
<p>8.2 Protrusion over terminal :</p> <p>8.2.1 Chip on electrode pad :</p>  <table border="1" data-bbox="563 1680 1343 1850"> <thead> <tr> <th></th> <th>X</th> <th>Y</th> <th>Z</th> </tr> </thead> <tbody> <tr> <td><b>Front</b></td> <td><math>\leq a</math></td> <td><math>\leq 1/2 W</math></td> <td><math>\leq t</math></td> </tr> <tr> <td><b>Back</b></td> <td><math>\leq a</math></td> <td><math>\leq W</math></td> <td><math>\leq 1/2 t</math></td> </tr> </tbody> </table>		X	Y	Z	<b>Front</b>	$\leq a$	$\leq 1/2 W$	$\leq t$	<b>Back</b>	$\leq a$	$\leq W$	$\leq 1/2 t$	Minor
	X	Y	Z										
<b>Front</b>	$\leq a$	$\leq 1/2 W$	$\leq t$										
<b>Back</b>	$\leq a$	$\leq W$	$\leq 1/2 t$										



**◆ Specification For TFT-LCD Module 3.5" ~10" :**

(Ver.B01)

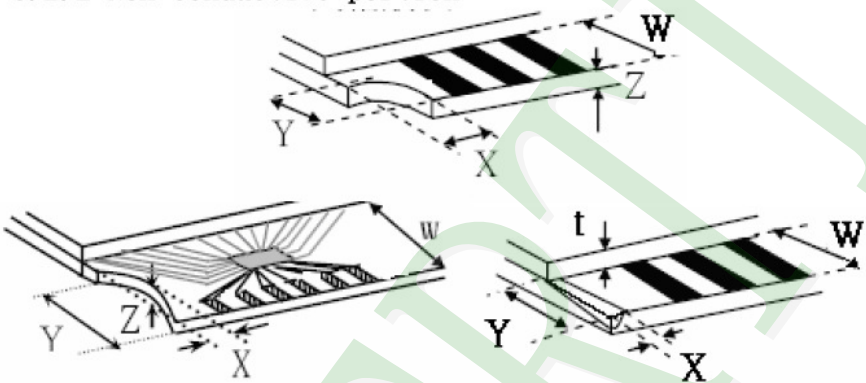
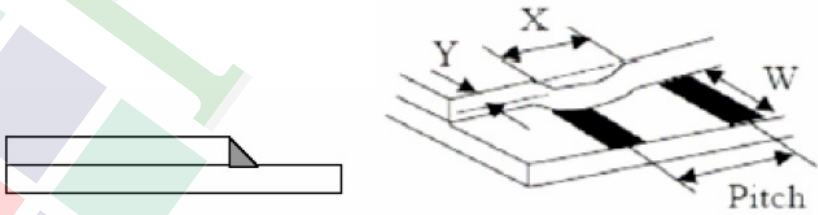
NO	Item	Criterion	Level						
08	The crack of glass	<p><b>Symbols :</b></p> <p><b>X : The length of crack</b>                      <b>Y : The width of crack.</b>  <b>Z : The thickness of crack</b>                <b>W : terminal length</b>  <b>t : The thickness of glass</b>                 <b>a : LCD side length</b></p> <p>8.2.2 Non-conductive portion :</p>  <table border="1" data-bbox="630 963 1260 1120"> <thead> <tr> <th>X</th> <th>Y</th> <th>Z</th> </tr> </thead> <tbody> <tr> <td><math>\leq 1/3 a</math></td> <td><math>\leq W</math></td> <td><math>\leq t</math></td> </tr> </tbody> </table> <p>⊙ If the chipped area touches the ITO terminal, over 2/3 of the ITO must remain and be inspected according to electrode terminal specifications.</p>	X	Y	Z	$\leq 1/3 a$	$\leq W$	$\leq t$	Minor
		X	Y	Z					
$\leq 1/3 a$	$\leq W$	$\leq t$							
<p>8.2.3 Glass remain :</p>  <table border="1" data-bbox="550 1736 1244 1881"> <thead> <tr> <th>X</th> <th>Y</th> <th>Z</th> </tr> </thead> <tbody> <tr> <td><math>\leq a</math></td> <td><math>\leq 1/3 W</math></td> <td><math>\leq t</math></td> </tr> </tbody> </table>	X	Y	Z	$\leq a$	$\leq 1/3 W$	$\leq t$			
X	Y	Z							
$\leq a$	$\leq 1/3 W$	$\leq t$							





## 5. PRECAUTION RELATING PRODUCT HANDLING

### 5.1 SAFETY

- 5.1.1 If the LCD panel breaks , be careful not to get the liquid crystal to touch your skin.
- 5.1.2 If the liquid crystal touches your skin or clothes , please wash it off immediately by using soap and water.

### 5.2 HANDLING

- 5.2.1 Avoid any strong mechanical shock which can break the glass.
- 5.2.2 Avoid static electricity which can damage the CMOS LSI—When working with the module , be sure to ground your body and any electrical equipment you may be using.
- 5.2.3 Do not remove the panel or frame from the module.
- 5.2.4 The polarizing plate of the display is very fragile. So , please handle it very carefully ,do not touch , push or rub the exposed polarizing with anything harder than an HB pencil lead (glass , tweezers , etc.)
- 5.2.5 Do not wipe the polarizing plate with a dry cloth , as it may easily scratch the surface of plate.
- 5.2.6 Do not touch the display area with bare hands , this will stain the display area.
- 5.2.7 Do not use ketonics solvent & aromatic solvent. Use with a soft cloth soaked with a cleaning naphtha solvent.
- 5.2.8 To control temperature and time of soldering is  $320\pm 10^{\circ}\text{C}$  and 3-5 sec.
- 5.2.9 To avoid liquid (include organic solvent) stained on LCM .

### 5.3 STORAGE

- 5.3.1 Store the panel or module in a dark place where the temperature is  $25^{\circ}\text{C} \pm 5^{\circ}\text{C}$  and the humidity is below 65% RH.
- 5.3.2 Do not place the module near organics solvents or corrosive gases.
- 5.3.3 Do not crush , shake , or jolt the module.

### 5.4 TERMS OF WARRANTY

#### 5.4.1 Applicable warrant period

The period is within thirteen months since the date of shipping out under normal using and storage conditions.

#### 5.4.2 Unaccepted responsibility

This product has been manufactured to your company's specification as a part for use in your company's general electronic products. It is guaranteed to perform according to delivery specifications. For any other use apart from general electronic equipment , we cannot take responsibility if the product is used in nuclear power control equipment , aerospace equipment , fire and security systems or any other applications in which there is a direct risk to human life and where extremely high levels of reliability are required.



Approve	Check	Contact
Oliver	Stone	Kevin

### 1. 包裝材料規格表 (Packaging Material) : (per carton)

No.	Item	Model	Dimensions (mm)	1Pcs Weight	Quantity	Total Weight
1	成品 (LCD)	PH800480T013-IHC03	186.8 X 110.56	0.1679	48	8.059
2	多層薄膜(1)POF	OTFILM0BA03ABA	—————	—————	6	—————
3	TRAY 盤 (2)Tray	TY00000000397	352 X 260 X 16.8	0.1	30	3.0
4	內盒(3)Product Box	BX36627063ABBA	383 X 270 X 66	0.2692	6	1.6152
5	保利龍板(4)Polylon board	OTPLB00PL08ABA	550 X 393 X 20	0.0284	2	0.0568
6	外紙箱(5)Carton	BX57041027CCBA	570 X 410 X 265	1.4208	1	1.4208
7						
8						
9						

2. 一整箱總重量 (Total LCD Weight in carton) : 14.15 Kg±10%

3. 單箱數量規格表 (Packaging Specifications and Quantity) :

(1)LCD quantity per box : no per tray	2	x no of tray	4	=	8
(2)Total LCD quantity in carton : quantity per box	8	x no of boxes	6	=	48

Use empty tray  
空盤

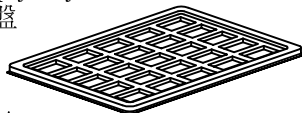

+

(1)多層薄膜  
POF

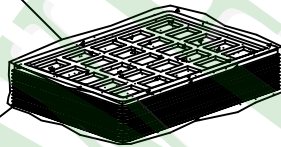

(4)保利龍板  
Polylon board

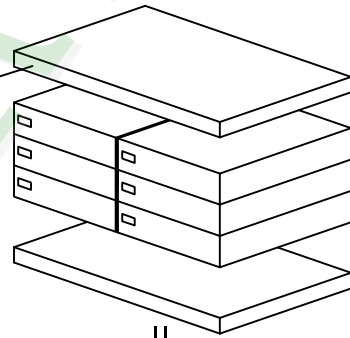

Put products into the tray

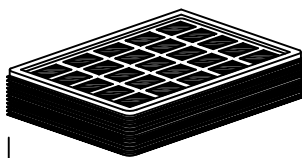

(2)TRAY 盤  
Tray

↓

Tray stacking

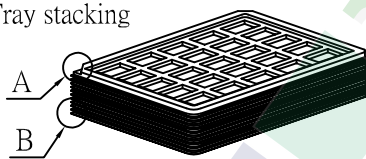

(3)內盒  
Product Box

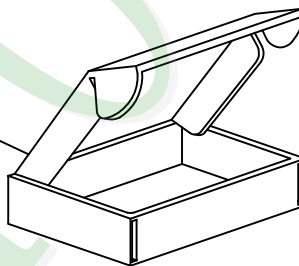

(5)外紙箱  
Carton

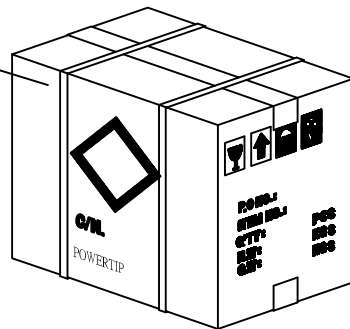

### 特 記 事 項 (REMARK)

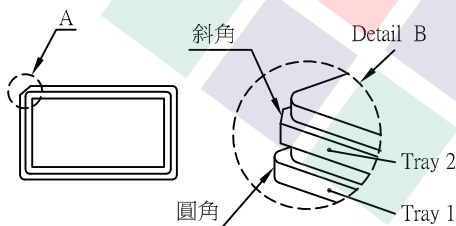

5. TRAY盤相疊時,需旋轉180度,請詳見B視圖  
Rotate tray 180 degrees and place on top of stack.  
Check the tray stack using Fig. B.