



Preliminary Specifications

Final Specifications

<b>Module</b>	15.6 Inch Color TFT-LCD
<b>Model Name</b>	G156HAB01.0
<b>Note</b>	oTP display

<b>Customer</b>	<b>Date</b>
<b>Checked &amp; Approved by</b>	
_____	_____
Customer's sign back page	

<b>Approved by</b>	<b>Date</b>
<u>Sean Lin</u>	<u>2019/01/19</u>
<b>Prepared by</b>	
<u>Ch Tsai</u>	<u>2019/01/18</u>
General Display Business Unit / AU Optronics corporation	

AUO-General

## Contents

<b>1. Operating Precautions</b> .....	<b>4</b>
<b>2. General Description</b> .....	<b>5</b>
2.1 General Characteristics.....	5
2.2 Touch Characteristics.....	6
2.3 Optical Characteristics .....	6
<b>3. Functional Block Diagram</b> .....	<b>10</b>
<b>4. Absolute Maximum Ratings</b> .....	<b>11</b>
4.1 Absolute Ratings of TFT LCD Module.....	11
4.2 Absolute Ratings of Touch Sensor Module.....	11
4.3 Absolute Ratings of Environment .....	11
<b>5. Electrical Characteristics</b> .....	<b>12</b>
5.1 TFT LCD Module.....	12
5.2 Backlight Unit .....	15
5.3 Touch Sensor Module .....	15
<b>6. Signal Characteristic</b> .....	<b>16</b>
6.1 Pixel Format Image .....	16
6.2 Scanning Direction .....	16
6.3 Signal Description .....	17
6.4 Interface Timing .....	19
6.5 Power ON/OFF Sequence .....	21
<b>Touch Power on Sequence:</b> .....	<b>23</b>
<b>7. Reliability Test Criteria</b> .....	<b>24</b>
7.1 Vibration Test .....	24
7.2 Shock Test .....	24
7.3 Reliability Test .....	24
<b>8. Mechanical Characteristics</b> .....	<b>25</b>
8.1 LCM Outline Dimension (Front View and back view) .....	25
<b>9. Label and Packaging</b> .....	<b>27</b>
9.1 Shipping Label (on the rear side of TFT-LCD display) .....	27
9.2 Carton Package .....	27
9.3 Shipping Package of Palletizing Sequence .....	29
<b>10. Safety</b> .....	<b>30</b>
10.1 Sharp Edge Requirements.....	30
10.2 Materials .....	30
10.3 Capacitors.....	30
10.4 National Test Lab Requirement.....	30

# Record of Revision

Version	Date (yyyy/m/d)	Page	Old description	New Description																																																																																																																														
0.1	2018/04/30	All	First Edition																																																																																																																															
0.2	2018/04/30	6	TPIC=Ilitek 2315	TPIC=EETI 3200																																																																																																																														
		6		Correct OD for cover lens																																																																																																																														
0.3	2018/07/19	17		Correct connector & pin assignment Description																																																																																																																														
1.0	2019/01/18	5	<table border="1"> <thead> <tr> <th>Items</th> <th>Unit</th> <th>Specifications</th> </tr> </thead> <tbody> <tr><td>Screen Diameter</td><td>[mm]</td><td>156.0</td></tr> <tr><td>Active Area</td><td>[mm]</td><td>146.0 x 81.0</td></tr> <tr><td>Pixel Pitch</td><td>[mm]</td><td>0.282 x 0.282</td></tr> <tr><td>Resolution</td><td>[mm]</td><td>518 x 288</td></tr> <tr><td>Display Mode</td><td></td><td>Normal Mode</td></tr> <tr><td>Response Time</td><td>[ms]</td><td>20.0</td></tr> <tr><td>Normal Input Voltage (VDD)</td><td>[V]</td><td>1.2</td></tr> <tr><td>Power Consumption</td><td>[W]</td><td>1.0</td></tr> <tr><td>Weight</td><td>[g]</td><td>100</td></tr> <tr><td>Physical Size</td><td></td><td>Length: 156.0mm, Width: 81.0mm, Thickness: 2.0mm</td></tr> <tr><td>Material</td><td></td><td>Aluminum</td></tr> <tr><td>Electrostatic Protection</td><td></td><td>ESD Protection</td></tr> <tr><td>Surface Treatment (Coating)</td><td></td><td>None</td></tr> <tr><td>Surface Treatment (Coating)</td><td></td><td>None</td></tr> <tr><td>Surface Treatment (Coating)</td><td></td><td>None</td></tr> <tr><td>Temperature Range</td><td>[°C]</td><td>-20 to 60</td></tr> <tr><td>Humidity</td><td>[%RH]</td><td>20 to 80</td></tr> <tr><td>Shock Resistance</td><td>[g]</td><td>100</td></tr> <tr><td>Vibration Resistance</td><td>[g]</td><td>100</td></tr> <tr><td>RoHS Compliance</td><td></td><td>RoHS Compliance</td></tr> </tbody> </table>	Items	Unit	Specifications	Screen Diameter	[mm]	156.0	Active Area	[mm]	146.0 x 81.0	Pixel Pitch	[mm]	0.282 x 0.282	Resolution	[mm]	518 x 288	Display Mode		Normal Mode	Response Time	[ms]	20.0	Normal Input Voltage (VDD)	[V]	1.2	Power Consumption	[W]	1.0	Weight	[g]	100	Physical Size		Length: 156.0mm, Width: 81.0mm, Thickness: 2.0mm	Material		Aluminum	Electrostatic Protection		ESD Protection	Surface Treatment (Coating)		None	Surface Treatment (Coating)		None	Surface Treatment (Coating)		None	Temperature Range	[°C]	-20 to 60	Humidity	[%RH]	20 to 80	Shock Resistance	[g]	100	Vibration Resistance	[g]	100	RoHS Compliance		RoHS Compliance	<table border="1"> <thead> <tr> <th>Items</th> <th>Unit</th> <th>Specifications</th> </tr> </thead> <tbody> <tr><td>Screen Diameter</td><td>[mm]</td><td>156.0</td></tr> <tr><td>Active Area</td><td>[mm]</td><td>146.0 x 81.0</td></tr> <tr><td>Pixel Pitch</td><td>[mm]</td><td>0.282 x 0.282</td></tr> <tr><td>Resolution</td><td>[mm]</td><td>518 x 288</td></tr> <tr><td>Display Mode</td><td></td><td>Normal Mode</td></tr> <tr><td>Response Time</td><td>[ms]</td><td>20.0</td></tr> <tr><td>Normal Input Voltage (VDD)</td><td>[V]</td><td>1.2</td></tr> <tr><td>Power Consumption</td><td>[W]</td><td>1.0</td></tr> <tr><td>Weight</td><td>[g]</td><td>100</td></tr> <tr><td>Physical Size</td><td></td><td>Length: 156.0mm, Width: 81.0mm, Thickness: 2.0mm</td></tr> <tr><td>Material</td><td></td><td>Aluminum</td></tr> <tr><td>Electrostatic Protection</td><td></td><td>ESD Protection</td></tr> <tr><td>Surface Treatment (Coating)</td><td></td><td>None</td></tr> <tr><td>Surface Treatment (Coating)</td><td></td><td>None</td></tr> <tr><td>Surface Treatment (Coating)</td><td></td><td>None</td></tr> <tr><td>Temperature Range</td><td>[°C]</td><td>-20 to 60</td></tr> <tr><td>Humidity</td><td>[%RH]</td><td>20 to 80</td></tr> <tr><td>Shock Resistance</td><td>[g]</td><td>100</td></tr> <tr><td>Vibration Resistance</td><td>[g]</td><td>100</td></tr> <tr><td>RoHS Compliance</td><td></td><td>RoHS Compliance</td></tr> </tbody> </table>	Items	Unit	Specifications	Screen Diameter	[mm]	156.0	Active Area	[mm]	146.0 x 81.0	Pixel Pitch	[mm]	0.282 x 0.282	Resolution	[mm]	518 x 288	Display Mode		Normal Mode	Response Time	[ms]	20.0	Normal Input Voltage (VDD)	[V]	1.2	Power Consumption	[W]	1.0	Weight	[g]	100	Physical Size		Length: 156.0mm, Width: 81.0mm, Thickness: 2.0mm	Material		Aluminum	Electrostatic Protection		ESD Protection	Surface Treatment (Coating)		None	Surface Treatment (Coating)		None	Surface Treatment (Coating)		None	Temperature Range	[°C]	-20 to 60	Humidity	[%RH]	20 to 80	Shock Resistance	[g]	100	Vibration Resistance	[g]	100	RoHS Compliance		RoHS Compliance
		Items	Unit	Specifications																																																																																																																														
		Screen Diameter	[mm]	156.0																																																																																																																														
		Active Area	[mm]	146.0 x 81.0																																																																																																																														
Pixel Pitch	[mm]	0.282 x 0.282																																																																																																																																
Resolution	[mm]	518 x 288																																																																																																																																
Display Mode		Normal Mode																																																																																																																																
Response Time	[ms]	20.0																																																																																																																																
Normal Input Voltage (VDD)	[V]	1.2																																																																																																																																
Power Consumption	[W]	1.0																																																																																																																																
Weight	[g]	100																																																																																																																																
Physical Size		Length: 156.0mm, Width: 81.0mm, Thickness: 2.0mm																																																																																																																																
Material		Aluminum																																																																																																																																
Electrostatic Protection		ESD Protection																																																																																																																																
Surface Treatment (Coating)		None																																																																																																																																
Surface Treatment (Coating)		None																																																																																																																																
Surface Treatment (Coating)		None																																																																																																																																
Temperature Range	[°C]	-20 to 60																																																																																																																																
Humidity	[%RH]	20 to 80																																																																																																																																
Shock Resistance	[g]	100																																																																																																																																
Vibration Resistance	[g]	100																																																																																																																																
RoHS Compliance		RoHS Compliance																																																																																																																																
Items	Unit	Specifications																																																																																																																																
Screen Diameter	[mm]	156.0																																																																																																																																
Active Area	[mm]	146.0 x 81.0																																																																																																																																
Pixel Pitch	[mm]	0.282 x 0.282																																																																																																																																
Resolution	[mm]	518 x 288																																																																																																																																
Display Mode		Normal Mode																																																																																																																																
Response Time	[ms]	20.0																																																																																																																																
Normal Input Voltage (VDD)	[V]	1.2																																																																																																																																
Power Consumption	[W]	1.0																																																																																																																																
Weight	[g]	100																																																																																																																																
Physical Size		Length: 156.0mm, Width: 81.0mm, Thickness: 2.0mm																																																																																																																																
Material		Aluminum																																																																																																																																
Electrostatic Protection		ESD Protection																																																																																																																																
Surface Treatment (Coating)		None																																																																																																																																
Surface Treatment (Coating)		None																																																																																																																																
Surface Treatment (Coating)		None																																																																																																																																
Temperature Range	[°C]	-20 to 60																																																																																																																																
Humidity	[%RH]	20 to 80																																																																																																																																
Shock Resistance	[g]	100																																																																																																																																
Vibration Resistance	[g]	100																																																																																																																																
RoHS Compliance		RoHS Compliance																																																																																																																																
		7	<table border="1"> <thead> <tr> <th>Items</th> <th>Unit</th> <th>Specifications</th> </tr> </thead> <tbody> <tr><td>Screen Diameter</td><td>[mm]</td><td>156.0</td></tr> <tr><td>Active Area</td><td>[mm]</td><td>146.0 x 81.0</td></tr> <tr><td>Pixel Pitch</td><td>[mm]</td><td>0.282 x 0.282</td></tr> <tr><td>Resolution</td><td>[mm]</td><td>518 x 288</td></tr> <tr><td>Display Mode</td><td></td><td>Normal Mode</td></tr> <tr><td>Response Time</td><td>[ms]</td><td>20.0</td></tr> <tr><td>Normal Input Voltage (VDD)</td><td>[V]</td><td>1.2</td></tr> <tr><td>Power Consumption</td><td>[W]</td><td>1.0</td></tr> <tr><td>Weight</td><td>[g]</td><td>100</td></tr> <tr><td>Physical Size</td><td></td><td>Length: 156.0mm, Width: 81.0mm, Thickness: 2.0mm</td></tr> <tr><td>Material</td><td></td><td>Aluminum</td></tr> <tr><td>Electrostatic Protection</td><td></td><td>ESD Protection</td></tr> <tr><td>Surface Treatment (Coating)</td><td></td><td>None</td></tr> <tr><td>Surface Treatment (Coating)</td><td></td><td>None</td></tr> <tr><td>Surface Treatment (Coating)</td><td></td><td>None</td></tr> <tr><td>Temperature Range</td><td>[°C]</td><td>-20 to 60</td></tr> <tr><td>Humidity</td><td>[%RH]</td><td>20 to 80</td></tr> <tr><td>Shock Resistance</td><td>[g]</td><td>100</td></tr> <tr><td>Vibration Resistance</td><td>[g]</td><td>100</td></tr> <tr><td>RoHS Compliance</td><td></td><td>RoHS Compliance</td></tr> </tbody> </table>	Items	Unit	Specifications	Screen Diameter	[mm]	156.0	Active Area	[mm]	146.0 x 81.0	Pixel Pitch	[mm]	0.282 x 0.282	Resolution	[mm]	518 x 288	Display Mode		Normal Mode	Response Time	[ms]	20.0	Normal Input Voltage (VDD)	[V]	1.2	Power Consumption	[W]	1.0	Weight	[g]	100	Physical Size		Length: 156.0mm, Width: 81.0mm, Thickness: 2.0mm	Material		Aluminum	Electrostatic Protection		ESD Protection	Surface Treatment (Coating)		None	Surface Treatment (Coating)		None	Surface Treatment (Coating)		None	Temperature Range	[°C]	-20 to 60	Humidity	[%RH]	20 to 80	Shock Resistance	[g]	100	Vibration Resistance	[g]	100	RoHS Compliance		RoHS Compliance	<table border="1"> <thead> <tr> <th>Items</th> <th>Unit</th> <th>Specifications</th> </tr> </thead> <tbody> <tr><td>Screen Diameter</td><td>[mm]</td><td>156.0</td></tr> <tr><td>Active Area</td><td>[mm]</td><td>146.0 x 81.0</td></tr> <tr><td>Pixel Pitch</td><td>[mm]</td><td>0.282 x 0.282</td></tr> <tr><td>Resolution</td><td>[mm]</td><td>518 x 288</td></tr> <tr><td>Display Mode</td><td></td><td>Normal Mode</td></tr> <tr><td>Response Time</td><td>[ms]</td><td>20.0</td></tr> <tr><td>Normal Input Voltage (VDD)</td><td>[V]</td><td>1.2</td></tr> <tr><td>Power Consumption</td><td>[W]</td><td>1.0</td></tr> <tr><td>Weight</td><td>[g]</td><td>100</td></tr> <tr><td>Physical Size</td><td></td><td>Length: 156.0mm, Width: 81.0mm, Thickness: 2.0mm</td></tr> <tr><td>Material</td><td></td><td>Aluminum</td></tr> <tr><td>Electrostatic Protection</td><td></td><td>ESD Protection</td></tr> <tr><td>Surface Treatment (Coating)</td><td></td><td>None</td></tr> <tr><td>Surface Treatment (Coating)</td><td></td><td>None</td></tr> <tr><td>Surface Treatment (Coating)</td><td></td><td>None</td></tr> <tr><td>Temperature Range</td><td>[°C]</td><td>-20 to 60</td></tr> <tr><td>Humidity</td><td>[%RH]</td><td>20 to 80</td></tr> <tr><td>Shock Resistance</td><td>[g]</td><td>100</td></tr> <tr><td>Vibration Resistance</td><td>[g]</td><td>100</td></tr> <tr><td>RoHS Compliance</td><td></td><td>RoHS Compliance</td></tr> </tbody> </table>	Items	Unit	Specifications	Screen Diameter	[mm]	156.0	Active Area	[mm]	146.0 x 81.0	Pixel Pitch	[mm]	0.282 x 0.282	Resolution	[mm]	518 x 288	Display Mode		Normal Mode	Response Time	[ms]	20.0	Normal Input Voltage (VDD)	[V]	1.2	Power Consumption	[W]	1.0	Weight	[g]	100	Physical Size		Length: 156.0mm, Width: 81.0mm, Thickness: 2.0mm	Material		Aluminum	Electrostatic Protection		ESD Protection	Surface Treatment (Coating)		None	Surface Treatment (Coating)		None	Surface Treatment (Coating)		None	Temperature Range	[°C]	-20 to 60	Humidity	[%RH]	20 to 80	Shock Resistance	[g]	100	Vibration Resistance	[g]	100	RoHS Compliance		RoHS Compliance
Items	Unit	Specifications																																																																																																																																
Screen Diameter	[mm]	156.0																																																																																																																																
Active Area	[mm]	146.0 x 81.0																																																																																																																																
Pixel Pitch	[mm]	0.282 x 0.282																																																																																																																																
Resolution	[mm]	518 x 288																																																																																																																																
Display Mode		Normal Mode																																																																																																																																
Response Time	[ms]	20.0																																																																																																																																
Normal Input Voltage (VDD)	[V]	1.2																																																																																																																																
Power Consumption	[W]	1.0																																																																																																																																
Weight	[g]	100																																																																																																																																
Physical Size		Length: 156.0mm, Width: 81.0mm, Thickness: 2.0mm																																																																																																																																
Material		Aluminum																																																																																																																																
Electrostatic Protection		ESD Protection																																																																																																																																
Surface Treatment (Coating)		None																																																																																																																																
Surface Treatment (Coating)		None																																																																																																																																
Surface Treatment (Coating)		None																																																																																																																																
Temperature Range	[°C]	-20 to 60																																																																																																																																
Humidity	[%RH]	20 to 80																																																																																																																																
Shock Resistance	[g]	100																																																																																																																																
Vibration Resistance	[g]	100																																																																																																																																
RoHS Compliance		RoHS Compliance																																																																																																																																
Items	Unit	Specifications																																																																																																																																
Screen Diameter	[mm]	156.0																																																																																																																																
Active Area	[mm]	146.0 x 81.0																																																																																																																																
Pixel Pitch	[mm]	0.282 x 0.282																																																																																																																																
Resolution	[mm]	518 x 288																																																																																																																																
Display Mode		Normal Mode																																																																																																																																
Response Time	[ms]	20.0																																																																																																																																
Normal Input Voltage (VDD)	[V]	1.2																																																																																																																																
Power Consumption	[W]	1.0																																																																																																																																
Weight	[g]	100																																																																																																																																
Physical Size		Length: 156.0mm, Width: 81.0mm, Thickness: 2.0mm																																																																																																																																
Material		Aluminum																																																																																																																																
Electrostatic Protection		ESD Protection																																																																																																																																
Surface Treatment (Coating)		None																																																																																																																																
Surface Treatment (Coating)		None																																																																																																																																
Surface Treatment (Coating)		None																																																																																																																																
Temperature Range	[°C]	-20 to 60																																																																																																																																
Humidity	[%RH]	20 to 80																																																																																																																																
Shock Resistance	[g]	100																																																																																																																																
Vibration Resistance	[g]	100																																																																																																																																
RoHS Compliance		RoHS Compliance																																																																																																																																
		11	<table border="1"> <thead> <tr> <th>Item</th> <th>Symbol</th> <th>Min</th> <th>Max</th> <th>Unit</th> </tr> </thead> <tbody> <tr> <td>Touch Sensor Module Power Voltage</td> <td>VDD</td> <td>4.5</td> <td>4.8</td> <td>[V]</td> </tr> <tr> <td>Touch Sensor Module Power Current</td> <td>IDD</td> <td>1.0</td> <td>1.5</td> <td>[mA]</td> </tr> <tr> <td>Touch Sensor Module Power Voltage</td> <td>VDD</td> <td>4.5</td> <td>4.8</td> <td>[V]</td> </tr> <tr> <td>Touch Sensor Module Power Current</td> <td>IDD</td> <td>1.0</td> <td>1.5</td> <td>[mA]</td> </tr> </tbody> </table>	Item	Symbol	Min	Max	Unit	Touch Sensor Module Power Voltage	VDD	4.5	4.8	[V]	Touch Sensor Module Power Current	IDD	1.0	1.5	[mA]	Touch Sensor Module Power Voltage	VDD	4.5	4.8	[V]	Touch Sensor Module Power Current	IDD	1.0	1.5	[mA]	<table border="1"> <thead> <tr> <th>Item</th> <th>Symbol</th> <th>Min</th> <th>Max</th> <th>Unit</th> </tr> </thead> <tbody> <tr> <td>Touch Sensor Module Power Voltage</td> <td>VDD</td> <td>4.5</td> <td>4.8</td> <td>[V]</td> </tr> <tr> <td>Touch Sensor Module Power Current</td> <td>IDD</td> <td>1.0</td> <td>1.5</td> <td>[mA]</td> </tr> <tr> <td>Touch Sensor Module Power Voltage</td> <td>VDD</td> <td>4.5</td> <td>4.8</td> <td>[V]</td> </tr> <tr> <td>Touch Sensor Module Power Current</td> <td>IDD</td> <td>1.0</td> <td>1.5</td> <td>[mA]</td> </tr> </tbody> </table>	Item	Symbol	Min	Max	Unit	Touch Sensor Module Power Voltage	VDD	4.5	4.8	[V]	Touch Sensor Module Power Current	IDD	1.0	1.5	[mA]	Touch Sensor Module Power Voltage	VDD	4.5	4.8	[V]	Touch Sensor Module Power Current	IDD	1.0	1.5	[mA]																																																																												
Item	Symbol	Min	Max	Unit																																																																																																																														
Touch Sensor Module Power Voltage	VDD	4.5	4.8	[V]																																																																																																																														
Touch Sensor Module Power Current	IDD	1.0	1.5	[mA]																																																																																																																														
Touch Sensor Module Power Voltage	VDD	4.5	4.8	[V]																																																																																																																														
Touch Sensor Module Power Current	IDD	1.0	1.5	[mA]																																																																																																																														
Item	Symbol	Min	Max	Unit																																																																																																																														
Touch Sensor Module Power Voltage	VDD	4.5	4.8	[V]																																																																																																																														
Touch Sensor Module Power Current	IDD	1.0	1.5	[mA]																																																																																																																														
Touch Sensor Module Power Voltage	VDD	4.5	4.8	[V]																																																																																																																														
Touch Sensor Module Power Current	IDD	1.0	1.5	[mA]																																																																																																																														
		15	<table border="1"> <thead> <tr> <th>Item</th> <th>Symbol</th> <th>Min</th> <th>Max</th> <th>Unit</th> <th>Note</th> </tr> </thead> <tbody> <tr> <td>Touch sensor module Power Voltage</td> <td>VDD</td> <td>4.5</td> <td>5.0</td> <td>V</td> <td>-</td> </tr> <tr> <td>Touch sensor module Power Consumption</td> <td>IDD</td> <td>-</td> <td>-</td> <td>mA</td> <td>-</td> </tr> <tr> <td>Touch Sensor Module Power Voltage</td> <td>VDD</td> <td>4.5</td> <td>5.0</td> <td>V</td> <td>-</td> </tr> <tr> <td>Touch Sensor Module Power Current</td> <td>IDD</td> <td>-</td> <td>-</td> <td>mA</td> <td>-</td> </tr> </tbody> </table>	Item	Symbol	Min	Max	Unit	Note	Touch sensor module Power Voltage	VDD	4.5	5.0	V	-	Touch sensor module Power Consumption	IDD	-	-	mA	-	Touch Sensor Module Power Voltage	VDD	4.5	5.0	V	-	Touch Sensor Module Power Current	IDD	-	-	mA	-	<table border="1"> <thead> <tr> <th>Item</th> <th>Symbol</th> <th>Min</th> <th>Max</th> <th>Unit</th> <th>Note</th> </tr> </thead> <tbody> <tr> <td>Touch sensor module Power Voltage</td> <td>VDD</td> <td>4.5</td> <td>5.0</td> <td>V</td> <td>-</td> </tr> <tr> <td>Touch sensor module Power Consumption</td> <td>IDD</td> <td>-</td> <td>-</td> <td>mA</td> <td>-</td> </tr> <tr> <td>Touch Sensor Module Power Voltage</td> <td>VDD</td> <td>4.5</td> <td>5.0</td> <td>V</td> <td>-</td> </tr> <tr> <td>Touch Sensor Module Power Current</td> <td>IDD</td> <td>-</td> <td>-</td> <td>mA</td> <td>-</td> </tr> </tbody> </table>	Item	Symbol	Min	Max	Unit	Note	Touch sensor module Power Voltage	VDD	4.5	5.0	V	-	Touch sensor module Power Consumption	IDD	-	-	mA	-	Touch Sensor Module Power Voltage	VDD	4.5	5.0	V	-	Touch Sensor Module Power Current	IDD	-	-	mA	-																																																																		
Item	Symbol	Min	Max	Unit	Note																																																																																																																													
Touch sensor module Power Voltage	VDD	4.5	5.0	V	-																																																																																																																													
Touch sensor module Power Consumption	IDD	-	-	mA	-																																																																																																																													
Touch Sensor Module Power Voltage	VDD	4.5	5.0	V	-																																																																																																																													
Touch Sensor Module Power Current	IDD	-	-	mA	-																																																																																																																													
Item	Symbol	Min	Max	Unit	Note																																																																																																																													
Touch sensor module Power Voltage	VDD	4.5	5.0	V	-																																																																																																																													
Touch sensor module Power Consumption	IDD	-	-	mA	-																																																																																																																													
Touch Sensor Module Power Voltage	VDD	4.5	5.0	V	-																																																																																																																													
Touch Sensor Module Power Current	IDD	-	-	mA	-																																																																																																																													

## 1. Operating Precautions

- 1) Since front polarizer is easily damaged, please be cautious and not to scratch it.
- 2) Be sure to turn off power supply when inserting or disconnecting from input connector.
- 3) Wipe off water drop immediately. Long contact with water may cause discoloration or spots.
- 4) When the panel surface is soiled, wipe it with absorbent cotton or soft cloth.
- 5) Since the panel is made of glass, it may be broken or cracked if dropped or bumped on hard surface.
- 6) Since CMOS LSI is used in this module, take care of static electricity and insure human earth when handling.
- 7) Do not open nor modify the module assembly.
- 8) Do not press the reflector sheet at the back of the module to any direction.
- 9) In case if a module has to be put back into the packing container slot after it was taken out from the container, do not press the center of the LED Reflector edge. Instead, press at the far ends of the LED Reflector edge softly. Otherwise the TFT Module may be damaged.
- 10) At the insertion or removal of the Signal Interface Connector, be sure not to rotate nor tilt the Interface Connector of the TFT Module.
- 11) TFT-LCD Module is not allowed to be twisted & bent even force is added on module in a very short time. Please design your display product well to avoid external force applying to module by end-user directly.
- 12) Small amount of materials without flammability grade are used in the TFT-LCD module. The TFT-LCD module should be supplied by power complied with requirements of Limited Power Source (IEC60950-1 or UL60950-1), or be applied exemption.
- 13) Severe temperature condition may result in different luminance, response time.
- 14) Continuous operating TFT-LCD Module under high temperature environment may accelerate LED light bar exhaustion and reduce luminance dramatically.
- 15) The data on this specification sheet is applicable when TFT-LCD module is placed in landscape position.
- 16) Continuous displaying fixed pattern may induce image sticking. It's recommended to use screen saver or moving content periodically if fixed pattern is displayed on the screen.

## 2. General Description

G156HAB01.0 is a Color Active Matrix Liquid Crystal Display composed of a TFT-LCD display, a driver circuit, and a LED backlight system. The screen format is intended to support 16:9 FHD (1920(H) x 1080(V)) screen and 16.2M colors (RGB 6-bits+FRC) with LED backlight driving circuit. All input signals are eDP (Embedded DisplayPort) interface compatible.

G156HAB01.0 is designed for a display unit of notebook style personal computer and industrial machine.

### 2.1 General Characteristics

The following items are characteristics summary on the table under 25 °C condition:

Items	Unit	Specifications			
Screen Diagonal	[mm]	15.6"			
Active Area	[mm]	344.16 x 193.59			
Pixels H x V		1920x3(RGB) x 1080			
Pixel Pitch	[mm]	0.17925 x 0.17925			
Pixel Format		R.G.B. Vertical Stripe			
Display Mode		Normally Black			
Response Time	[ms]	25 Typ.			
Nominal Input Voltage VDD	[Volt]	+3.3 Typ.			
Power Consumption	[Watt]	5.5W max			
Weight	[Grams]	620g max			
Physical Size Include bracket.	[mm]		Min.	Typ.	Max.
		Length	359	361	363
		Width	225	227	229
		Thickness			4.9
Electrical Interface		2 Lane eDP1.2			
Surface Treatment_LCD		HC			
Surface Treatment_Cover lens		Non surface treatment			
Support Color		16.2M colors ( RGB 6-bit _ FRC )			
Temperature Range Operating Storage (Non-Operating)	[°C] [°C]	0 to +50 -20 to +60			
RoHS Compliance		RoHS Compliance			

AUO-~~General~~

## 2.2 Touch Characteristics

The following items are characteristics summary on the table under 25 °C condition:

Item	Unit	Specifications
Type of Touch Sensor		Projective Capacity Touch (on-cell touch)
Cover Lens	Outline Dimension	[mm] 361 (H) x 227 (V)
	Material	CS Soda-lime
	Thickness	[mm] 1.1
	Visual Area	[mm] 345.55 (H) x 194.98 (V)
Touch Sensor	Outline Dimension	on cell touch
	Thickness	on cell touch
	Active Area	346.36 x 195.79
Touch Controller		EETI 3200
Channel (X * Y)	[ch]	82 (Rx)* 46(Tx)
Interface		USB
Surface Hardness	[H]	7H
Multi-Touch Point	Points	10
Single/Multi-points Accuracy	[mm]	Follow Win10
Linearity	[mm]	Follow Win10
The smallest distance between 2 points	[mm]	Follow Win10
Report Rate		Follow Win10
OS support		Win 7, Win 8, Win10

**Note1.** Driver is required in Win7/8/10 under mouse emulation mode

## 2.3 Optical Characteristics

The optical characteristics are measured under stable conditions at 25°C (Room Temperature):

Item	Unit	Conditions	Min.	Typ.	Max.	Note
White Luminance	[cd/m <sup>2</sup> ]	I <sub>LED</sub> =20mA(center point)	240	300	-	1
Uniformity	%	5 Points	75	80	-	2, 3
Contrast Ratio			-	800	-	4
Response Time	[msec]	Rising				5
		Falling				
		Raising + Falling	-	25	35	
Viewing Angle	[degree]	Horizontal (Right)	-	89	-	6
	[degree]	CR = 10 (Left)	-	89	-	

	[degree]	Vertical	(Upper)	-	89	-
	[degree]	CR = 10	(Lower)	-	89	-
Color / Chromaticity Coordinates (CIE 1931)		Red x		0.534	0.584	0.634
		Red y		0.291	0.341	0.391
		Green x		0.292	0.342	0.392
		Green y		0.535	0.585	0.635
		Blue x		0.110	0.160	0.210
		Blue y		0.080	0.130	0.180
		White x		0.263	0.313	0.363
		White y		0.279	0.329	0.379
Color Gamut	%				45	-

**Note 1:** Measurement method

Equipment Pattern Generator, Power Supply, Digital Voltmeter, Luminance meter (SR\_3 or equivalent)

Aperture 1° with 50cm viewing distance

Test Point Center

Environment < 1 lux

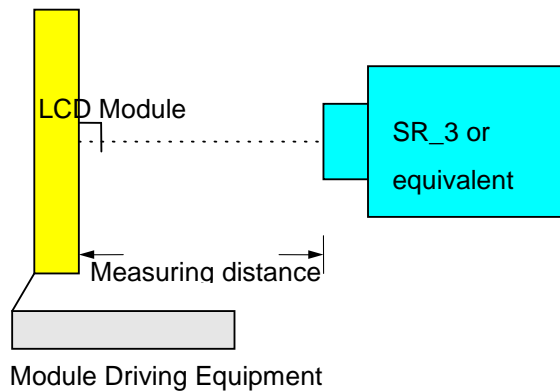

AUO-General

**Note 2:** Definition of 5 points position

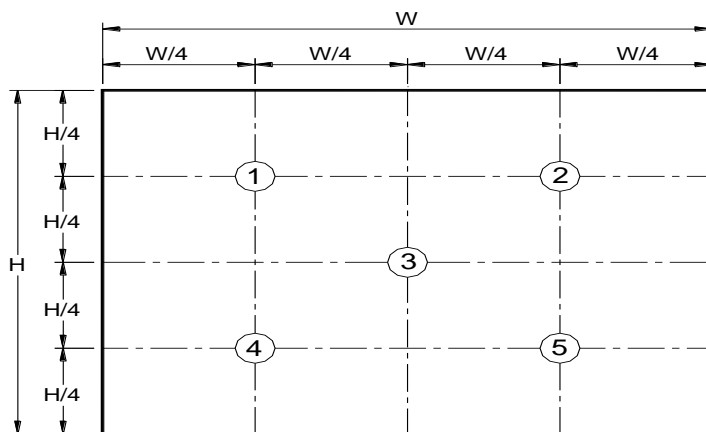

**Note 3:** The luminance uniformity of 5 points is defined by dividing the minimum luminance values by the maximum test point luminance

$$\delta_{w5} = \frac{\text{Minimum Brightness of five points}}{\text{Maximum Brightness of five points}}$$

**Note 4 :** Definition of cross talk (CT)

$$CT = |Y_B - Y_A| / Y_A \times 100 (\%)$$

Where

$Y_A$  = Luminance of measured location without gray level 0 pattern (cd/m<sup>2</sup>)

$Y_B$  = Luminance of measured location with gray level 0 pattern (cd/m<sup>2</sup>)

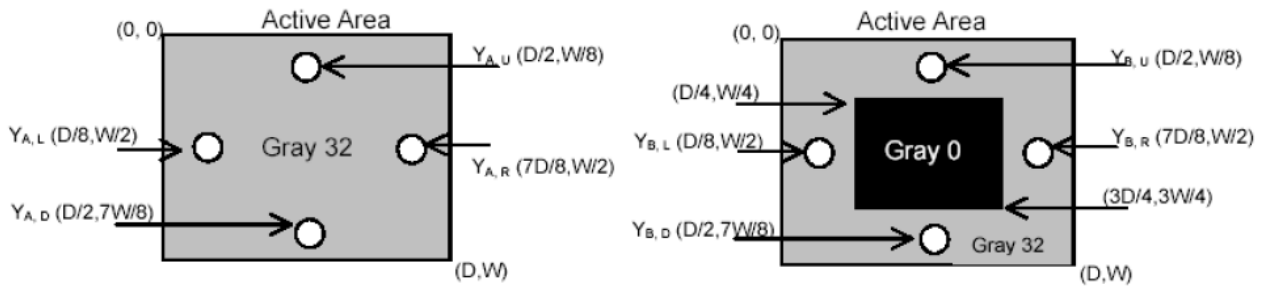

**Note 5:** Definition of response time:

The output signals of photo detector are measured when the input signals are changed from “White” to “Black” (falling time) and from “Black” to “White” (rising time), respectively. The response time interval is between 10% and 90% of amplitudes. Please refer to the figure as below.

AUO-C

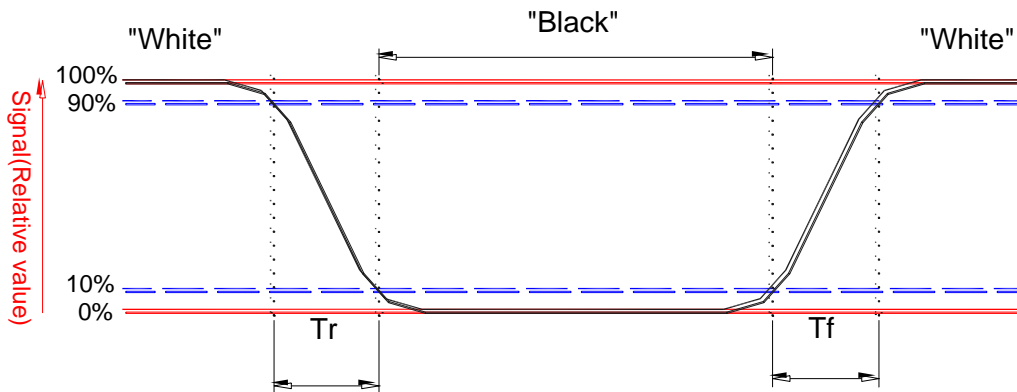



**Note6:** Definition of viewing angle

Viewing angle is the measurement of contrast ratio  $\geq 10$ , at the screen center, over a  $180^\circ$  horizontal and  $180^\circ$  vertical range (off-normal viewing angles). The  $180^\circ$  viewing angle range is broken down as below:  $90^\circ$  ( $\theta$ ) horizontal left and right, and  $90^\circ$  ( $\Phi$ ) vertical high (up) and low (down). The measurement direction is typically perpendicular to the display surface with the screen rotated to its center to develop the desired measurement viewing angle.

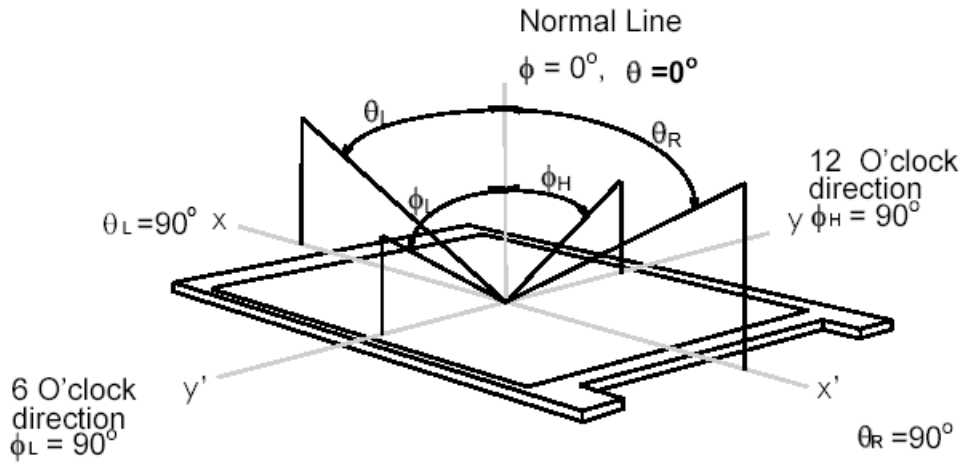

### 3. Functional Block Diagram

The following diagram shows the functional block of the 15.6 inch color TFT/LCD module:

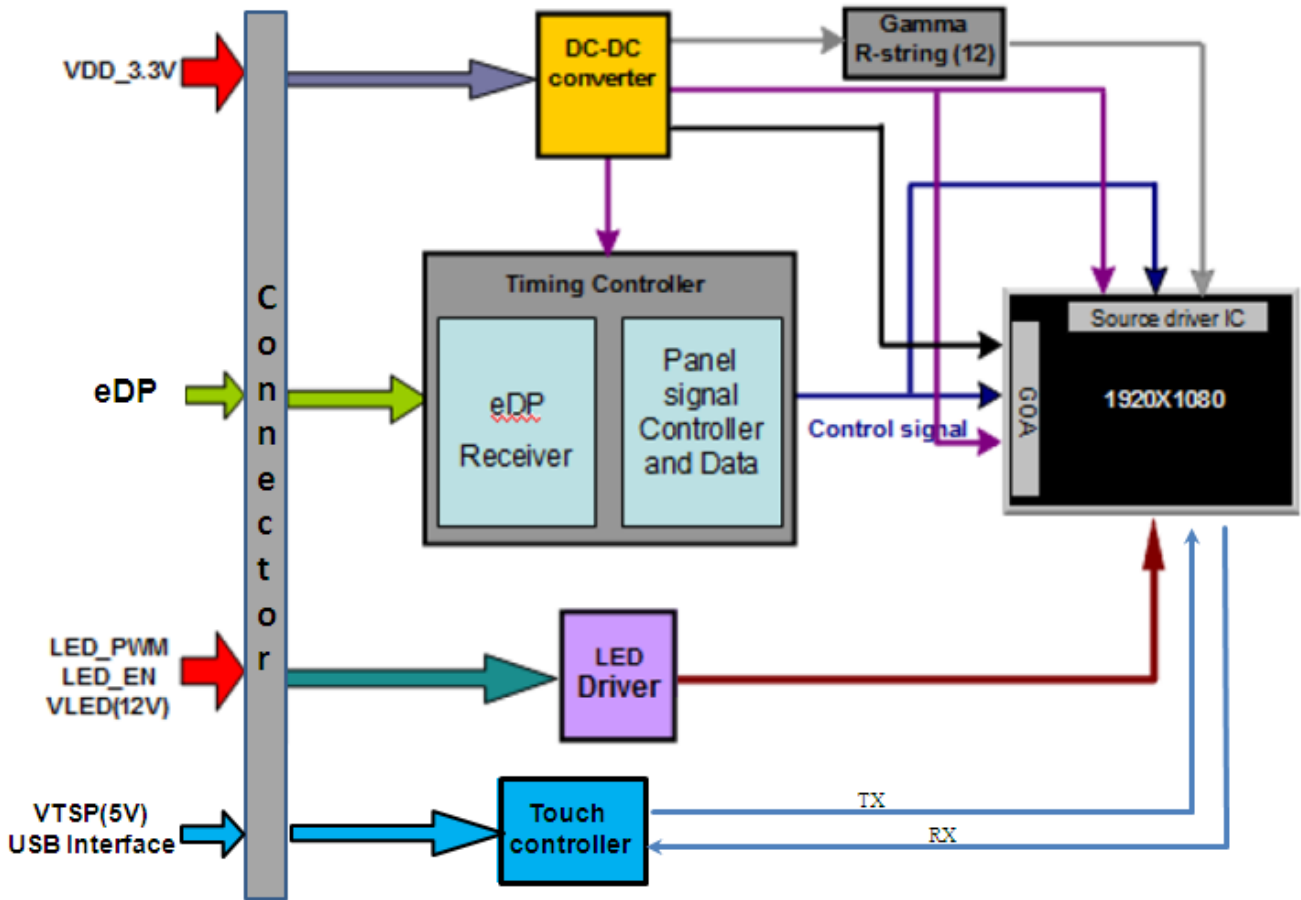

## 4. Absolute Maximum Ratings

### 4.1 Absolute Ratings of TFT LCD Module

Item	Symbol	Min	Max	Unit
Logic/LCD Drive Voltage	Vin	-0.3	+4.0	[Volt]

### 4.2 Absolute Ratings of Touch Sensor Module

Item	Symbol	Min	Max	Unit
Touch Sensor Module Power Voltage	VTSP	-0.3	7.0	[Volt]

### 4.3 Absolute Ratings of Environment

Item	Symbol	Min	Max	Unit
Operating Temperature	TOP	0	+50	[°C]
Operation Humidity	HOP	5	95	[%RH]
Storage Temperature	TST	-20	+60	[°C]
Storage Humidity	HST	5	95	[%RH]

Note: Maximum Wet-Bulb should be 39°C and no condensation.

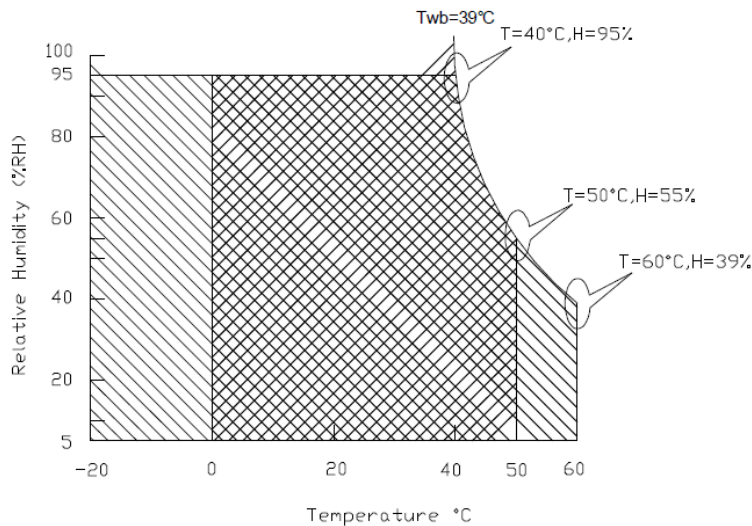

AU

Operating Range

Storage Range

+

## 5. Electrical Characteristics

### 5.1 TFT LCD Module

#### 5.1.1 Power Specification

Input power specifications are as follows;

The power specification are measured under 25°C and frame frequency under 60Hz

Symble	Parameter	Min	Typ	Max	Units	Note
VDD	Logic/LCD Drive Voltage	3.0	3.3	3.6	[Volt]	
PDD	VDD Power	-	-	0.8	[Watt]	Note 1
IDD	IDD Current	-	-	0.22	[A]	Note 1
IRush	Inrush Current	-	-	2000	[mA]	Note 2
VDDrp	Allowable Logic/LCD Drive Ripple Voltage	-	-	100	[mV] p-p	

**Note 1** : Maximum Measurement Condition : Black Pattern at 3.3V driving voltage. ( $P_{max}=V_{3.3} \times I_{black}$ )

Typical Measurement Condition: Mosaic Pattern

**Note 2** : Measure Condition

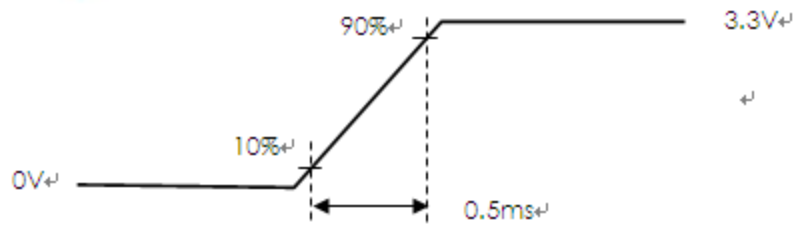
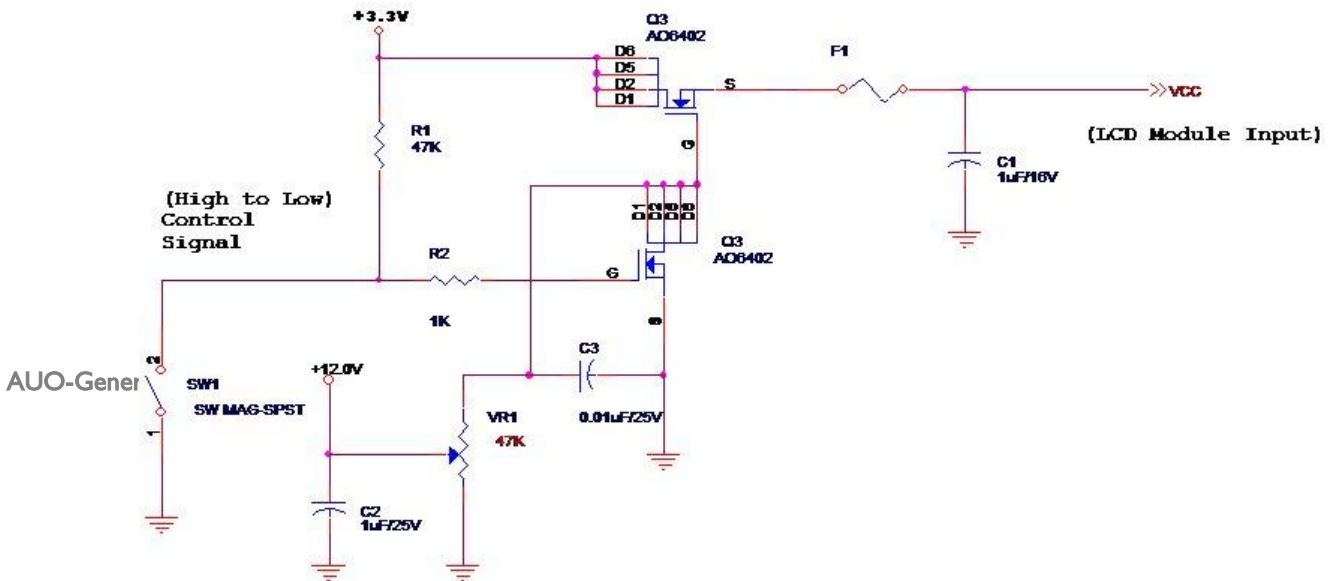

$V_{in}$  rising time

### 5.1.2 Signal Electrical Characteristics

Signal electrical characteristics are as follows;

#### Display Port main link signal:

Differential pair VD+ , VD-  
Which is one Display port  
Main link

VCM of Display port  
Main link

$$V_{diffP-P} = [(VD+) - (VD-)] \times 2$$

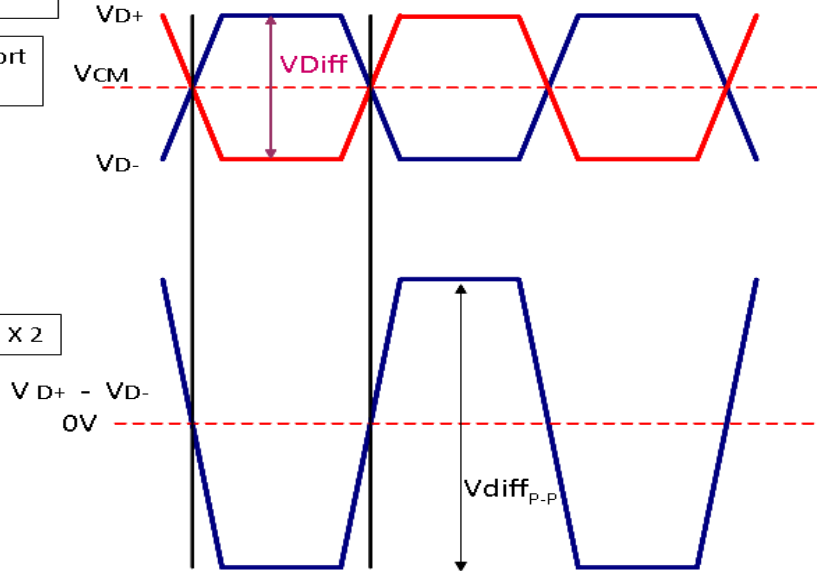

Display port main link					
		Min	Typ	Max	unit
VCM	RX input DC Common Mode Voltage		0		V
VDiff <sub>P-P</sub>	Peak-to-peak Voltage at a receiving Device	150		1320	mV

Follow as VESA display port standard V1.3

AUO-General

#### Display Port AUX\_CH signal:

Differential AUX+ , AUX-  
Which is Display port AUX\_CH

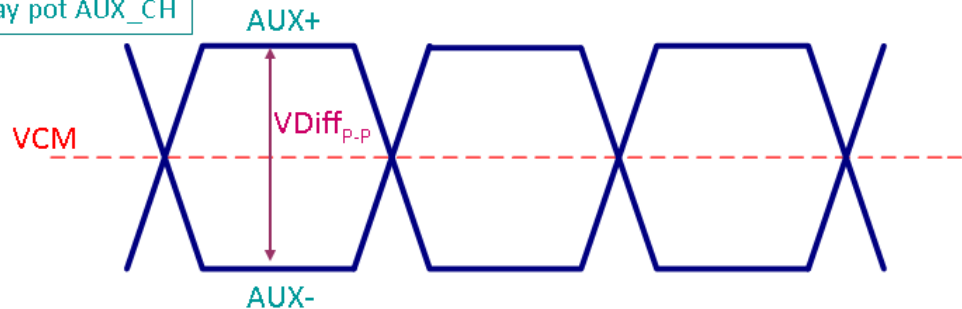

Display port AUX_CH					
		Min	Typ	Max	unit
VCM	AUX DC Common Mode Voltage		0		V
VDiff <sub>P-P</sub>	AUX Peak-to-peak Voltage at a receiving Device	0.4	0.6	0.8	V

Follow as VESA display port standard V1.3

**Display Port VHPD signal:**

Display port VHPD					
		Min	Typ	Max	unit
VHPD	HPD Voltage	2.25	-	3.6	V

Follow as VESA display port standard V1.1a

## 5.2 Backlight Unit

### 5.2.1 Parameter guideline for LED

Following characteristics are measured under stable condition using a LED driving board at 25°C (Room Temperature).

#### LED characteristics

Symbol	Parameter	Min	Typ	Max	Units	Condition
PLED	Backlight Power Consumption	--	---	4.15	[Watt]	
LTLED	LED Life-Time	30000	--	--	Hour	

**Note 1:** Calculator value for reference  $P_{LED} = VF$  (Normal Distribution) \*  $IF$  (Normal Distribution) / Efficiency

**Note 2:** The LED life-time define as the estimated time to 50% degradation of initial luminous.

#### Backlight input signal characteristics

Parameter	Symbol	Min	Typ	Max	Units	Remark
LED Power Supply	VLED	6.0	12.0	21.0	[Volt]	Define as Connector Interface (Ta=25°C)
LED Enable Input High Level	VLED_EN *Note 1	2.5	-	5.5	[Volt]	
LED Enable Input Low Level		-	-	0.5	[Volt]	
PWM Logic Input High Level	VPWM_EN *Note 1	2.5	-	5.5	[Volt]	
PWM Logic Input Low Level		-	-	0.5	[Volt]	
PWM Input Frequency	FPWM	200	1K	10K	Hz	
PWM Duty Ratio	Duty	5	--	100	%	

**Note1:** Recommend system pull up/down resistor no bigger than 10kohm

## 5.3 Touch Sensor Module

### 5.3.1 Power Specification

Items	Symbol	Specifications			Unit	Notes	
		Min.	Typ.	Max.			
Touch sensor module Power Supply	VTSP	4.5	5	5.5	V		
Touch sensor module Power Consumption	PTP	Active	-	-	550	mW	
		Idle	-	-	-	mW	
		Sleep	-	-	-	mW	
Touch Sensor Module Power ripple	VTSPrp	-	-	100	mV		

## 6. Signal Characteristic

### 6.1 Pixel Format Image

Following figure shows the relationship between input signal and LCD pixel format.

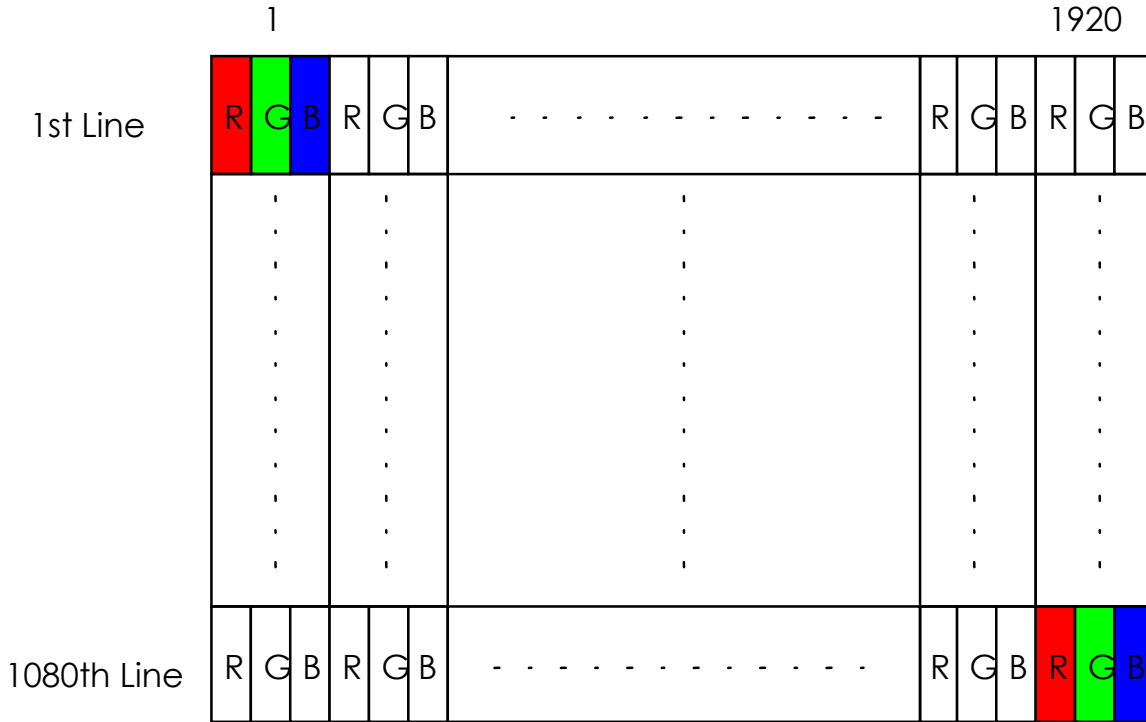

### 6.2 Scanning Direction

The following figures show the image seen from the front view. The arrow indicates the direction of scan.





### 6.3 Signal Description

The module uses a LVDS receiver embedded in AUO’s ASIC. eDP is a differential signal technology for LCD interface and a high-speed data transfer device.

#### 6.3.1 Connector Description

Physical interface is described as for the connector on module.

These connectors are capable of accommodating the following signals and will be following components.

Connector Name / Designation	For Signal Connector
Manufacturer	IPEX or compatible
Type / Part Number	IPEX 20765-040E-11A or compatible
Mating Housing/Part Number	IPEX 20453-040T-11 or Compatible

#### 6.3.2 Pin Assignment (with Touch Sensor Pin Assignment)

PIN NO	Symbol	Function
1	NC	Reserved for I2C _ RST
2	NC	Reserved for I2C _ INT
3	NC	Reserved for I2C _Data
4	NC	Reserved for I2C _CLK
5	NC	Reserved for TP_EN (Active High)
6	VTSP	Touch panel power supply
7	VTSP	Touch panel power supply
8	GND	Ground–Shield
9	TP_D+	USB Data+ for Touch
10	TP_D-	USB Data- for Touch
11	NC	No Connect (Reserved for CM)
12	BL_PWR	Backlight power
13	BL_PWR	Backlight power
14	BL_PWR	Backlight power
15	BL_PWR	Backlight power
16	NC	No connect (Reverse for AUO TEST only)
17	NC	No connect (Reverse for AUO TEST only)
18	BL PWM DIM	System PWM signal Input
19	BL_Enable	Backlight On / Off
20	BL_GND	Backlight_ground

21	BL_GND	Backlight_ground
22	BL_GND	Backlight_ground
23	BL_GND	Backlight_ground
24	HPD	HPD signal pin
25	LCD_GND	LCD logic and driver ground
26	LCD_GND	LCD logic and driver ground
27	LCD_Self_Test	LCD Panel Self Test Enable
28	LCD_VCC	LCD logic and driver power
29	LCD_VCC	LCD logic and driver power
30	H_GND	High Speed Ground
31	AUX_CH_N	Comp Signal Auxiliary Ch.
32	AUX_CH_P	True Signal Auxiliary Ch.
33	H_GND	High Speed Ground
34	Lane0_P	True Signal Link Lane 0
35	Lane0_N	Comp Signal Link Lane 0
36	H_GND	High Speed Ground
37	Lane1_P	True Signal Link Lane 1
38	Lane1_N	Comp Signal Link Lane 1
39	H_GND	High Speed Ground
40	NC	No Connect

AUO-Ge

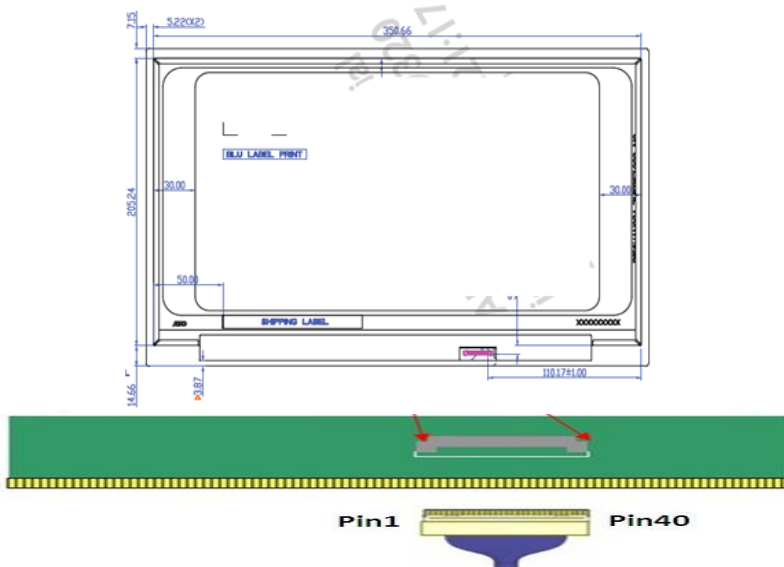

- Note1:** Start from right side.
- Note2:** Input signals shall be low or High-impedance state when VDD is off.
- Note3:** Internal circuit of **eDP inputs** are as following.

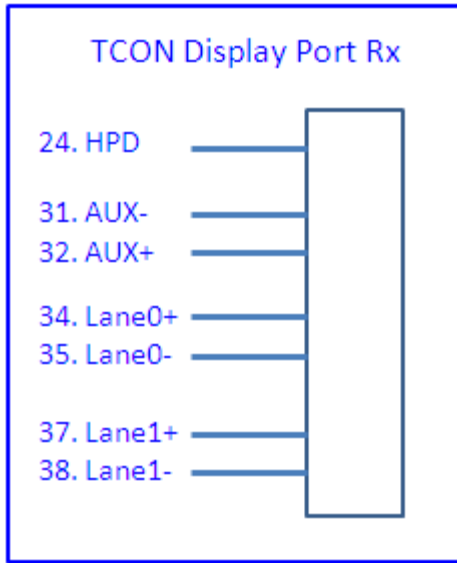

## 6.4 Interface Timing

### 6.4.1 Timing Characteristics

Basically, interface timings should match the 1920x1080 /60Hz manufacturing guide line timing.

Parameter		Symbol	Min.	Typ.	Max.	Unit
Frame Rate		-	-	60	-	Hz
Clock frequency		1/ T <sub>clock</sub>		141		MHz
Vertical Section	Period	T <sub>V</sub>	1124	1128	1080+A	T <sub>Line</sub>
	Active	T <sub>VD</sub>	1080			
	Blanking	T <sub>VB</sub>	44	48	A	
Horizontal Section	Period	T <sub>H</sub>	2076	2082	1920+B	T <sub>clock</sub>
	Active	T <sub>HD</sub>	1920			
	Blanking	T <sub>HB</sub>	156	162	B	

**Note1:** DE mode only

**Note2:** The maximum clock frequency = (1920+B)\*(1080+A)\*60 < 150MHz

**Note3:** Typical value refer to VESA STANDARD

### 6.4.2 Input Timing Diagram

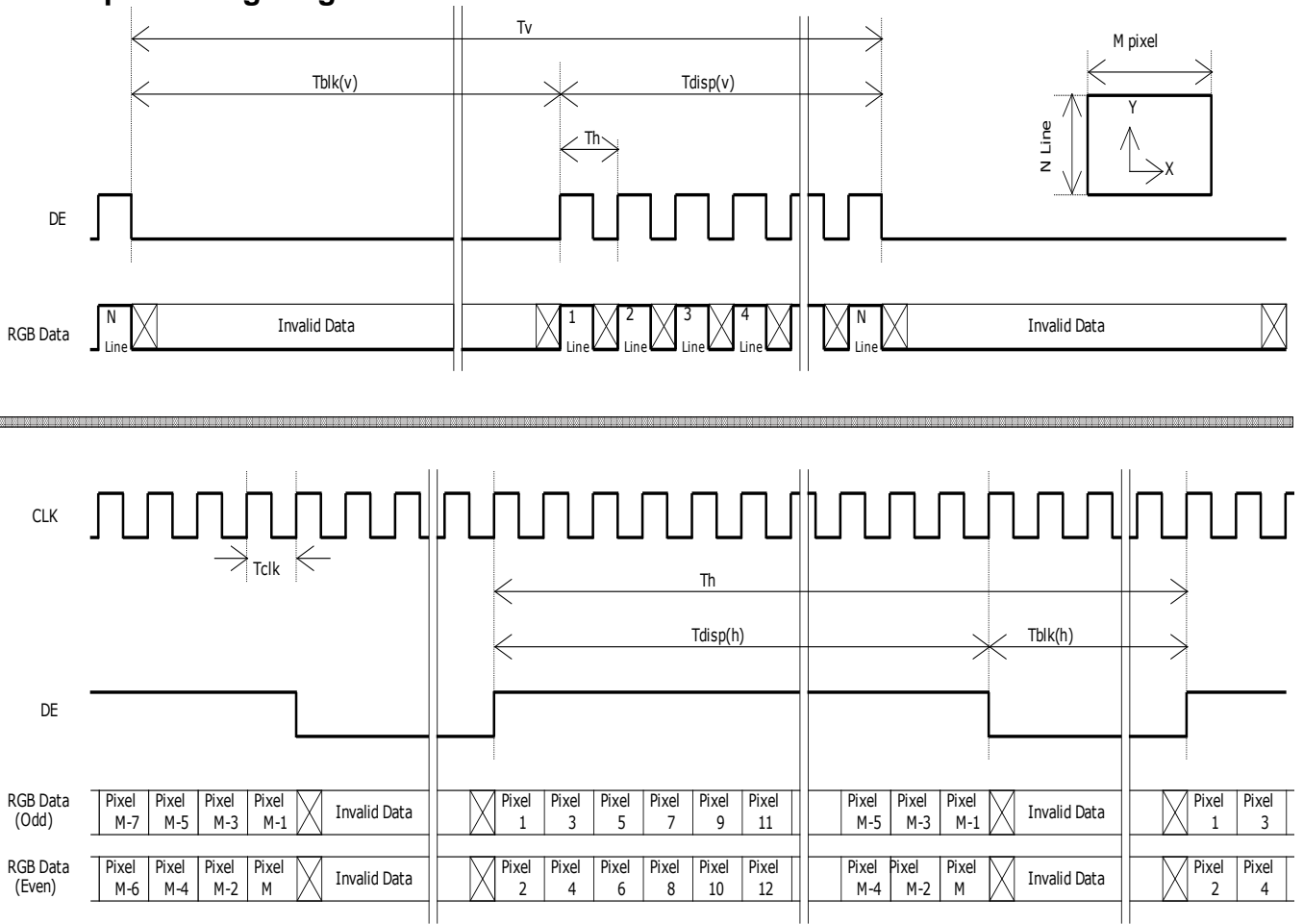

## 6.5 Power ON/OFF Sequence

Display Port panel power sequence:

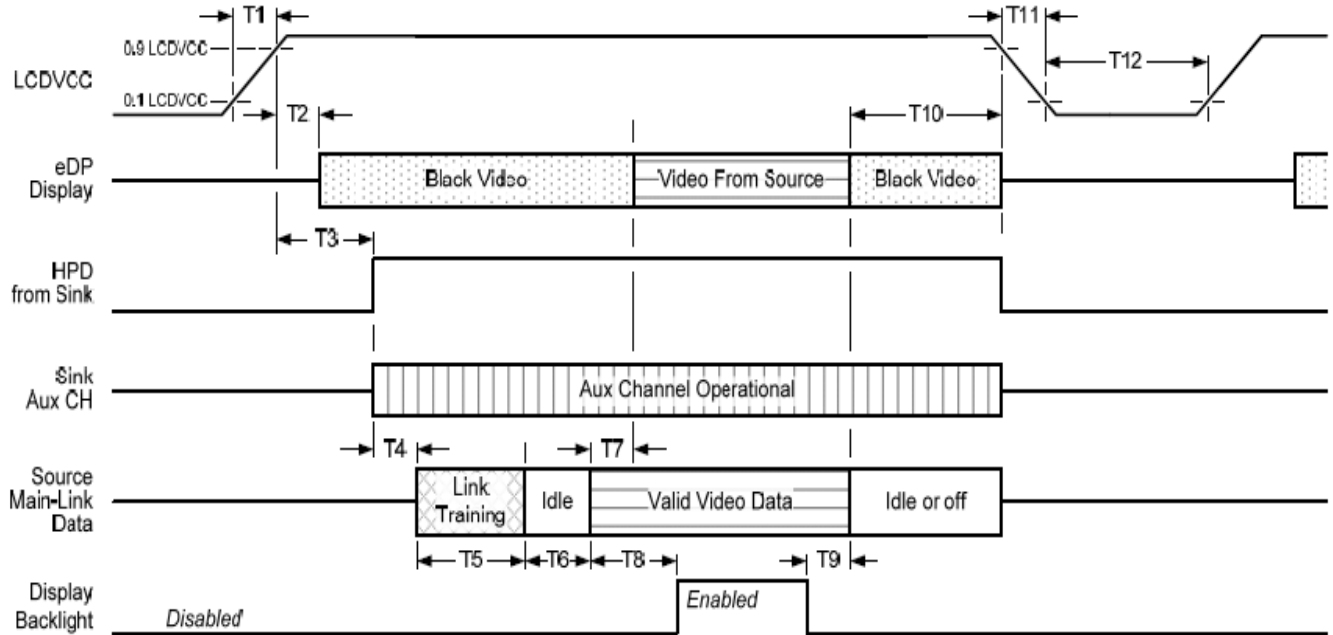

### Display port interface power up/down sequence, normal system operation

Display Port AUX\_CH transaction only:

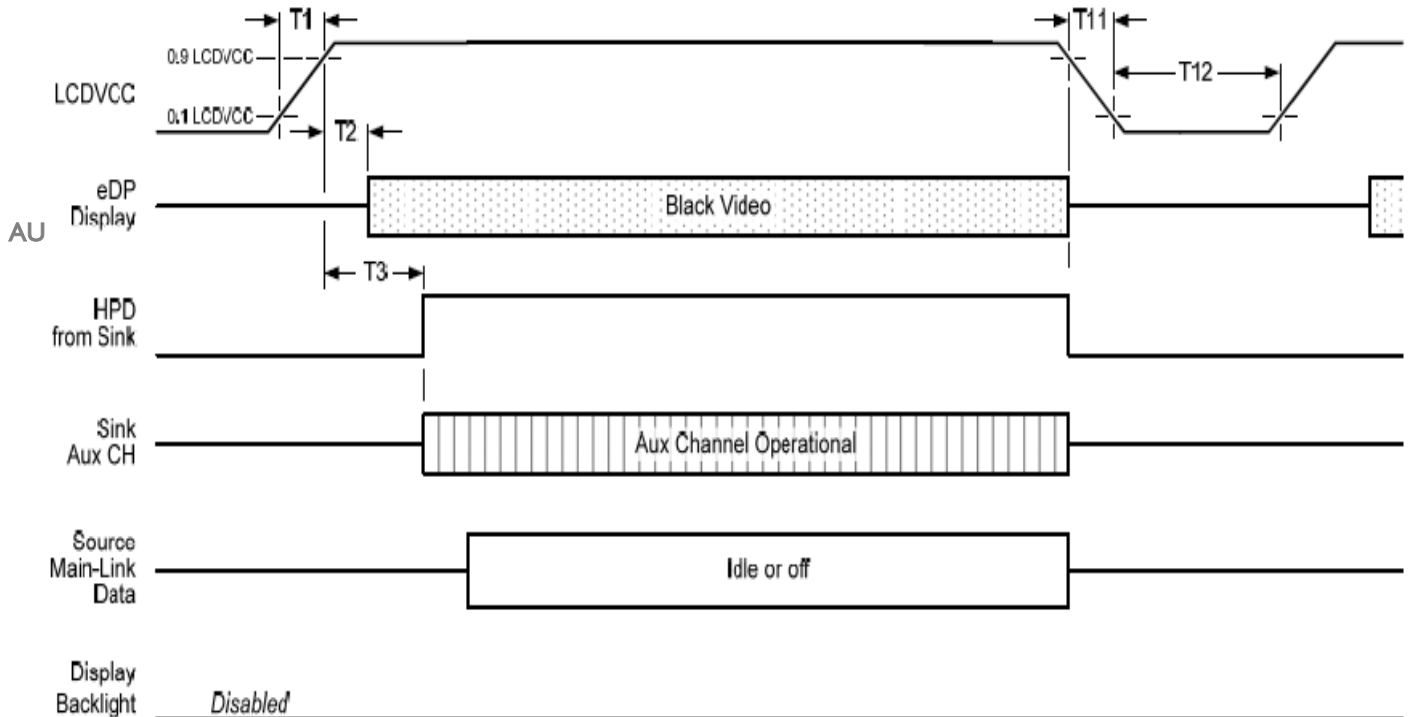

### Display port interface power up/down sequence, AUX\_CH transaction only

**Display Port panel power sequence timing parameter:**

Timing parameter	Description	Reqd. by	Limits			Notes
			Min.	Typ.	Max.	
T1	power rail rise time, 10% to 90%	source	0.5ms		10ms	
T2	delay from LCDVDD to black video generation	sink	0ms		200ms	prevents display noise until valid video data is received from the source
T3	delay from LCDVDD to HPD high	sink	0ms		200ms	sink AUX_CH must be operational upon HPD high.
T4	delay from HPD high to link training initialization	source				allows for source to read link capability and initialize.
T5	link training duration	source				dependant on source link to read training protocol.
T6	link idle	source				Min accounts for required BS-Idle pattern. Max allows for source frame synchronization.
T7	delay from valid video data from source to video on display	sink	0ms		50ms	max allows sink validate video data and timing.
T8	delay from valid video data from source to backlight enable	source				source must assure display video is stable.
T9	delay from backlight disable to end of valid video data	source				source must assure backlight is no longer illuminated.
T10	delay from end of valid video data from source to power off	source	0ms		500ms	
T11	power rail fall time, 90% to 10%	source			10ms	
T12	power off time	source	500ms			

**Note1:** The sink must include the ability to generate black video autonomously. The sink must automatically enable black video under the following conditions:

- upon LCDVDD power on (with in T2 max)-when the "Novideostream\_Flag" (VB-ID Bit 3) is received from the source (at the end of T9).

- when no main link data, or invalid video data, is received from the source. Black video must be displayed within 64ms (typ) from the start of either condition. Video data can be deemed invalid based on MSA and timing information, for example.

**Note 2:** The sink may implement the ability to disable the black video function, as described in Note 1, above, for system development and debugging purpose.

**Note 3:** The sink must support AUX\_CH polling by the source immediately following LCDVDD power on without causing damage to the sink device (the source can re-try if the sink is not ready). The sink must be able to respond to an AUX\_CH transaction with the time specified within T3 max.

**Display Port panel B/L power sequence timing parameter:**

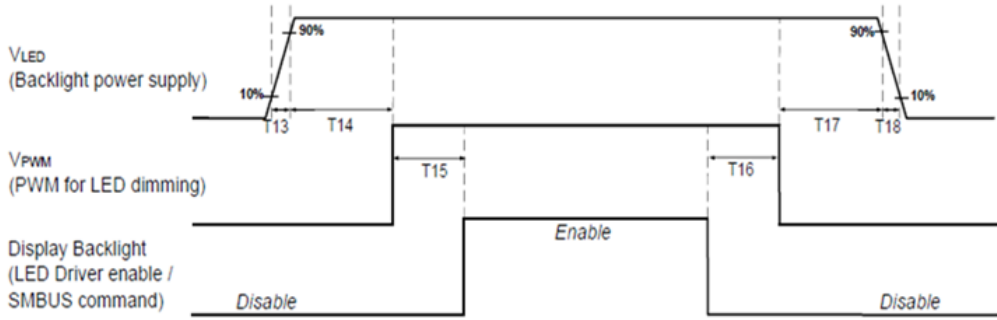

	Min (ms)	Max (ms)
T13	0.5	10
T14	10	-
T15	10	-
T16	10	-
T17	10	-
T18	0.5	10
T19	1*	-
T20	1*	-

Note : When the adapter is hot plugged, the backlight power supply sequence is shown as below.

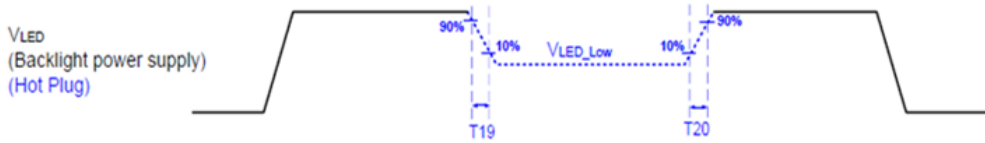

Seamless change:  $T19/T20 = 5 \times T_{PWM}^*$

\* $T_{PWM} = 1/PWM \text{ Frequency}$

**Touch Power on Sequence:**

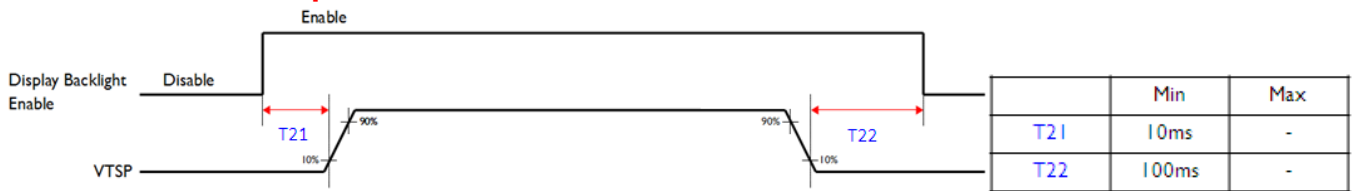

	Min	Max
T21	10ms	-
T22	100ms	-

## 7. Reliability Test Criteria

### 7.1 Vibration Test

Test Spec:

- Test method: Non-Operation
- Acceleration: 1.5 G
- Frequency: 10 - 200Hz Random
- Sweep: 30 Minutes each Axis (X, Y, Z)

### 7.2 Shock Test

Test Spec:

- Test method: Non-Operation
- Acceleration: 220 G , Half sine wave
- Active time: 2ms
- Pulse: X,Y,Z .one time for each side

### 7.3 Reliability Test

Items	Required Condition	Note
Temperature Humidity Bias	Ta= 40°C , 90%RH, 300h	
High Temperature Operation	Ta= 50°C , Dry, 300h	
Low Temperature Operation	Ta= 0°C , 300h	
High Temperature Storage	Ta= 60°C , 35%RH, 300h	
Low Temperature Storage	Ta= -20°C , 50%RH, 250h	
Thermal Shock Test	-20°C/30 min ,60°C/30 min ,100cycles	
ESD	Contact : ± 8KV/ operation, Class B Air : ± 15KV / operation, Class B	Note 1

Note1: According to EN61000-4-2, ESD class B: Some performance degradation allowed. No data lost  
 . Self-recoverable. No hardware failures.

Note 2:

- Water condensation is not allowed for each test items.
- Each test is done by new TFT-LCD module. Don't use the same TFT-LCD module repeatedly for reliability test.
- The reliability test is performed only to examine the TFT-LCD module capability.
- To inspect TFT-LCD module after reliability test, please store it at room temperature and room humidity for 24 hours at least in advance.
- No function failure occurs.



## 8. Mechanical Characteristics

### 8.1 LCM Outline Dimension (Front View and back view)

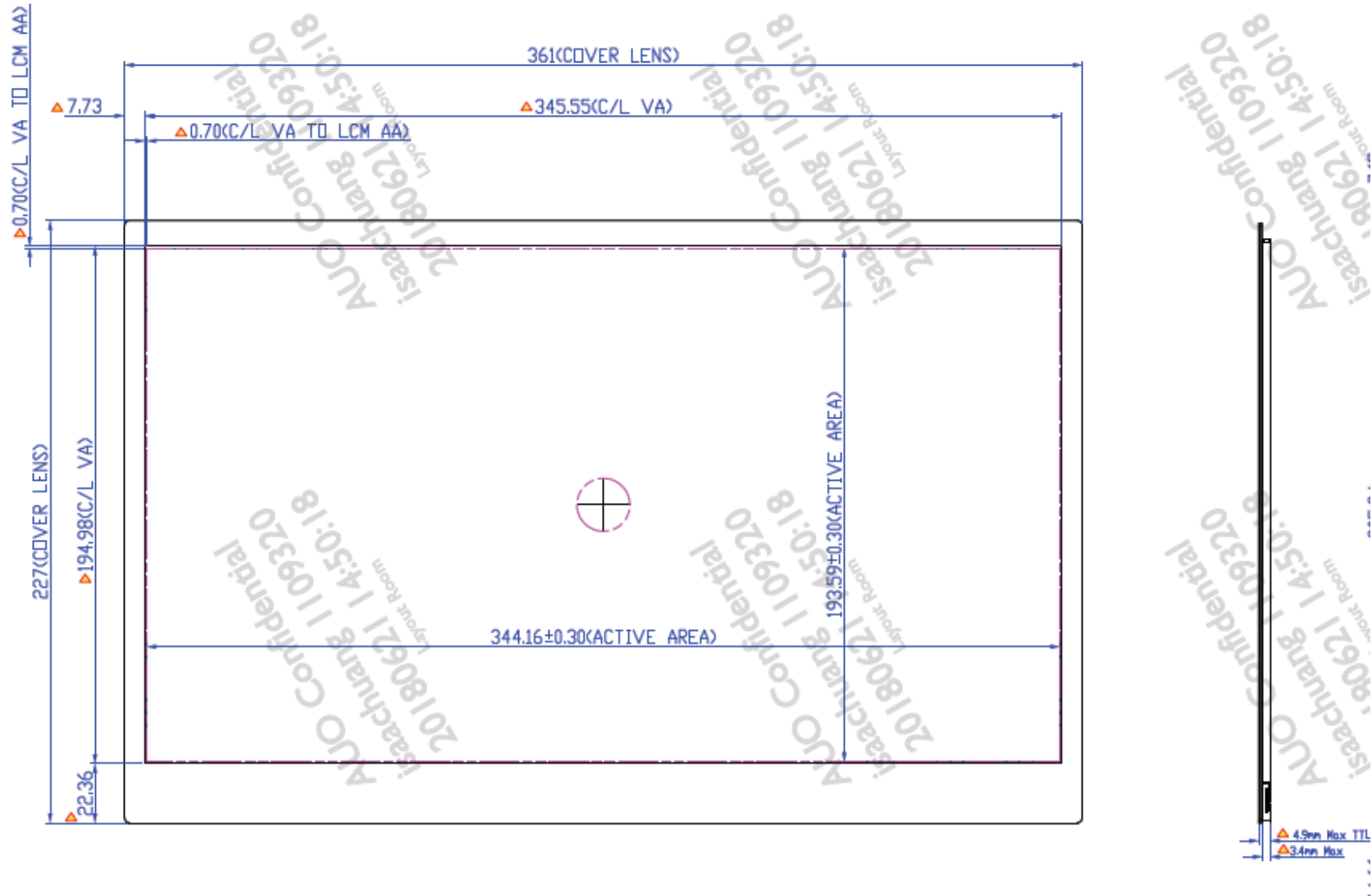

AUO-General

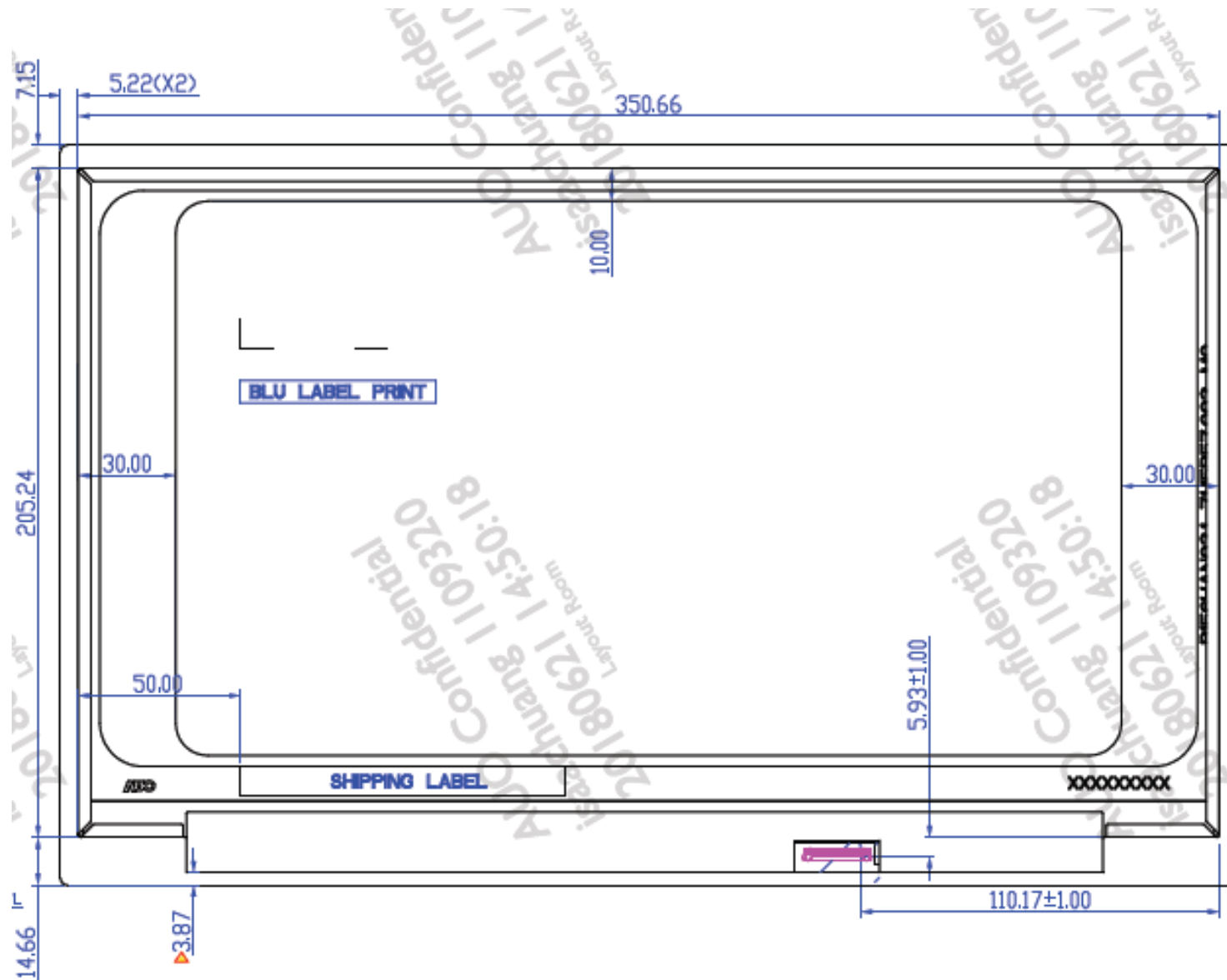

AUO-General

## 9. Label and Packaging

### 9.1 Shipping Label (on the rear side of TFT-LCD display)



### 9.2 Carton Package



1 - Put out PP Board

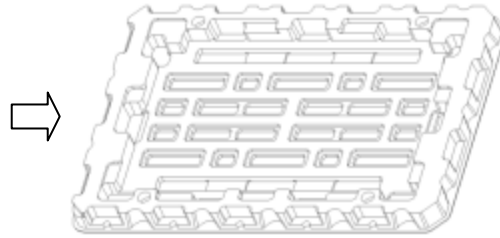

2 - Tray placed on PP Board

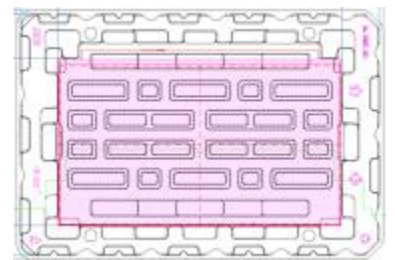

3 - Put 1Pcs EPE Spacer into Tray

4 - Put 1pcs panel on First Spacer

, **CF upwards in Tray**



5 - Finally,

**1 Pcs Tray contained 1pcs Panel + 1pcs Spacer**

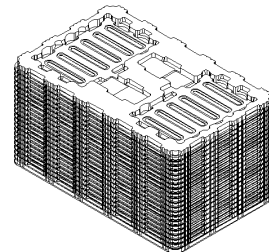
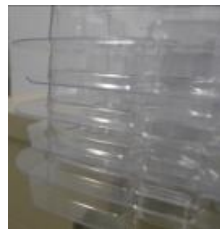

6 - Stack 17 layers PET tray as the method mention above (16tray+1dummy tray)



7 - Insert the package from the sideway of the Antistatic Bag. Pack the bag, and then tape



8 - Placing EPE into carton



9 - Placing trays into carton



10 - Cover with EPE cushion



11 - Sealing the carton with packing tape

### Palletizing sequence

The operation of taking shape and related information of full carton:

Max capacity : 16 TFT-LCD module per carton

Max weight: 14kg per carton

Outside dimension of carton: 508mm(H)\*408mm(W)\*279mm(H)

Pallet size : 1150 mm \* 840 mm \* 132mm

### Box stacked

Module by air : (2 \*2) \*5 layers , one pallet put 20 boxes , total 320pcs module

Module by sea : One pallet (2 \*2) \*5 layers + One pallet (2 \*2) \*1ayers , total 384pcs module

Module by sea\_ HQ : One pallet (2 \*2) \*5 layers + One pallet (2 \*2) \*2 layers , total 448pcs module

### 9.3 Shipping Package of Palletizing Sequence

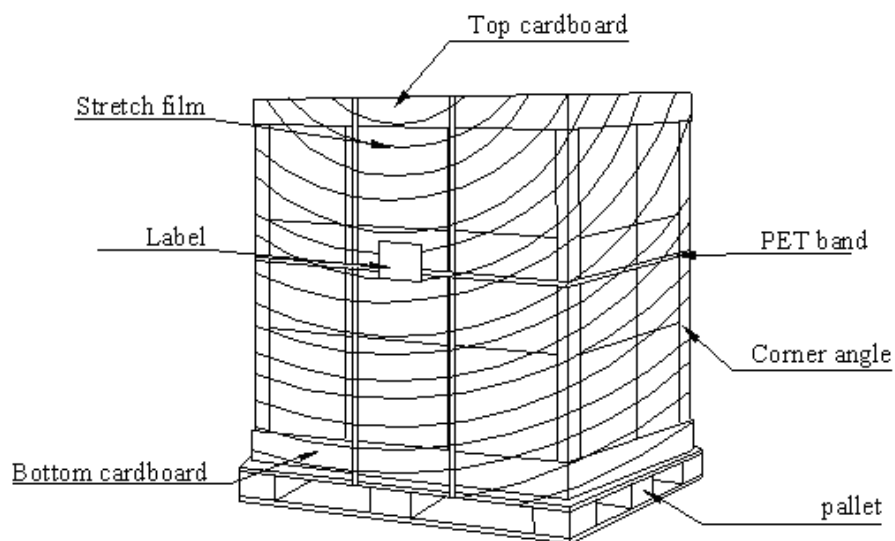

AUO-General

## 10. Safety

### 10.1 Sharp Edge Requirements

There will be no sharp edges or comers on the display assembly that could cause injury.

### 10.2 Materials

#### 10.2.1 Toxicity

There will be no carcinogenic materials used anywhere in the display module. If toxic materials are used, they will be reviewed and approved by the responsible AUO toxicologist.

#### 10.2.2 Flammability

All components including electrical components that do not meet the flammability grade UL94-V1 in the module will complete the flammability rating exception approval process.

The printed circuit board will be made from material rated 94-V1 or better. The actual UL flammability rating will be printed on the printed circuit board.

### 10.3 Capacitors

If any polarized capacitors are used in the display assembly, provisions will be made to keep them from being inserted backwards.

### 10.4 National Test Lab Requirement

The display module will satisfy all requirements for compliance to:

**UL 60950-1, Second Edition**

U.S.A. Information Technology Equipment