

NPN General Purpose Amplifier

BCP54

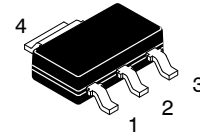

1: Base
2, 4: Collector
3: Emitter

SOT-223
CASE 318H

This device is designed for general purpose medium power amplifiers and switching circuits requiring collector currents to 1.2 A. Sourced from Process 38.

ABSOLUTE MAXIMUM RATINGS (T_A = 25 °C unless otherwise noted.)

Symbol	Parameter	Ratings	Unit
V _{CEO}	Collector-Emitter Voltage	45	V
V _{CBO}	Collector-Base Voltage	45	V
V _{EBO}	Emitter-Base Voltage	5.0	V
I _C	Collector Current – Continuous	1.5	A
T _J , T _{STG}	Operating and Storage Junction Temperature Range	-55 to +150	°C

Stresses exceeding those listed in the Maximum Ratings table may damage the device. If any of these limits are exceeded, device functionality should not be assumed, damage may occur and reliability may be affected.

- These ratings are based on a maximum junction temperature of 150 °C.
- These are steady state limits. The factory should be consulted on applications involving pulsed or low duty cycle operations.

THERMAL CHARACTERISTICS (T_A = 25°C unless otherwise noted.)

Symbol	Characteristic	Max	Unit
P _D	Total Device Dissipation Derate Above 25°C	1.5 12	W mW/°C
R _{θJA}	Thermal Resistance, Junction to Ambient	83.3	°C/W

ELECTRICAL CHARACTERISTICS (T_A = 25°C unless otherwise noted.)

Symbol	Parameter	Conditions	Min	Max	Unit
--------	-----------	------------	-----	-----	------

OFF CHARACTERISTICS

V _{(BR)CEO}	Collector-Emitter Breakdown Voltage	I _C = 10 mA, I _B = 0	45	-	V
V _{(BR)CBO}	Collector-Base Breakdown Voltage	I _C = 100 μA, I _E = 0	45	-	V
V _{(BR)EBO}	Emitter-Base Breakdown Voltage	I _E = 10 μA, I _C = 0	5.0	-	V
I _{CBO}	Collector-Cutoff Current	V _{CB} = 30 V, I _E = 0 V _{CB} = 30 V, I _E = 0, T _A = 125 °C	- -	100 10	nA μA
I _{EBO}	Emitter-Cutoff Current	V _{EB} = 5.0 V, I _C = 0	-	10	μA

ON CHARACTERISTICS

h _{FE}	DC Current Gain	I _C = 5.0 mA, V _{CE} = 2.0 V	25	-	
		I _C = 150 mA, V _{CE} = 2.0 V	40	250	
		I _C = 500 mA, V _{CE} = 2.0 V	25	-	
V _{CE(sat)}	Collector-Emitter Saturation Voltage	I _C = 500 mA, I _B = 50 mA	-	0.5	V
V _{BE(on)}	Base-Emitter On Voltage	I _C = 500 mA, V _{CE} = 2.0 V	-	1.0	V

Product parametric performance is indicated in the Electrical Characteristics for the listed test conditions, unless otherwise noted. Product performance may not be indicated by the Electrical Characteristics if operated under different conditions.

MARKING DIAGRAM

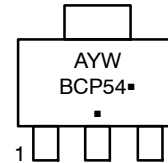

A = Assembly Location
Y = Year
W = Work Week
BCP54 = Specific Device Code
■ = Pb-Free Package

(Note: Microdot may be in either location)

ORDERING INFORMATION

Device	Package	Shipping
BCP54	SOT-223 (Pb-Free)	4,000 / Tape & Reel

†For information on tape and reel specifications, including part orientation and tape sizes, please refer to our Tape and Reel Packaging Specification Brochure, [BRD8011/D](#).

TYPICAL CHARACTERISTICS

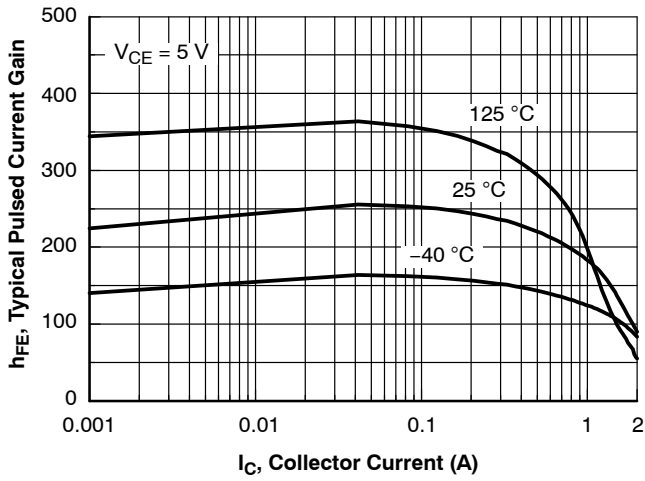

Figure 1. Typical Pulsed Current Gain vs Collector Current

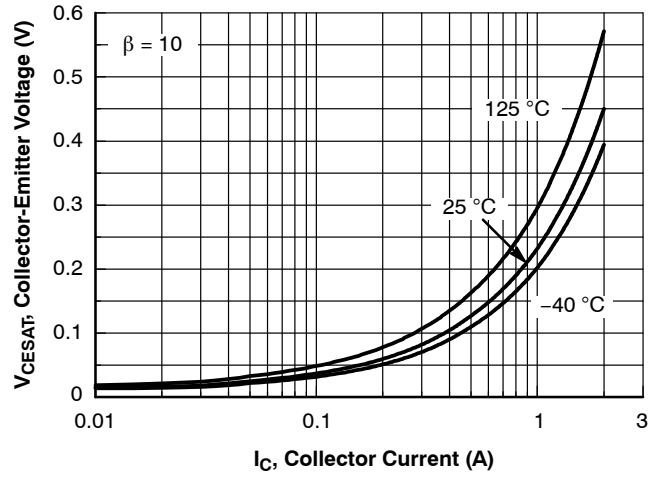

Figure 2. Collector-Emitter Saturation Voltage vs Collector Current

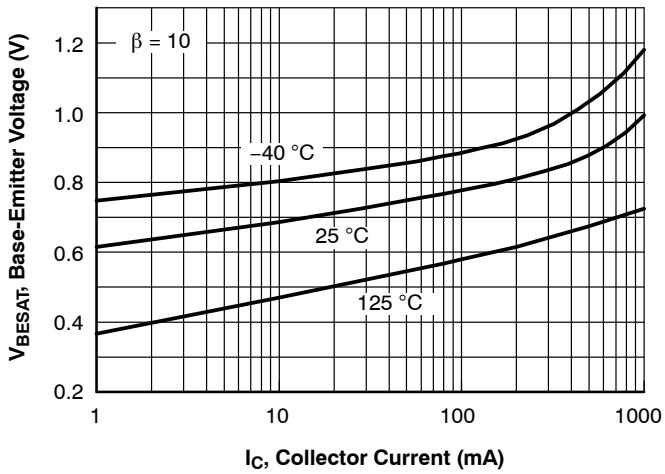

Figure 3. Base-Emitter Saturation Voltage vs Collector Current

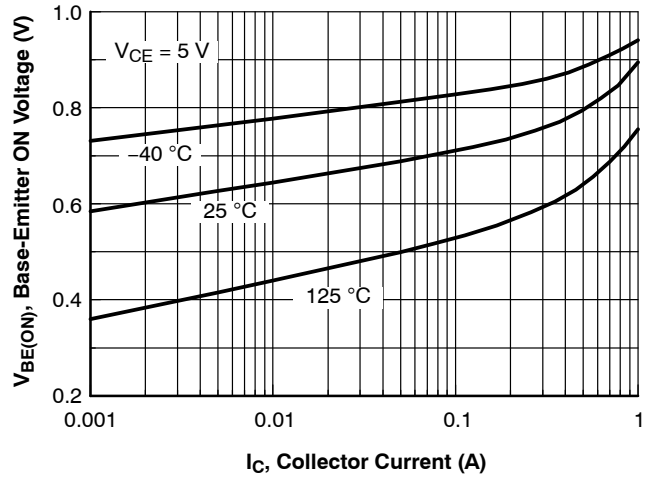

Figure 4. Base-Emitter ON Voltage vs Collector Current

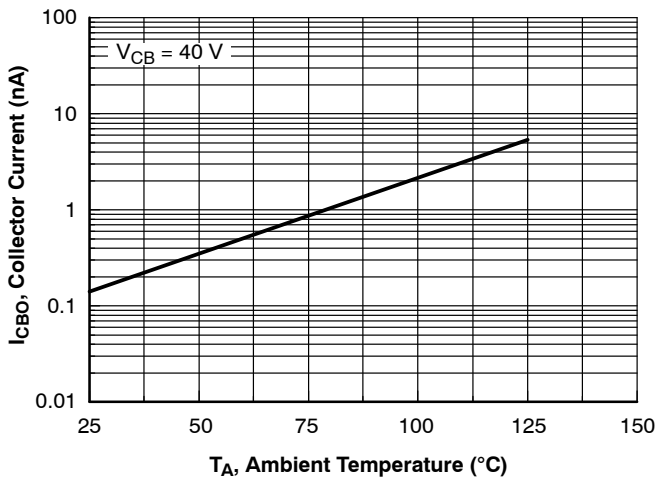

Figure 5. Collector-Cutoff Current vs Ambient Temperature

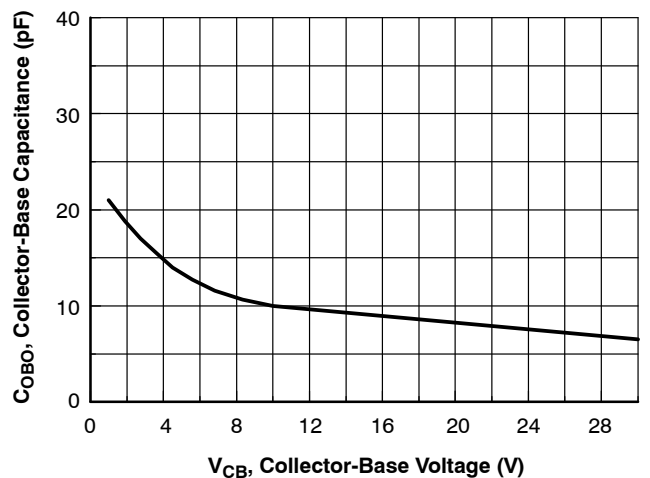

Figure 6. Collector-Base Capacitance vs Collector-Base Voltage

BCP54

TYPICAL CHARACTERISTICS (Continued)

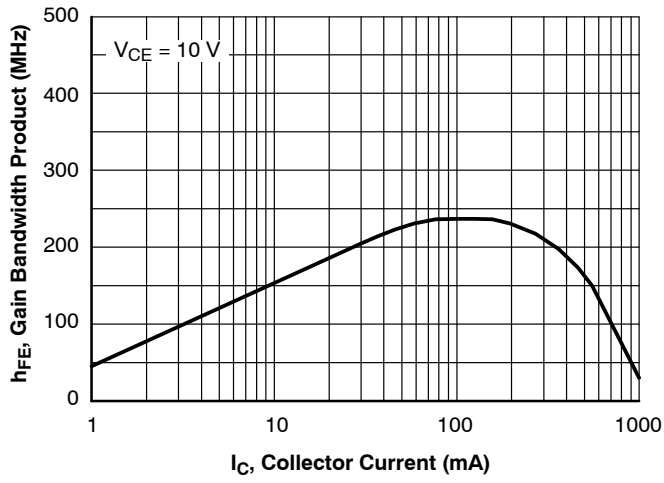

Figure 7. Gain Bandwidth Product vs Collector Current

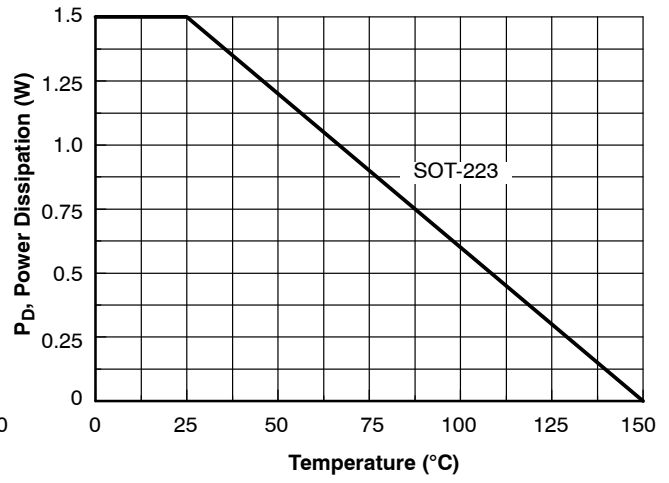
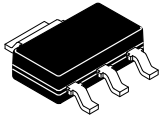

Figure 8. Power Dissipation vs Ambient Temperature



SCALE 2:1

SOT-223
CASE 318H
ISSUE B

DATE 13 MAY 2020

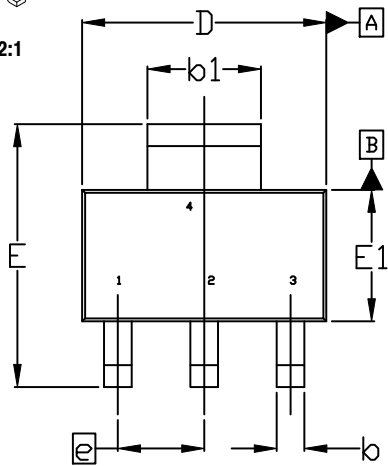

TOP VIEW

$\text{C} \text{ A} \text{ B}$

NOTE 7

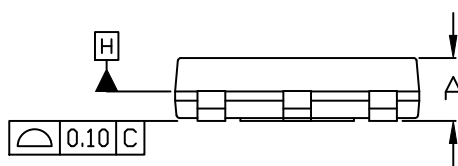

SIDE VIEW

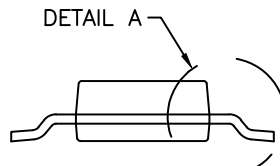

END VIEW

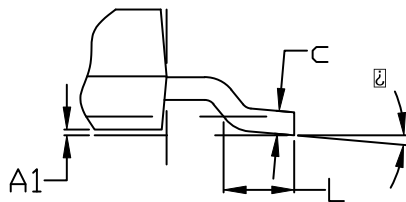

DETAIL A

NOTES:

1. DIMENSIONING AND TOLERANCING PER ASME Y14.5M, 2009.
2. CONTROLLING DIMENSION: MILLIMETERS
3. DIMENSIONS D & E1 ARE DETERMINED AT DATUM H. DIMENSIONS DO NOT INCLUDE MOLD FLASH, PROTRUSIONS OR GATE BURRS. SHALL NOT EXCEED 0.23mm PER SIDE.
4. LEAD DIMENSIONS b AND b1 DO NOT INCLUDE DAMBAR PROTRUSION. ALLOWABLE DAMBAR PROTRUSION IS 0.08mm PER SIDE.
5. DATUMS A AND B ARE DETERMINED AT DATUM H.
6. A1 IS DEFINED AS THE VERTICAL DISTANCE FROM THE SEATING PLANE TO THE LOWEST POINT OF THE PACKAGE BODY.
7. POSITIONAL TOLERANCE APPLIES TO DIMENSIONS b AND b1.

DIM	MILLIMETERS		
	MIN.	NOM.	MAX.
A	---	---	1.80
A1	0.02	0.06	0.11
b	0.60	0.74	0.88
b1	2.90	3.00	3.10
c	0.24	---	0.35
D	6.30	6.50	6.70
E	6.70	7.00	7.30
E1	3.30	3.50	3.70
e	2.30 BSC		
L	0.25	---	---
C	0°	---	10°

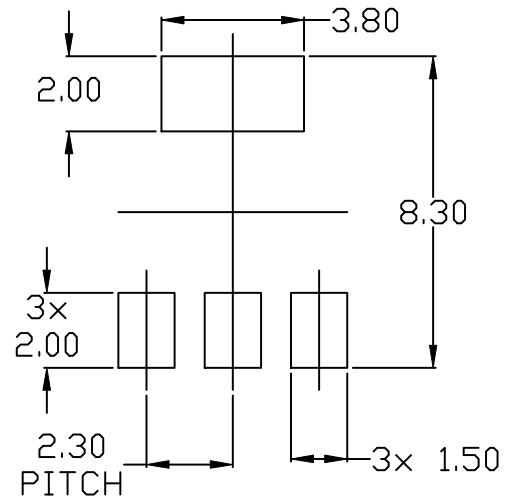

RECOMMENDED MOUNTING FOOTPRINT

* For additional information on our Pb-Free strategy and soldering details, please download the ON Semiconductor Soldering and Mounting Techniques Reference Manual, SOLDERM/D.

GENERIC MARKING DIAGRAM*

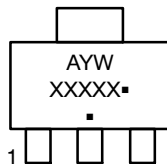

- A = Assembly Location
- Y = Year
- W = Work Week
- XXXXX = Specific Device Code
- = Pb-Free Package

(Note: Microdot may be in either location)

*This information is generic. Please refer to device data sheet for actual part marking. Pb-Free indicator, "G" or microdot "▪", may or may not be present. Some products may not follow the Generic Marking.

DOCUMENT NUMBER:	98ASH70634A	Electronic versions are uncontrolled except when accessed directly from the Document Repository. Printed versions are uncontrolled except when stamped "CONTROLLED COPY" in red.
DESCRIPTION:	SOT-223	PAGE 1 OF 1

onsemi and ONSEMI are trademarks of Semiconductor Components Industries, LLC dba onsemi or its subsidiaries in the United States and/or other countries. onsemi reserves the right to make changes without further notice to any products herein. onsemi makes no warranty, representation or guarantee regarding the suitability of its products for any particular purpose, nor does onsemi assume any liability arising out of the application or use of any product or circuit, and specifically disclaims any and all liability, including without limitation special, consequential or incidental damages. onsemi does not convey any license under its patent rights nor the rights of others.

onsemi, **Onsemi**, and other names, marks, and brands are registered and/or common law trademarks of Semiconductor Components Industries, LLC dba "**onsemi**" or its affiliates and/or subsidiaries in the United States and/or other countries. **onsemi** owns the rights to a number of patents, trademarks, copyrights, trade secrets, and other intellectual property. A listing of **onsemi**'s product/patent coverage may be accessed at www.onsemi.com/site/pdf/Patent-Marking.pdf. **onsemi** reserves the right to make changes at any time to any products or information herein, without notice. The information herein is provided "as-is" and **onsemi** makes no warranty, representation or guarantee regarding the accuracy of the information, product features, availability, functionality, or suitability of its products for any particular purpose, nor does **onsemi** assume any liability arising out of the application or use of any product or circuit, and specifically disclaims any and all liability, including without limitation special, consequential or incidental damages. Buyer is responsible for its products and applications using **onsemi** products, including compliance with all laws, regulations and safety requirements or standards, regardless of any support or applications information provided by **onsemi**. "Typical" parameters which may be provided in **onsemi** data sheets and/or specifications can and do vary in different applications and actual performance may vary over time. All operating parameters, including "Typicals" must be validated for each customer application by customer's technical experts. **onsemi** does not convey any license under any of its intellectual property rights nor the rights of others. **onsemi** products are not designed, intended, or authorized for use as a critical component in life support systems or any FDA Class 3 medical devices or medical devices with a same or similar classification in a foreign jurisdiction or any devices intended for implantation in the human body. Should Buyer purchase or use **onsemi** products for any such unintended or unauthorized application, Buyer shall indemnify and hold **onsemi** and its officers, employees, subsidiaries, affiliates, and distributors harmless against all claims, costs, damages, and expenses, and reasonable attorney fees arising out of, directly or indirectly, any claim of personal injury or death associated with such unintended or unauthorized use, even if such claim alleges that **onsemi** was negligent regarding the design or manufacture of the part. **onsemi** is an Equal Opportunity/Affirmative Action Employer. This literature is subject to all applicable copyright laws and is not for resale in any manner.

ADDITIONAL INFORMATION

TECHNICAL PUBLICATIONS:

Technical Library: www.onsemi.com/design/resources/technical-documentation
onsemi Website: www.onsemi.com

ONLINE SUPPORT: www.onsemi.com/support

For additional information, please contact your local Sales Representative at www.onsemi.com/support/sales