



## SPECIFICATIONS

<b>CUSTOMER</b>	:	<b>CDE030</b>
<b>SAMPLE CODE</b>	:	<b>SE12864LRF-042-H-Q</b>
<b>MASS PRODUCTION CODE</b>	:	<b>PE12864LRF-042-H-Q</b>
<b>SAMPLE VERSION</b>	:	<b>01</b>
<b>SPECIFICATIONS EDITION</b>	:	<b>003</b>
<b>DRAWING NO. (Ver.)</b>	:	<b>HLMD-PE12864LRF-042-H-Q_001</b>
<b>PACKAGING NO. (Ver.)</b>	:	<b>HPKG-PE12864LRF-042-H-Q_001</b>

**Customer Approved**

**Date:**

Approved	Checked	Designer
王剛/張慶源	詹漢華	黃杰峰/魏永超



- Preliminary specification for design input
- Specification for sample approval

### POWERTIP TECH. CORP.

<b>Headquarters:</b> No.8, 6 <sup>th</sup> Road, Taichung Industrial Park, Taichung, Taiwan 台中市 407 工業區六路 8 號	TEL: 886-4-2355-8168 FAX: 886-4-2355-8166	E-mail: <a href="mailto:sales@powertip.com.tw">sales@powertip.com.tw</a> Http://www.powertip.com.tw
---	--	--

### RECORDS OF REVISION

Date <small>(mm / dd / yyyy)</small>	Ver.	Edi.	Description	Page	Design by
10/07/2008	01	001	New Drawing		黃杰峰
11/11/2008	01	002	First Sample		黃杰峰
03/27/2009	01	003	MASS PRODUCTING		黃杰峰

Total : 26pages

## Contents

### 1. SPECIFICATIONS

- 1.1 Features
- 1.2 Mechanical Specifications
- 1.3 Absolute Maximum Ratings
- 1.4 DC Electrical Characteristics
- 1.5 Optical Characteristics
- 1.6 Backlight Characteristics

### 2. MODULE STRUCTURE

- 2.1 Counter Drawing
- 2.2 Interface Pin Description
- 2.3 Timing Characteristics
- 2.4 Display command
- 2.5 Jumper

### 3. QUALITY ASSURANCE SYSTEM

- 3.1 Quality Assurance Flow Chart
- 3.2 Inspection Specification

### 4. RELIABILITY TEST

- 4.1 Reliability Test Condition

### 5. PRECAUTION RELATING PRODUCT HANDLING

- 5.1 Safety
- 5.2 Handling
- 5.3 Storage
- 5.4 Terms of Warranty

- Appendix: 1. LCM Drawing  
2. Packing Specification

## 1. SPECIFICATIONS

### 1.1 Features

Item	Standard Value
Display Type	128*64 Dots
LCD Type	FSTN, Positive, Transflective, Extended Temperature
Driver Condition	LCD Module : 1/65 Duty , 1/9 Bias
Viewing Direction	6 O'clock
Backlight	Yellow-Green LED B/L
Weight	29.4 g
Interface	4-line serial interface
Other(controller / driver IC)	ST7567
ROHS	THIS PRODUCT CONFORMS THE ROHS OF PTC Detail information please refer web side : <a href="http://www.powertip.com.tw/news/LatestNews.asp">http://www.powertip.com.tw/news/LatestNews.asp</a>

### 1.2 Mechanical Specifications

Item	Standard Value	Unit
Outline Dimension	80.0(L) *54.0(w) (except FPC length) * 9.7(H)	mm
Viewing Area	70.7 (W) * 38.8 (L)	mm
Active Area	66.545(W) *33.265 (L)	mm
Dot Size	0.505 (W) * 0.505 (L)	mm
Dot Pitch	0.52(W) * 0.52 (L)	mm

Note : For detailed information please refer to LCM drawing

### 1.3 Absolute Maximum Ratings

Item	Symbol	Condition	Min.	Max.	Unit
Power Supply Voltage	VDD	—	-0.3	3.6	V
LCD Driver Supply Voltage	V0-XV0	—	-0.3	16	V
Operating Temperature	T <sub>OP</sub>	—	-20	70	°C
Storage Temperature	T <sub>ST</sub>	—	-30	+80	°C
Storage Humidity	H <sub>D</sub>	Ta < 60 °C	-	90	%RH

## 1.4 DC Electrical Characteristics

 $V_{SS} = 0V, Ta = 25^{\circ}C$ 

Item	Symbol	Condition	Min.	Typ.	Max.	Unit
Logic Supply Voltage	VDD	-	2.7	3.0	3.3	V
“H” Input Voltage	$V_{IH}$	-	0.7 VDD	-	VDD	V
“L” Input Voltage	$V_{IL}$	-	VSS	-	0.3VDD	V
“H” Output Voltage	$V_{OH}$	$I_{OUT}=1mA, VDD=3.0V$	0.8VDD	-	VDD	V
“L” Output Voltage	$V_{OL}$	$I_{OUT}=-1mA, VDD=3.0V$	VSS	-	0.2 VDD	V
Supply Current	$I_{dd}$	$V_{DD}=3.0V; V_{OP}=8.5V;$ Pattern= Full display	-	0.31	-	mA
		$V_{DD}=3.0V; V_{OP}=8.5V;$ Pattern= Horizontal line*1	-	0.75	1.5	
LCM Driver Voltage	$V_{OP*2}$	-20°C	8.5	8.7	8.9	V
		25°C	8.3	8.5	8.7	
		70°C	8.2	8.4	8.6	

NOTE: \*1 The Maximum current display;

\*2 The VOP test point is the capacitance of C10.

## 1.5 Optical Characteristics

LCD Panel : 1/65Duty , 1/9Bias ,  $V_{LCD} = 8.5V$  ,  $T_a = 25^{\circ}C$

Item	Symbol	Conditions	Min.	Typ.	Max.	Unit	Reference	
Response Time	Rise	tr	-	100	150	ms	Note2	
	Fall	tf	-	250	375			
Viewing angle range	Top	$\Theta Y+$	$C \geq 2.0$ , $\varnothing = 270^{\circ}$	-	-	40	Deg.	Notes 1
	Bottom	$\Theta Y-$		-	-	40		
	Left	$\Theta X-$		-	-	45		
	Right	$\Theta X+$		-	-	45		
Contrast Ratio	C	$\theta = 0^{\circ}$ , $\varnothing = 270^{\circ}$	2	4	-	-	Note 3	
Average Brightness (with LCD) *2	IV	IF=80mA	2.5	3.0	-	cd/m <sup>2</sup>	Note 4	
Wavelength	Hue		569	571	576	nm		
Uniformity *1	$\Delta B$		70	-	-	%		

Note 4 :

1 :  $\Delta B = B(\min) / B(\max) * 100\%$

2 : Measurement Condition for Optical Characteristics:

a : Environment:  $25^{\circ}C \pm 5^{\circ}C$  /  $60 \pm 20\% R.H$  , no wind , dark room below 10 Lux at typical lamp current and typical operating frequency.

b : Measurement Distance:  $500 \pm 50$  mm , ( $\theta = 0^{\circ}$ )

c : Equipment: TOPCON BM-7 fast , (field  $1^{\circ}$ ) , after 10 minutes operation.

d : The uncertainty of the C.I.E coordinate measurement  $\pm 0.01$  , Average Brightness  $\pm 4\%$

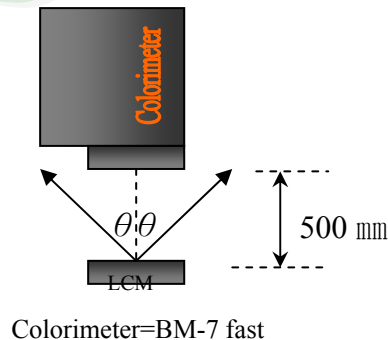
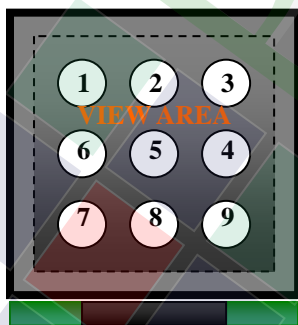

Note 1.

Optical characteristics-2

Viewing angle

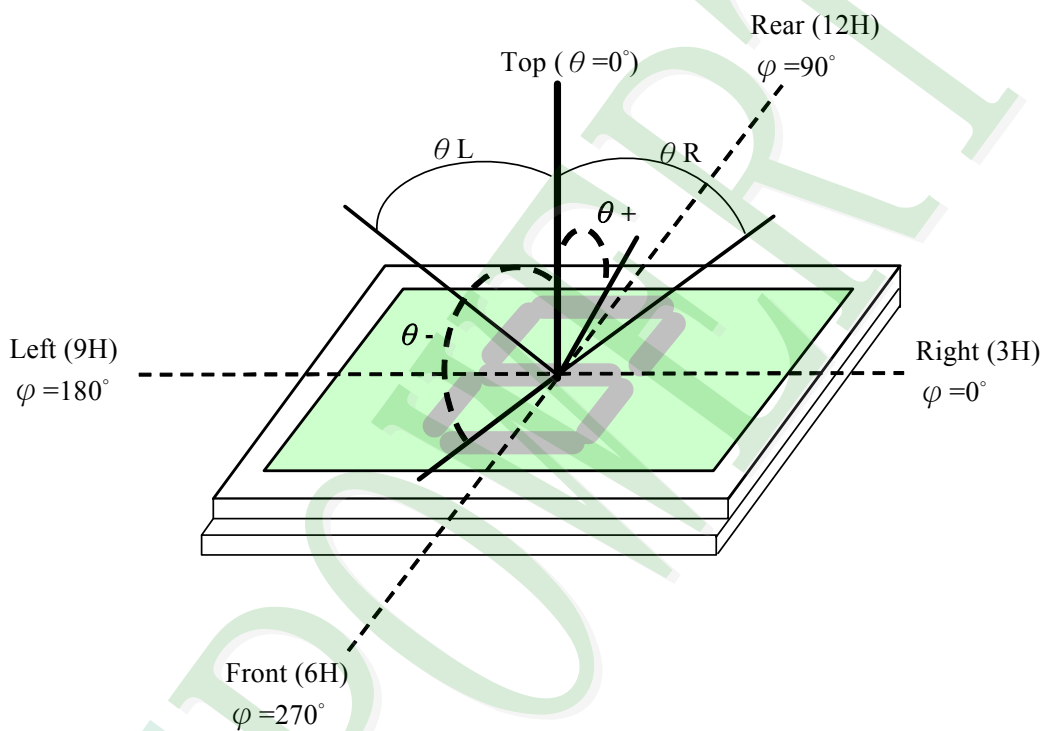

**Viewing angle**

Note 2.

Optical characteristics-3

Fig.2 Definition of response time

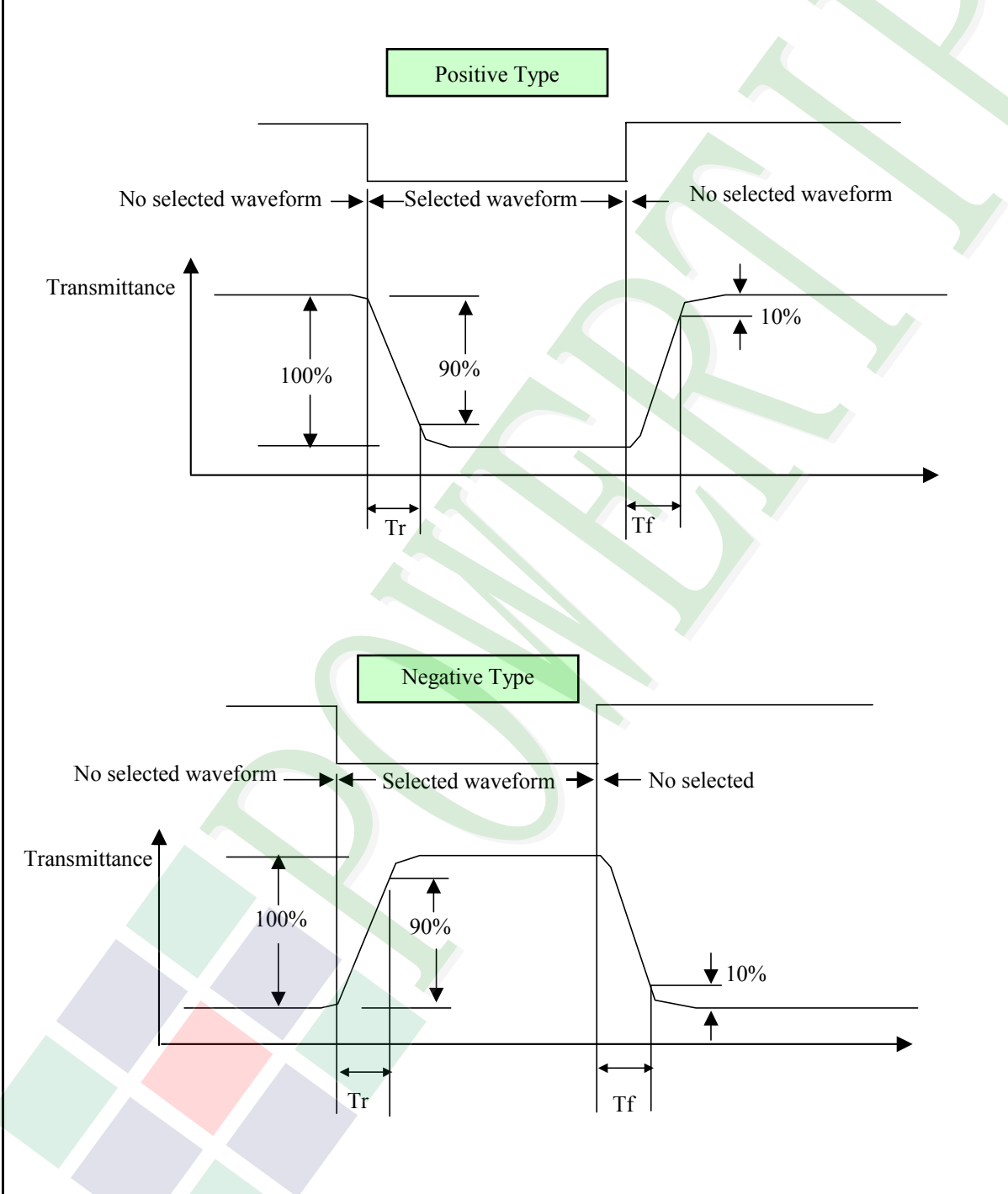



Electrical characteristics-2

※2 Drive waveform

$V_{op}$ : Drive voltage

$f_F$ : Frame frequency

$1/B$ : Bias

$f_D$ : Drive frequency

$N$ : Duty

(1) Selected waveform

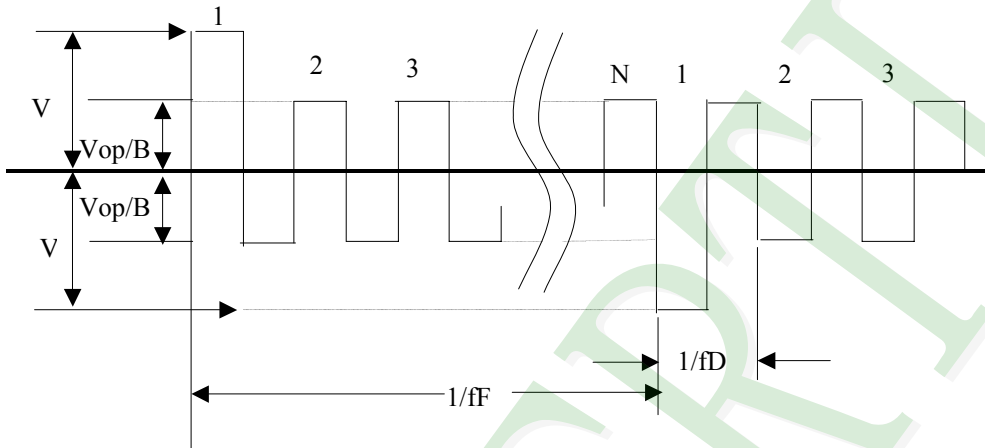

(2) Non- Selected wave form

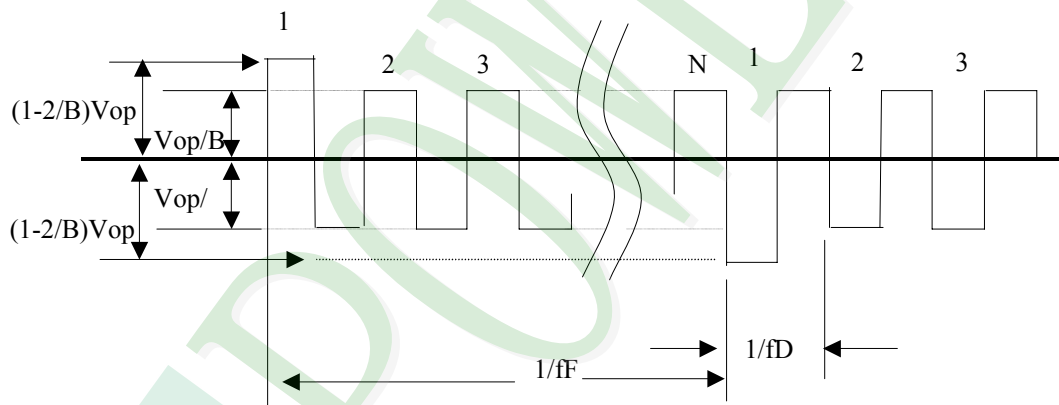

Note:

Frame frequency is defined as follows: Common side supply voltage peak - to - peak / 2 = 1 period

Note 3. : Definition of Vth

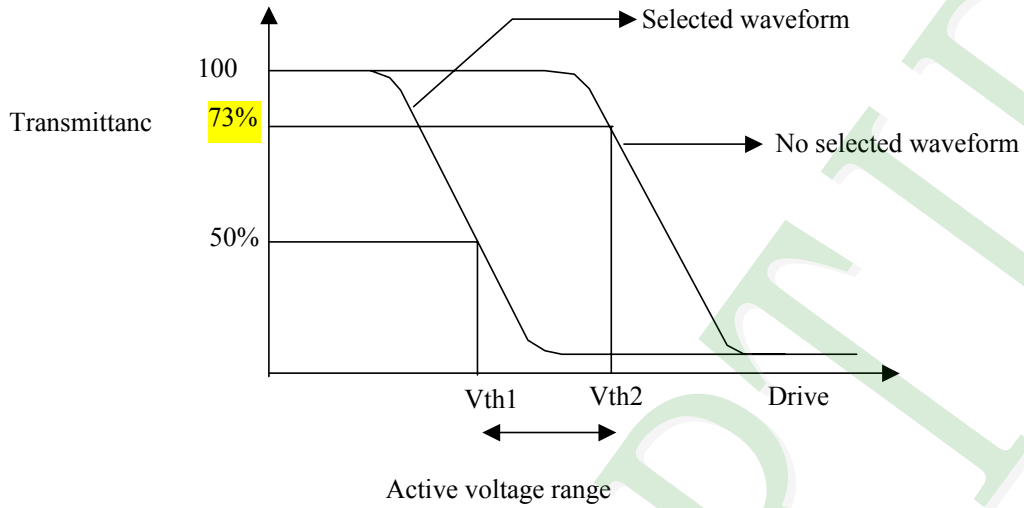

	Vth1	Vth2
View direction	10°	40°
Drive waveform	(Selected waveform)	(No selected waveform)
Transmittance	50%	73%

※1 Contrast ratio  
 = (Brightness in OFF state) / (Brightness in ON state)

Outline of Electro-Optical Characteristics Measuring System

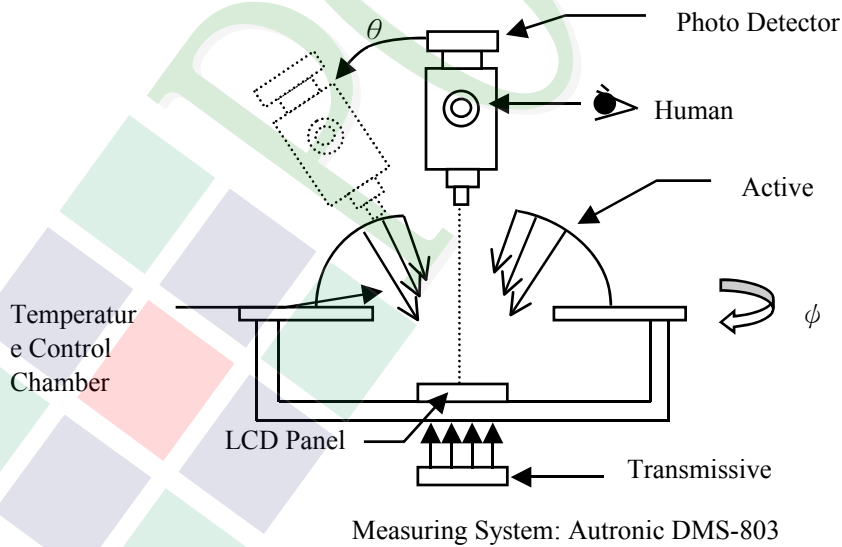

## 1.6 Backlight Characteristics

LCD Module with LED Backlight

### Maximum Ratings

Item	Symbol	Conditions	Ratings	Unit
Forward Current	IF	Ta =25°C	80	mA
Power Dissipation	PD	Ta =25°C	336	mW

### Electrical / Optical Characteristics

Item	Symbol	Conditions	Min.	Typ.	Max.	Unit
Forward Voltage	VF	IF=80mA	-	4.2	4.6	V
Average Brightness (without LCD)	IV	IF=80mA	9.6	12.0	-	cd/m <sup>2</sup>
Color	YELLOW-GREEN					

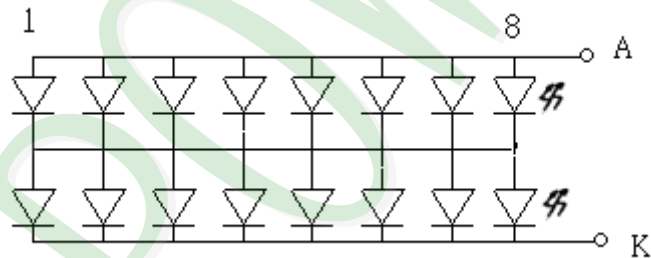

## 2. MODULE STRUCTURE

### 2.1 Counter Drawing

#### 2.1.1 LCM Mechanical Diagram

\* See Appendix

#### 2.1.2 Block Diagram

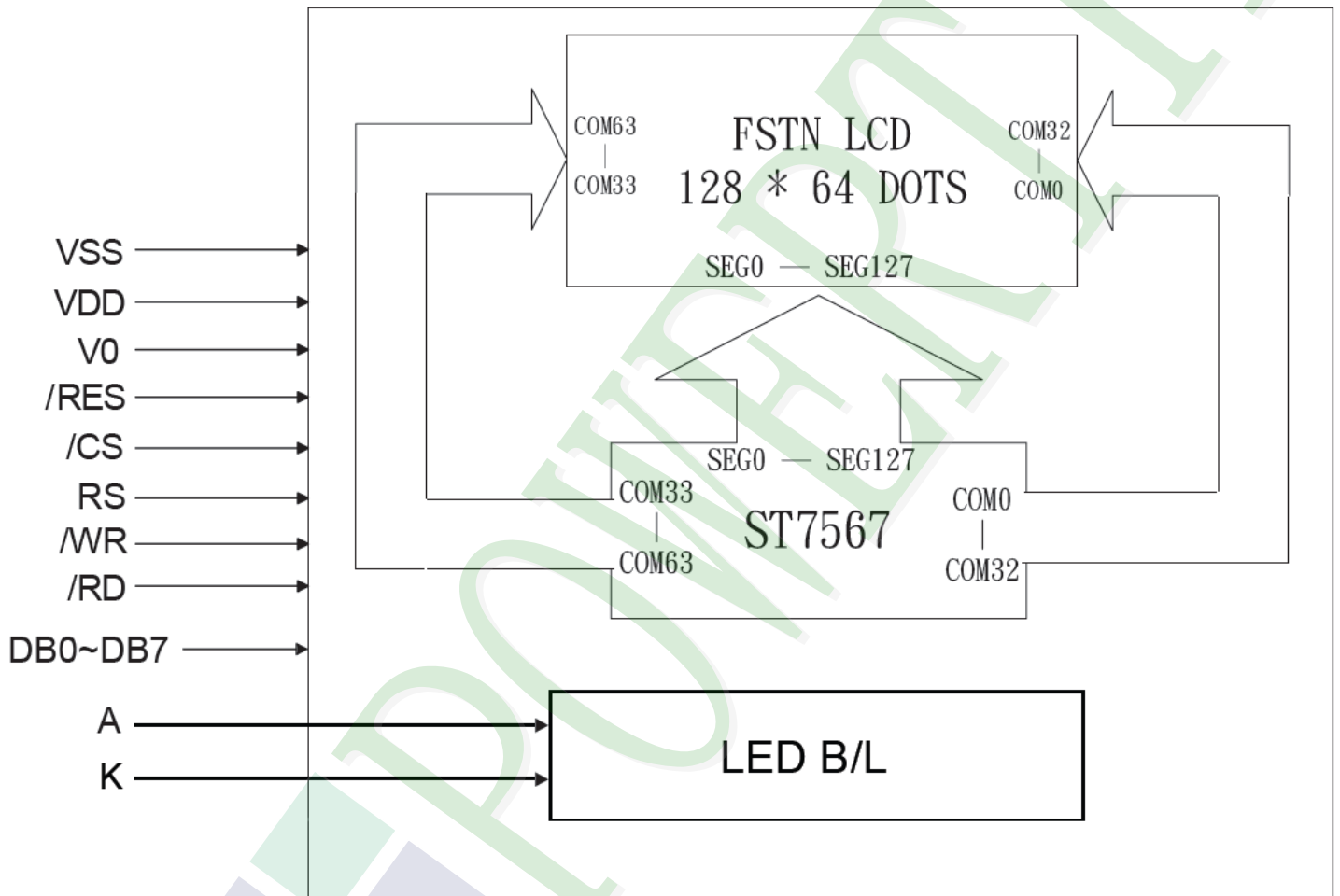

## 2.2 Interface Pin Description

Pin No.	Symbol	Function
1	VSS	Power Supply (VSS=0)
2	VDD	Power Supply (VDD>VSS)
3	V0	NO Connection
4	/RES	Controller reset (module reset)
5	/CS	Used to enter chip select signal
6	RS	Select control data or display data for read/write operation “L”=control data “H”=display data
7	/WR	Must be connected to VDD
8	/RD	Must be connected to VDD
9	DB0	Must be connected to VDD
10	DB1	Must be connected to VDD
11	DB2	Must be connected to VDD
12	DB3	Must be connected to VDD
13	DB4	Must be connected to VDD
14	DB5	Must be connected to VDD
15	DB6(SCL)	Serial data input
16	DB7(SDA)	serial clock input
17	A	Power supply LED backlight(+)
18	K	Power supply LED backlight(-)

## 2.3 Timing Characteristics

### System Bus Timing for 4-Line Serial Interface

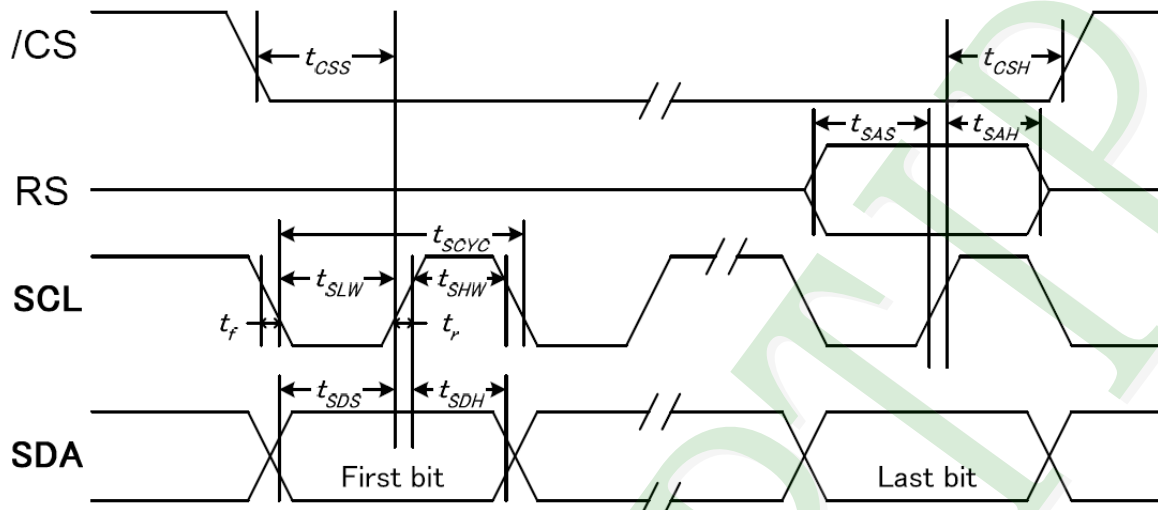

(VDD = 3.3V , Ta = -30~85°C)

Item	Signal	Symbol	Condition	Min.	Max.	Unit
Serial clock period	SCL	tSCYC		50	—	ns
SCLK "H" pulse width		tSHW		25	—	
SCLK "L" pulse width		tSLW		25	—	
Address setup time	RS	tSAS		20	—	
Address hold time		tSAH		10	—	
Data setup time	SDA	tSDS		20	—	
Data hold time		tSDH		10	—	
CSB-SCLK time	/CS	tCSS		20	—	
CSB-SCLK time		tCSH		40	—	

(VDD = 2.8V , Ta = -30~85°C)

Item	Signal	Symbol	Condition	Min.	Max.	Unit
Serial clock period	SCL	tSCYC		100	—	ns
SCLK "H" pulse width		tSHW		50	—	
SCLK "L" pulse width		tSLW		50	—	
Address setup time	RS	tSAS		30	—	
Address hold time		tSAH		20	—	
Data setup time	SDA	tSDS		30	—	
Data hold time		tSDH		20	—	
CSB-SCLK time	/CS	tCSS		30	—	
CSB-SCLK time		tCSH		60	—	

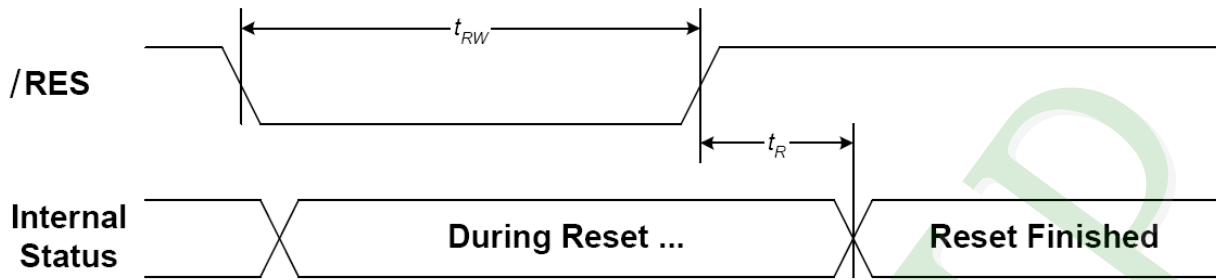
**Hardware Reset Timing**

(VDD = 3.3V , Ta = -30~85°C)

Item	Symbol	Condition	Min.	Max.	Unit
Reset time	tR		—	1.0	us
Reset "L" pulse width	tRW		1.0	—	

(VDD = 2.8V , Ta = -30~85°C)

Item	Symbol	Condition	Min.	Max.	Unit
Reset time	tR		—	2.0	us
Reset "L" pulse width	tRW		2.0	—	

## 2.4 Display command

INSTRUCTION	A0	R/W (RWR)	COMMAND BYTE								DESCRIPTION
			D7	D6	D5	D4	D3	D2	D1	D0	
(1) Display ON/OFF	0	0	1	0	1	0	1	1	1	D	D=1, display ON D=0, display OFF
(2) Set Start Line	0	0	0	1	S5	S4	S3	S2	S1	S0	Set display start line
(3) Set Page Address	0	0	1	0	1	1	Y3	Y2	Y1	Y0	Set page address
(4) Set Column Address	0	0	0	0	0	1	X7	X6	X5	X4	Set column address (MSB)
	0	0	0	0	0	0	X3	X2	X1	X0	Set column address (LSB)
(5) Read Status	0	1	0	MX	D	RST	0	0	0	0	Read IC Status
(6) Write Data	1	0	D7	D6	D5	D4	D3	D2	D1	D0	Write display data to RAM
(7) Read Data	1	1	D7	D6	D5	D4	D3	D2	D1	D0	Read display data from RAM
(8) SEG Direction	0	0	1	0	1	0	0	0	0	MX	Set scan direction of SEG MX=1, reverse direction MX=0, normal direction
(9) Inverse Display	0	0	1	0	1	0	0	1	1	INV	INV =1, inverse display INV =0, normal display
(10) All Pixel ON	0	0	1	0	1	0	0	1	0	AP	AP=1, set all pixel ON AP=0, normal display
(11) Bias Select	0	0	1	0	1	0	0	0	1	BS	Select bias setting 0=1/9; 1=1/7 (at 1/65 duty)
(12) Read-modify-Write	0	0	1	1	1	0	0	0	0	0	Column address increment: Read:+0 , Write:+1
(13) END	0	0	1	1	1	0	1	1	1	0	Exit Read-modify-Write mode
(14) RESET	0	0	1	1	1	0	0	0	1	0	Software reset
(15) COM Direction	0	0	1	1	0	0	MY	-	-	-	Set output direction of COM MY=1, reverse direction MY=0, normal direction
(16) Power Control	0	0	0	0	1	0	1	VB	VR	VF	Control built-in power circuit ON/OFF
(17) Regulation Ratio	0	0	0	0	1	0	0	RR2	RR1	RR0	Select regulation resistor ratio
(18) Set EV	0	0	1	0	0	0	0	0	0	1	Double command!! Set electronic volume (EV) level
	0	0	0	0	EV5	EV4	EV3	EV2	EV1	EV0	
(19) Set Booster	0	0	1	1	1	1	1	0	0	0	Double command!! Set booster level: 00=4X, 01=5X, 10=6X
	0	0	0	0	0	0	0	0	BL1	BL0	
(20) Power Save	0	0	Compound Command								Display OFF + All Pixel ON
(21) NOP	0	0	1	1	1	0	0	0	1	1	No operation
(22) Test	0	0	1	1	1	1	1	1	1	-	Do NOT use. Reserved for testing.

Note: Symbol “-” means this bit can be “H” or “L”.

## 2.5 Jumper

J1(2.3)/J2(2.3)/J3(2.3)/J6:SHORT;OTHER:OPEN



### 3. QUALITY ASSURANCE SYSTEM

#### 3.1 Quality Assurance Flow Chart

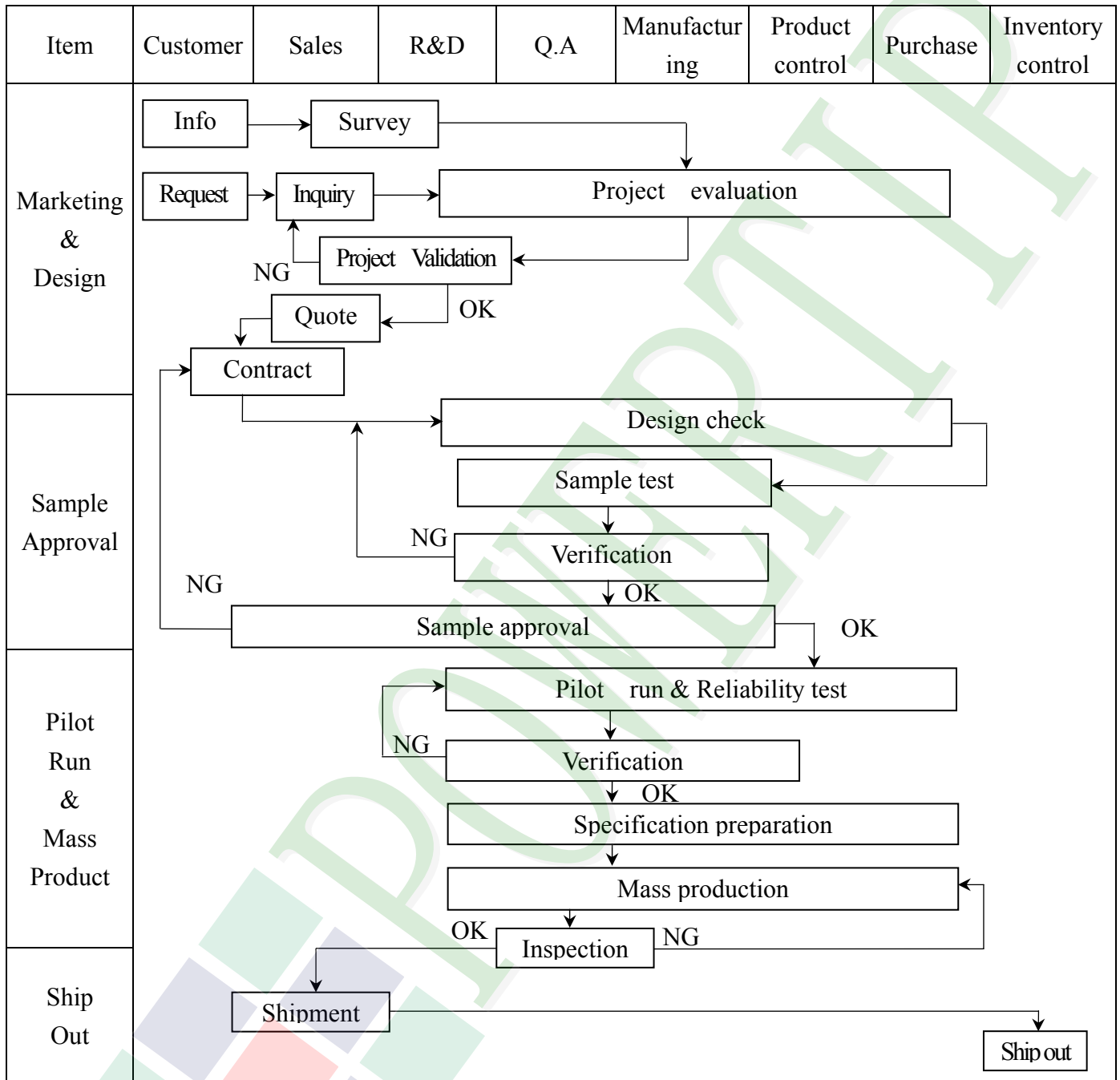

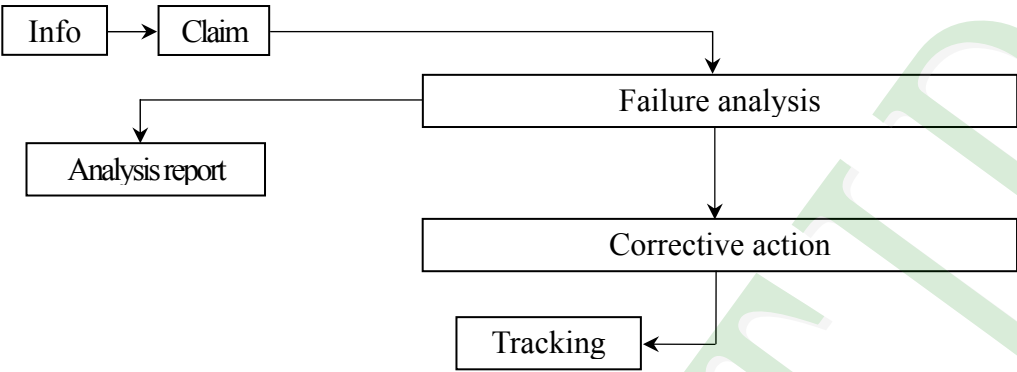
Item	Customer	Sales	R&D	Q.A	Manufacturing	Product control	Purchase	Inventory control
Sales Service	 <pre> graph TD     Info[Info] --&gt; Claim[Claim]     Claim --&gt; FA[Failure analysis]     Claim --&gt; AR[Analysis report]     FA --&gt; CA[Corrective action]     CA --&gt; Tracking[Tracking]         </pre>							
Q.A Activity	1. ISO 9001 Maintenance Activities 3. Equipment calibration 5. Standardization Management				2. Process improvement proposal 4. Education And Training Activities			

### 3.2 Inspection Specification

- ◆ **Scope** : The document shall be applied to LCD Module for Monotype and Color STN (Ver. 03).
- ◆ **Inspection Standard** : MIL-STD-105E Table Normal Inspection Single Sampling Level II .
- ◆ **Equipment** : Gauge 、 MIL-STD 、 Powertip Tester 、 Sample
- ◆ **Defect Level** : Major Defect AQL : 0.4 ; Minor Defect : AQL : 1.5 .
- ◆ **OUT Going Defect Level** : Sampling .
- ◆ **Manner of appearance test** :
  - (1). The test be under 20W×2 fluorescent light ' and distance of view must be at 30 cm.
  - (2). Standard of inspection : (Unit : mm)
  - (3). The test direction is base on about around 45° of vertical line. (Fig. 1)
  - (4). Definition of area . (Fig. 2)

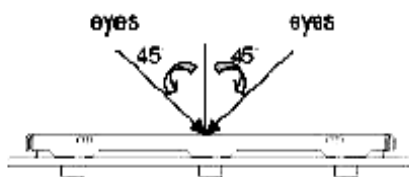

Fig.1

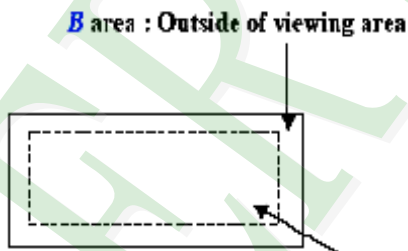

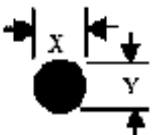

Fig. 2 A area : viewing area

#### ◆ Specification:

NO	Item	Criterion	level
01	Product condition	1. 1 The part number is inconsistent with work order of Production.	Major
		1. 2 Mixed production types.	Major
		1. 3 Assembled in inverse direction.	Major
02	Quantity	2. 1 The quantity is inconsistent with work order of production.	Major
03	Outline dimension	3. 1 Product dimension and structure must conform to Structure diagram.	Major
04	Electrical Testing	4. 1 Missing line character and icon.	Major
		4. 2 No function or no display.	Major
		4. 3 Output data is error.	Major
		4. 4 LCD viewing angle defect.	Major
		4. 5 Current consumption exceeds product specifications.	Major

**◆ Specification For Monotype and Color STN :**

(Ver. 03)

NO	Item	Criterion	level																																				
05	Black or white dot , scratch , contamination  Round type  $\Phi = (x+y)/2$  Line type 	5. 1 Round type: 5. 1. 1 display only : • White and black spots on display $\leq 0.30$ mm , no more than 4 white or black spots present. • Densely spaced : NO more than two spots or lines within 3 mm.  5. 1. 2 Non-display : <table border="1" data-bbox="502 660 1300 1019"> <thead> <tr> <th rowspan="2">Dimension (diameter : <math>\Phi</math>)</th> <th colspan="2">Acceptance (Q'ty)</th> </tr> <tr> <th>A area</th> <th>B area</th> </tr> </thead> <tbody> <tr> <td><math>\Phi \leq 0.10</math></td> <td colspan="2">Accept no dense</td> </tr> <tr> <td><math>0.10 &lt; \Phi \leq 0.20</math></td> <td>3</td> <td rowspan="3">Ignore</td> </tr> <tr> <td><math>0.20 &lt; \Phi \leq 0.30</math></td> <td>2</td> </tr> <tr> <td>Total quantity</td> <td>4</td> </tr> </tbody> </table> 5. 1. 3 Line type: <table border="1" data-bbox="454 1108 1348 1467"> <thead> <tr> <th colspan="2">Dimension</th> <th colspan="2">Acceptance (Q'ty)</th> </tr> <tr> <th>Length (L)</th> <th>Width (W)</th> <th>A area</th> <th>B area</th> </tr> </thead> <tbody> <tr> <td>---</td> <td><math>W \leq 0.03</math></td> <td>Accept no dense</td> <td rowspan="3">Ignore</td> </tr> <tr> <td><math>L \leq 3.0</math></td> <td><math>0.03 &lt; W \leq 0.05</math></td> <td rowspan="2">4</td> </tr> <tr> <td><math>L \leq 2.5</math></td> <td><math>0.05 &lt; W \leq 0.075</math></td> </tr> <tr> <td>---</td> <td><math>W &gt; 0.075</math></td> <td colspan="2">As round type</td> </tr> </tbody> </table>	Dimension (diameter : $\Phi$ )	Acceptance (Q'ty)		A area	B area	$\Phi \leq 0.10$	Accept no dense		$0.10 < \Phi \leq 0.20$	3	Ignore	$0.20 < \Phi \leq 0.30$	2	Total quantity	4	Dimension		Acceptance (Q'ty)		Length (L)	Width (W)	A area	B area	---	$W \leq 0.03$	Accept no dense	Ignore	$L \leq 3.0$	$0.03 < W \leq 0.05$	4	$L \leq 2.5$	$0.05 < W \leq 0.075$	---	$W > 0.075$	As round type		Minor
Dimension (diameter : $\Phi$ )	Acceptance (Q'ty)																																						
	A area	B area																																					
$\Phi \leq 0.10$	Accept no dense																																						
$0.10 < \Phi \leq 0.20$	3	Ignore																																					
$0.20 < \Phi \leq 0.30$	2																																						
Total quantity	4																																						
Dimension		Acceptance (Q'ty)																																					
Length (L)	Width (W)	A area	B area																																				
---	$W \leq 0.03$	Accept no dense	Ignore																																				
$L \leq 3.0$	$0.03 < W \leq 0.05$	4																																					
$L \leq 2.5$	$0.05 < W \leq 0.075$																																						
---	$W > 0.075$	As round type																																					
06	Polarizer Bubble	<table border="1" data-bbox="454 1534 1348 1937"> <thead> <tr> <th rowspan="2">Dimension (diameter : <math>\Phi</math>)</th> <th colspan="2">Acceptance (Q'ty)</th> </tr> <tr> <th>A area</th> <th>B area</th> </tr> </thead> <tbody> <tr> <td><math>\Phi \leq 0.20</math></td> <td colspan="2">Accept no dense</td> </tr> <tr> <td><math>0.20 &lt; \Phi \leq 0.50</math></td> <td>3</td> <td rowspan="3">Ignore</td> </tr> <tr> <td><math>0.50 &lt; \Phi \leq 1.00</math></td> <td>2</td> </tr> <tr> <td><math>\Phi &gt; 1.00</math></td> <td>0</td> </tr> <tr> <td>Total quantity</td> <td>4</td> <td></td> </tr> </tbody> </table>	Dimension (diameter : $\Phi$ )	Acceptance (Q'ty)		A area	B area	$\Phi \leq 0.20$	Accept no dense		$0.20 < \Phi \leq 0.50$	3	Ignore	$0.50 < \Phi \leq 1.00$	2	$\Phi > 1.00$	0	Total quantity	4		Minor																		
Dimension (diameter : $\Phi$ )	Acceptance (Q'ty)																																						
	A area	B area																																					
$\Phi \leq 0.20$	Accept no dense																																						
$0.20 < \Phi \leq 0.50$	3	Ignore																																					
$0.50 < \Phi \leq 1.00$	2																																						
$\Phi > 1.00$	0																																						
Total quantity	4																																						

**◆ Specification For Monotype and Color STN :**
**(Ver. 03)**

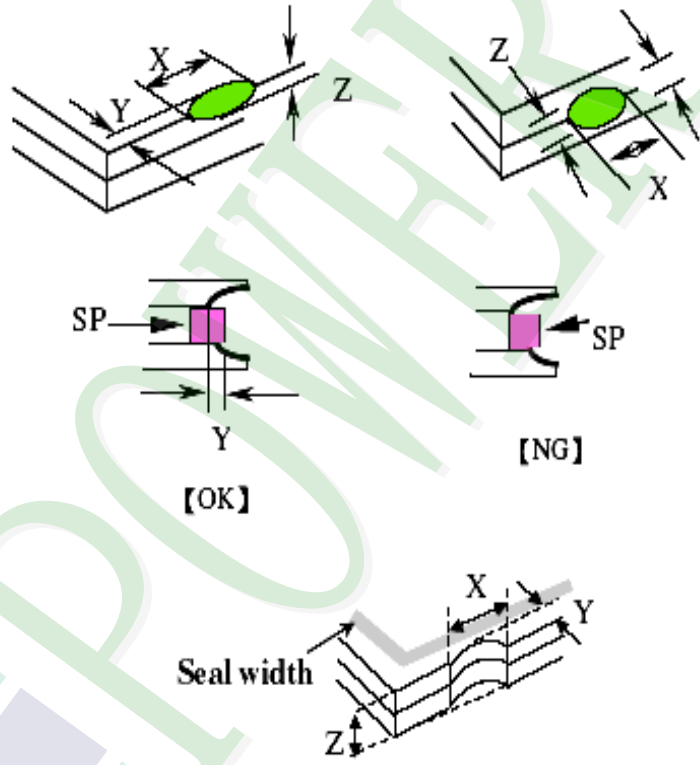
NO	Item	Criterion	Level									
07	The crack of glass	<p><b>Symbols :</b></p> <p><b>X :</b> The length of crack  <b>Z :</b> The thickness of crack  <b>t :</b> The thickness of glass</p> <p><b>Y :</b> The width of crack.  <b>W :</b> terminal length  <b>a :</b> LCD side length</p> <hr/> <p><b>7.1 General glass chip :</b>  <b>7.1.1 Chip on panel surface and crack between panels:</b></p>  <p>The diagrams illustrate various crack and chip scenarios. The top row shows two 3D views of a glass chip on a panel surface, with labels X (length), Y (width), and Z (thickness). The middle row shows two cross-sectional views of a crack between panels, with labels SP (sealant) and Y (crack width). The left view is labeled [OK] and the right view is labeled [NG]. The bottom diagram shows a crack at a panel edge with labels X, Y, Z, and Seal width.</p> <table border="1" data-bbox="510 1624 1284 1948"> <thead> <tr> <th>X</th> <th>Y</th> <th>Z</th> </tr> </thead> <tbody> <tr> <td><math>\leq a</math></td> <td>Crack can't enter viewing area</td> <td><math>\leq 1/2 t</math></td> </tr> <tr> <td><math>\leq a</math></td> <td>Crack can't exceed the half of SP width.</td> <td><math>1/2 t &lt; Z \leq 2 t</math></td> </tr> </tbody> </table>	X	Y	Z	$\leq a$	Crack can't enter viewing area	$\leq 1/2 t$	$\leq a$	Crack can't exceed the half of SP width.	$1/2 t < Z \leq 2 t$	Minor
X	Y	Z										
$\leq a$	Crack can't enter viewing area	$\leq 1/2 t$										
$\leq a$	Crack can't exceed the half of SP width.	$1/2 t < Z \leq 2 t$										

**◆ Specification For Monotype and Color STN :**
**(Ver. 03)**

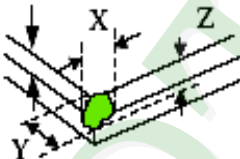
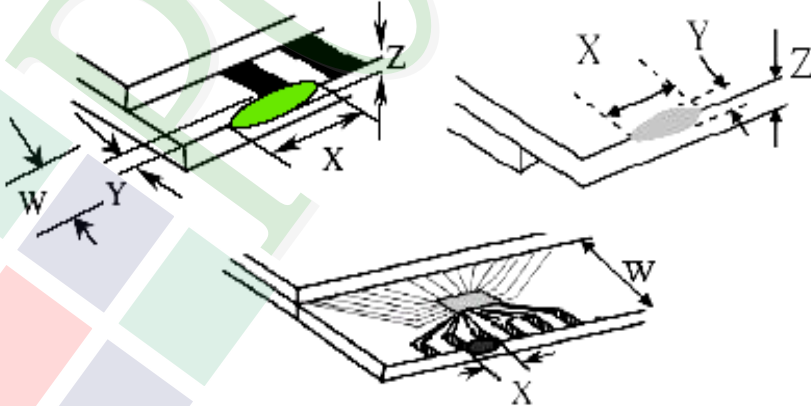
NO	Item	Criterion	Level									
07	The crack of glass	<p>Symbols :</p> <p>X : The length of crack                      Y : The width of crack.                      Z : The thickness of crack                      W : terminal length                      t : The thickness of glass                      a : LCD side length</p> <hr/> <p>7.1.2 Corner crack :</p>  <table border="1" data-bbox="509 855 1297 1171"> <thead> <tr> <th>X</th> <th>Y</th> <th>Z</th> </tr> </thead> <tbody> <tr> <td><math>\leq 1/5 a</math></td> <td>Crack can't enter viewing area</td> <td><math>Z \leq 1/2 t</math></td> </tr> <tr> <td><math>\leq 1/5 a</math></td> <td>Crack can't exceed the half of SP width.</td> <td><math>1/2 t &lt; Z \leq 2 t</math></td> </tr> </tbody> </table>	X	Y	Z	$\leq 1/5 a$	Crack can't enter viewing area	$Z \leq 1/2 t$	$\leq 1/5 a$	Crack can't exceed the half of SP width.	$1/2 t < Z \leq 2 t$	Minor
		X	Y	Z								
$\leq 1/5 a$	Crack can't enter viewing area	$Z \leq 1/2 t$										
$\leq 1/5 a$	Crack can't exceed the half of SP width.	$1/2 t < Z \leq 2 t$										
<p>7.2 Protrusion over terminal :</p> <p>7.2.1 Chip on electrode pad :</p>  <table border="1" data-bbox="475 1798 1238 1984"> <thead> <tr> <th></th> <th>X</th> <th>Y</th> <th>Z</th> </tr> </thead> <tbody> <tr> <td>Front</td> <td><math>\leq a</math></td> <td><math>\leq 1/2 W</math></td> <td><math>\leq t</math></td> </tr> <tr> <td>Back</td> <td colspan="3">Neglect</td> </tr> </tbody> </table>		X	Y	Z	Front	$\leq a$	$\leq 1/2 W$	$\leq t$	Back	Neglect		
	X	Y	Z									
Front	$\leq a$	$\leq 1/2 W$	$\leq t$									
Back	Neglect											

**◆ Specification For Monotype and Color STN :**

(Ver. 03)

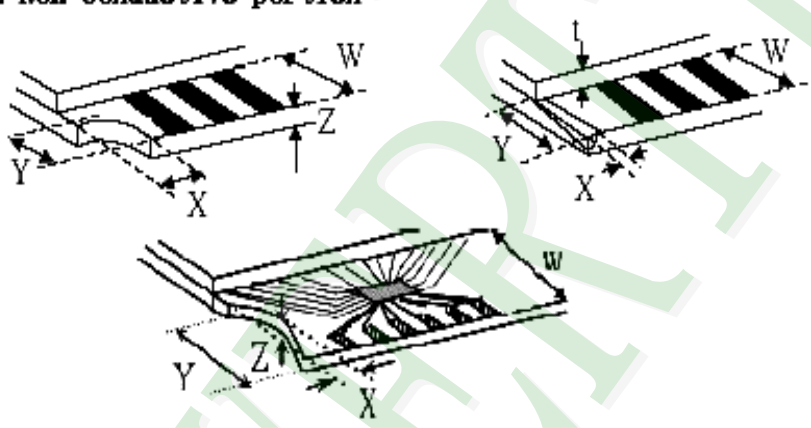
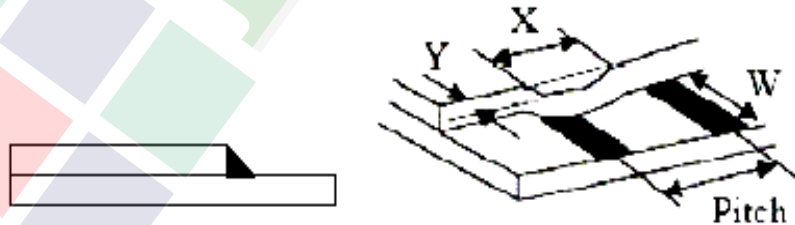
NO	Item	Criterion	Level									
07	The crack of glass	<p><b>Symbols :</b></p> <p><b>X :</b> The length of crack  <b>Z :</b> The thickness of crack  <b>t :</b> The thickness of glass</p> <p><b>Y :</b> The width of crack.  <b>W :</b> terminal length  <b>a :</b> LCD side length</p>	Minor									
		<p><b>7.2.2 Non-conductive portion :</b></p>  <table border="1" data-bbox="582 1108 1197 1276"> <thead> <tr> <th>X</th> <th>Y</th> <th>Z</th> </tr> </thead> <tbody> <tr> <td><math>\leq 1/3 a</math></td> <td><math>\leq W</math></td> <td><math>\leq t</math></td> </tr> </tbody> </table> <p>⊙ If the chipped area touches the ITO terminal, over 2/3 of the ITO must remain and be inspected according to electrode terminal specifications.</p> <p><b>7.2.3 Glass remain :</b></p>  <table border="1" data-bbox="502 1848 1181 2004"> <thead> <tr> <th>X</th> <th>Y</th> <th>Z</th> </tr> </thead> <tbody> <tr> <td><math>\leq a</math></td> <td><math>\leq 1/3 W</math></td> <td><math>\leq t</math></td> </tr> </tbody> </table>		X	Y	Z	$\leq 1/3 a$	$\leq W$	$\leq t$	X	Y	Z
X	Y	Z										
$\leq 1/3 a$	$\leq W$	$\leq t$										
X	Y	Z										
$\leq a$	$\leq 1/3 W$	$\leq t$										

**◆Specification For Monotype and Color STN :**
**(Ver. 03)**

NO	Item	Criterion	Level
08	Backlight elements	8. 1 Backlight can't work normally.	Major
		8. 2 Backlight doesn't light or color is wrong.	Major
		8. 3 Illumination source flickers when lit.	Major
09	General appearance	9. 1 Pin type must match type in specification sheet.	Major
		9. 2 No short circuits in components on PCB or FPC.	Major
		9. 3 Product packaging must the same as specified on packaging specification sheet.	Minor
		9. 4 The folding and peeled off in polarizer are not acceptable.	Minor
		9. 5 The PCB or FPC between B/L assembled distance (PCB or FPC) is $\leq 1.5$ mm.	Minor



## 4. RELIABILITY TEST

### 4.1 Reliability Test Condition

NO.	TEST ITEM	TEST CONDITION										
1	High Temperature Storage Test	Keep in 80 ±2°C 96 hrs Surrounding temperature, then storage at normal condition 4hrs										
2	Low Temperature Storage Test	Keep in -30 ±2°C 96 hrs Surrounding temperature, then storage at normal condition 4hrs										
3	High Humidity Storage	Keep in +60°C/90%RH duration for 96 hrs Surrounding temperature, then storage at normal condition 4hrs (Excluding the polarizer)										
4	ESD Test	Air Discharge: Apply 2 KV with 5 times Discharge for each polarity +/-										
		Contact Discharge: Apply 250V with 5 times discharge for each polarity +/-										
4	ESD Test	1. Temperature Ambient:15°C ~ 35°C 2. Humidity relative:30%~60% 3. Energy Storage Capacitance(Cs+Cd):150pF±10% 4. Discharge Resistance(Rd):330 Ω±10% 5. Discharge, mode of operation: Single Discharge (time between successive discharges at least 1 s) (Tolerance If the output voltage indication: ±5%)										
5	Temperature Cycling Test	$  \begin{array}{c}  -20^{\circ}\text{C} \rightarrow 25^{\circ}\text{C} \rightarrow 70^{\circ}\text{C} \rightarrow 25^{\circ}\text{C} \\  \text{(30mins) (5mins) (30mins) (5mins)} \\  \longleftarrow \hspace{10em} \longrightarrow \\  \text{10 Cycle}  \end{array}  $ Surrounding temperature, then storage at normal condition 4hrs										
6	Vibration Test (Packaged)	1. Sine wave 10~55HZ frequency (1 min) 2. The amplitude of vibration :1.5 mm 3. Each direction (XYZ) duration for 2 Hrs										
7	Drop Test (Packaged)	<table border="1"> <thead> <tr> <th>Packing Weight (Kg)</th> <th>Drop Height (cm)</th> </tr> </thead> <tbody> <tr> <td>0 ~ 45.4</td> <td>122</td> </tr> <tr> <td>45.4 ~ 90.8</td> <td>76</td> </tr> <tr> <td>90.8 ~ 454</td> <td>61</td> </tr> <tr> <td>Over 454</td> <td>46</td> </tr> </tbody> </table>	Packing Weight (Kg)	Drop Height (cm)	0 ~ 45.4	122	45.4 ~ 90.8	76	90.8 ~ 454	61	Over 454	46
		Packing Weight (Kg)	Drop Height (cm)									
		0 ~ 45.4	122									
		45.4 ~ 90.8	76									
		90.8 ~ 454	61									
Over 454	46											
Drop direction :※3 comer /1 edges /6 sides etch 1times												

## **5. PRECAUTION RELATING PRODUCT HANDLING**

### **5.1 SAFETY**

- 5.1.1 If the LCD panel breaks , be careful not to get the liquid crystal to touch your skin.
- 5.1.2 If the liquid crystal touches your skin or clothes , please wash it off immediately by using soap and water.

### **5.2 HANDLING**

- 5.2.1 Avoid any strong mechanical shock which can break the glass.
- 5.2.2 Avoid static electricity which can damage the CMOS LSI—When working with the module , be sure to ground your body and any electrical equipment you may be using.
- 5.2.3 Do not remove the panel or frame from the module.
- 5.2.4 The polarizing plate of the display is very fragile. So , please handle it very carefully ,do not touch , push or rub the exposed polarizing with anything harder than an HB pencil lead (glass , tweezers , etc.)
- 5.2.5 Do not wipe the polarizing plate with a dry cloth , as it may easily scratch the surface of plate.
- 5.2.6 Do not touch the display area with bare hands , this will stain the display area.
- 5.2.7 Do not use ketonics solvent & aromatic solvent. Use with a soft cloth soaked with a cleaning naphtha solvent.
- 5.2.8 To control temperature and time of soldering is  $320\pm 10^{\circ}\text{C}$  and 3-5 sec.
- 5.2.9 To avoid liquid (include organic solvent) stained on LCM .

### **5.3 STORAGE**

- 5.3.1 Store the panel or module in a dark place where the temperature is  $25^{\circ}\text{C} \pm 5^{\circ}\text{C}$  and the humidity is below 65% RH.
- 5.3.2 Do not place the module near organics solvents or corrosive gases.
- 5.3.3 Do not crush , shake , or jolt the module.

### **5.4 TERMS OF WARRANTY**

- 5.4.1 Applicable warrant period  
The period is within thirteen months since the date of shipping out under normal using and storage conditions.
- 5.4.2 Unaccepted responsibility  
This product has been manufactured to your company's specification as a part for use in your company's general electronic products. It is guaranteed to perform according to delivery specifications. For any other use apart from general electronic equipment , we cannot take responsibility if the product is used in nuclear power control equipment , aerospace equipment , fire and security systems or any other applications in which there is a direct risk to human life and where extremely high levels of reliability are required.

A B C D E F G H

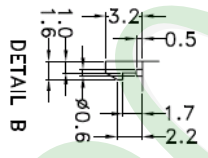
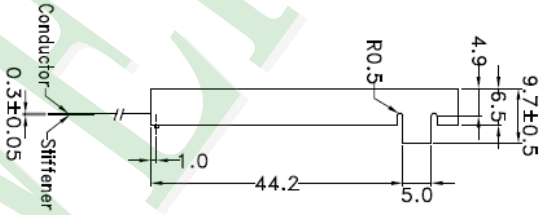
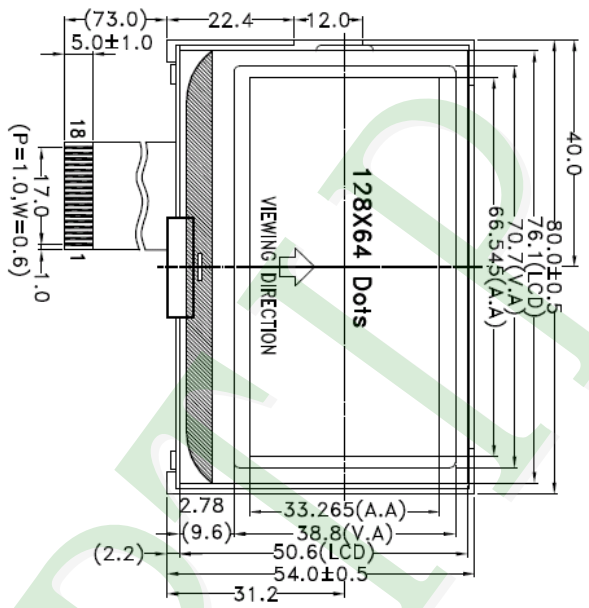

SCALE:2/1

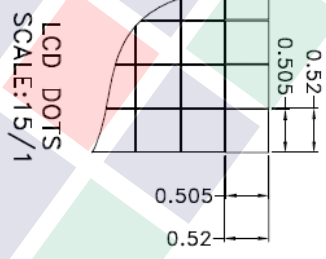
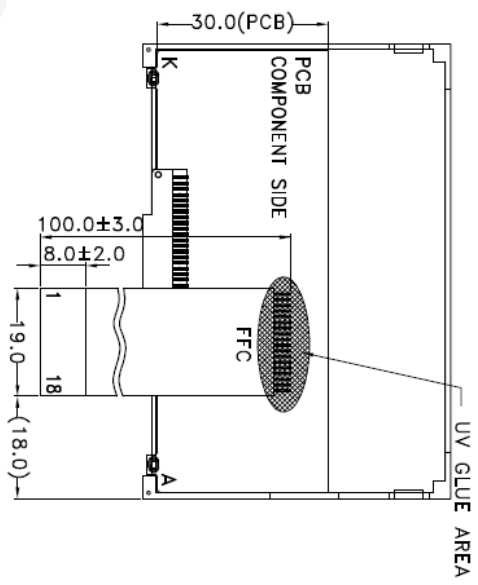

LCD DOTS  
SCALE:15/1

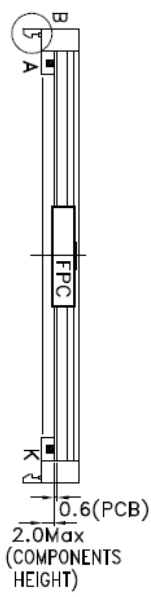

- NOTES:
- 1.LCD type:STN, Positive, Transflective.
  - 2.Viewing direction:6H;
  - 3.Top:-20°C~70°C, Tst:-30°C~80°C;
  - 4.IC:ST7567 or comparable driver IC
  - 5.The tolerance unless classified ±0.3mm;
  - 6.This product conforms ROHS.

007		PART NO:	PE 12864LRF-042-H-Q	<p>久正光电股份有限公司 POWER TIP TECHNOLOGY CORPORATION</p>	Design	Hu Guangwei huang.jiefeng		Surface			Material			Length(mm)	1 ~ 4		Precision Level
006		DRAWING NAME:	HLM-D-PE12864LRF-042-H-Q		Check	Zhou Aimei		Unit	MM		Thickness	4 ~ 16		63 ~ 63			
005		TITLE:	LCD MODULE DRAWING		Approve	Cai Zhichuan	Scale	1:1	Quantity	16 ~ 250	63 ~ 250						
004							Page	1/1		250 ~ 1000							
003																	
002																	
001																	
REV		NEW DRAWING	REV BY	HU GUANGWEI	REVISER	DATE	2009/03/23										

Ver.001

# LCM包裝規格書

## LCM Packaging Specifications

Documents NO. HPKG-PE12864LRF-042-H-Q

Approve	Check	Contact
caizhichuan	zhouamei	huguangwei huang jiefeng

### 1. 包裝材料規格表 (Packaging Material) : (per carton)

No.	Item	Model	Dimensions (mm)	1Pcs Weight	Quantity	Total Weight
1	成品 LCM	PE12864LRF-042-H-Q	80.0*54.0*9.7	0.03	192	5.76
2	靜電袋 (1)BAG	BAG150100ARABA	150*120*0.05	0.002	192	0.384
3	氣泡墊(2)BAG	BAG240100AWBBA	240*100*5	0.0015	192	0.288
4	氣泡墊(3)BAG	BAG290240BRBBA	240*290*5	0.0029	16	0.0464
5	刀卡A2(4)BX	BX29500072BZBA	295*72*3	0.011	104	1.144
6	刀卡B2(5)BX	BX24500072BZBA	245*72*3	0.01	24	0.24
7	C2內盒(6)Product Box	BX31025580AABA	310*255*86	0.221	8	1.768
8	外紙箱(7)Carton	BX52532536CCBA	525*325*360	1.092	1	1.092
9						

2. 一整箱總重量 (Total LCD Weight in carton) : 10.72 Kg±10%

3. 單箱數量規格表 (Packaging Specifications and Quantity) :

(1) LCM quantity per box : no. per box	12	x no. of box	2	=	24
(2) Total LCM quantity in carton : quantity per box	24	x no. of boxes	8	=	192

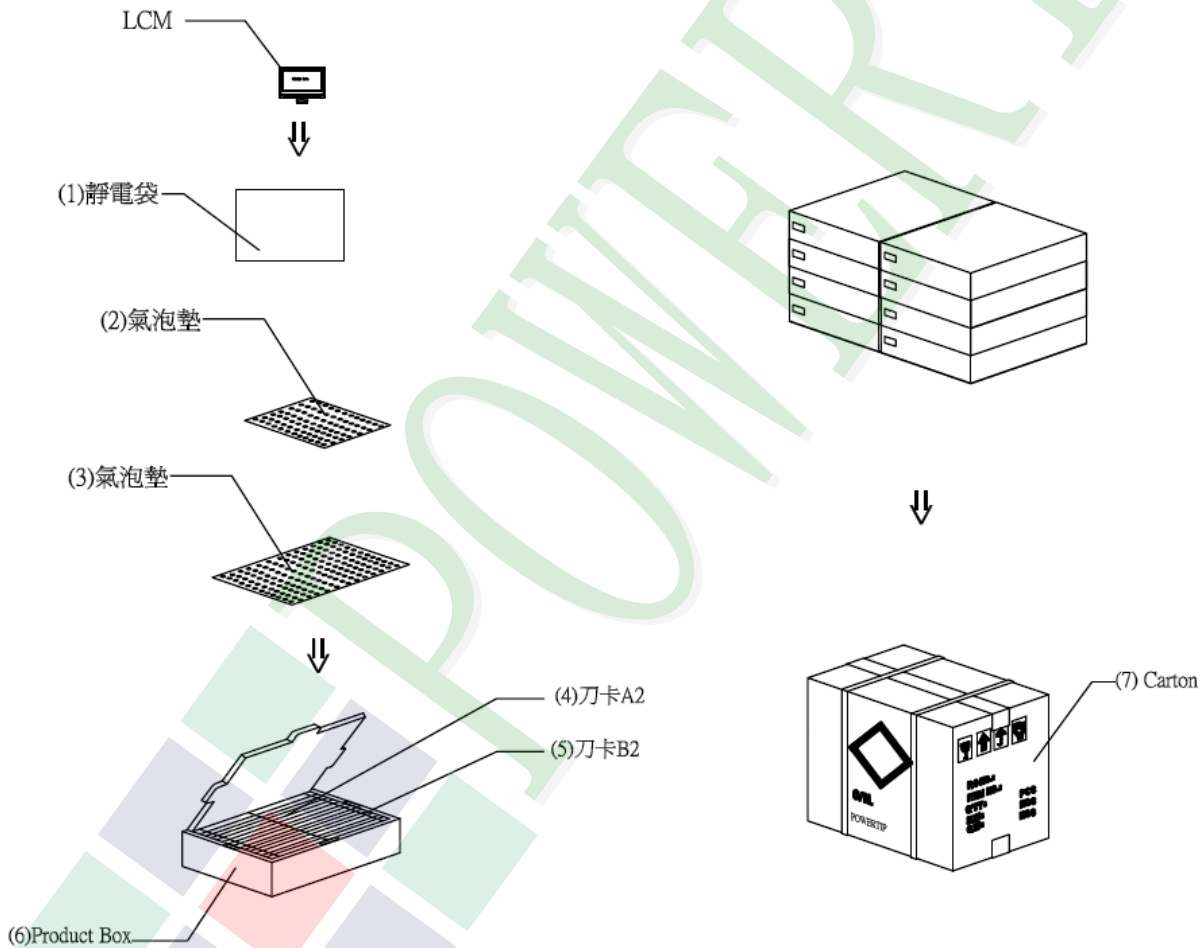

### 特 記 事 項 (REMARK)

#### 1. Label Specifications :

MODEL:  
LOT NO:  
QUANTITY:  
CHECK:

前后空一格