

RSHN SERIES

High-Attenuation Type Single-Phase Filter with Various Variations and Functions



FEATURES

- Self-tightening screws and an open/close type cover make wiring work easier.
- 3 to 300A wide range lineup.
- Optional low-leakage current characteristic type and DIN rail installation compatible type are also available.

SAFETY STANDARDS

UL1283	UL File No. E62388 (Up to 60A)
CSA C22.2 No.8	CSA File No. LR76849 (Up to 30A)
EN60939	Licence Ref. No. SE/07115-3 (Up to 60A)

PRODUCT IDENTIFICATION

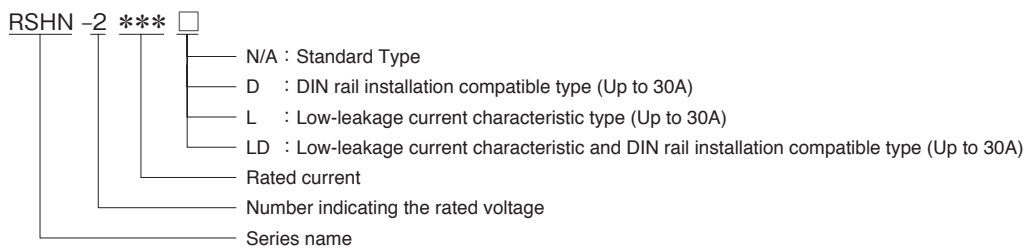

CONFORMITY TO RoHS Directive

CIRCUIT DIAGRAMS

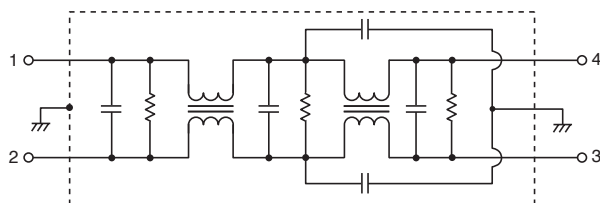

ELECTRICAL CHARACTERISTICS

Part No.	Rated voltage (AC/DC)	Rated current (AC/DC)	Withstand voltage	Insulation resistance	Leakage current	Operating temperature range	With derating over	DC resistance (mΩ)	Attenuation frequency range (MHz)			Weight (kg)
									Common mode		Differential mode	
									at 25dB	at 10dB	at 25dB	
RSHN-2003	250V	3A	AC.2500V 60s [Between line to ground]	100MΩ min. [DC.500V/ 1min]	1.0mA max. [250V/60Hz]	-25 to +85°C	55°C	350 max.	0.1 to 10	-	0.2 to 30	0.19
RSHN-2006		6A						140 max.	0.1 to 10	-	0.2 to 30	0.24
RSHN-2010		10A						60 max.	0.1 to 30	-	0.3 to 30	0.24
RSHN-2016		16A						35 max.	0.2 to 30	-	0.3 to 30	0.35
RSHN-2020		20A						22 max.	0.2 to 30	-	0.4 to 30	0.35
RSHN-2030		30A						12 max.	0.3 to 30	-	0.6 to 30	0.35
RSHN-2040		40A						10 max.	0.2 to 30	-	0.1 to 30	1.50
RSHN-2050		50A						8 max.	0.3 to 30	-	0.2 to 30	1.40
RSHN-2060		60A						6 max.	0.3 to 30	-	0.3 to 30	1.40
RSHN-2080		80A						7 max.	0.2 to 8	-	0.1 to 30	5.50
RSHN-2100		100A						6 max.	0.2 to 8	-	0.1 to 30	6.00
RSHN-2150		150A						4 max.	0.2 to 7	-	0.1 to 30	9.00
RSHN-2200		200A						3 max.	0.4 to 7	-	0.1 to 30	13.00
RSHN-2250		250A						2 max.	-	0.4 to 10	0.1 to 30	13.00
RSHN-2300	300A	1.5 max.	-	1 to 7	0.1 to 30	13.00						

Part No.	Rated voltage (AC/DC)	Rated current (AC/DC)	Withstand voltage	Insulation resistance	Leakage current	Operating temperature range	With derating over	DC resistance (mΩ)	Attenuation frequency range (MHz)		Weight (kg)
									Common mode	Differential mode	
									at 25dB	at 25dB	
RSHN-2003L	250V	3A	AC.2500V 60s [Between line to ground]	100MΩ min. [DC.500V/ 1min]	100μA max. [250V/60Hz]	-25 to +85°C	55°C	350 max.	0.2 to 10	0.2 to 30	0.19
RSHN-2006L		6A						140 max.	0.2 to 10	0.2 to 30	0.24
RSHN-2010L		10A						60 max.	0.3 to 10	0.3 to 30	0.24
RSHN-2016L		16A						35 max.	0.3 to 30	0.3 to 30	0.35
RSHN-2020L		20A						22 max.	0.4 to 30	0.4 to 30	0.35
RSHN-2030L		30A						12 max.	0.6 to 30	0.6 to 30	0.35

DERATING GRAPHS

RSHN-2003/2006/2010/2016/2020/2030/
2040/2050/2060

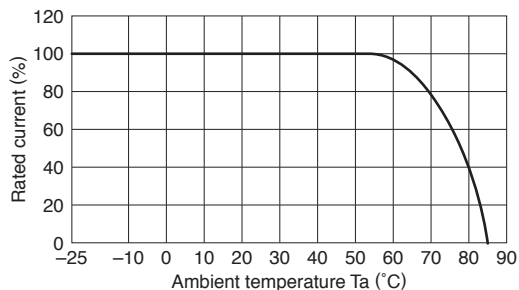

RSHN-2080/2100/2150/2200/2250/2300

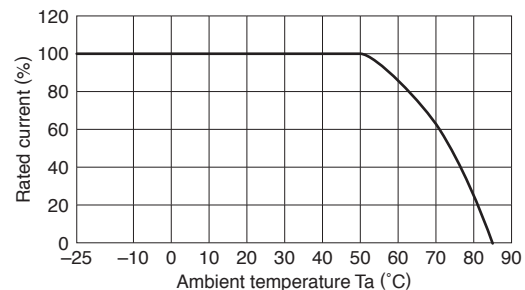

MECHANICAL

RSHN-2003/2006/2010/2016/2020/2030

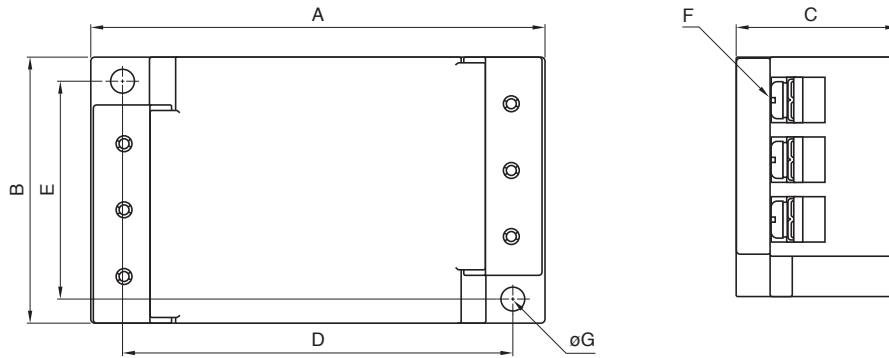

RSHN-2040/2050/2060/2080/2100/2150

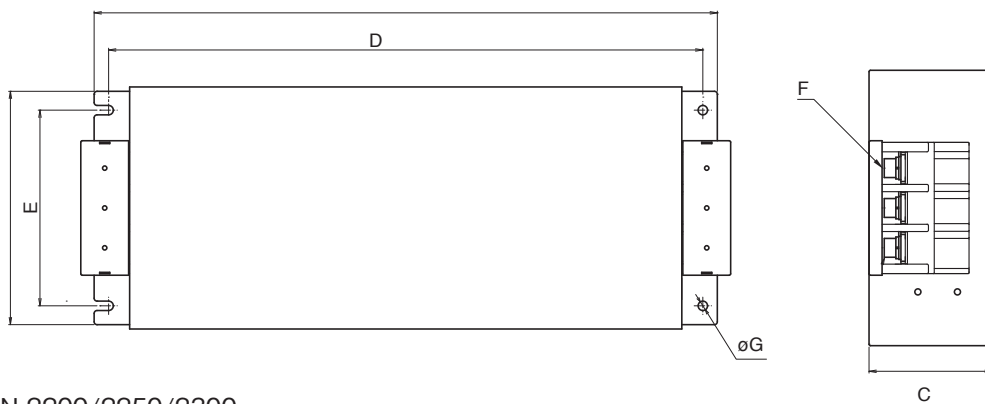

RSHN-2200/2250/2300

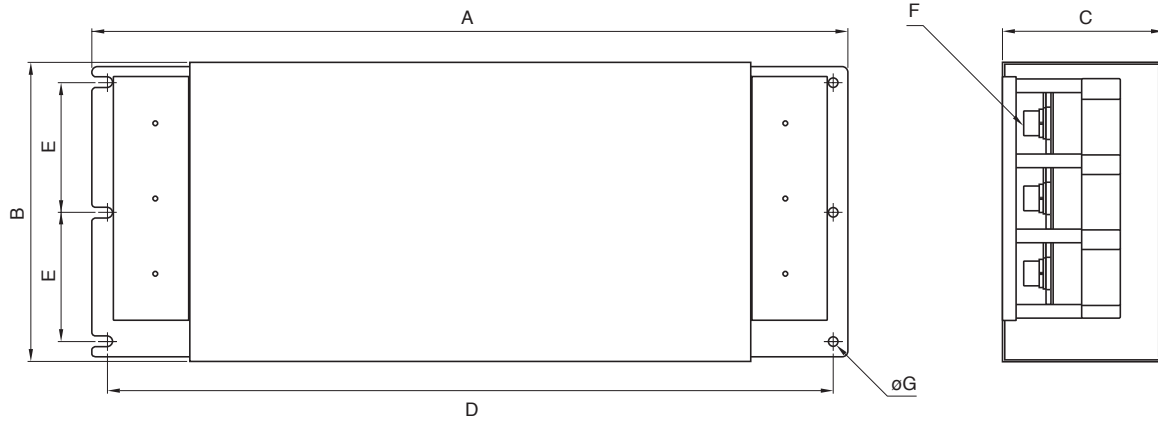

Dimensions in mm

Part No.	A	B	C	D	E	F	ϕG	Recommended clamping torque
RSHN-2003	98	52	35	86	43	M4	4.5	1.27N · m
RSHN-2006								
RSHN-2010								
RSHN-2016								
RSHN-2020	127	52	35	115	43	M4	4.5	1.27N · m
RSHN-2030								
RSHN-2040								
RSHN-2050	272	100	60	254	82	M5	5.5	2.5N · m
RSHN-2060								
RSHN-2080	430	161	85	410	135	M8	6.5	7.64N · m
RSHN-2100								
RSHN-2150								
RSHN-2200	593	195	103	573	84.5	M10	6.5	11.8N · m
RSHN-2250								
RSHN-2300								

RSHN-2003D/2006D/2010D

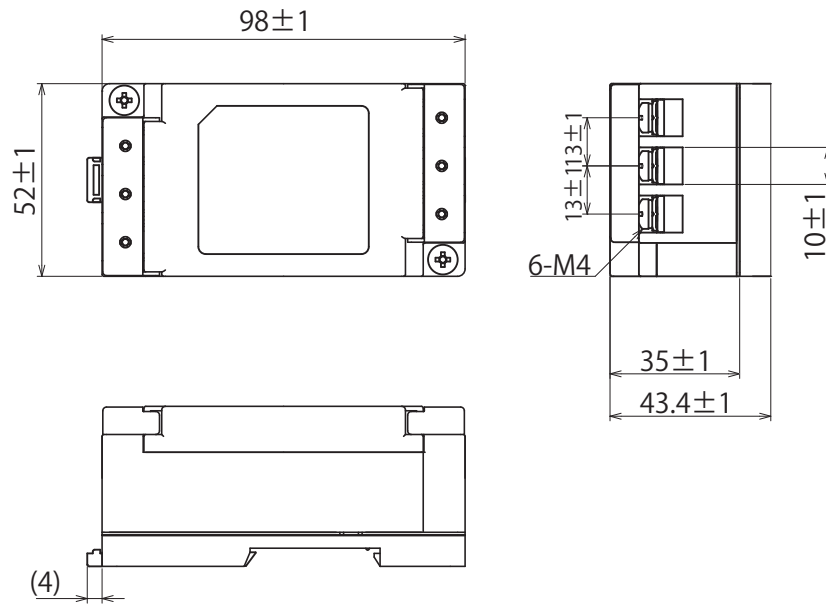

RSHN-2016D/2020D/2030D

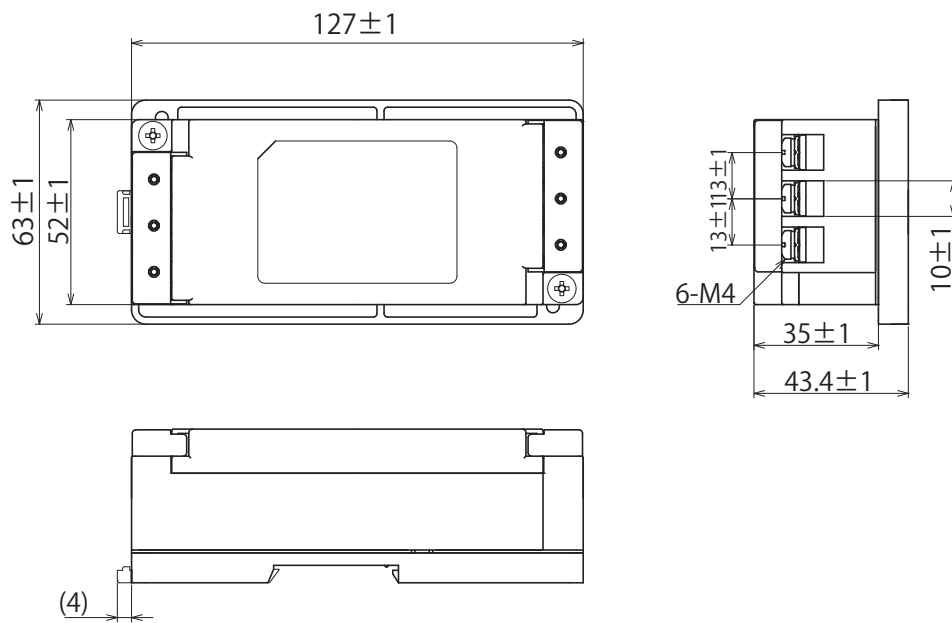

Dimensions in mm

ATTENUATION vs. FREQUENCY CHARACTERISTICS

RSHN-2003

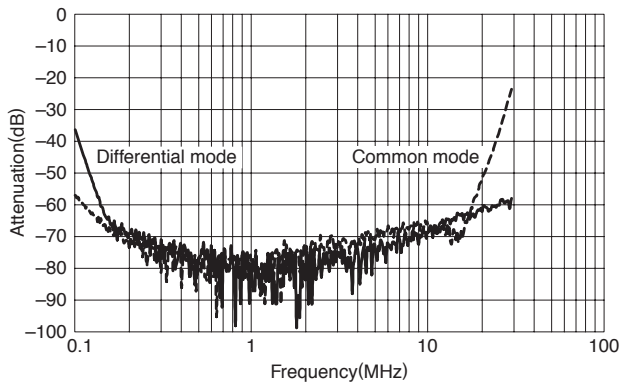

RSHN-2006

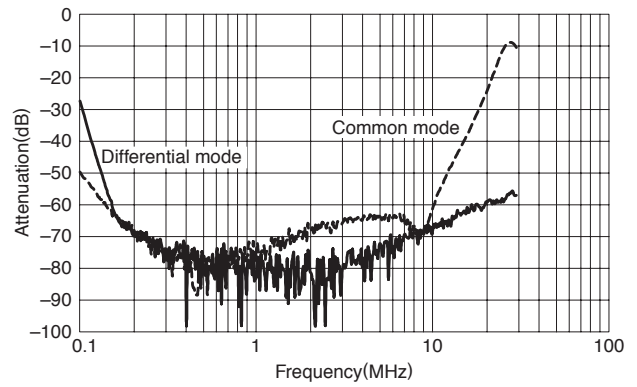

RSHN-2010

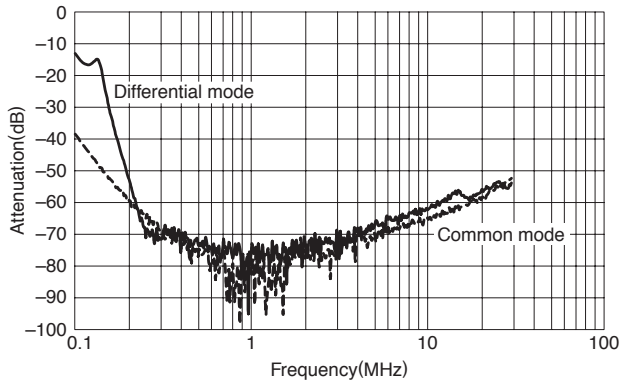

RSHN-2016

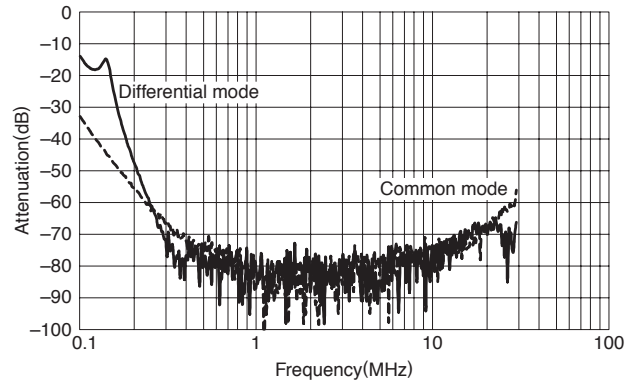

RSHN-2020

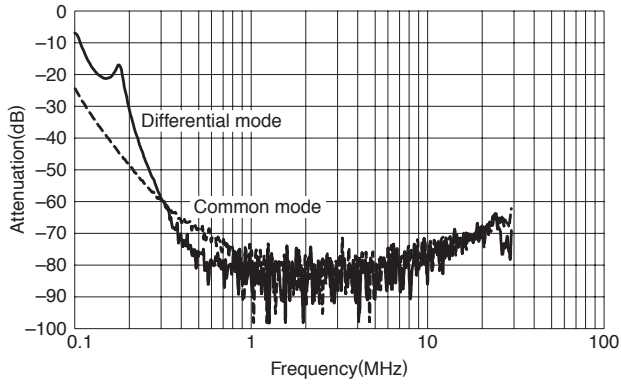

RSHN-2030

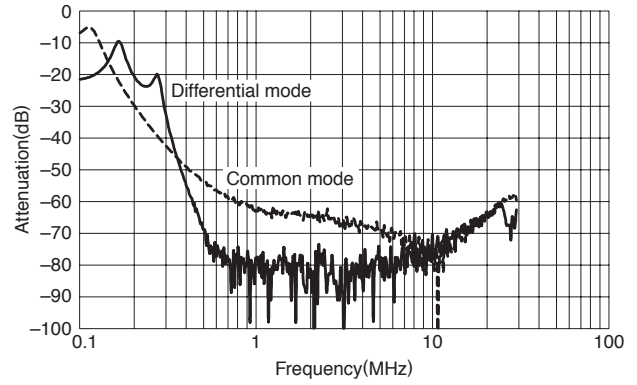

RSHN-2040

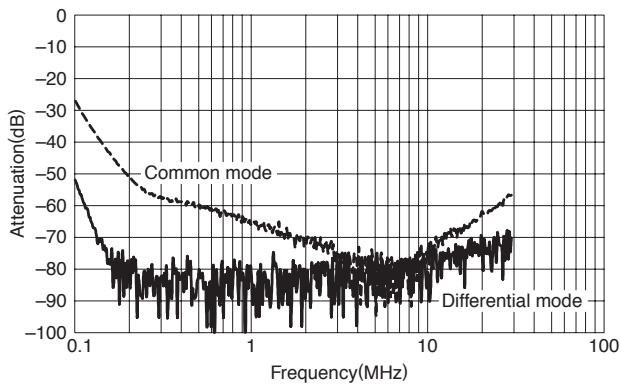

RSHN-2050

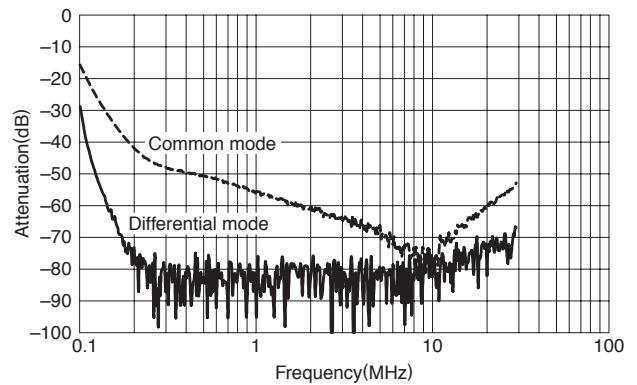

RSHN-2060

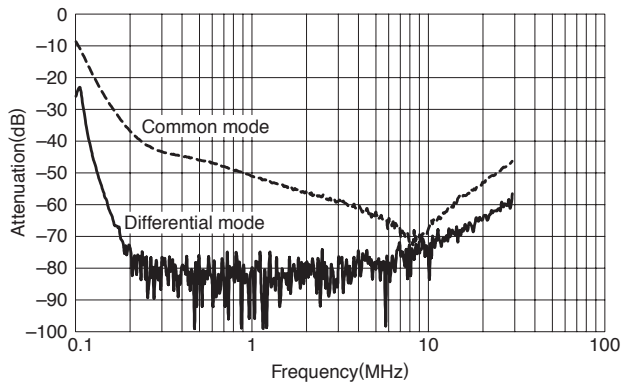

RSHN-2080

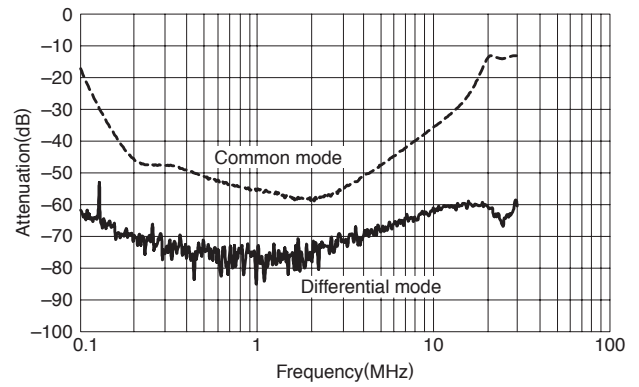

RSHN-2100

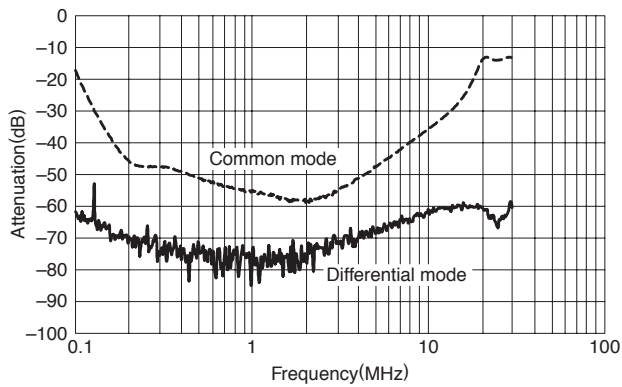

RSHN-2150

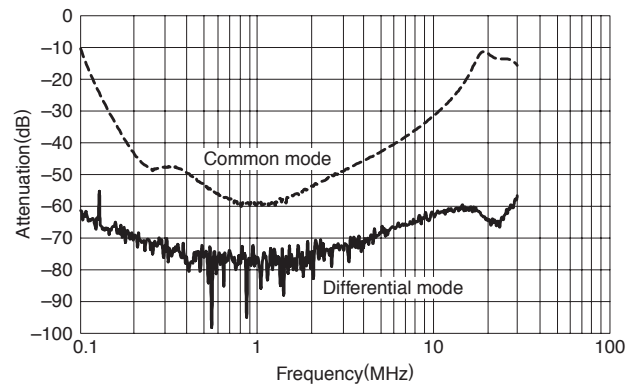

RSHN-2200

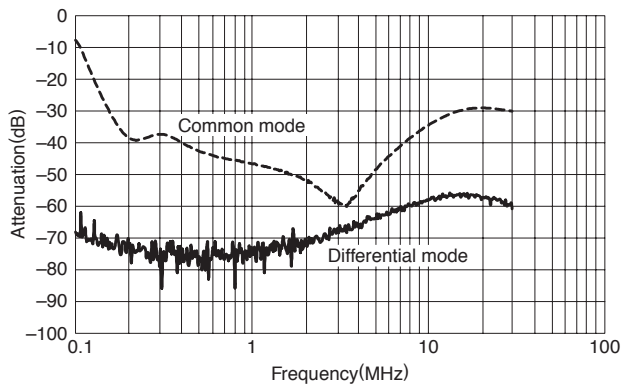

RSHN-2250

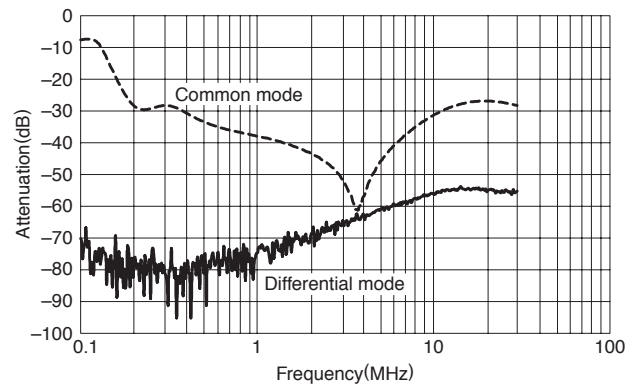

RSHN-2300

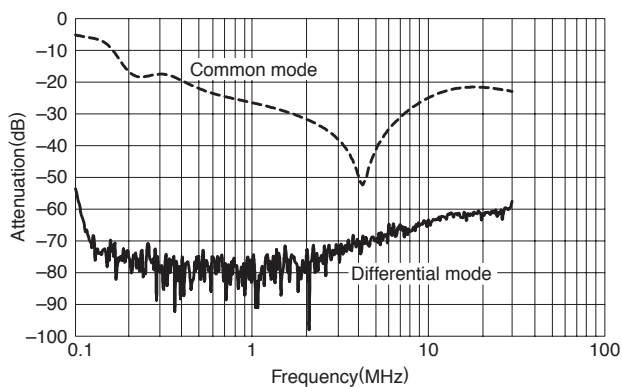

RSHN-2003L

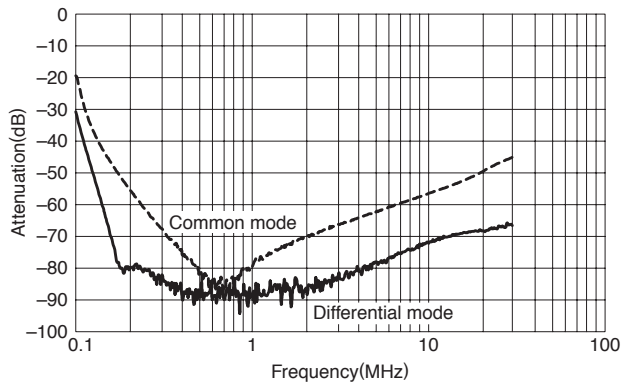

RSHN-2006L

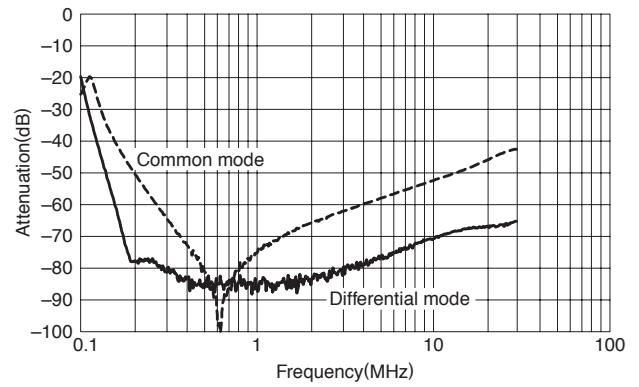

RSHN-2010L

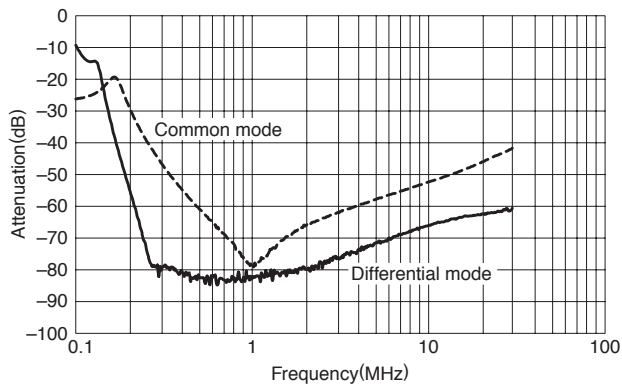

RSHN-2016L

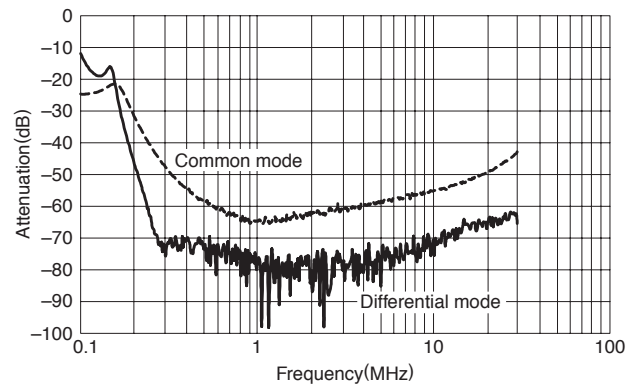

RSHN-2020L

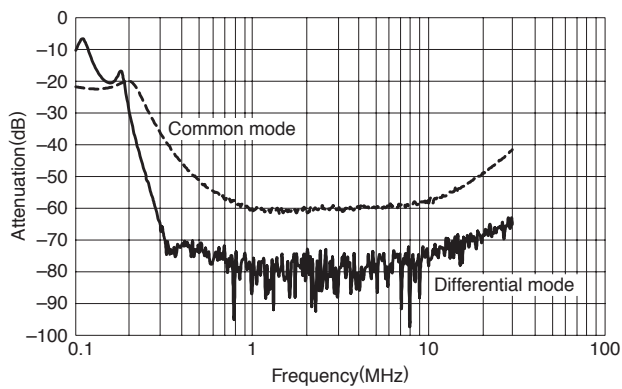

RSHN-2030L

