

HFD3-VI

SUBMINIATURE HIGH INSULATION RELAY



File No.:E133481



File No.: R 50433438



File No.: CQC19002231071

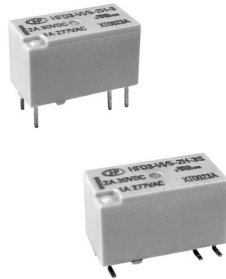

Features

- Third generation Signal relay
- 2 Form A and 2 Form C configurations
- High contact switching capacity: 10mA 1000VDC/1500VDC
- SMT and DIP types available
- Single side stable and latching type available
- 6kV surge withstand Voltage (between coil and contacts), Meet ITU-T K.21 requirement
- 2 pairs of NO contacts connected in series with contact gap $\geq 1.5\text{mm}$, product in accordance to IEC62776-1 available.

RoHS compliant

CONTACT DATA

Contact arrangement	2A/2C
Contact resistance ¹⁾	$\leq 100\text{m}\Omega$ (10mA 30mVDC)
Contact material	AgNi+ Au plated
Contact rating (Res. load)	2A 30VDC 1A 277VAC 10mA 1500VDC 10mA 1000VDC
Max. switching voltage	1100VAC/1500VDC(Two sets of open contacts in series) 600VAC/800VDC(Single contact)
Max. switching current	4A
Max. switching power	277VA / 60W
Min. applicable load ²⁾	10mV 10uA
Mechanical endurance	1 x 10 ⁷ OPS
Electrical endurance	1 x 10 ⁵ ops(Resistive load 85°C 2A 30VDC) 5 x 10 ⁴ ops(Resistive load 85°C 1A 277VAC) 5 x 10 ⁴ ops(Resistive load 105°C 10mA 1000VDC) ³⁾ 3 x 10 ⁴ ops(Resistive load 105°C 10mA 1500VDC) ³⁾

- Notes:** 1) The data shown above are initial values.
 2) Min. applicable load is reference value. Please perform the confirmation test with the actual load before production since reference value may change according to switching frequencies, environmental conditions and expected contact resistance and reliability.
 3) Two sets of open contacts or two sets of closed contacts in Series.
 Two sets of open contacts in Series.

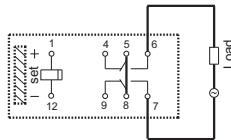

COIL

Coil power	Single side stable	Approx.200mW Approx.280mW ⁽²⁾
	1 coil latching	Approx.140mW Approx.200mW ⁽²⁾
Temperature rise	$\leq 90\text{K}$ (2A Resistive load 85°C environment)	

- Notes:** 1) The data shown above are initial values.
 2) Product with 907 suffix, meet ITU-T K.21 requirement on surge voltage.

CHARACTERISTICS

Insulation resistance		1000M Ω (500VDC)
Dielectric strength	Between open contacts	1500VAC 1min
	Between contact sets	1500VAC 1min
	Between coil&contact	4000VAC 1min
Surge withstand voltage		
Between open contacts (10/160 μs)		2.5kV
Between coil & contacts (1.2/50 μs)		6kV
Between coil & contacts (10/700 μs)		6kV ²⁾
Operate time (Set time)		$\leq 6\text{ms}$
Release time (Reset time)		$\leq 6\text{ms}$
Ambient temperature		-40°C to 85°C -40°C to 105°C ³⁾
Humidity		5% to 85% RH
Shock resistance	Functional	735m/s ²
	Destructive	980m/s ²
Vibration resistance	Functional	10Hz to 55Hz 3.3mm DA
	Destructive	10Hz to 55Hz 5.0mm DA
Termination		DIP、SMT
Unit weight		Approx.2g
Moisture sensitivity levels (Only for SMT type, JEDEC-STD-020)		MSL-3
Construction		Plastic

- Notes:** 1) The data shown above are initial values.
 2) Product with 907 suffix, meet ITU-T K.21 requirement on surge voltage.
 3) Product with 888 suffix is for application at 105°C.
 4) Please see more details in the ordering information.

SAFETY APPROVAL RATINGS

UL/CUL	AgNi+Au plated	2A 30VDC, at 85°C 1A 277VAC, at 85°C
TUV		10mA 1000VDC, at 105°C 10mA 1500VDC, at 105°C

Notes: Only typical loads are listed above. Other load specifications can be available upon request.



HONGFA RELAY

ISO9001, IATF16949, ISO14001, OHSAS18001, IECQ QC 080000 CERTIFIED

2023 Rev. 1.01

COIL DATA

at 23°C

Single side stable

Coil Code	Nominal Voltage VDC ¹⁾	Initial Pick-up Voltage VDC ¹⁾ max.	Initial Drop-out Voltage VDC min.	Coil Resistance Ω	Nominal Power mW approx.	Max. Voltage VDC ⁴⁾
HFD3-VI/1.5	1.5	1.13	0.15	11.2 x (1±10%)	200	3.0
HFD3-VI/2.4	2.4	1.8	0.24	28.8 x (1±10%)	200	4.8
HFD3-VI/3	3	2.25	0.3	45x (1±10%)	200	6.0
HFD3-VI/4.5	4.5	3.38	0.45	101 x (1±10%)	200	9.0
HFD3-VI/5	5	3.75	0.5	125 x (1±10%)	200	10
HFD3-VI/6	6	4.5	0.6	180 x (1±10%)	200	12
HFD3-VI/9	9	6.75	0.9	405x (1±10%)	200	18
HFD3-VI/12	12	9	1.2	720x (1±10%)	200	24
HFD3-VI/24	24	18	2.4	2880 x (1±10%)	200	48

1 coil latching

Coil Code	Nominal Voltage VDC ¹⁾	Initial Pick-up Voltage VDC ¹⁾ max.	Initial Drop-out Voltage VDC ¹⁾ min.	Coil Resistance Ω	Nominal Power mW approx.	Max. Voltage VDC ⁴⁾
HFD3-VI/1.5-L1	1.5	1.13	1.13	16.1 x (1±10%)	140	3.0
HFD3-VI/2.4-L1	2.4	1.8	1.8	41 x (1±10%)	140	4.8
HFD3-VI/3-L1	3	2.25	2.25	64.3 x (1±10%)	140	6.0
HFD3-VI/4.5-L1	4.5	3.38	3.38	145 x (1±10%)	140	9.0
HFD3-VI/5-L1	5	3.75	3.75	178 x (1±10%)	140	10
HFD3-VI/6-L1	6	4.5	4.5	257 x (1±10%)	140	12
HFD3-VI/9-L1	9	6.75	6.75	579 x (1±10%)	140	18
HFD3-VI/12-L1	12	9	9	1028x (1±10%)	140	24
HFD3-VI/24-L1	24	18	18	4114 x (1±10%)	140	48

With 907 suffix

Single side stable

Coil Code	Nominal Voltage VDC ¹⁾	Initial Pick-up Voltage VDC ¹⁾ max.	Initial Drop-out Voltage VDC min.	Coil Resistance Ω	Nominal Power mW approx.	Max. Voltage VDC ⁴⁾
HFD3-VI/1.5	1.5	1.13	0.15	8 x (1±10%)	280	1.95
HFD3-VI/2.4	2.4	1.8	0.24	20.6 x (1±10%)	280	3.12
HFD3-VI/3	3	2.25	0.3	32.1x (1±10%)	280	3.9
HFD3-VI/4.5	4.5	3.38	0.45	72.3 x (1±10%)	280	5.85
HFD3-VI/5	5	3.75	0.5	89.3 x (1±10%)	280	6.5
HFD3-VI/6	6	4.5	0.6	128.6 x (1±10%)	280	7.8
HFD3-VI/9	9	6.75	0.9	289.3x (1±10%)	280	11.7
HFD3-VI/12	12	9	1.2	514.3x (1±10%)	280	15.6
HFD3-VI/24	24	18	2.4	1920x (1±10%)	300	31.2

COIL DATA

at 23°C

With 907 suffix
1 coil latching

Coil Code	Nominal Voltage VDC ¹⁾	Initial Set Voltage VDC ¹⁾ max.	Initial Reset Voltage VDC ¹⁾ min.	Coil Resistance Ω	Nominal Power mW approx.	Max. Voltage VDC ⁴⁾
HFD3-VI/1.5-L1	1.5	1.13	1.13	11.2 x (1±10%)	200	3.0
HFD3-VI/2.4-L1	2.4	1.8	1.8	28.8 x (1±10%)	200	4.8
HFD3-VI/3-L1	3	2.25	2.25	45 x (1±10%)	200	6.0
HFD3-VI/4.5-L1	4.5	3.38	3.38	101 x (1±10%)	200	9.0
HFD3-VI/5-L1	5	3.75	3.75	125 x (1±10%)	200	10
HFD3-VI/6-L1	6	4.5	4.5	180 x (1±10%)	200	12
HFD3-VI/9-L1	9	6.75	6.75	405 x (1±10%)	200	18
HFD3-VI/12-L1	12	9	9	720x (1±10%)	200	24
HFD3-VI/24-L1	24	18	18	2880 x (1±10%)	200	48

Notes:1) The data shown above are initial values.

2) To supply rated step voltage to coil is the foundation of relay proper operation.

Please make sure the applied voltage to the coil reach at rated values.

Please refer to the typical diagram right for single side stable relay.

The "V_{coil}" is the rated voltage:

3) In case 5V of transistor drive circuit, it is recommended to use 4.5V type relay, and 3V to use 2.4V type relay.

4) For monostable relays, if you need to drop down voltage and hold mode after reliably operating, make sure that the effective value of holding voltage is not less than 60% of the rated voltage.

5) Maximum voltage refers to the maximum voltage which relay coil could endure in a short period of time.

6) When user's requirements can't be found in the above table, special order allowed.

7) During the relay pick-up or drop-out processes, there are stages of contact pressure change, contact vibration and unstable contact etc. When the voltage applied to coil is gradually changed, it will lengthen the unstable stage and affect relay endurance.

To reduce this influence, please apply step voltage (switching circuit) to relay coil.

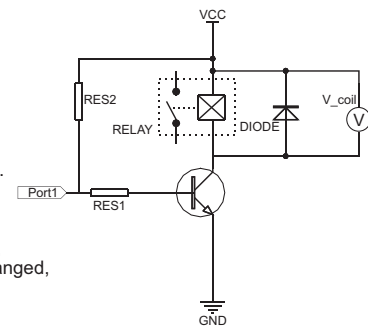

ORDERING INFORMATION

Type	HFD3-VI / 24 -2H -L1 3 S R (XXX)						
Coil voltage	1.5, 2.4, 3, 4.5, 5, 6, 9, 12, 24VDC						
Sort	2H: 2 Form A		2Z: 2 Form C				
Sort	L1: 1 coil latching		Nil: Single side stable				
Contact material	3: AgNi+Gold plated						
Terminal type	S: Standard SMT		S1: Short terminal SMT		Nil: DIP		
Packing style	R: Tape and reel packing (Only for SMT type) ¹⁾ Nil: Tube packing(Only for DIP type) ²⁾						
Special code ³⁾	XXX: Customer special requirement		Nil: Standard				
	For instance: Product with 907 suffix, meet ITU-T K.21 requirement on surge voltage. Product with 888 suffix is for application at 105°C. Product with 897 suffix is with pin distance at 4.58mm.						

Notes: 1) R type (tape and reel) packing is moisture-proof which meets requirement of MSL-3. Please choose R type packing for SMT products. For R type, the letter "R" will only be printed on packing tag but not on relay cover. Tube packing is normally not available for SMT products unless specially requested by customer. But please note that tube packing is not moisture-proof so please bake the products before use according to description of Notice 11 herewith. In addition, tube packaging will be adopted when the ordering quantity of R type is equal to or less than 100 pieces unless otherwise specified.

2) The standard tube length is 624mm.

3) The customer special requirement express as special code after evaluating by Hongfa. The suffix 907, 888 & 897 are for special versions. The ordering PN should be HFD3-VI/12-2Z-3(907) for instance.

4) For products that should meet the explosion-proof requirements of "IEC 60079 series", please note [Ex] after the specification while placing orders. Not all products have explosion-proof certification, so please contact us if necessary, in order to select the suitable products.

OUTLINE DIMENSIONS, WIRING DIAGRAM AND PC BOARD LAYOUT

Unit: mm

Outline Dimensions

PCB Layout (Bottom view)

Type 2H:

DIP type

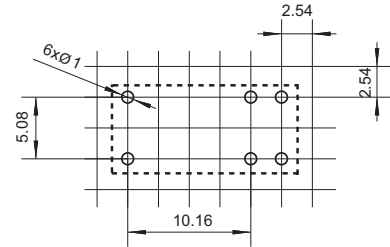
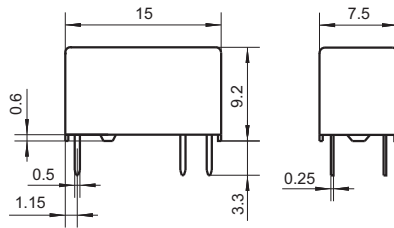

Standard SMT type

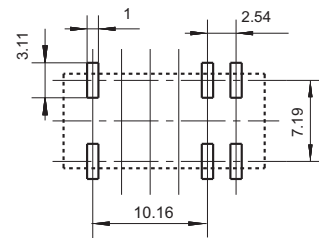
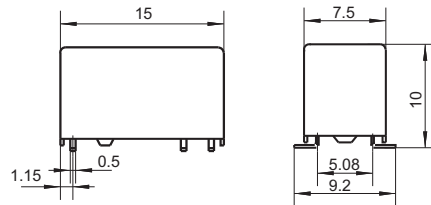

Short terminal SMT type

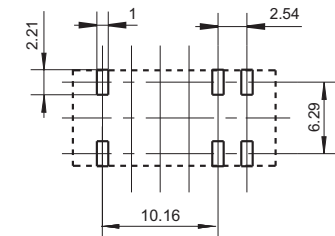
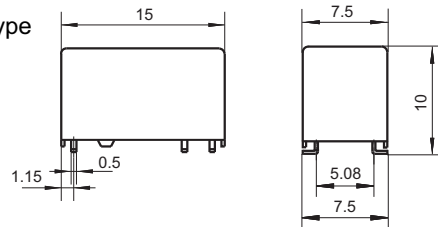

Single side stable

1 coil latching

Wiring Diagram
(Bottom view)

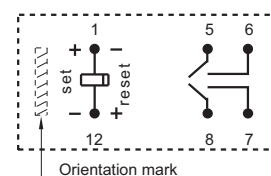
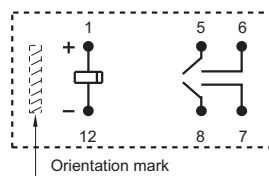

No energized condition

Reset condition

OUTLINE DIMENSIONS, WIRING DIAGRAM AND PC BOARD LAYOUT

Unit: mm

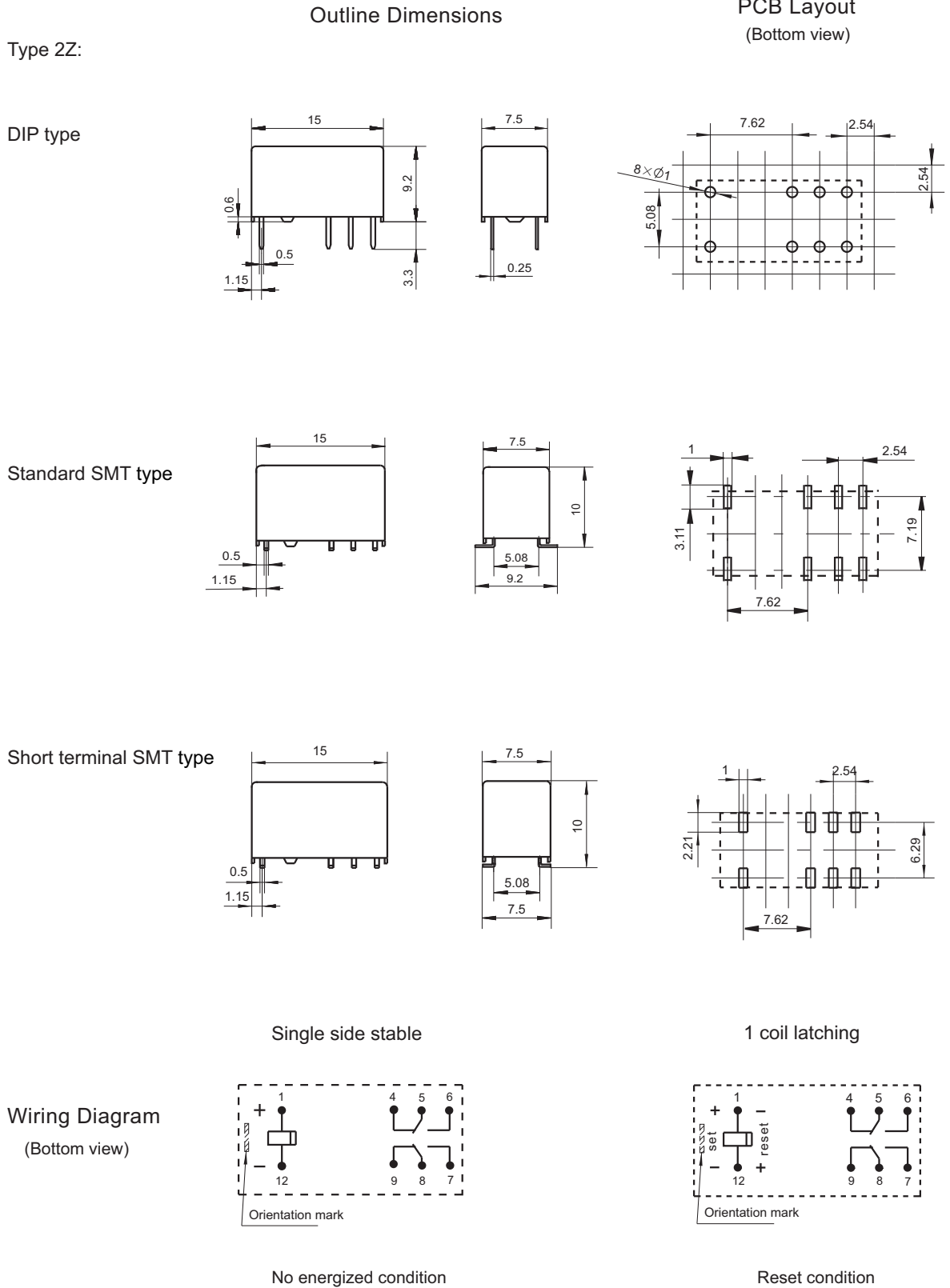

OUTLINE DIMENSIONS, WIRING DIAGRAM AND PC BOARD LAYOUT

Unit: mm

Outline Dimensions

PCB Layout (Bottom view)

With 897 suffix

Type 2H:

DIP type

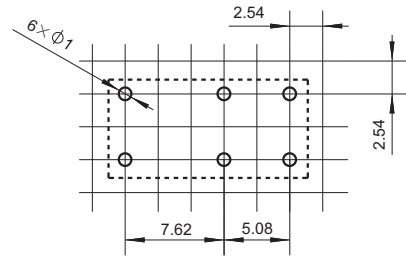
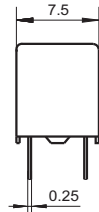
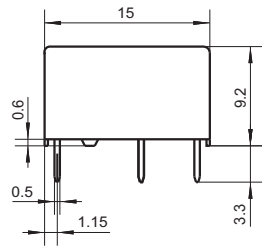

Standard SMT type

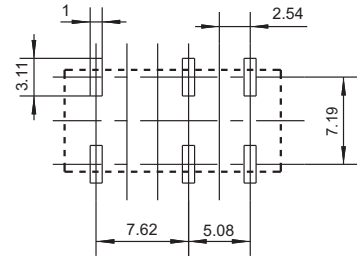
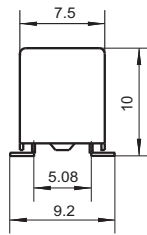
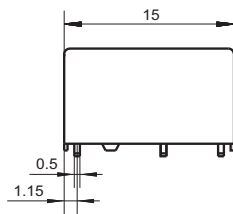

Short terminal SMT type

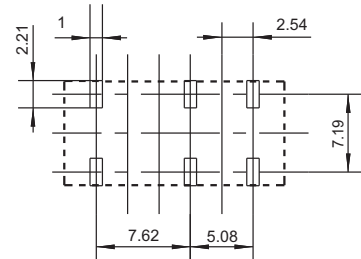
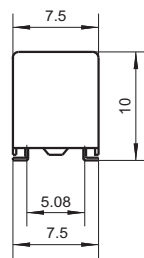
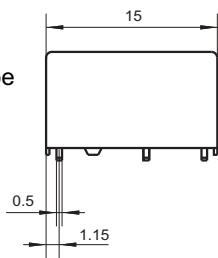

Wiring Diagram
(Bottom view)

Single side stable

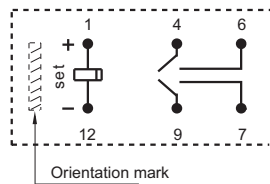

No energized condition

1 coil latching

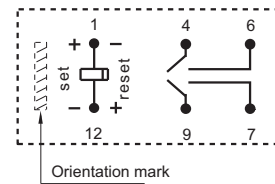

Reset condition

OUTLINE DIMENSIONS, WIRING DIAGRAM AND PC BOARD LAYOUT

Unit: mm

Pin Layout

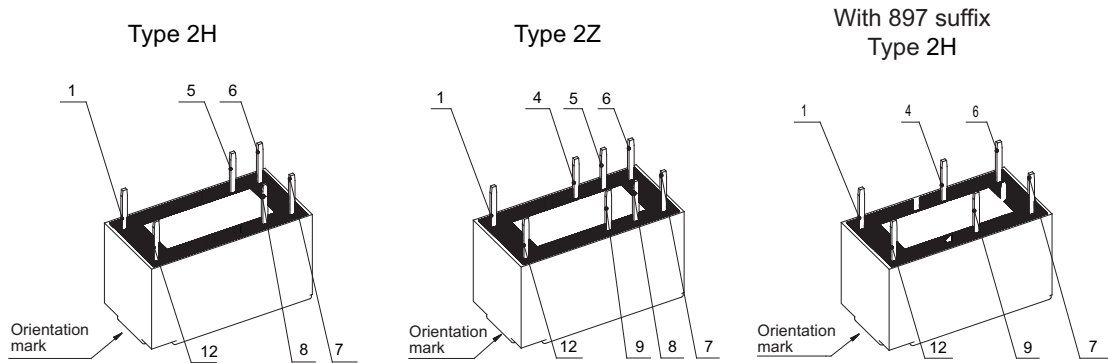

Remark: 1) The size of the pin of the external map of the product is the size before the tin (after the tin is touched), and the size of the installation hole is the design size of the recommended PCB plate hole. The design size of the specific PCB plate hole can be mapped and adjusted according to the product's physical object;

2) In case of no tolerance shown in outline dimension: outline dimension ≤ 1 mm, tolerance should be ± 0.2 mm; outline dimension > 1 mm and ≤ 5 mm, tolerance should be ± 0.3 mm; outline dimension > 5 mm, tolerance should be ± 0.4 mm. e without indicating for PCB layout is always ± 0.1 mm.

TAPE PACKING

Unit: mm

Direction of Relay Insertion

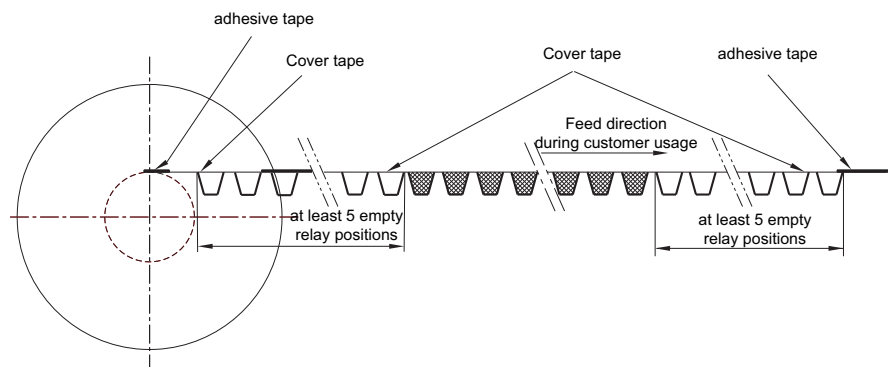
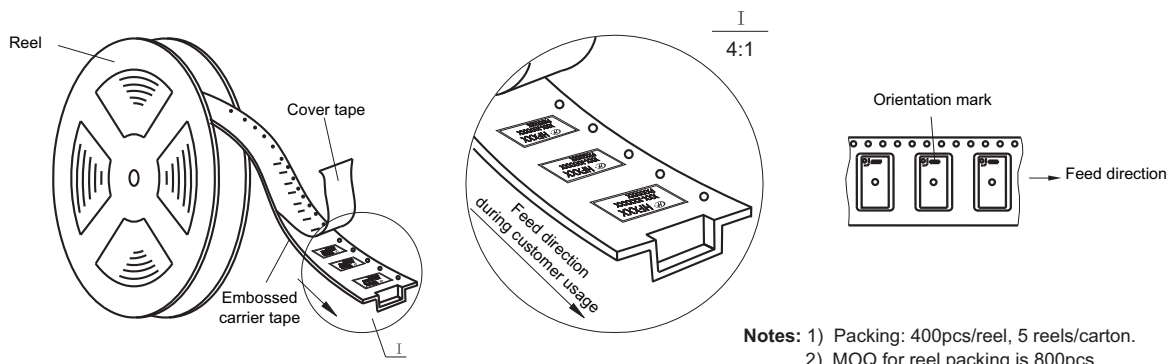

Reel Dimensions

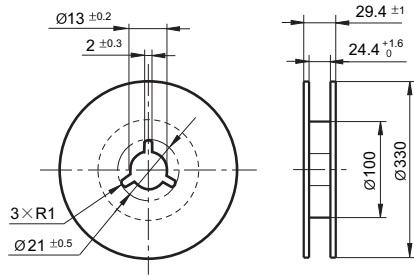

Tape Dimensions (S type: Standard SMT)

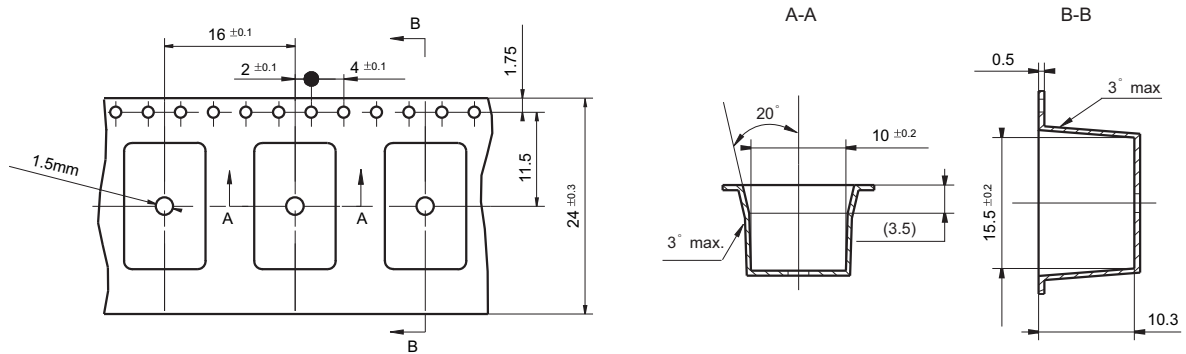

Tape Dimensions (S1 type: Short terminal SMT)

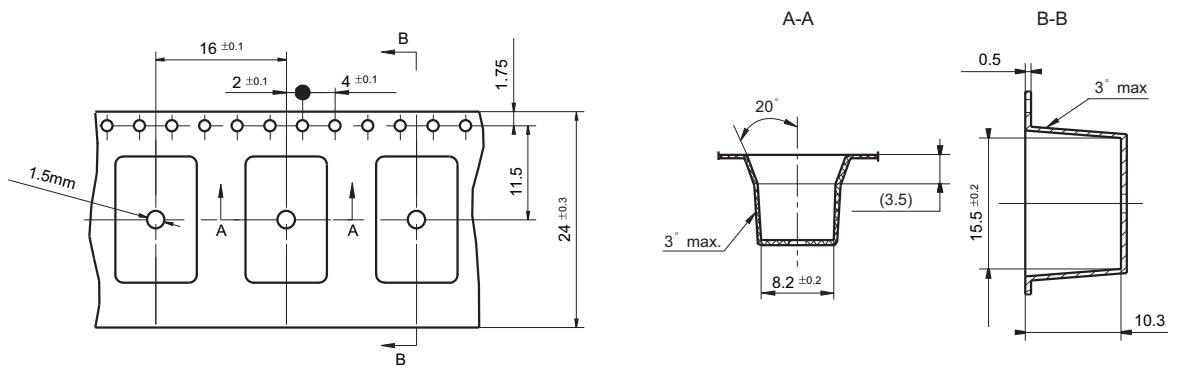

CHARACTERISTIC CURVES

MAXIMUM SWITCHING POWER

Two sets of open/closed contacts in series

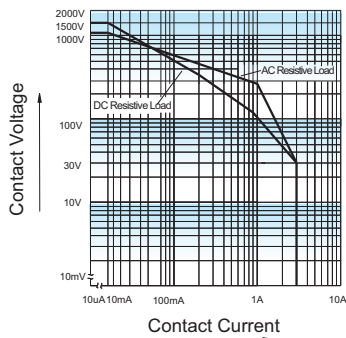

Singl contact

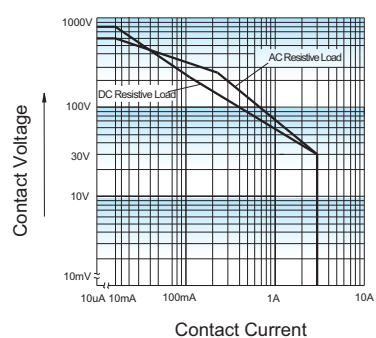

CHARACTERISTIC CURVES

MAXIMUM SWITCHING POWER

Two sets of open/closed contacts in series

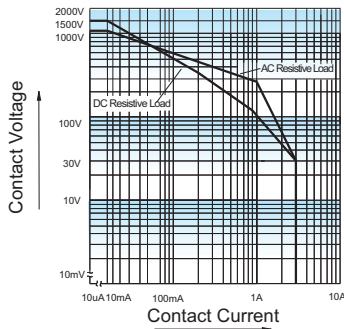

Singl contact

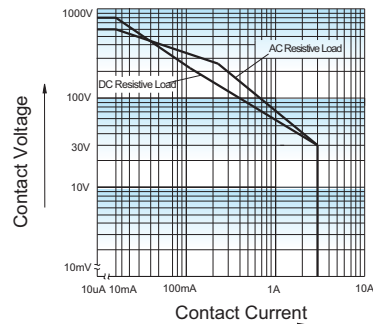

ENDURANCE CURVE

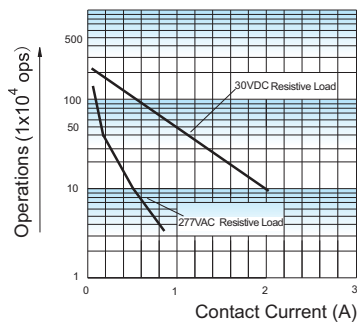

Test conditions:
1 form A or 1 form B
Resistive load, at 85°C, 1s on 9s off.

Temperature/Time profile of Reflow Soldering see below:

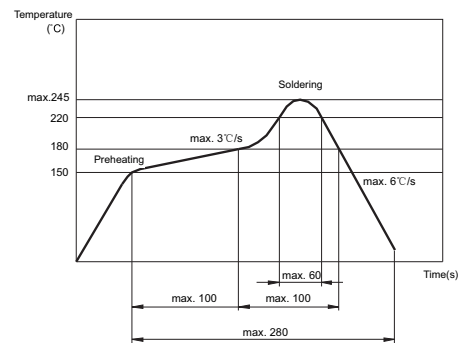

Notice

- 1) This relay is highly sensitive polarized relay, if correct polarity is not applied to the coil terminals, the relay does not operate properly.
- 2) To avoid using relays under strong magnetic field which will change the parameters of relays such as pick-up voltage and drop-out voltage.
- 3) Relay is on the "reset" status when being released from stock, with the consideration of shock risen from transit and relay mounting, it should be changed to the "set" status when application(connecting to the power supply). Please reset the relay to "set" or "reset" status on request.
- 4) Energizing coil with rated voltage is basic for normal operation of a relay, please make sure the energized voltage to relay coil have reached the rated voltage. Regarding latching relay, in order to maintain the "set" or "reset" status, impulse width of the rated voltage applied to coil should be more than 5 times of "set" or "reset" time.
- 5) For a monosteady state relay, after the relay is reliably operated, if it needs to be kept under pressure, make sure that the effective value of the voltage is not less than 60 % of the rated voltage;
- 6) The relay may be damaged because of falling or when shocking conditions exceed the requirement.
- 7) For SMT products, validation with real application should be done before your series production, if the reflow-soldering temperature curve is out of our recommendation. Generally, two-time reflow-soldering is not recommended for the relay. However, if two-time reflow-soldering is required, a 60-min. interval should be guaranteed and a validation should be done before production.
- 8) Please use wave soldering or manual soldering for straight-in relay. If you need reflow welding, please confirm the feasibility with us.
- 9) Contact is recommended for suitable condition and specifications if water cleaning or surface process is involved in assembling relays on PCB.
- 10) Regarding the plastic sealed relay, we should leave it cooling naturally untill below 40°C after welding, then clean it and deal with coating, remarkably the temperature of solvents should also be controlled below 40°C. Please avoid cleaning the relay by ultrasonic, avoid using the solvents like gasoline, Freon, and so on, which would affect the configuration of relay or influence the environment.
- 11) Relays packaged in moisture barrier bags meet MSL-3 requirements. The relays should be stored at ambient conditions of $\leq 30^{\circ}\text{C}$ and $\leq 60\%$ RH after they are removed from their packaging, and should be used within 168 hours. If the relays cannot be used within 168 hours, please repack them or store them in a drying oven at $25^{\circ}\text{C} \pm 5^{\circ}\text{C}$, $\leq 10\%$ RH. Otherwise, relays may be subjected to a soldering test to check their performance, or they may be used after keeping them in an oven for 72 hours at with $50^{\circ}\text{C} \pm 5^{\circ}\text{C}$, $\leq 30\%$ RH.
- 12) When applied with continuous current, the heat from relay coil will age its isolation. Thus, please do not ground connected the coil to reduce electrical erosion if possible. And please provide protection circuit to avoid broken wire and losses.
- 13) Please make sure that there are no silicon-based substances (such as silicon rubber, silicone oil, silicon-based coating agents, silicon fillers, etc.) around the relay, because it will generate silicon-containing volatile gas, which may cause poor contact in case of silicon-containing volatile gas sticking on contact.
- 14) About preferable condition of operation, storage and transportation, please refer to "Explanation to terminology and guidetines of relay".
- 15) During the relay pick-up or drop-out processes, there are stages of contact pressure change, contact vibration and unstable contact etc.
When the voltage applied to coil is gradually changed, it will lengthen the unstable stage and affect relay endurance. To reduce this influence, please apply step voltage (switching circuit) to relay coil.

Disclaimer

The specification is for reference only. See to "Terminology and Guidelines" for more information. Specifications subject to change without notice. We could not evaluate all the performance and all the parameters for every possible application. Thus the user should be in a right position to choose the suitable product for their own application. If there is any query, please contact Hongfa for the technical service. However, it is the user's responsibility to determine which product should be used only.

© Xiamen Hongfa Electroacoustic Co., Ltd. All rights of Hongfa are reserved.