

ProLight PDSJ-25FQL-D2748
25W Dual Color COB
Light-Engine LEDs
Technical Datasheet
Version: 1.2

ProLight Opto ® ProEngine Series

Features

- High flux density of lighting source
- Good color uniformity
- RoHS compliant
- More energy efficient than incandescent and most halogen lamps
- No UV
- Long lifetime
- 5 year warranty

Main Applications

- Spot lighting
- Down lighting

Introduction

- The 25W multi-chip power ProEngine Series is designed with 2 channels, providing color temperature changes from 4800K to 2700K remaining similar flux.
- The superficial illuminating nature makes it the preference in applications including downlighting, spot lighting and accent lighting at restaurant, hotel, studio, historical spot and home.

Mechanical Dimensions

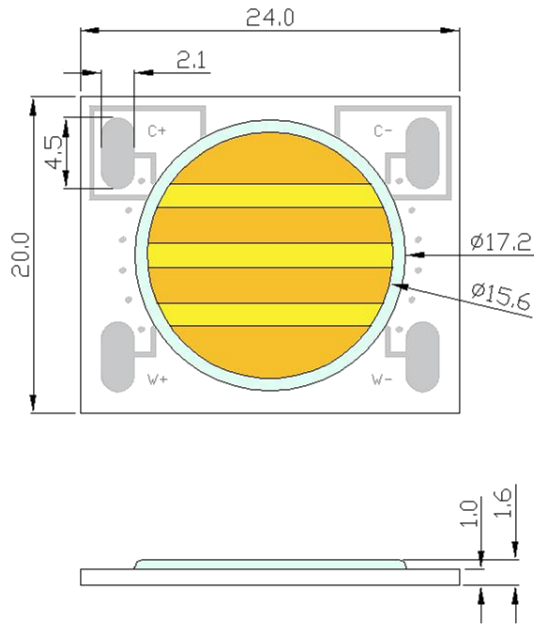

Circuit Diagram

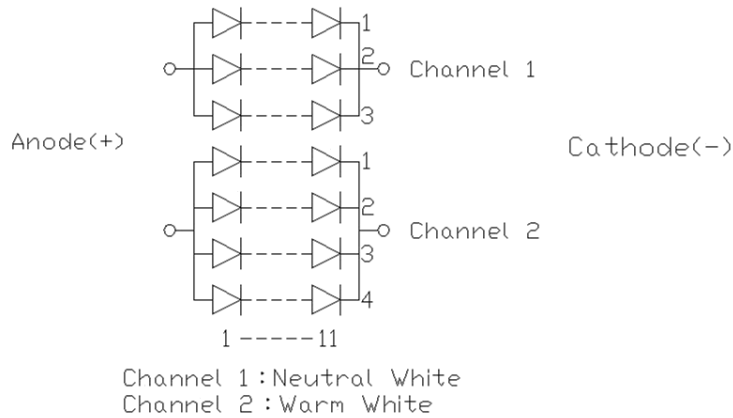

Notes:

1. Solder pads are labeled "+" and "-" to denote positive and negative, respectively.
2. Drawing not to scale.
3. All dimensions are in millimeters.
4. Unless otherwise indicated, tolerances are ± 0.30 mm.
5. **Please do not use a force of over 0.3kgf impact or pressure on the lens of the LED, otherwise it will cause a catastrophic failure.**

*The appearance and specifications of the product may be modified for improvement without notice.

Flux Characteristics at 450mA, $T_c = 25^\circ\text{C}$

Radiation Pattern	Color	Part Number COB	Luminous Flux Φ_v (lm)		CRI Min.
			Min.	Typ.	
Lambertian	Channel 1	PDSJ-25FQL-D2748	1630	1800	90
	Channel 2		1440	1650	

- ProLight maintains a tolerance of $\pm 7\%$ on flux and power measurements.
- ProLight maintains a tolerance of ± 2 on CRI measurements.
- Please do not drive at rated current more than 1 second without proper heat sink.

Electrical Characteristics at 450mA, $T_c = 25^\circ\text{C}$

Color	Forward Voltage V_F (V)			Thermal Resistance Junction to Board ($^\circ\text{C/W}$)
	Min.	Typ.	Max.	
Channel 1	35.0	37.0	39.0	1.1
Channel 2	35.0	36.0	38.0	

- ProLight maintains a tolerance of $\pm 1\text{V}$ for Voltage measurements.

Optical Characteristics at 450mA, $T_c = 25^\circ\text{C}$

Color	Bin Code	Color Temperature CCT			Total included Angle (degrees) $\theta_{0.90v}$	Viewing Angle (degrees) $2\theta_{1/2}$
		Min.	Typ.	Max.		
Channel 1	U0	4530 K	4800 K	4960 K	160	120
Channel 2	M1	2690 K	2700 K	2820 K	160	120

- ProLight maintains a tolerance of $\pm 5\%$ for CCT measurements.

Electro-Optical Characteristics, $T_c = 25^\circ\text{C}$

I_F (mA)	V_F (V)	Power (W)	Channel 1	
			Flux (lm)	lm/W
100	33.64	3.36	464.9	138.2
200	35.44	7.09	894.7	126.2
350	37.45	13.11	1472.4	112.0
450*	38.72	17.42	1800.0	103.3
650	40.76	26.49	2391.5	90.3

I_F (mA)	V_F (V)	Power (W)	Channel 2	
			Flux (lm)	lm/W
100	32.80	3.28	395.2	120.5
200	34.15	6.83	768.7	112.6
350	35.75	12.51	1283.8	102.6
450*	36.65	16.49	1650.0	100.1
650	38.20	24.83	2162.4	87.1

- The mark "*" indicated product is tested and binned at the specified drive current.
- All values are reference only.

Absolute Maximum Ratings

Parameter	Channel 1/Channel 2
Max DC Forward Current (mA)	650
Peak Pulsed Forward Current (mA)	800 (less than 1/10 duty cycle@1KHz)
ESD Sensitivity (HBM per MIL-STD-883E Method 3015.7)	$\pm 2000\text{V}$
LED Junction Temperature	120°C
Operating Board Temperature at Maximum DC Forward Current	$-40^\circ\text{C} - 90^\circ\text{C}$
Storage Temperature	$-40^\circ\text{C} - 120^\circ\text{C}$
Reverse Voltage	Not designed to be driven in reverse bias

Color Bin

Channel 1 and Channel 2 Binning Structure Graphical Representation

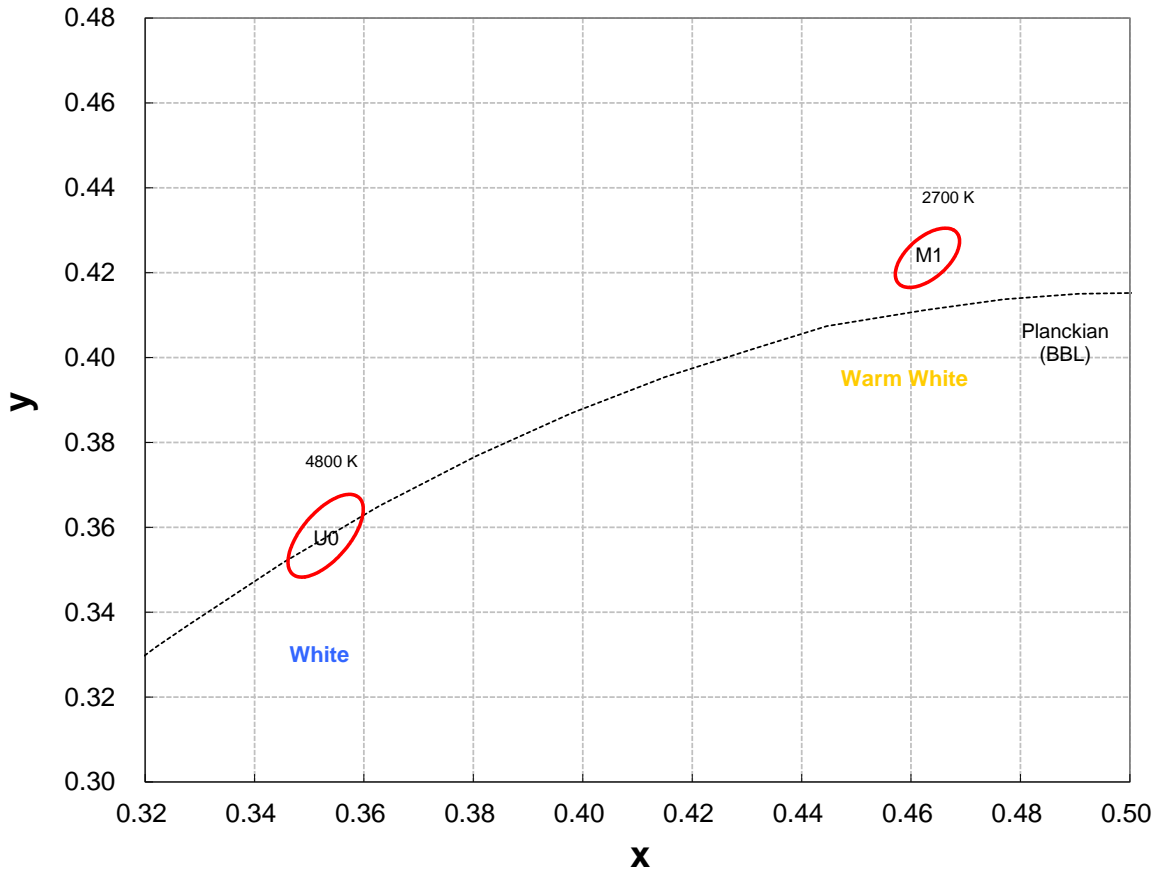

Channel 1 and Channel 2 Bin Structure

Bin Code	Center	Oval parameter	Typ. CCT (K)	Bin Code	Center	Oval parameter	Typ. CCT (K)
M1	x	a	2700	U0	x	a	4800
	y	b			y	b	
		e°				e°	

- Color range stay within MacAdam “3-step” and “4-step” ellipse from the chromaticity center.
- The chromaticity center refers to ANSI C78.377.
- Tolerance on each color bin (x , y) is ± 0.005

Color Spectrum, $T_c = 25^\circ\text{C}$

1. Dual Color : 2700K~4800K

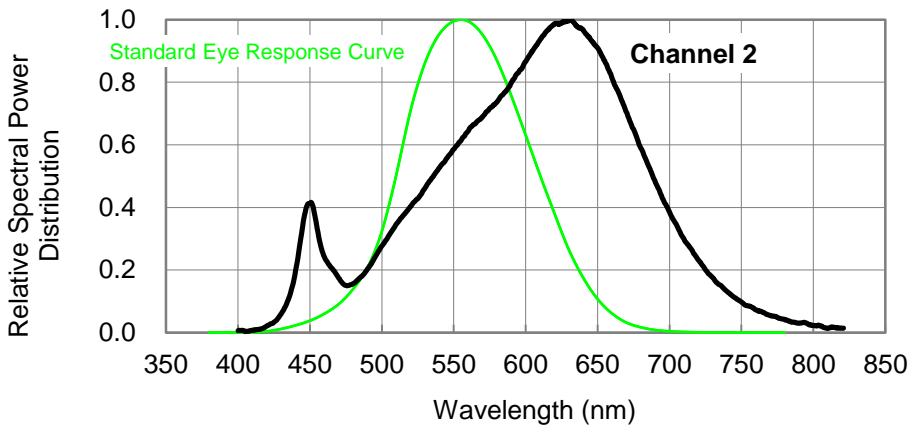
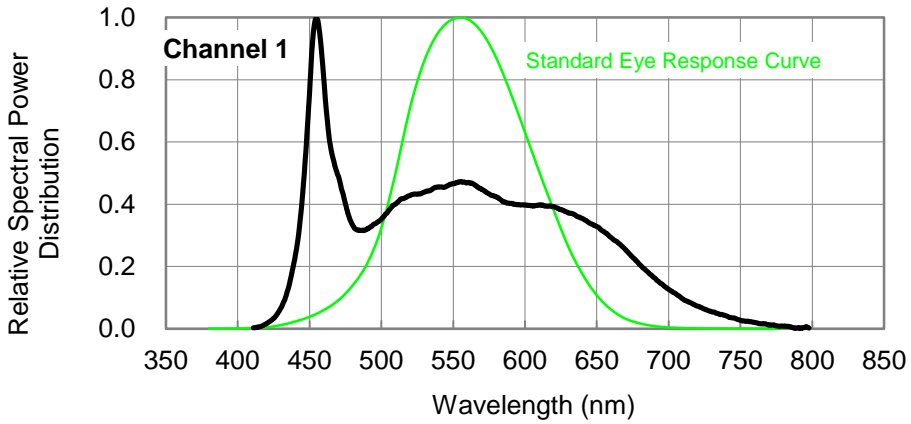

Forward Current Relative Characteristics

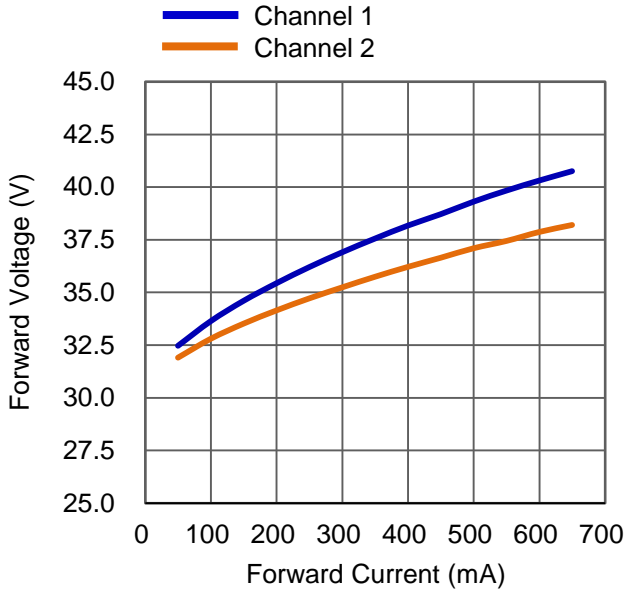

Fig 1. Forward Current vs. Forward Voltage at $T_c=25^\circ\text{C}$.

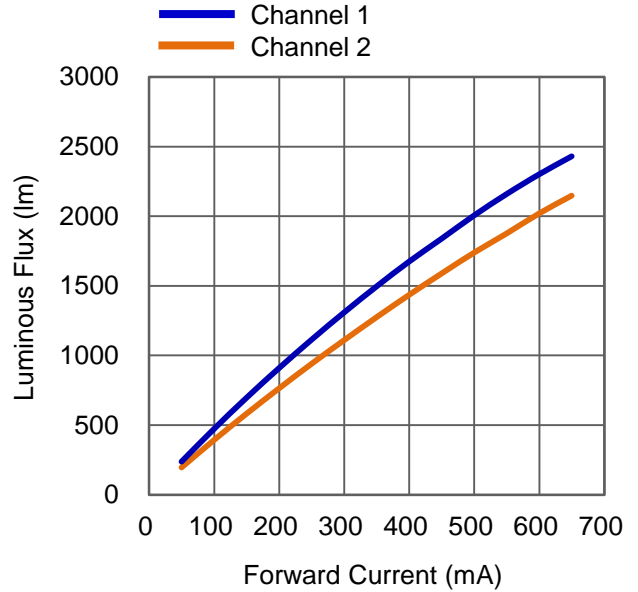
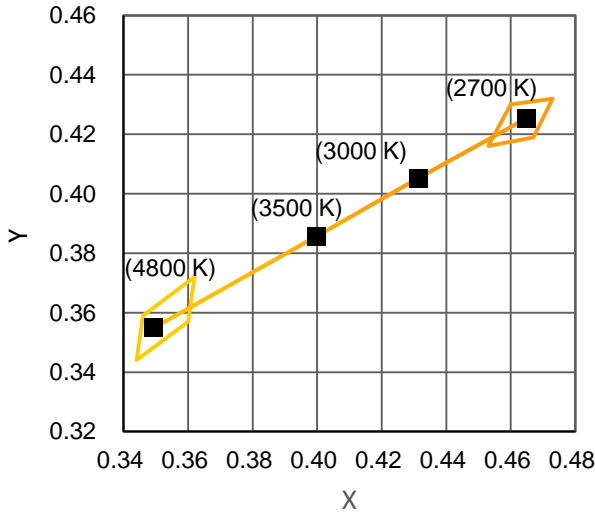

Fig 2. Forward Current vs. Relative Luminous Flux at $T_c=25^\circ\text{C}$.



2700 K : Channel 1 0mA Channel 2 450mA
 3000 K : Channel 1 140mA Channel 2 310mA
 3500 K : Channel 1 250mA Channel 2 210mA
 4800 K : Channel 1 450mA Channel 2 0mA

Fig 3. Chromaticity Coordinate Profile at $T_c=25^\circ\text{C}$.

Case Temperature Relative Characteristics

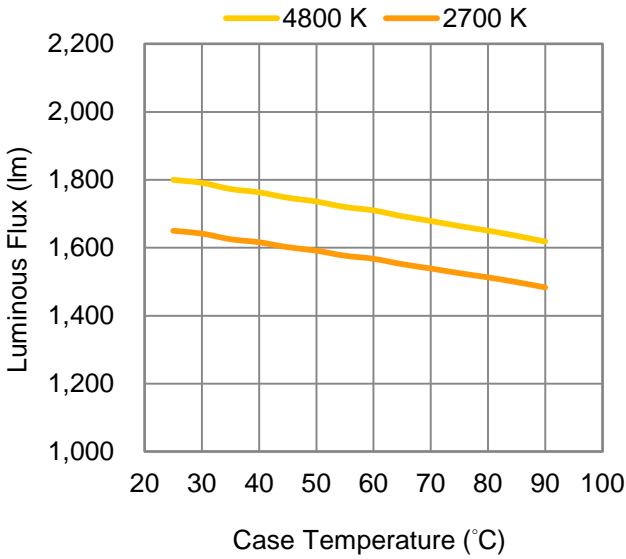

Fig 4. Case Temperature vs. Luminous Flux at 450 mA.

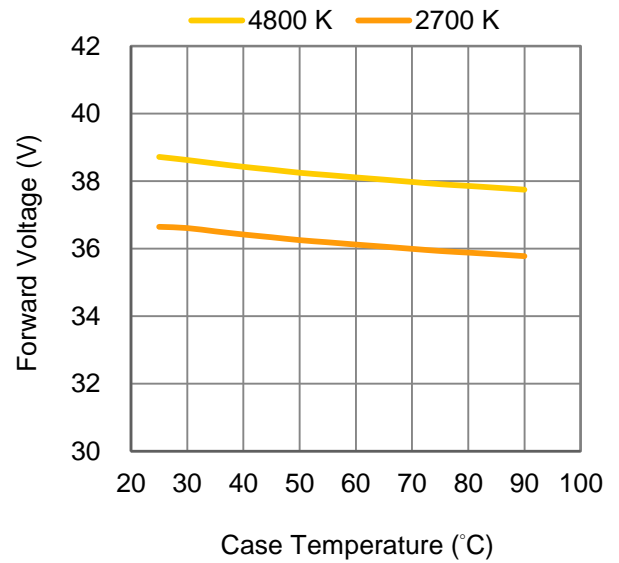

Fig 5. Case Temperature vs. Forward Voltage at 450 mA.

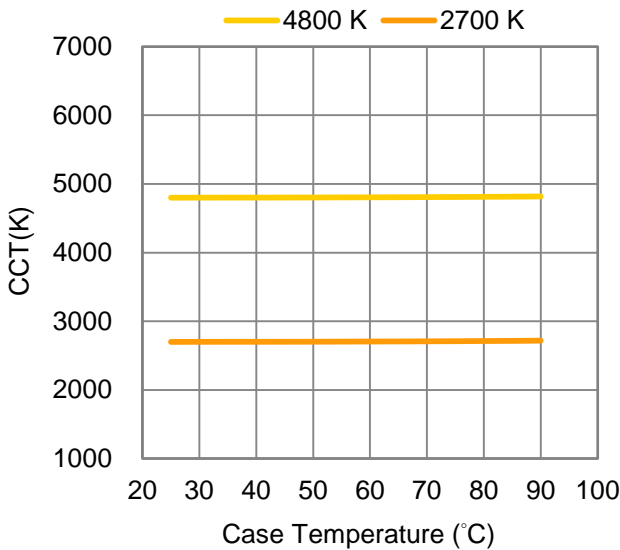
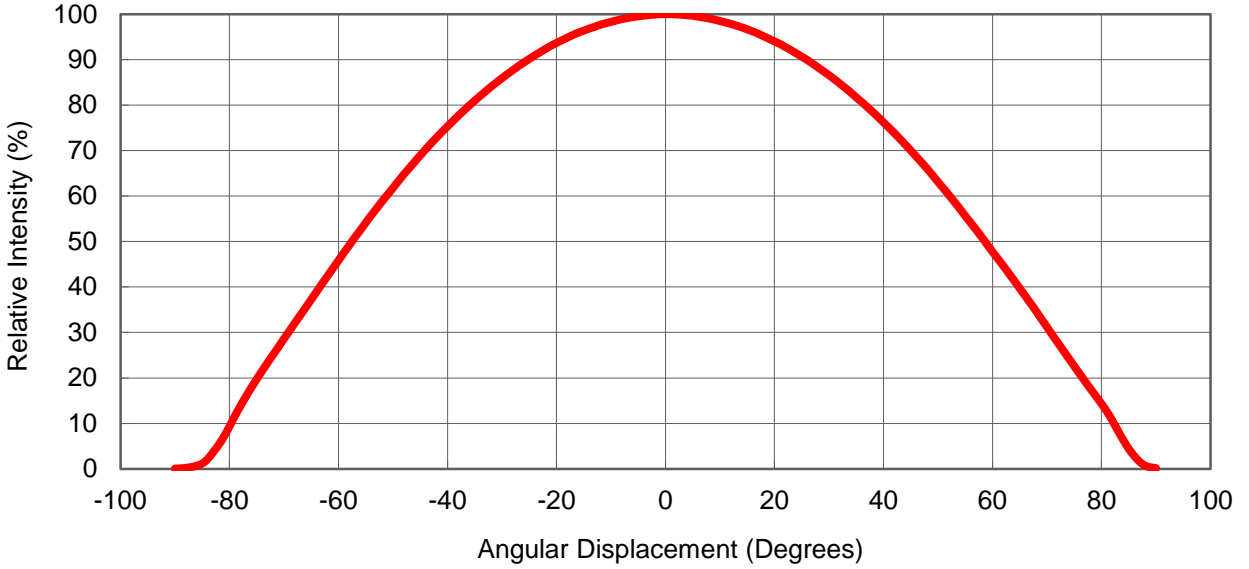

Fig 6. Case Temperature vs. Chromaticity Coordinate Δx at 450 mA.

Typical Representative Spatial Radiation Pattern

Lambertian Radiation Pattern



Polar Radiation Pattern

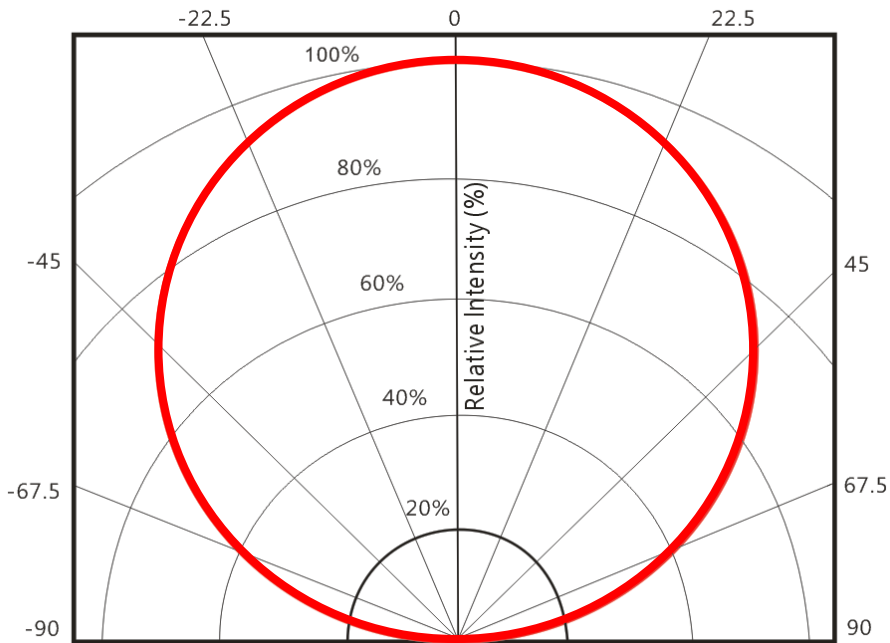

Packing Specifications

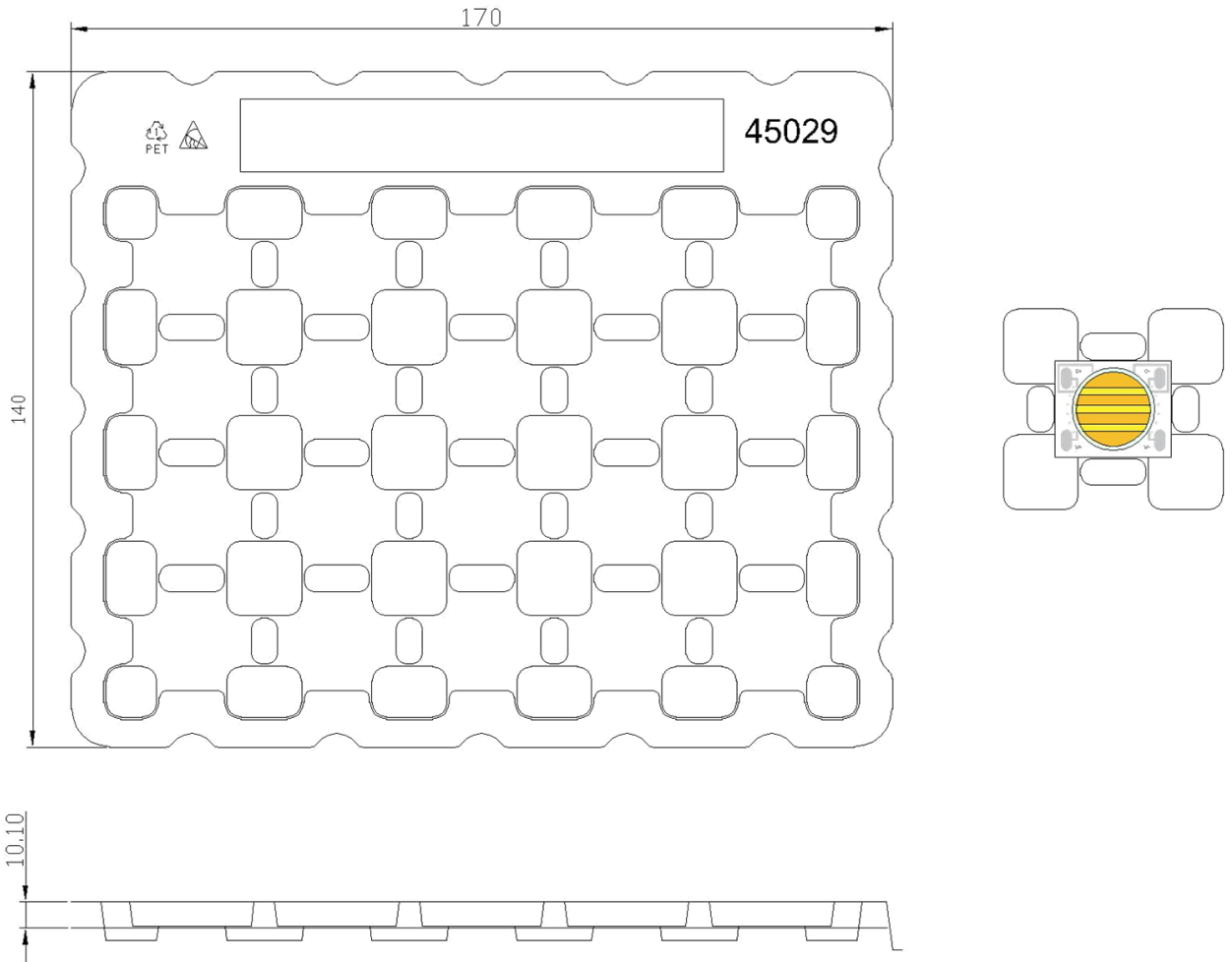

Product 20 pcs/tray

Notes:

1. Drawing not to scale.
2. All dimensions are in millimeters.
3. Unless otherwise indicated, tolerances are $\pm 0.20\text{mm}$.

Recommended Soldering Condition

- Please use lead free and “no clean ” solders.
- Soldering shall be implemented using a soldering tip at a temperature lower than 350 °C, and shall be finished within 3.5 seconds for each pad.
- During the soldering process, put the LEDs on materials whose conductivity is poor enough not to radiate heat of soldering.
- Properly solder tin wires before soldering them to LEDs.
- Avoid touching the silicone lens with the soldering iron.
- Please prevent flux from touching to the silicone lens.
- Please solder evenly on each pad.
- Contacts number of a soldering tip should be within twice for each pad.
- Next process of soldering should be carried out after the LEDs have return to ambient temperature.

*ProLight cannot guarantee if usage exceeds these recommended conditions.

Please use it after sufficient verification is carried out on your own risk if absolutely necessary.

Precaution for Use

- The modules light output are intense enough to cause injury to human eyes if viewed directly. Precautions must be taken to avoid looking directly at the modules with unprotected eyes.
- The modules are sensitive to electrostatic discharge. Appropriate ESD protection measures must be taken when working with the modules. Non-compliance with ESD protection measures may lead to damage or destruction of the product.
- Chemical solvents or cleaning agents must not be used to clean the modules. Mechanical stress on the Emitters must be avoided. It is best to use a soft brush, damp cloth or low-pressure compressed air.
- The products should be stored away from direct light in dry location.
- The appearance, specifications and flux bin of the product may be modified for improvement without notice. Please refer to the below website for the latest datasheets.
<http://www.prolightopto.com/>

Handling of Silicone Lens LEDs

Notes for handling of silicone lens LEDs

- Please do not use a force of over 0.3kgf impact or pressure on the silicone lens, otherwise it will cause a catastrophic failure.
- Avoid touching the silicone lens and the optical area of the COB Array especially by sharp tools such as Tweezers
- Avoid touching the silicone lens especially by sharp tools such as Tweezers.
- Avoid leaving fingerprints on the silicone lens.
- Please store the LEDs away from dusty areas or seal the product against dust.
- Please do not mold over the silicone lens with another resin. (epoxy, urethane, etc)