

High Performance Schottky Rectifier, 8 A

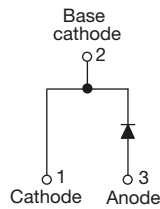

2L TO-220AC



FEATURES

- 175 °C T_J operation
- Low forward voltage drop
- High frequency operation
- High purity, high temperature epoxy encapsulation for enhanced mechanical strength and moisture resistance
- Guard ring for enhanced ruggedness and long term reliability
- Designed and qualified according to JEDEC®-JESD 47
- Material categorization: for definitions of compliance please see www.vishay.com/doc?99912

RoHS
 COMPLIANT
 HALOGEN
FREE

DESCRIPTION

The VS-8TQ... Schottky rectifier series has been optimized for low reverse leakage at high temperature. The proprietary barrier technology allows for reliable operation up to 175 °C junction temperature. Typical applications are in switching power supplies, converters, freewheeling diodes, and reverse battery protection.

PRIMARY CHARACTERISTICS	
$I_{F(AV)}$	8 A
V_R	60 V, 80 V, 100 V
V_F at I_F	0.58 V
I_{RM} max.	7 mA at 125 °C
T_J max.	175 °C
E_{AS}	7.5 mJ
Package	2L TO-220AC
Circuit configuration	Single

MAJOR RATINGS AND CHARACTERISTICS			
SYMBOL	CHARACTERISTICS	VALUES	UNITS
$I_{F(AV)}$	Rectangular waveform	8	A
V_{RRM}	Range	60 to 100	V
I_{FSM}	$t_p = 5 \mu s$ sine	850	A
V_F	8 A _{pk} , $T_J = 125 \text{ °C}$	0.58	V
T_J	Range	-55 to +175	°C

VOLTAGE RATINGS					
PARAMETER	SYMBOL	VS-8TQ060-M3	VS-8TQ080-M3	VS-8TQ100-M3	UNITS
Maximum DC reverse voltage	V_R	60	80	100	V
Maximum working peak reverse voltage	V_{RWM}				

ABSOLUTE MAXIMUM RATINGS					
PARAMETER	SYMBOL	TEST CONDITIONS		VALUES	UNITS
Maximum average forward current, see fig. 5	$I_{F(AV)}$	50 % duty cycle at $T_C = 157 \text{ °C}$, rectangular waveform		8	A
Maximum peak one cycle non-repetitive surge current, see fig. 7	I_{FSM}	5 μs sine or 3 μs rect. pulse	Following any rated load condition and with rated V_{RRM} applied	850	A
		10 ms sine or 6 ms rect. pulse		230	
Non-repetitive avalanche energy	E_{AS}	$T_J = 25 \text{ °C}$, $I_{AS} = 0.50 \text{ A}$, $L = 60 \text{ mH}$		7.50	mJ
Repetitive avalanche current	I_{AR}	Current decaying linearly to zero in 1 μs Frequency limited by T_J maximum $V_A = 1.5 \times V_R$ typical		0.50	A



ELECTRICAL SPECIFICATIONS					
PARAMETER	SYMBOL	TEST CONDITIONS		VALUES	UNITS
Maximum forward voltage drop See fig. 1	$V_{FM}^{(1)}$	8 A	$T_J = 25\text{ }^\circ\text{C}$	0.72	V
		16 A		0.88	
		8 A	$T_J = 125\text{ }^\circ\text{C}$	0.58	
		16 A		0.69	
Maximum reverse leakage current See fig. 2	$I_{RM}^{(1)}$	$T_J = 25\text{ }^\circ\text{C}$	$V_R = \text{rated } V_R$	0.55	mA
		$T_J = 125\text{ }^\circ\text{C}$		7	
Maximum junction capacitance	C_T	$V_R = 5 V_{DC}$ (test signal range 100 kHz to 1 MHz) $25\text{ }^\circ\text{C}$		500	pF
Typical series inductance	L_S	Measured lead to lead 5 mm from package body		8	nH
Maximum voltage rate of change	dV/dt	Rated V_R		10 000	V/ μ s

Note

(1) Pulse width < 300 μ s, duty cycle < 2 %

THERMAL - MECHANICAL SPECIFICATIONS					
PARAMETER	SYMBOL	TEST CONDITIONS		VALUES	UNITS
Maximum junction and storage temperature range	T_J, T_{Stg}			-55 to +175	$^\circ\text{C}$
Maximum thermal resistance, junction to case	R_{thJC}	DC operation See fig. 4		2.0	$^\circ\text{C/W}$
Typical thermal resistance, case to heatsink	R_{thCS}	Mounting surface, smooth, and greased		0.50	
Approximate weight				2	g
				0.07	oz.
Mounting torque	minimum maximum			6 (5)	kgf · cm (lbf · in)
				12 (10)	
Marking device		Case style 2L TO-220AC		8TQ060	
				8TQ080	
				8TQ100	

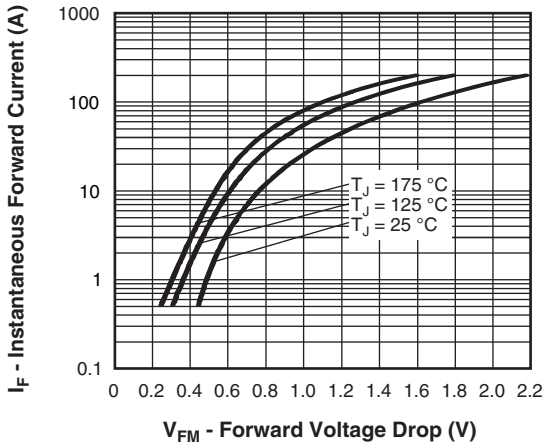

Fig. 1 - Maximum Forward Voltage Drop Characteristics

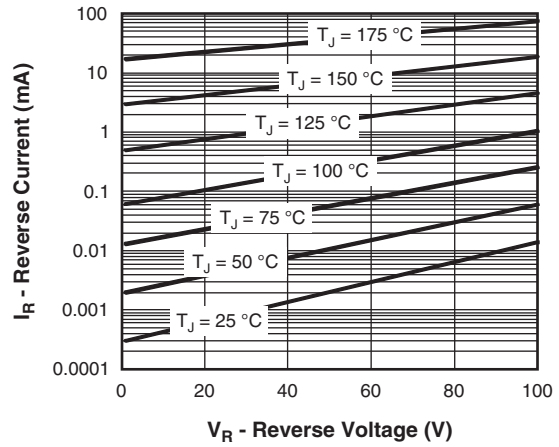

Fig. 2 - Typical Values of Reverse Current vs. Reverse Voltage

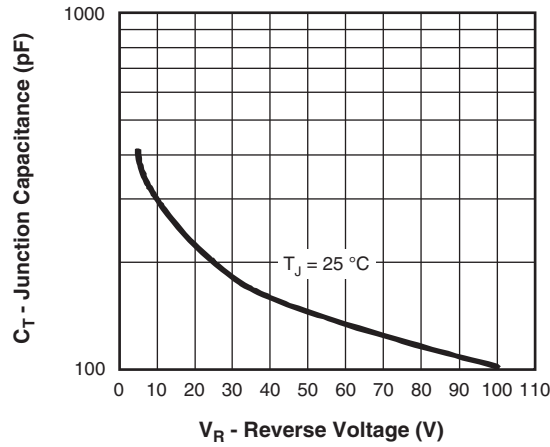

Fig. 3 - Typical Junction Capacitance vs. Reverse Voltage

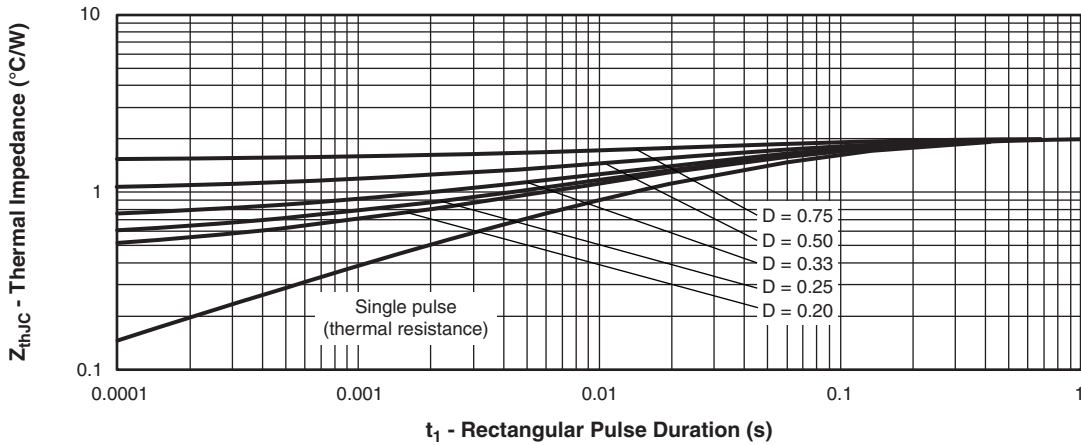

Fig. 4 - Maximum Thermal Impedance Z_{thJC} Characteristics

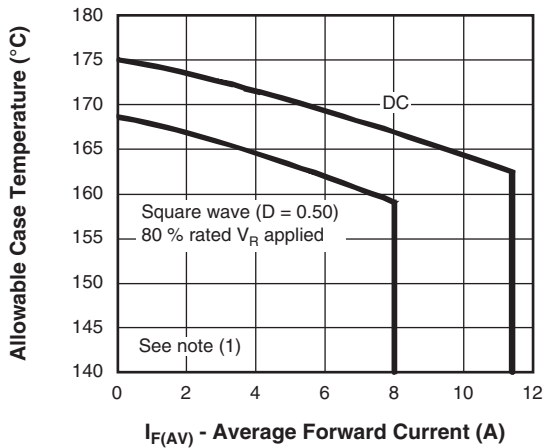

Fig. 5 - Maximum Allowable Case Temperature vs. Average Forward Current

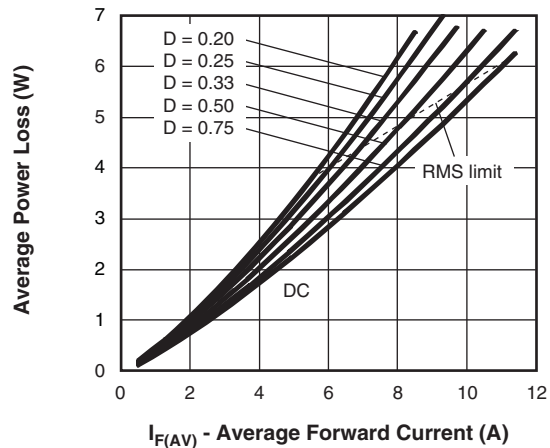

Fig. 6 - Forward Power Loss Characteristics

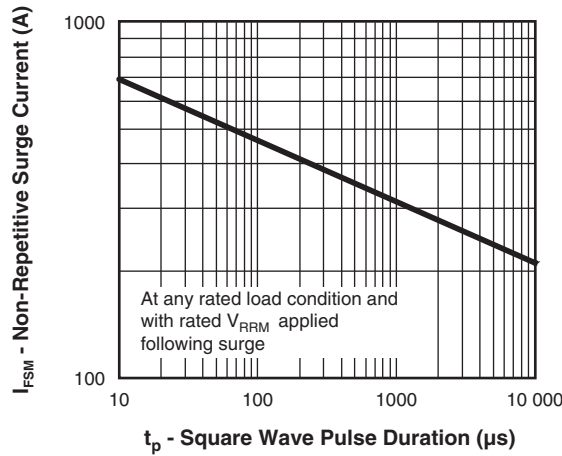

Fig. 7 - Maximum Non-Repetitive Surge Current

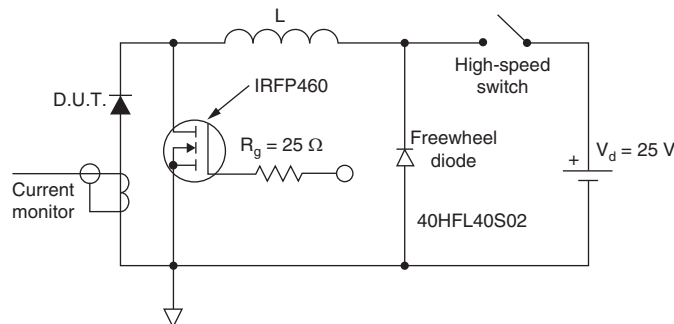

Fig. 8 - Unclamped Inductive Test Circuit

Note

- (1) Formula used: $T_C = T_J - (P_d + P_{d_{REV}}) \times R_{thJC}$
 P_d = forward power loss = $I_{F(AV)} \times V_{FM}$ at $(I_{F(AV)}/D)$ (see fig. 6);
 $P_{d_{REV}}$ = inverse power loss = $V_{R1} \times I_R (1 - D)$; I_R at $V_{R1} = 80\%$ rated V_R



ORDERING INFORMATION TABLE

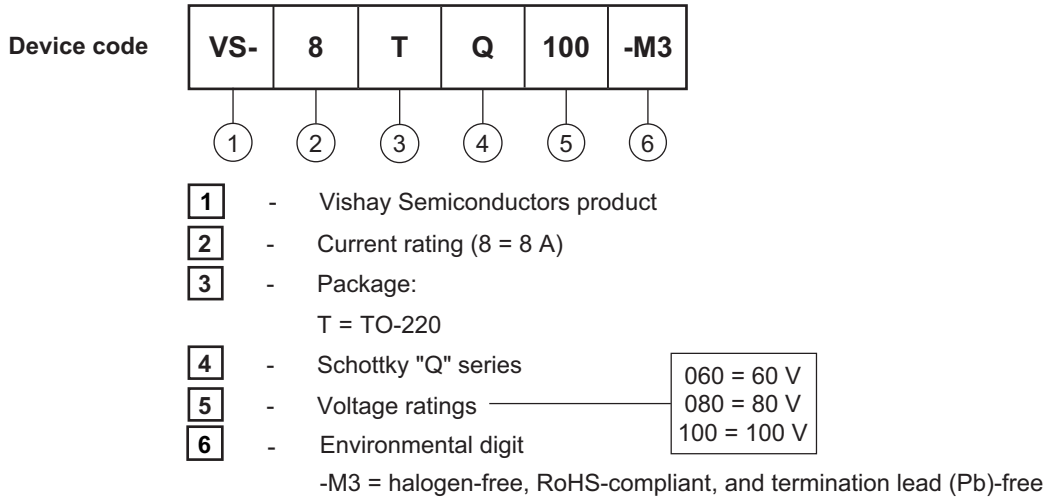

ORDERING INFORMATION (Example)			
PREFERRED P/N	QUANTITY PER T/R	MINIMUM ORDER QUANTITY	PACKAGING DESCRIPTION
VS-8TQ060-M3	50	1000	Antistatic plastic tube
VS-8TQ080-M3	50	1000	Antistatic plastic tube
VS-8TQ100-M3	50	1000	Antistatic plastic tube

LINKS TO RELATED DOCUMENTS	
Dimensions	www.vishay.com/doc?96156
Part marking information	www.vishay.com/doc?95391
SPIICE model	www.vishay.com/doc?96227



2L TO-220AC

DIMENSIONS in millimeters and inches

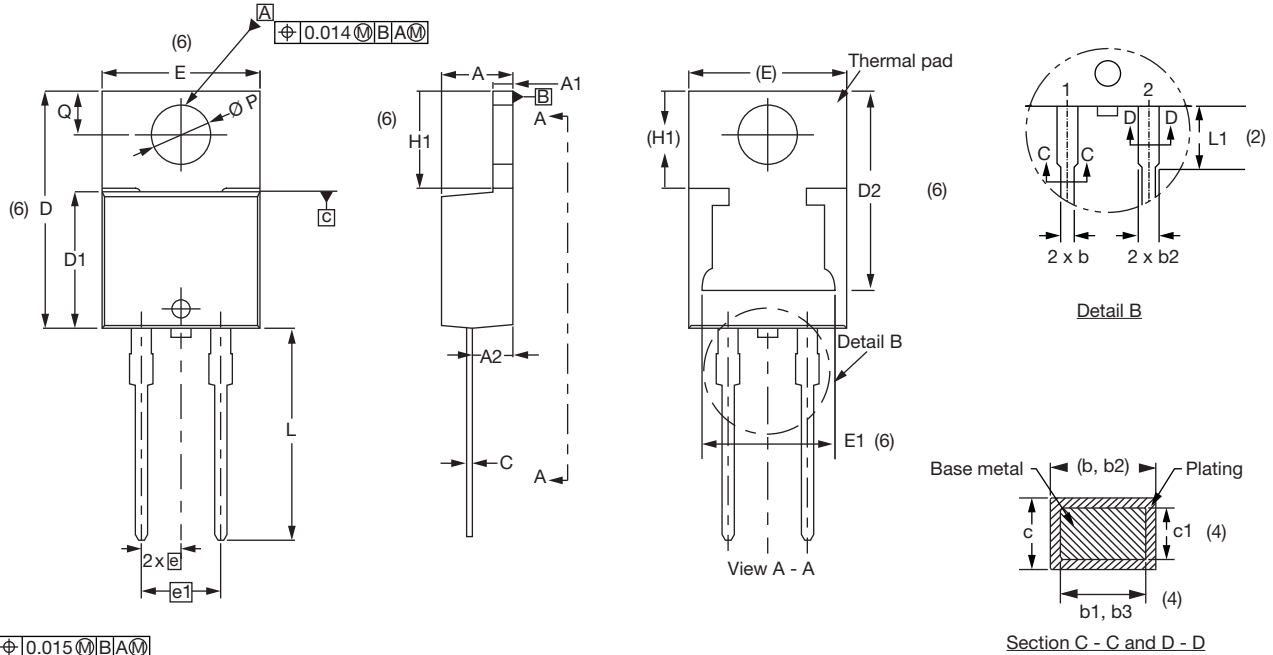

Conforms to JEDEC® outline TO-220AC

SYMBOL	MILLIMETERS		INCHES		NOTES	SYMBOL	MILLIMETERS		INCHES		NOTES
	MIN.	MAX.	MIN.	MAX.			MIN.	MAX.	MIN.	MAX.	
A	4.25	4.65	0.167	0.183		D2	11.68	13.30	0.460	0.524	6, 7
A1	1.14	1.40	0.045	0.055		E	10.11	10.51	0.398	0.414	3, 6
A2	2.50	2.92	0.098	0.115		E1	6.86	8.89	0.270	0.350	6
b	0.69	1.01	0.027	0.040		e	2.41	2.67	0.095	0.105	
b1	0.38	0.97	0.015	0.038	4	e1	4.88	5.28	0.192	0.208	
b2	1.20	1.73	0.047	0.068		H1	6.09	6.48	0.240	0.255	6
b3	1.14	1.73	0.045	0.068	4	L	13.52	14.02	0.532	0.552	
c	0.36	0.61	0.014	0.024		L1	3.32	3.82	0.131	0.150	2
c1	0.36	0.56	0.014	0.022	4	$\varnothing P$	3.54	3.91	0.139	0.154	
D	14.85	15.35	0.585	0.604	3	Q	2.60	3.00	0.102	0.118	
D1	8.38	9.02	0.330	0.355							

Notes

- (1) Dimensioning and tolerancing as per ASME Y14.5M-1994
- (2) Lead dimension and finish uncontrolled in L1
- (3) Dimension D, D1, and E do not include mold flash. Mold flash shall not exceed 0.127 mm (0.005") per side. These dimensions are measured at the outermost extremes of the plastic body
- (4) Dimension b1, b3, and c1 apply to base metal only
- (5) Controlling dimensions: inches
- (6) Thermal pad contour optional within dimensions E, H1, D2, and E1
- (7) Outline conforms to JEDEC® TO-220, except D2



Disclaimer

ALL PRODUCT, PRODUCT SPECIFICATIONS AND DATA ARE SUBJECT TO CHANGE WITHOUT NOTICE TO IMPROVE RELIABILITY, FUNCTION OR DESIGN OR OTHERWISE.

Vishay Intertechnology, Inc., its affiliates, agents, and employees, and all persons acting on its or their behalf (collectively, "Vishay"), disclaim any and all liability for any errors, inaccuracies or incompleteness contained in any datasheet or in any other disclosure relating to any product.

Vishay makes no warranty, representation or guarantee regarding the suitability of the products for any particular purpose or the continuing production of any product. To the maximum extent permitted by applicable law, Vishay disclaims (i) any and all liability arising out of the application or use of any product, (ii) any and all liability, including without limitation special, consequential or incidental damages, and (iii) any and all implied warranties, including warranties of fitness for particular purpose, non-infringement and merchantability.

Statements regarding the suitability of products for certain types of applications are based on Vishay's knowledge of typical requirements that are often placed on Vishay products in generic applications. Such statements are not binding statements about the suitability of products for a particular application. It is the customer's responsibility to validate that a particular product with the properties described in the product specification is suitable for use in a particular application. Parameters provided in datasheets and / or specifications may vary in different applications and performance may vary over time. All operating parameters, including typical parameters, must be validated for each customer application by the customer's technical experts. Product specifications do not expand or otherwise modify Vishay's terms and conditions of purchase, including but not limited to the warranty expressed therein.

Except as expressly indicated in writing, Vishay products are not designed for use in medical, life-saving, or life-sustaining applications or for any other application in which the failure of the Vishay product could result in personal injury or death. Customers using or selling Vishay products not expressly indicated for use in such applications do so at their own risk. Please contact authorized Vishay personnel to obtain written terms and conditions regarding products designed for such applications.

No license, express or implied, by estoppel or otherwise, to any intellectual property rights is granted by this document or by any conduct of Vishay. Product names and markings noted herein may be trademarks of their respective owners.