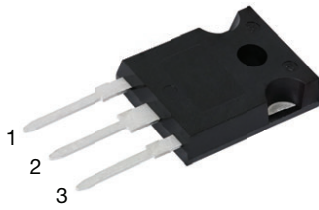
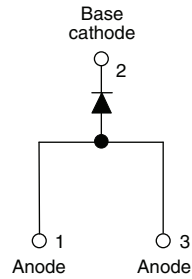

Fast Soft Recovery Rectifier Diode, 80 A

TO-247AC 3L

FEATURES

- Glass passivated pellet chip junction
- 150 °C max. operating junction temperature
- Low forward voltage drop and short reverse recovery time
- Designed and qualified according to JEDEC®-JESD 47
- Material categorization: for definitions of compliance please see www.vishay.com/doc?99912

RoHS
 COMPLIANT
 HALOGEN
FREE
 Available

APPLICATIONS

These devices are intended for use in output rectification and freewheeling in inverters, choppers and converters as well as in input rectification where severe restrictions on conducted EMI should be met.

DESCRIPTION

The VS-80APF12L-M3 soft recovery rectifier series has been optimized for combined short reverse recovery time and low forward voltage drop.

The glass passivation ensures stable reliable operation in the most severe temperature and power cycling conditions.

PRIMARY CHARACTERISTICS	
$I_{F(AV)}$	80 A
V_R	1000 V, 1200 V
V_F at I_F	1.35 V
I_{FSM}	1250 A
t_{rr}	90 ns
T_J max.	150 °C
Package	TO-247AC 3L
Circuit configuration	Single
Snap factor	0.5

MAJOR RATINGS AND CHARACTERISTICS			
SYMBOL	TEST CONDITIONS	VALUES	UNITS
V_{RRM}		1000/1200	V
$I_{F(AV)}$	Sinusoidal waveform	80	A
I_{FSM}		1250	
t_{rr}	1 A, - 100 A/μs	90	ns
V_F	40 A, $T_J = 25$ °C	1.2	V
T_J		-40 to +150	°C

VOLTAGE RATINGS			
PART NUMBER	V_{RRM} , MAXIMUM PEAK REVERSE VOLTAGE V	V_{RSM} , MAXIMUM NON-REPETITIVE PEAK REVERSE VOLTAGE V	I_{RRM} AT 150 °C mA
VS-80APF10-M3	1000	1100	15
VS-80APF12-M3	1200	1300	



ABSOLUTE MAXIMUM RATINGS				
PARAMETER	SYMBOL	TEST CONDITIONS	VALUES	UNITS
Maximum average forward current	$I_{F(AV)}$	$T_C = 92\text{ }^\circ\text{C}$, 180° conduction half sine wave	80	A
Maximum peak one cycle non-repetitive surge current	I_{FSM}	10 ms sine pulse, rated V_{RRM} applied	1100	
		10 ms sine pulse, no voltage reapplied	1250	
Maximum I^2t for fusing	I^2t	10 ms sine pulse, rated V_{RRM} applied	5000	A^2s
		10 ms sine pulse, no voltage reapplied	7000	
Maximum $I^2\sqrt{t}$ for fusing	$I^2\sqrt{t}$	$t = 0.1\text{ ms to }10\text{ ms}$, no voltage reapplied	70 000	$A^2\sqrt{s}$

ELECTRICAL SPECIFICATIONS					
PARAMETER	SYMBOL	TEST CONDITIONS	VALUES	UNITS	
Maximum forward voltage drop	V_{FM}	80 A, $T_J = 25\text{ }^\circ\text{C}$	1.35	V	
Forward slope resistance	r_t	$T_J = 150\text{ }^\circ\text{C}$	4.03	$m\Omega$	
Threshold voltage	$V_{F(TO)}$		0.87	V	
Maximum reverse leakage current	I_{RM}	$T_J = 25\text{ }^\circ\text{C}$	$V_R = \text{Rated } V_{RRM}$	0.1	mA
		$T_J = 150\text{ }^\circ\text{C}$		15	

RECOVERY CHARACTERISTICS				
PARAMETER	SYMBOL	TEST CONDITIONS	VALUES	UNITS
Reverse recovery time	t_{rr}	I_F at 80 A _{pk} 25 A/ μ s 25 °C	480	ns
Reverse recovery current	I_{rr}		7.1	A
Reverse recovery charge	Q_{rr}		2.1	μ C
Snap factor	S		0.5	

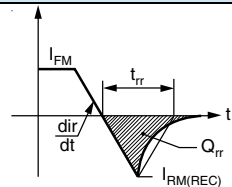

THERMAL - MECHANICAL SPECIFICATIONS				
PARAMETER	SYMBOL	TEST CONDITIONS	VALUES	UNITS
Maximum junction and storage temperature range	T_J, T_{Stg}		-40 to +150	$^\circ\text{C}$
Maximum thermal resistance, junction to case	R_{thJC}	DC operation	0.35	$^\circ\text{C/W}$
Maximum thermal resistance, junction to ambient	R_{thJA}		40	
Typical thermal resistance, case to heatsink	R_{thCS}	Mounting surface, smooth, and greased	0.2	
Approximate weight			6	g
			0.21	oz.
Mounting torque	minimum		6 (5)	$\text{kgf} \cdot \text{cm}$ ($\text{lbf} \cdot \text{in}$)
	maximum		12 (10)	
Marking device		Case style TO-247AC 3L	80APF10	
			80APF12	

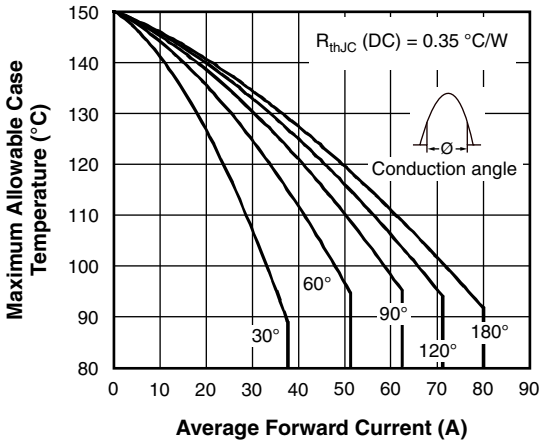

Fig. 1 - Current Rating Characteristics

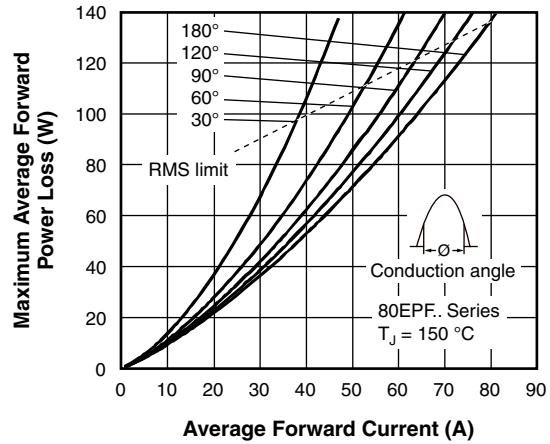

Fig. 4 - Forward Power Loss Characteristics

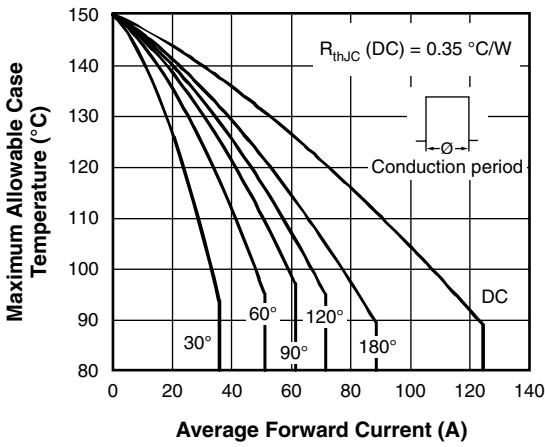

Fig. 2 - Current Rating Characteristics

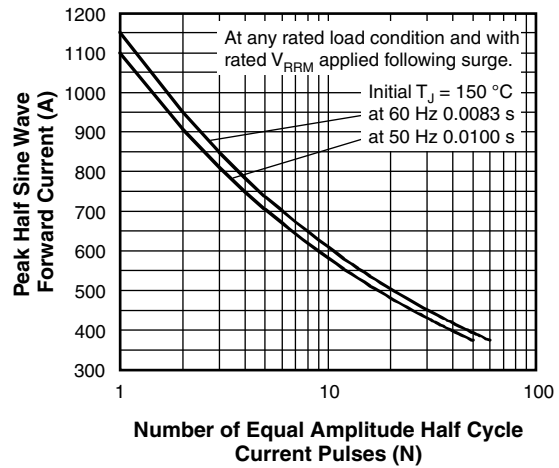

Fig. 5 - Maximum Non-Repetitive Surge Current

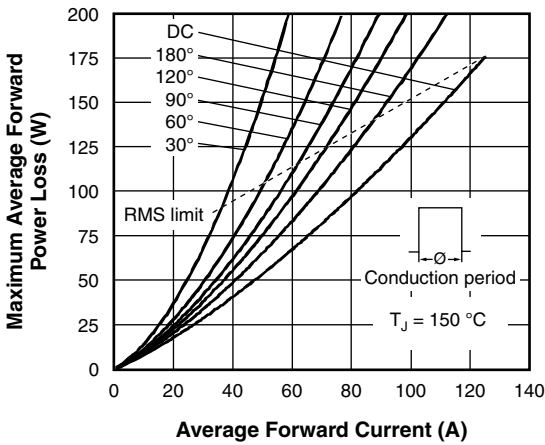

Fig. 3 - Forward Power Loss Characteristics

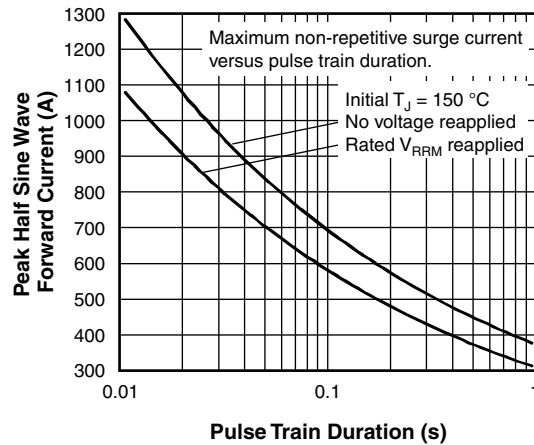

Fig. 6 - Maximum Non-Repetitive Surge Current

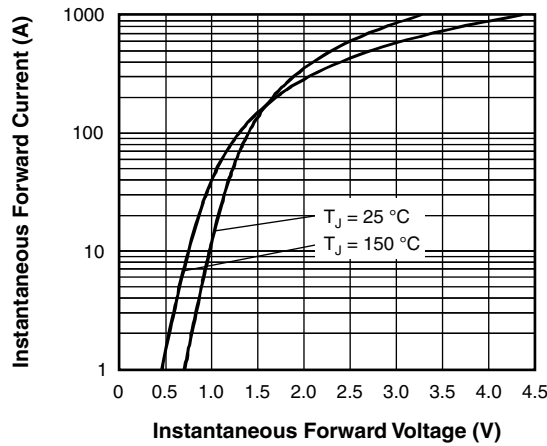

Fig. 7 - Forward Voltage Drop Characteristics

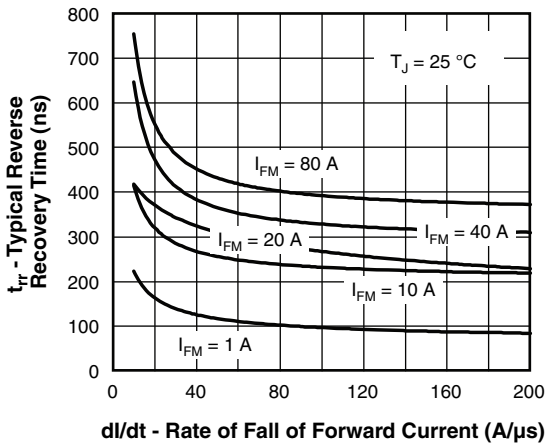

Fig. 8 - Recovery Time Characteristics, $T_J = 25\text{ }^\circ\text{C}$

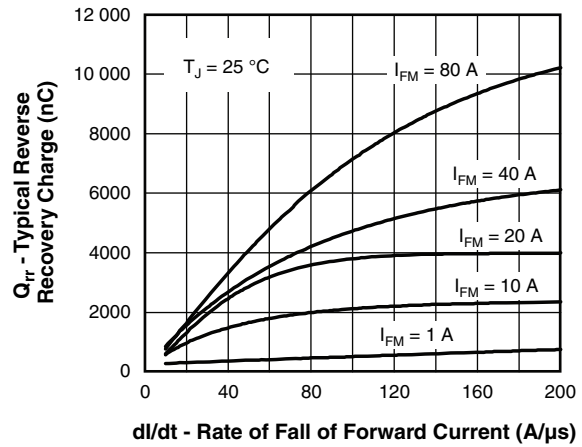

Fig. 10 - Recovery Charge Characteristics, $T_J = 25\text{ }^\circ\text{C}$

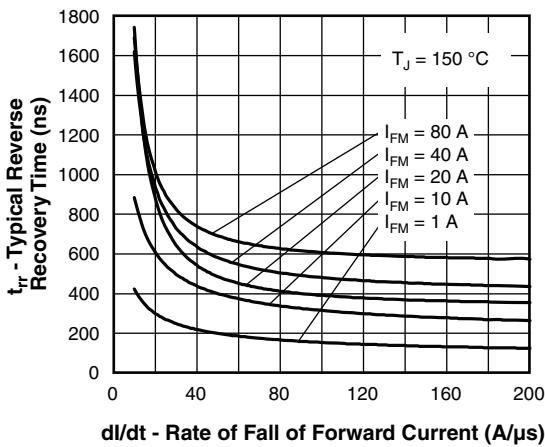

Fig. 9 - Recovery Time Characteristics, $T_J = 150\text{ }^\circ\text{C}$

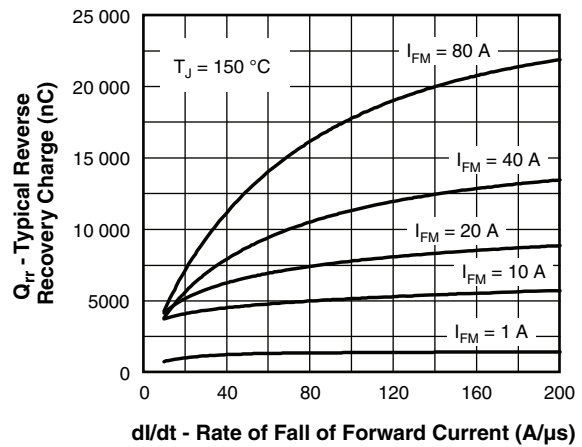

Fig. 11 - Recovery Charge Characteristics, $T_J = 150\text{ }^\circ\text{C}$

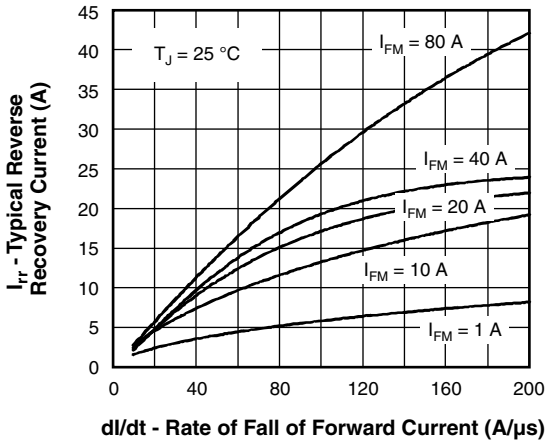

Fig. 12 - Recovery Current Characteristics, $T_J = 25\text{ }^\circ\text{C}$

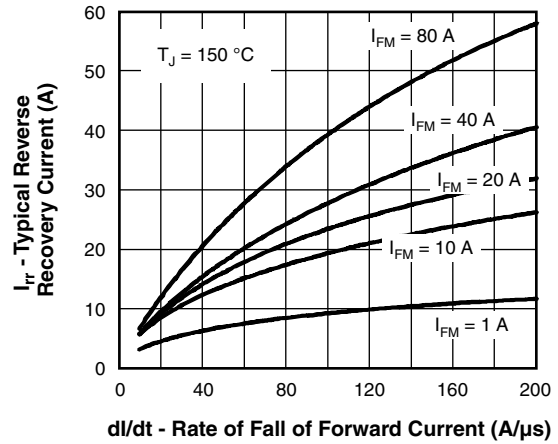

Fig. 13 - Recovery Current Characteristics, $T_J = 150\text{ }^\circ\text{C}$

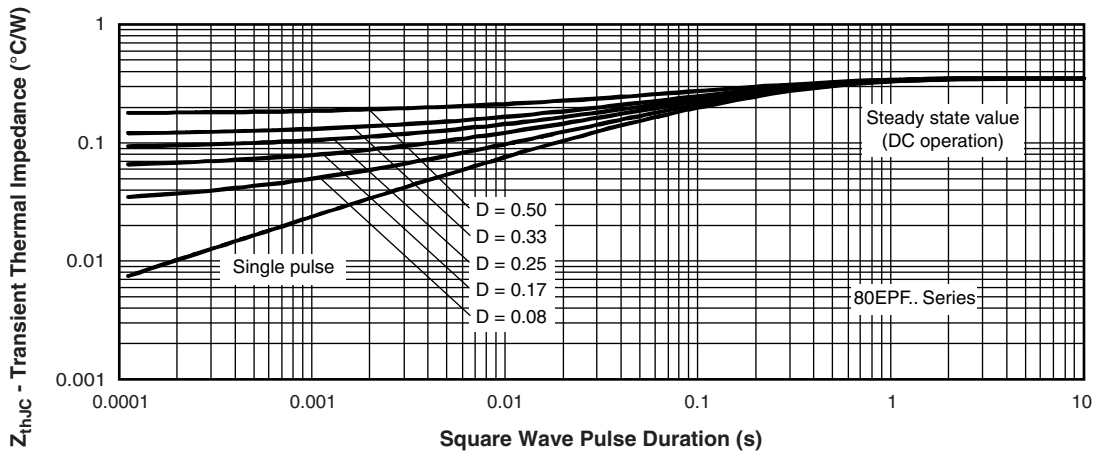
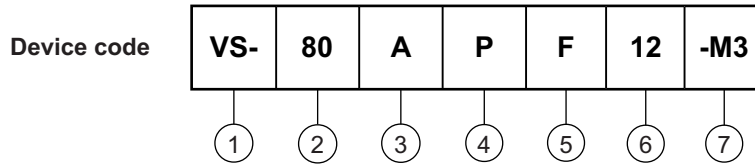

Fig. 14 - Thermal Impedance Z_{thJC} Characteristics



ORDERING INFORMATION TABLE



- 1** - Vishay Semiconductors product
- 2** - Current rating (80 = 80 A)
- 3** - Circuit configuration:
A = single diode, 3 pins
- 4** - Package:
P = TO-247AC 3L
- 5** - Type of silicon:
F = fast recovery
- 6** - Voltage code x 100 = V_{RRM}

10 = 1000 V
12 = 1200 V
- 7** - Environmental digit:
-M3 = halogen-free, RoHS-compliant, and terminations lead (Pb)-free

ORDERING INFORMATION (Example)			
PREFERRED P/N	QUANTITY PER T/R	MINIMUM ORDER QUANTITY	PACKAGING DESCRIPTION
VS-80APF10-M3	25	500	Antistatic plastic tubes
VS-80APF12-M3	25	500	Antistatic plastic tubes

LINKS TO RELATED DOCUMENTS	
Dimensions	www.vishay.com/doc?96138
Part marking information	www.vishay.com/doc?95007
SPICE model	www.vishay.com/doc?96692

TO-247AC 3L

DIMENSIONS in millimeters and inches

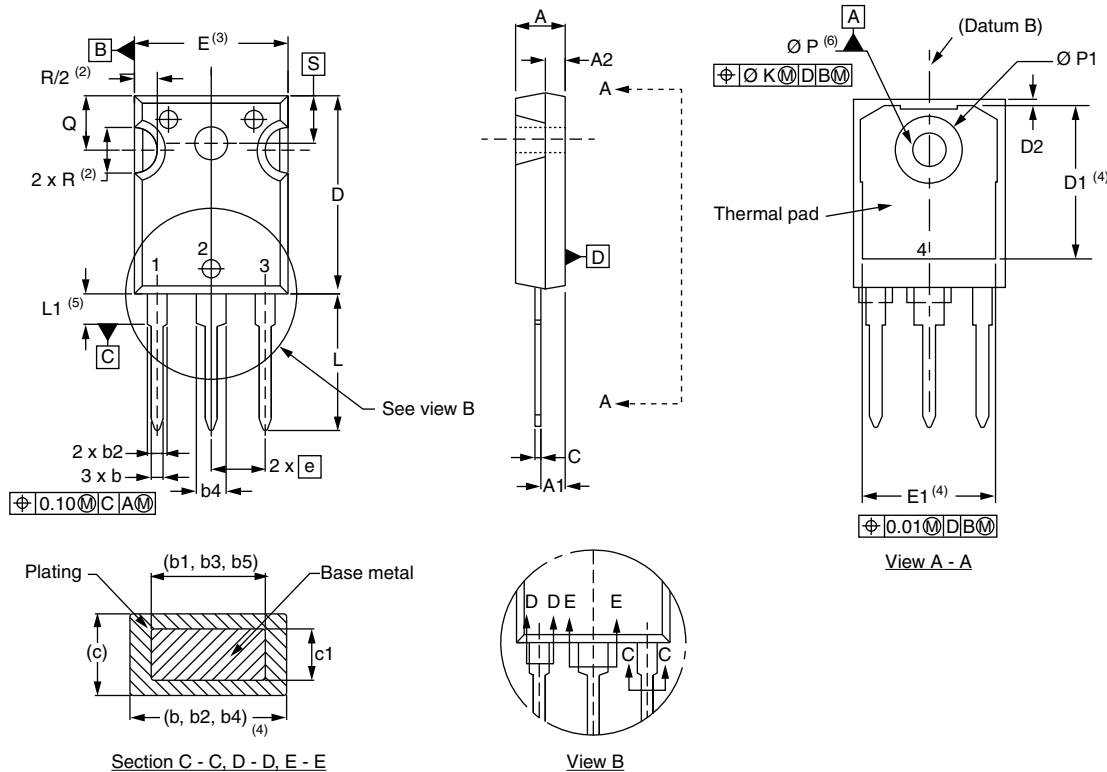

SYMBOL	MILLIMETERS		INCHES		NOTES
	MIN.	MAX.	MIN.	MAX.	
A	4.65	5.31	0.183	0.209	
A1	2.21	2.59	0.087	0.102	
A2	1.17	1.37	0.046	0.054	
b	0.99	1.40	0.039	0.055	
b1	0.99	1.35	0.039	0.053	
b2	1.65	2.39	0.065	0.094	
b3	1.65	2.34	0.065	0.092	
b4	2.59	3.43	0.102	0.135	
b5	2.59	3.38	0.102	0.133	
c	0.38	0.89	0.015	0.035	
c1	0.38	0.84	0.015	0.033	
D	19.71	20.70	0.776	0.815	3
D1	13.08	-	0.515	-	4
D2	0.51	1.35	0.020	0.053	
E	15.29	15.87	0.602	0.625	3
E1	13.46	-	0.53	-	
e	5.46 BSC		0.215 BSC		
Ø K	0.254		0.010		
L	14.20	16.10	0.559	0.634	
L1	3.71	4.29	0.146	0.169	
Ø P	3.56	3.66	0.14	0.144	
Ø P1	-	7.39	-	0.291	
Q	5.31	5.69	0.209	0.224	
R	4.52	5.49	0.178	0.216	
S	5.51 BSC		0.217 BSC		

Notes

- (1) Dimensioning and tolerancing per ASME Y14.5M-1994
- (2) Contour of slot optional
- (3) Dimension D and E do not include mold flash. Mold flash shall not exceed 0.127 mm (0.005") per side. These dimensions are measured at the outermost extremes of the plastic body
- (4) Thermal pad contour optional with dimensions D1 and E1
- (5) Lead finish uncontrolled in L1
- (6) Ø P to have a maximum draft angle of 1.5 to the top of the part with a maximum hole diameter of 3.91 mm (0.154")
- (7) Outline conforms to JEDEC® outline TO-247 with exception of dimension Q



Disclaimer

ALL PRODUCT, PRODUCT SPECIFICATIONS AND DATA ARE SUBJECT TO CHANGE WITHOUT NOTICE TO IMPROVE RELIABILITY, FUNCTION OR DESIGN OR OTHERWISE.

Vishay Intertechnology, Inc., its affiliates, agents, and employees, and all persons acting on its or their behalf (collectively, "Vishay"), disclaim any and all liability for any errors, inaccuracies or incompleteness contained in any datasheet or in any other disclosure relating to any product.

Vishay makes no warranty, representation or guarantee regarding the suitability of the products for any particular purpose or the continuing production of any product. To the maximum extent permitted by applicable law, Vishay disclaims (i) any and all liability arising out of the application or use of any product, (ii) any and all liability, including without limitation special, consequential or incidental damages, and (iii) any and all implied warranties, including warranties of fitness for particular purpose, non-infringement and merchantability.

Statements regarding the suitability of products for certain types of applications are based on Vishay's knowledge of typical requirements that are often placed on Vishay products in generic applications. Such statements are not binding statements about the suitability of products for a particular application. It is the customer's responsibility to validate that a particular product with the properties described in the product specification is suitable for use in a particular application. Parameters provided in datasheets and / or specifications may vary in different applications and performance may vary over time. All operating parameters, including typical parameters, must be validated for each customer application by the customer's technical experts. Product specifications do not expand or otherwise modify Vishay's terms and conditions of purchase, including but not limited to the warranty expressed therein.

Except as expressly indicated in writing, Vishay products are not designed for use in medical, life-saving, or life-sustaining applications or for any other application in which the failure of the Vishay product could result in personal injury or death. Customers using or selling Vishay products not expressly indicated for use in such applications do so at their own risk. Please contact authorized Vishay personnel to obtain written terms and conditions regarding products designed for such applications.

No license, express or implied, by estoppel or otherwise, to any intellectual property rights is granted by this document or by any conduct of Vishay. Product names and markings noted herein may be trademarks of their respective owners.