

MODEL NO : TM050JDHG33**MODEL VERSION: 00****SPEC VERSION : 3.0****ISSUED DATE: 2016-12-29**

- Preliminary Specification
 Final Product Specification

Customer : _____

Approved by	Notes

TIANMA Confirmed :

Prepared by	Checked by	Approved by
Lifeng Chen		

This technical specification is subjected to change without notice

Table of Contents

Table of Contents	2
Record of Revision.....	3
1 General Specifications	4
2 Input/Output Terminals	5
3 Absolute Maximum Ratings	6
4 Electrical Characteristics.....	7
5 Timing Chart.....	9
6 Optical Characteristics	14
7 Environmental / Reliability Test	17
8 Mechanical Drawing	18
9 Packing Drawing	19
10 Precautions for Use of LCD Modules	20

TIANMA CONFIDENTIAL

1 General Specifications

	Feature	Spec
Display Spec.	Size	4.99
	Resolution	720(RGB)×1280
	Technology Type	SFT
	Pixel Configuration	Vertical Strip
	Pixel pitch(mm)	0.08625×0.08625
	Display Mode	Normally Black
	Surface Treatment	Clear
	Viewing Direction	All direction
	Gray Scale Inversion Direction	NA
Mechanical Characteristics	LCM (W x H x D) (mm)	65.40*118.90*1.72
	Active Area(mm)	62.10*110.40
	With /Without TSP	Without TSP
	Matching Connection Type	B2B
	LED Numbers	12 LED
	Weight (g)	27
Electrical Characteristics	Interface	MIPI 4 lanes
	Color Depth	16.7M
	Driver IC	ILI9881C

Note 1: Viewing direction for best image quality is different from TFT definition. There is a 180 degree shift.

Note 2: Requirements on Environmental Protection: Q/S0002

Note 3: LCM weight tolerance: ± 5%

2 Input/Output Terminals

Pin No.	Symbol	I/O	Function	Remark
1	GND	P	Ground	
2	GND	P	Ground	
3	VDD	P	Analogy Power Supply	
4	D3-	I	MIPI Data Lane 3-	
5	GND	P	Ground	
6	D3+	I	MIPI Data Lane 3+	
7	MTP	P	Programming Power	
8	GND	P	Ground	
9	GND	P	Ground	
10	D0-	I	MIPI Data Lane 0-	
11	LED-	P	Cathode 1 of LED	
12	D0+	I	MIPI Data Lane 0+	
13	GND	P	Ground	
14	GND	P	Ground	
15	LED+	P	Anode of LED	
16	CK-	I	MIPI Clock Lane-	
17	GND	P	Ground	
18	CK+	I	MIPI Clock Lane+	
19	LED2-	P	Cathode 2 of LED	
20	GND	P	Ground	
21	GND	P	Ground	
22	D1-	I	MIPI Data Lane 1-	
23	VDDIO	P	Digital Power Supply	
24	D1+	I	MIPI Data Lane 1+	
25	GND	P	Ground	
26	GND	P	Ground	
27	TE	I	Tearing Effect	
28	D2-	I	MIPI Data Lane 2-	
29	GND	P	Ground	

30	D2+	I	MIPI Data Lane 2+	
31	LED_PWM	P	Backlight Control PWM Signal	
32	GND	P	Ground	
33	GND	P	Ground	
34	RESX	I	Reset Signal	

Note1: Please add the FPC connector type and matched one if necessary .

3 Absolute Maximum Ratings

GND=0V

Item	Symbol	MIN	MAX	Unit	Remark
Power Voltage	VCC	-0.3	6.5	V	Note1
Input voltage	V _{IN}	-0.3	3.9	V	
Operating Temperature	Top	-20	70	°C	
Storage Temperature	Tst	-30	80	°C	
Relative Humidity Note2	RH	--	≤95	%	Ta≤40°C
		--	≤85	%	40°C < Ta ≤ 50°C
		--	≤55	%	50°C < Ta ≤ 60°C
		--	≤36	%	60°C < Ta ≤ 70°C
		--	≤24	%	70°C < Ta ≤ 80°C
Absolute Humidity	AH	--	≤70	g/m ³	Ta > 70°C

Table 3 Absolute Maximum Ratings

Note1: Input voltage include VCI, VDDIO, MIPI lanes, CK+,CK-

Note2: Ta means the ambient temperature.

It is necessary to limit the relative humidity to the specified temperature range.

Condensation on the module is not allowed.

4 Electrical Characteristics

4.1 Driving TFT LCD Panel

Item	Symbol	MIN	TYP	MAX	Unit	Remark
Supply Voltage	VCC	2.5	2.8	6.0	V	
IO Supply Voltage	VDDIO	1.65	1.8	3.3	V	
Input Signal Voltage	Low Level	VIL	-0.3	—	0.3* VDDIO	V
	High Level	VIH	0.7* VDDIO	—	VDDIO	V
Output Signal Voltage	Low Level	VOL	0	—	0.2*VDDIO	V
	High Level	VOH	0.8*VDDIO	—	VDDIO	V
(Panel+LSI) Power Consumption	Black Mode (60Hz)	-	100	120	mW	
	Standby Mode	-	2	4	mW	

4.2 Backlight Unit

Item	Symbol	MIN	TYP	MAX	Unit	Remark
Forward Current	I_F	-	20	30	mA	One LED
Forward Voltage	V_F	-	3.2	3.4	V	One LED
Backlight Power Consumption	W_{BL}	-	768	1224	mW	One LED
LED life Time	-	10000	20000	-	-	One LED

Note1: The LED driving condition is defined for each LED module (6 LED Serial, 2 LED Parallel).

Note2: Under LCM operating, the stable forward current should be inputted. And forward voltage is for reference only.

Note3: I_F is defined for one channel LED. Optical performance should be evaluated at $T_a=25^\circ\text{C}$ only if LED is driven by high current, high ambient temperature & Humidity condition. The life time of LED will be reduced. Operating life means brightness goes down to 50% initial brightness. Typical operating life time is estimated data.

Note4: The LED driving condition is defined for each LED module.

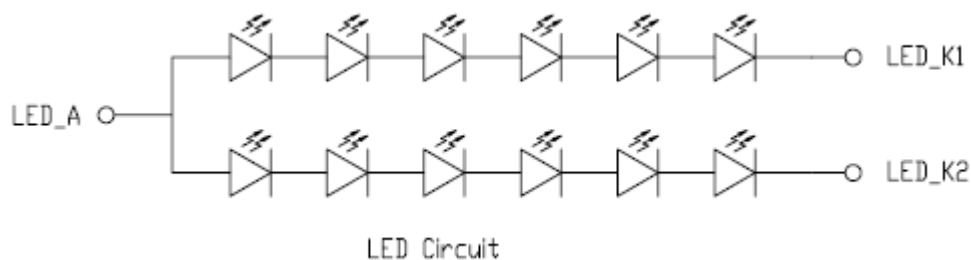

5 Block Diagram

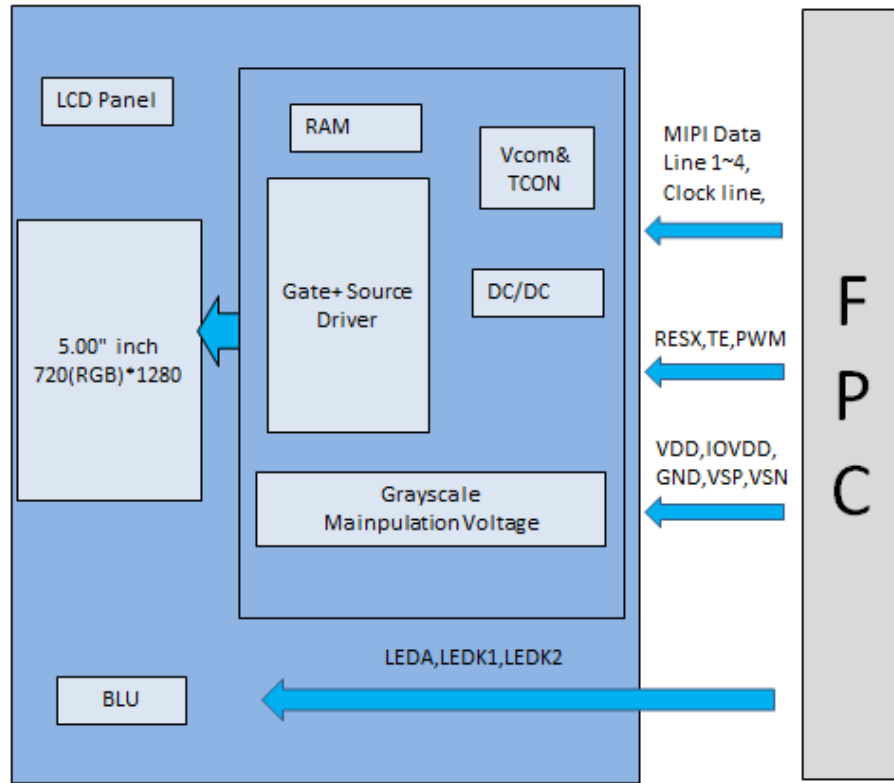

6 Timing Chart

6.1 High Speed Serial Electrical Characteristics:

6.1.1 Clock Channel Timing

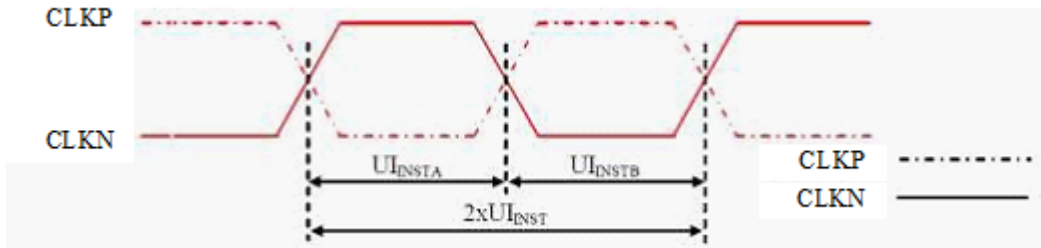

Figure 6.1.1 DSI Clock Channel Timing

Signal	Symbol	Parameter	Min	Max	Unit
CLKP/N	$2xUI_{INST}$	Double UI instantaneous	4	25	ns
CLKP/N	UI_{INSTA}, UI_{INSTB} (Note 1)	UI instantaneous Half	2 (Note 2)	12.5	ns

Table 6.1.1 DSI Clock Channel Timing

Notes:

1. $UI=UI_{INSTA}=UI_{INSTB}$
2. Define the minimum value of 24 ui per Pixel ,see table 6.1.1.1

Data type	Two Lanes speed	Three Lanes speed	Four Lanes speed
Data Type = 00 1110 (0Eh), RGB 565, 16 UI per Pixel	566 Mbps	433 Mbps	366 Mbps
Data Type = 01 1110 (1Eh), RGB 666, 18 UI per Pixel	637 Mbps	487 Mbps	412 Mbps
Data Type = 10 1110 (2Eh), RGB 666 Loosely, 24 UI per Pixel	850 Mbps	650 Mbps	550 Mbps
Data Type = 11 1110 (3Eh), RGB 888, 24 UI per Pixel	850 Mbps	650 Mbps	550 Mbps

Table 6.1.1.1 Limited Clock Channel Timing

6.1.2 Data Clock Timing

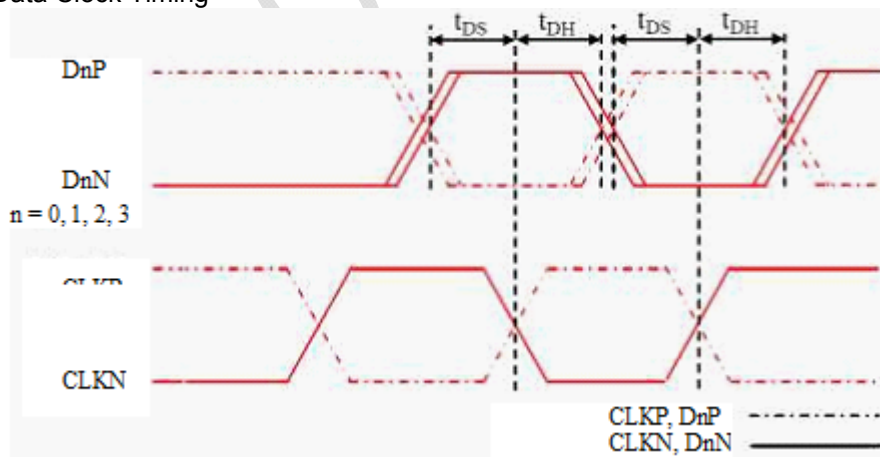

Figure 6.1.2 DSI Data to Clock Channel Timing

Signal	Symbol	Parameter	Min	Max
DnP/N , n=0 and 1	t_{DS}	Data to Clock Setup time	$0.15xUI$	-
	t_{DH}	Clock to Data Hold Time	$0.15xUI$	-

Table 6.1.2 DSI Data to Clock Channel Timing

The information contained herein is the exclusive property of TIANMA MICRO-ELECTRONICS Corporation and shall not be distributed, reproduced, or disclosed in whole or in part without prior written permission of TIANMA MICRO-ELECTRONICS Corporation.

6.1.3 Rising and Falling Timing

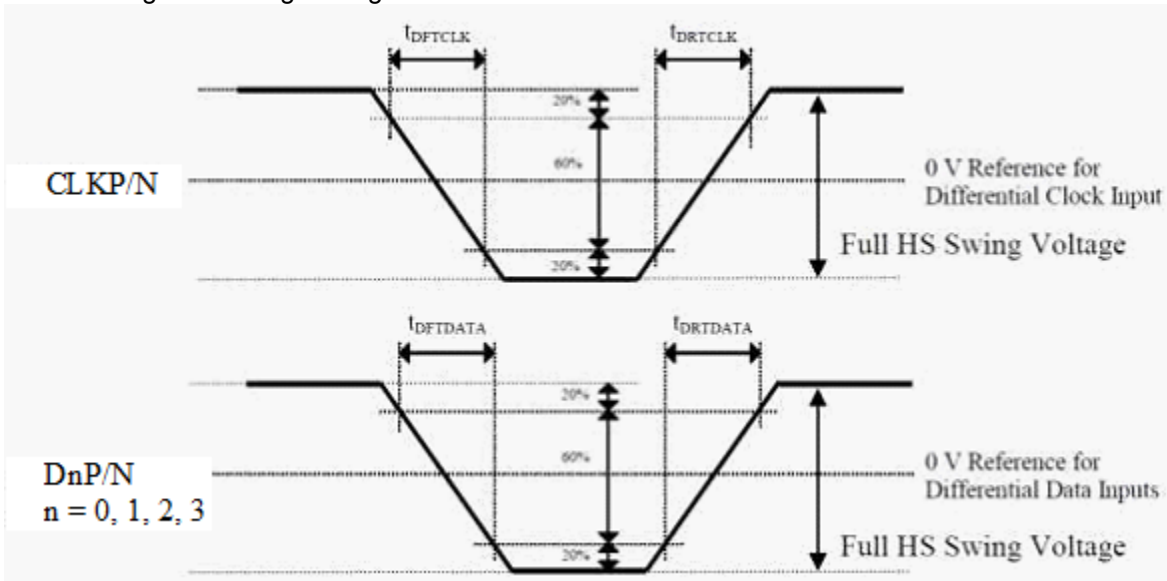

Figure 6.1.3 Rising and Falling Timings on Clock and Data Channels

Parameter	Symbol	Condition	Specification		
			Min	Typ	Max
Differential Rise Time for Clock	t_{DRTCLK}	CLKP/N	150 ps	-	0.3UI (Note)
Differential Rise Time for Data	$t_{DRTDATA}$	DnP/N n=0 and 1	150 ps	-	0.3UI (Note)
Differential Fall Time for Clock	t_{DFTCLK}	CLKP/N	150 ps	-	0.3UI (Note)
Differential Fall Time for Data	$t_{DFTDATA}$	DnP/N n=0 and 1	150 ps	-	0.3UI (Note)

Table 6.1.3 Rise and Fall Timings on Clock and Data Channels

6.2 Low Speed Mode Electrical Characteristics
Bus Turn Around

Lower Power Mode and its State Periods on the Bus Turnaround (BTA) from the MCU to the Display Module (ILI9881C-01000GA) are illustrated for reference purposes below.

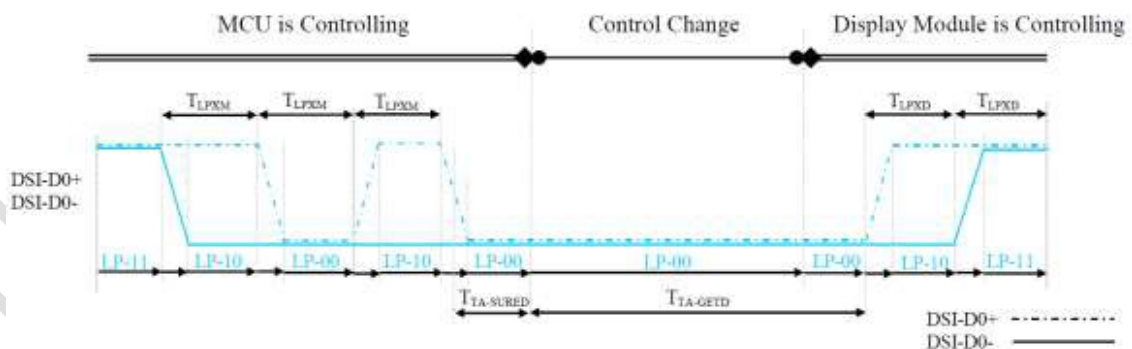

Figure 6.2.1 BTA from the MCU to the Display Module

Lower Power Mode and its State Periods on the Bus Turnaround (BTA) from the Display Module (ILI9881C-01000GA) to the MCU are illustrated for reference purposes below.

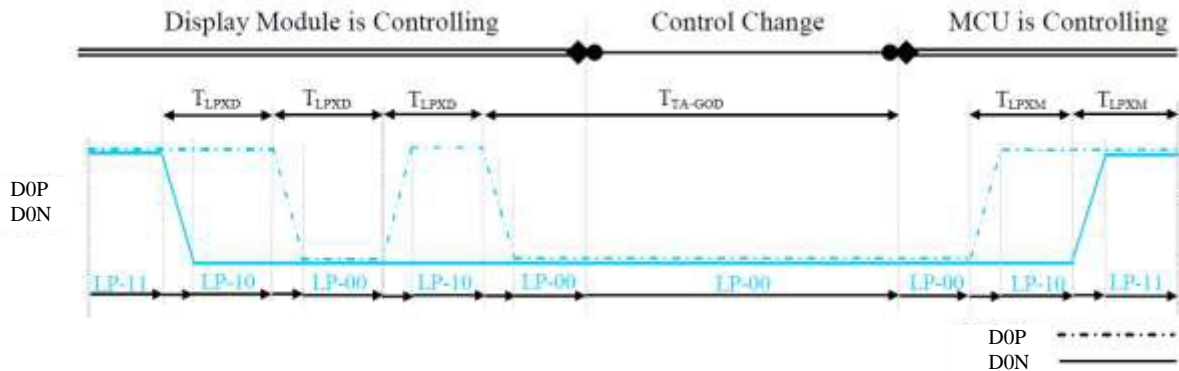

Figure 6.2.2 BTA from the Display to the MCU

Signal	Symbol	Description	Min	Max	Unit
D0P/N	T_{LPXM}	Length of LP-00, LP-01, LP-10 or LP-11 periods MCU → Display Module (ILI9881C-01000GA)	50	75	ns
D0P/N	T_{LPXD}	Length of LP-00, LP-01, LP-10 or LP-11 periods Display Module (ILI9881C-01000GA) → MCU	50	75	ns
D0P/N	$T_{TA-SURED}$	Time-out before the Display Module (ILI9881C-01000GA) starts driving	T_{LPXD}	$2 \times T_{LPXD}$	ns

Table 6.2.1 Low Power State Period Timings-A

Signal	Symbol	Description	Time	Unit
D0P/N	$T_{TA-GETD}$	Time to drive LP-00 by Display Module (ILI9881C-01000GA)	$5 \times T_{LPXD}$	ns
D0P/N	T_{TA-GOD}	Time to drive LP-00 after turnaround request - MCU	$4 \times T_{LPXD}$	ns

Table 6.2.2 Low Power State Period Timings-B

6.3 Data Lanes from Low Power Mode to High Speed Mode

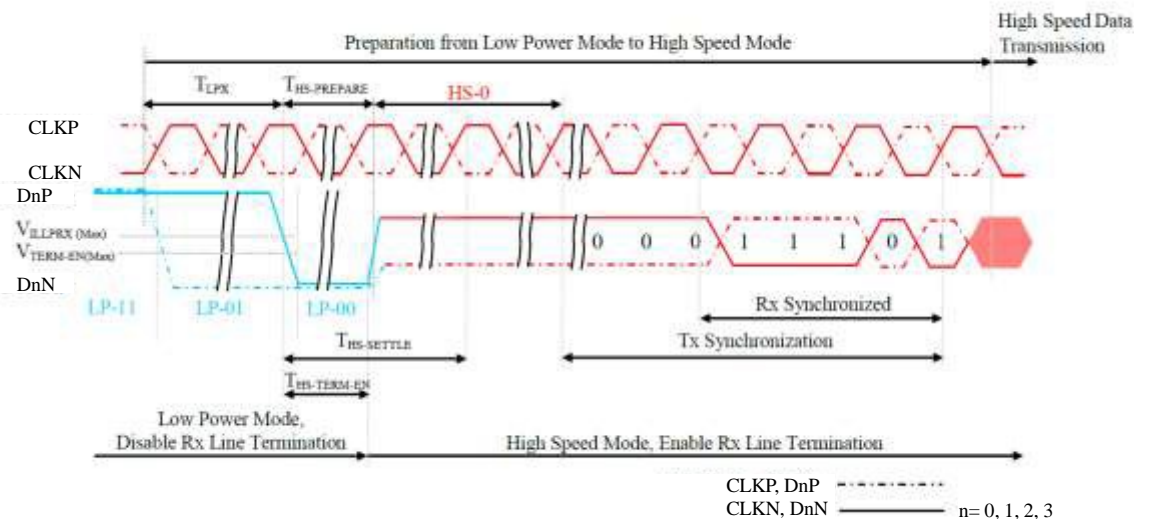

Figure 6.3 Data Lanes – Low Power Mode to High Speed Mode Timings

Signal	Symbol	Description	Min	Max	Unit
DnP/N, n = 0 and 1	T_{LPX}	Length of any Low Power State Period	50	-	ns
DnP/N, n = 0 and 1	$T_{HS-PREPARE}$	Time to drive LP-00 to prepare for HS Transmission	$40+4xUI$	$85+6xUI$	ns
DnP/N, n = 0 and 1	$T_{HS-TERM-EN}$	Time to enable Data Lane Receiver line termination measured from when Dn crosses VILMAX	-	$35+4xUI$	ns

Table 6.3 Data Lanes – Low Power Mode to High Speed Mode Timings

6.4 Data Lanes from High Speed Mode to Low Power Mode

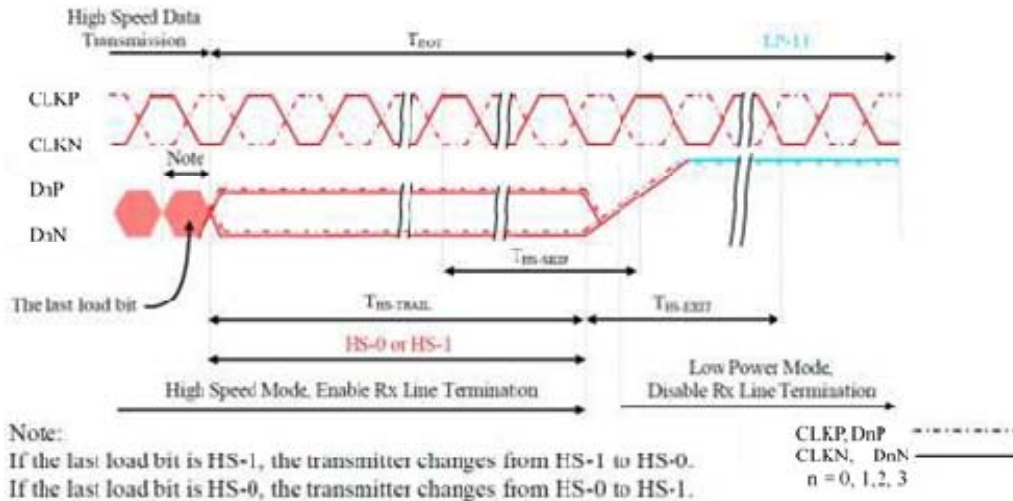

Figure 6.4 Data lanes – High Speed Mode to Low Power Mode Timings

Signal	Symbol	Description	Min	Max	Unit
DnP/N, n = 0 and 1	$T_{HS-SKIP}$	Time-Out at Display Module (ILI9881C-01000GA) to ignore transition period of EoT	40	$55+4xUI$	ns
DnP/N, n = 0 and 1	$T_{HS-EXIT}$	Time to driver LP-11 after HS burst	100	-	ns

Table 6.4 Data lanes – High Speed Mode to Low Power Mode Timings

6.5 DSI Clock Burst – High Speed Mode to/from Low Power Mode

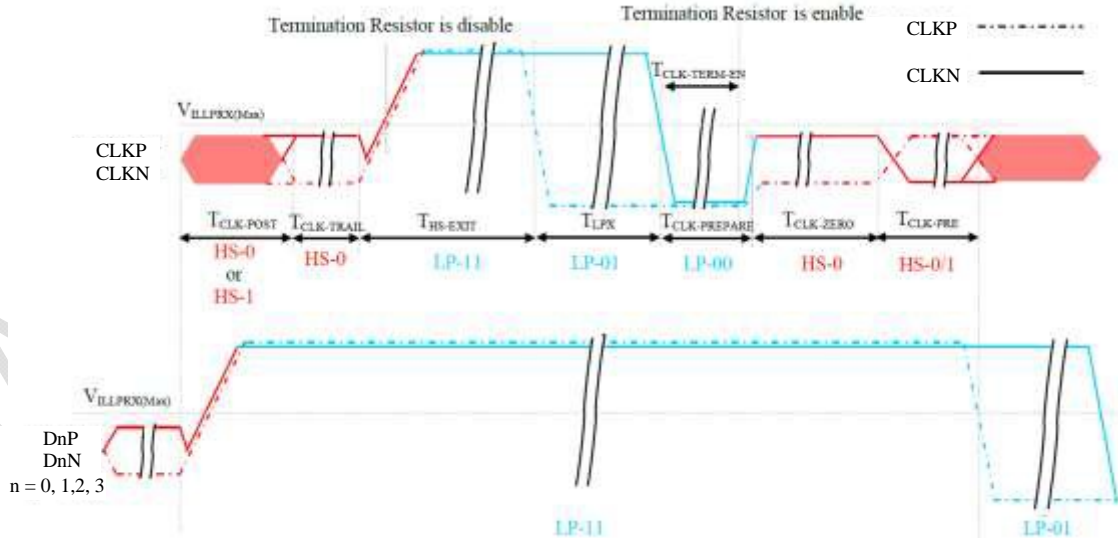

Figure 6.5 Clock Lanes - High Speed Mode to/from Low Power Mode Timings

Signal	Symbol	Description	Min	Max	Unit
CLKP/N	$T_{CLK-POST}$	Time that the MCU shall continue sending HS clock after the last associated Data Lanes has transitioned to LP mode	60+52xUI	-	ns
CLKP/N	$T_{CLK-TRAIL}$	Time to drive HS differential state after last payload clock bit of a HS transmission burst	60	-	ns
CLKP/N	$T_{HS-EXIT}$	Time to drive LP-11 after HS burst	100	-	ns
CLKP/N	$T_{CLK-PREPARE}$	Time to drive LP-00 to prepare for HS transmission	38	95	ns
CLKP/N	$T_{CLK-TERM-EN}$	Time-out at Clock Lane to enable HS termination	-	38	ns
CLKP/N	$T_{CLK-PREPARE} + T_{CLK-ZERO}$	Minimum lead HS-0 drive period before starting Clock	300	-	ns
CLKP/N	$T_{CLK-PRE}$	Time that the HS clock shall be driven prior to any associated Data Lane beginning the transition from LP to HS mode	8xUI	-	ns

Table 6.5 Clock Lanes - High Speed Mode to/from Low Power Mode Timings

6.6 Power On/Off Sequence

6.6.1 Power On Sequence

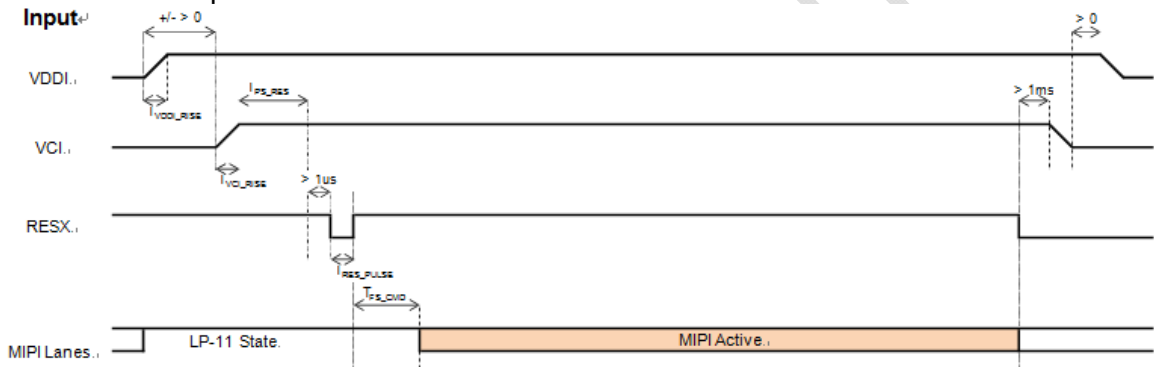

Symbol	Characteristics	Min.	Typ.	Max.	Units
T_{VDDI_RISE}	VDDI Rise time	20	-	-	us
T_{VCI_RISE}	Case A: VCI Rise time	200	-	-	us
	Case B: VCI Rise time	40			
T_{PS_RES}	VDDI/VCI on to Reset high	5	-	-	ms
T_{RES_PULSE}	Reset low pulse time	10	-	-	us
T_{FS_CMD}	Reset to first command	10	-	-	ms

Figure 6.6.1 Power On Sequence

6.6.2 Uncontrolled Power Off

The uncontrolled power off means a situation when a battery is removed without the controlled power off sequence. There will not be any damages for the display module, or the display module will not cause any damages for the host or lines of the interface. At an uncontrolled power off event, the ILI9881C will force the display to become blank and will not have any abnormal visible effects within 1 second on the display and remains blank until the Power On Sequence powers it up.

7 Optical Characteristics

Item	Symbol	Condition	Min	Typ	Max	Unit	Remark
View Angles	θT	$CR \geq 10$	75	80		Degree	Note2,3
	θB		75	80			
	θL		75	80			
	θR		75	80			
Contrast Ratio	CR	$\theta=0^\circ$	600	800			Note 3
Response Time	T_{ON}	25°C		30	35	ms	Note 4
	T_{OFF}						
Chromaticity	White	Backlight is on	x	0.282	0.312	0.342	Note 1,5
			y	0.311	0.341	0.371	
	Red		x	0.613	0.643	0.673	Note 1,5
			y	0.295	0.325	0.355	
	Green		x	0.281	0.311	0.341	Note 1,5
			y	0.603	0.633	0.663	
	Blue		x	0.125	0.155	0.185	Note 1,5
			y	0.028	0.058	0.088	
Uniformity	U		75	80		%	Note 6
NTSC				70		%	Note 5
Luminance	L		480	600		cd/m ²	Note 7

Test Conditions:

1. $I_F = 20$ mA, and the ambient temperature is 25°C.
2. The test systems refer to Note 1 and Note 2.

Note 1: Definition of optical measurement system.

The optical characteristics should be measured in dark room. After 5 Minutes operation, the optical properties are measured at the center point of the LCD screen. All input terminals LCD panel must be ground when measuring the center area of the panel.

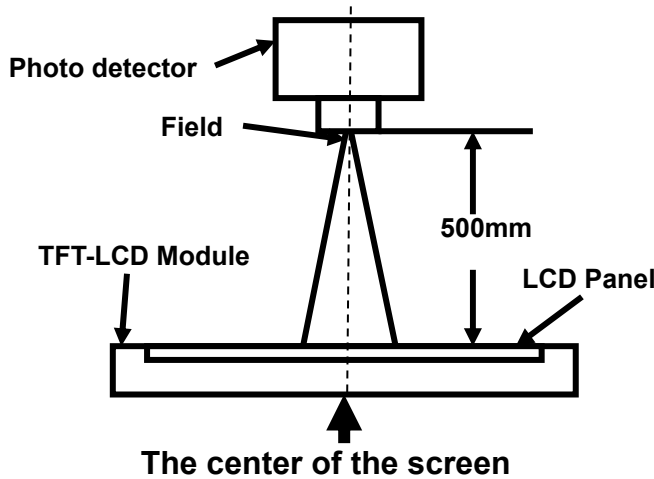

Item	Photo detector	Field
Contrast Ratio	SR-3A	1°
Luminance		
Chromaticity		
Lum Uniformity		
Response Time	BM-7A	2°

Note 2: Definition of viewing angle range and measurement system.

viewing angle is measured at the center point of the LCD by CONOSCOPE(ergo-80).

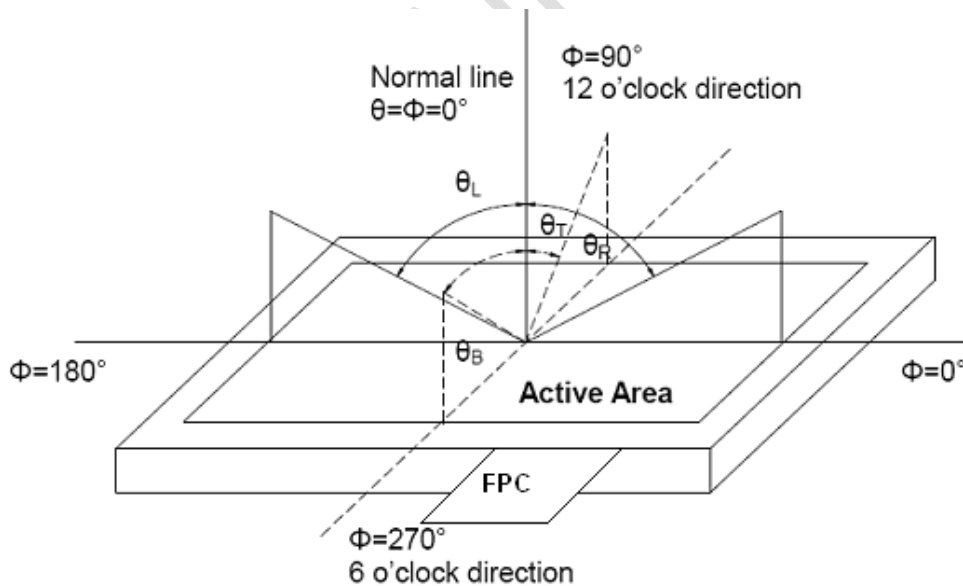

Note 3: Definition of contrast ratio

$$\text{Contrast ratio (CR)} = \frac{\text{Luminance measured when LCD is on the "White" state}}{\text{Luminance measured when LCD is on the "Black" state}}$$

“White state “: The state is that the LCD should drive by V_{white}.

“Black state”: The state is that the LCD should drive by V_{black}.

Vwhite: To be determined Vblack: To be determined.

Note 4: Definition of Response time

The response time is defined as the LCD optical switching time interval between “White” state and “Black” state. Rise time (T_{ON}) is the time between photo detector output intensity changed from 90% to 10%. And fall time (T_{OFF}) is the time between photo detector output intensity changed from 10% to 90%.

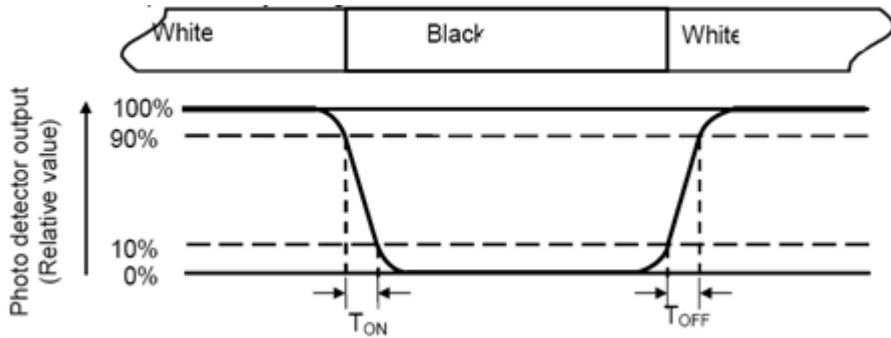

Note 5: Definition of color chromaticity (CIE1931)

Color coordinates measured at center point of LCD.

Note 6: Definition of Luminance Uniformity

Active area is divided into 9 measuring areas (Refer Fig. 2). Every measuring point is placed at the center of each measuring area.

$$\text{Luminance Uniformity (U)} = L_{\min} / L_{\max}$$

L-----Active area length W----- Active area width

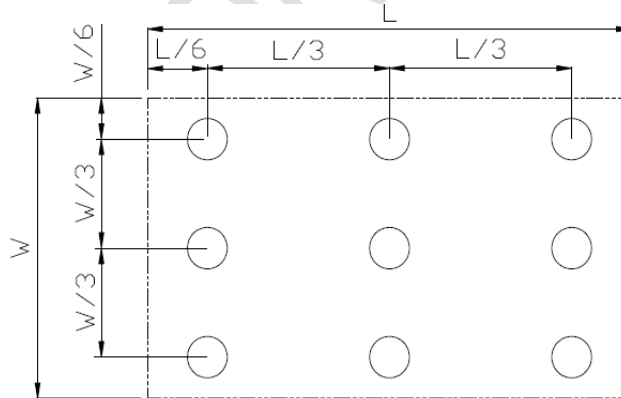

L_{max}: The measured Maximum luminance of all measurement position.

L_{min}: The measured Minimum luminance of all measurement position.

Note 7: Definition of Luminance:

Measure the luminance of white state at center point.

8 Environmental / Reliability Test

No	Test Item	Condition	Remarks
1	High Temperature Operation	Ts=+70℃ , 240 hours	IEC60068-2-1:2007 GB2423.2-2008
2	Low Temperature Operation	Ta=-20℃ , 240 hours	IEC60068-2-1:2007 GB2423.1-2008
3	High Temperature Storage	Ta=+80℃ , 240 hours	IEC60068-2-1:2007 GB2423.2-2008
4	Low Temperature Storage	Ta=-30℃ , 240 hours	IEC60068-2-1:2007 GB2423.1-2008
5	Storage at High Temperature and Humidity	Ta=+60℃ , 90% RH 240 hours	IEC60068-2-78 :2001 GB/T2423.3—2006
6	Thermal Shock (non-operation)	-30℃ 30min ~+80℃ 30min , Change time : 5min , 20 cycles	Start with cold temperature, End with high temperature, IEC60068-2-14:1984, GB2423.22-2002
7	ESD	C=150pF,R=330Ω, 5 point/panel, Air: ±8KV, 5 times; Contact ±4KV,5times (Environment:15℃ ~35℃,30%~60%,80Kpa~106Kpa)	IEC61000-4-2:2001 GB/T17626.2-2006
8	Vibration Test	Frequency range:10~55Hz Stroke:1.5mm Sweep:10Hz~55Hz~10Hz 2 hours for each direction of X.Y.Z(6 hours for total)(package condition)	IEC60068-2-6:1982 GB/T2423.10—1995
9	Mechanical Shock (Non OP)	60G 6ms, ±X, ±Y, ±Z 3 times for each direction	IEC60068-2-27:1987 GB/T2423.5—1995
10	Package Drop Test	Height:80cm,1corner,3edges,6surfaces	IEC60068-2-32:1990 GB/T2423.8—1995

Note1: Ts is the temperature of panel's surface.

Note2: Ta is the ambient temperature of sample.

Note3: Before cosmetic and function test, the product must have enough recovery time, at least 2 hours at room temperature.

Note 4: In the standard condition, there shall be no practical problem that may affect the display function. After the reliability test, the product only guarantees operation, but don't guarantee all of the cosmetic specification.

10 Packing Drawing

No	Item	Model (Materiel)	Dimensions(mm)	Unit Weight(Kg)	Quantity	Remark
1	LCM Module	TM050JDHG33-00	118.9X65.4X1.72mm	0.027	192	
2	Tray	PET (Transmit)	485×330×13.8	0.167	27	Anti-static
3	Dust-Proof	PE	700×545	0.046	1	
4	BOX	Corrugated Paper	520×345×74	0.369	3	
5	Desiccant	Desiccant	45×50	0.002	6	
6	EPE	EPE	485*330*5	19	3	
7	Carton	Corrugated Paper	544×365×250	0.76	1	
8	Label	Label	100*52	-	1	
9	Total Weight			11.675		

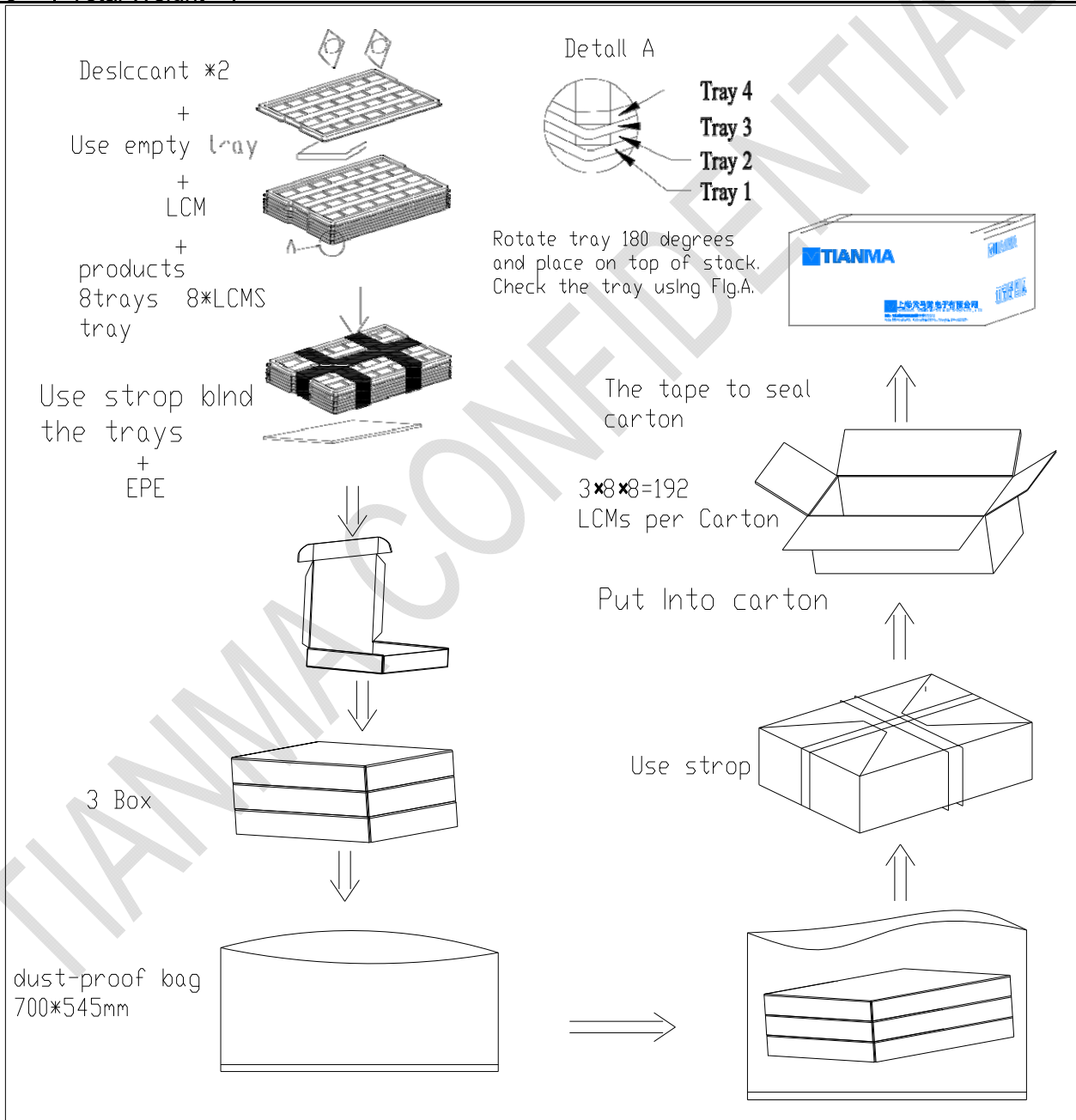

The information contained herein is the exclusive property of TIANMA MICRO-ELECTRONICS Corporation and shall not be distributed, reproduced, or disclosed in whole or in part without prior written permission of TIANMA MICRO-ELECTRONICS Corporation.

11 Precautions for Use of LCD Modules

11.1 Handling Precautions

11.1.1 The display panel is made of glass. Do not subject it to a mechanical shock by dropping it from a high place, etc.

11.1.2 If the display panel is damaged and the liquid crystal substance inside it leaks out, be sure not to get any in your mouth, if the substance comes into contact with your skin or clothes, promptly wash it off using soap and water.

11.1.3 Do not apply excessive force to the display surface or the adjoining areas since this may cause the color tone to vary.

11.1.4 The polarizer covering the display surface of the LCD module is soft and easily scratched. Handle this polarizer carefully.

11.1.5 If the display surface is contaminated, breathe on the surface and gently wipe it with a soft dry cloth. If still not completely clear, moisten cloth with one of the following solvents:

- Isopropyl alcohol
- Ethyl alcohol

Solvents other than those mentioned above may damage the polarizer. Especially, do not use the following:

- Water
- Ketone
- Aromatic solvents

11.1.6 Do not attempt to disassemble the LCD Module.

11.1.7 If the logic circuit power is off, do not apply the input signals.

11.1.8 To prevent destruction of the elements by static electricity, be careful to maintain an optimum work environment.

10.1.8.1 Be sure to ground the body when handling the LCD Modules.

10.1.8.2 Tools required for assembly, such as soldering irons, must be properly ground.

10.1.8.3 To reduce the amount of static electricity generated, do not conduct assembly and other work under dry conditions.

10.1.8.4 The LCD Module is coated with a film to protect the display surface. Be care when peeling off this protective film since static electricity may be generated.

11.2 Storage precautions

11.2.1 When storing the LCD modules, avoid exposure to direct sunlight or to the light of fluorescent lamps.

11.2.2 The LCD modules should be stored under the storage temperature range. If the LCD modules will be stored for a long time, the recommend condition is:

Temperature : 0°C ~ 40°C Relatively humidity: ≤80%

11.2.3 The LCD modules should be stored in the room without acid, alkali and harmful gas.

11.3 Transportation Precautions

11.3.1 The LCD modules should be no falling and violent shocking during transportation, and also should avoid excessive press, water, damp and sunshine.