

## Ultrafast Rectifier

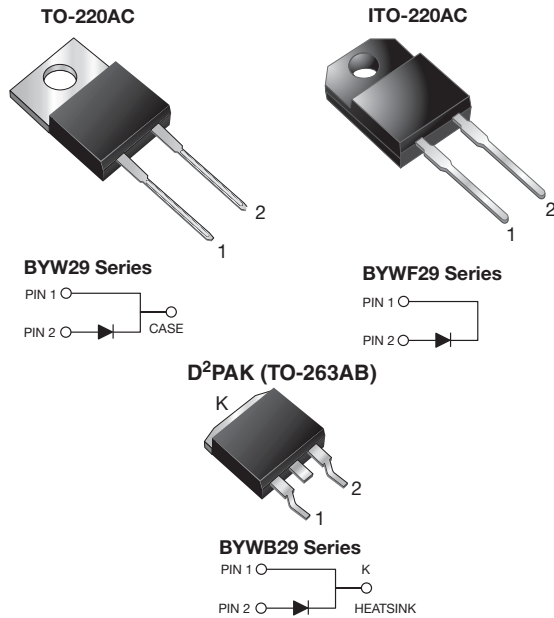

### FEATURES

- Power pack
- Glass passivated pellet chip junction
- Ultrafast recovery time
- Low switching losses, high efficiency
- Low forward voltage drop
- High forward surge capability
- Meets MSL level 1, per J-STD-020, LF maximum peak of 245 °C (D<sup>2</sup>PAK (TO-263AB package))
- Solder dip 275 °C max. 10 s, per JESD 22-B106 (for TO-220AC and ITO-220AC package)
- AEC-Q101 qualified available
  - Automotive ordering code: base P/NHE3 (for ITO-220AC and D<sup>2</sup>PAK (TO-263AB package))
- Material categorization: for definitions of compliance please see [www.vishay.com/doc?99912](http://www.vishay.com/doc?99912)

**RoHS**  
COMPLIANT

### DESIGN SUPPORT TOOLS AVAILABLE



3D Models

PRIMARY CHARACTERISTICS	
$I_{F(AV)}$	8.0 A
$V_{RRM}$	50 V to 200 V
$I_{FSM}$	100 A
$t_{rr}$	25 ns
$V_F$	0.8 V
$T_J$ max.	150 °C
Package	TO-220AC, ITO-220AC, D <sup>2</sup> PAK (TO-263AB)
Circuit configurations	Single

### TYPICAL APPLICATIONS

For use in high frequency rectifier of switching mode power supplies, inverters, freewheeling diodes, DC/DC converters, and other power switching application.

### MECHANICAL DATA

**Case:** TO-220AC, ITO-220AC, D<sup>2</sup>PAK (TO-263AB)

Molding compound meets UL 94 V-0 flammability rating

Base P/N-E3 - RoHS-compliant, commercial grade

Base P/NHE3\_X - RoHS-compliant and AEC-Q101 qualified ("\_X" denotes revision code e.g. A, B,...)

**Terminals:** matte tin plated leads, solderable per J-STD-002 and JESD 22-B102

E3 suffix meets JESD 201 class 1A whisker test, HE3 suffix meets JESD 201 class 2 whisker test

**Polarity:** as marked

**Mounting Torque:** 10 in-lbs max.

MAXIMUM RATINGS ( $T_C = 25$ °C unless otherwise noted)						
PARAMETER	SYMBOL	BYW29-50	BYW29-100	BYW29-150	BYW29-200	UNIT
Maximum repetitive peak reverse voltage	$V_{RRM}$	50	100	150	200	V
Maximum RMS voltage	$V_{RMS}$	35	70	105	140	V
Maximum DC blocking voltage	$V_{DC}$	50	100	150	200	V
Maximum average forward rectified current at $T_C = 105$ °C	$I_{F(AV)}$	8.0				A
Peak forward surge current 8.3 ms single half sine-wave superimposed on rated load	$I_{FSM}$	100				A
Operating and storage temperature range	$T_J, T_{STG}$	-65 to +150				°C
Isolation voltage (ITO-220AC only) from terminal to heatsink $t = 1$ min	$V_{AC}$	1500				V



<b>ELECTRICAL CHARACTERISTICS</b> ( $T_C = 25\text{ }^\circ\text{C}$ unless otherwise noted)								
PARAMETER	TEST CONDITIONS		SYMBOL	BYW29-50	BYW29-100	BYW29-150	BYW29-200	UNIT
Maximum instantaneous forward voltage	$I_F = 20\text{ A}$	$T_J = 25\text{ }^\circ\text{C}$	$V_F^{(1)}$	1.3				V
	$I_F = 8.0\text{ A}$	$T_J = 150\text{ }^\circ\text{C}$		0.8				
Maximum DC reverse current at rated DC blocking voltage			$I_R$	10				$\mu\text{A}$
				500				
Maximum reverse recovery time	$I_F = 1\text{ A}$ , $V_R = 30\text{ V}$ , $di/dt = 100\text{ A}/\mu\text{s}$ , $I_{rr} = 10\% I_{RM}$		$t_{rr}$	25				ns
Typical junction capacitance	4.0 V, 1 MHz		$C_J$	45				pF

**Note**(1) Pulse test: 300  $\mu\text{s}$  pulse width, 1 % duty cycle

<b>THERMAL CHARACTERISTICS</b> ( $T_C = 25\text{ }^\circ\text{C}$ unless otherwise noted)					
PARAMETER	SYMBOL	BYW	BYWF	BYWB	UNIT
Typical thermal resistance from junction to case per leg	$R_{\theta JC}$	2.5	5.5	2.5	$^\circ\text{C}/\text{W}$

<b>ORDERING INFORMATION</b> (Example)					
PACKAGE	PREFERRED P/N	UNIT WEIGHT (g)	PACKAGE CODE	BASE QUANTITY	DELIVERY MODE
TO-220AC	BYW29-200-E3/45	1.80	45	50/tube	Tube
ITO-220AC	BYWF29-200-E3/45	1.95	45	50/tube	Tube
D <sup>2</sup> PAK (TO-263AB)	BYWB29-200-E3/45	1.77	45	50/tube	Tube
D <sup>2</sup> PAK (TO-263AB)	BYWB29-200-E3/81	1.77	81	800/reel	Tape and reel
ITO-220AC	BYWF29-200HE3_A/P <sup>(1)</sup>	1.95	P	50/tube	Tube
D <sup>2</sup> PAK (TO-263AB)	BYWB29-200HE3_A/P <sup>(1)</sup>	1.77	P	50/tube	Tube
D <sup>2</sup> PAK (TO-263AB)	BYWB29-200HE3_A/I <sup>(1)</sup>	1.77	I	800/reel	Tape and reel

**Note**

(1) AEC-Q101 qualified, available in ITO-220AC and TO-263AB package

**RATINGS AND CHARACTERISTICS CURVES** ( $T_A = 25\text{ }^\circ\text{C}$  unless otherwise noted)

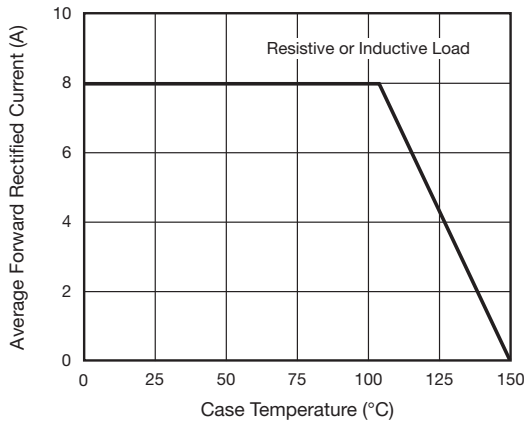

Fig. 1 - Maximum Forward Current Derating Curve

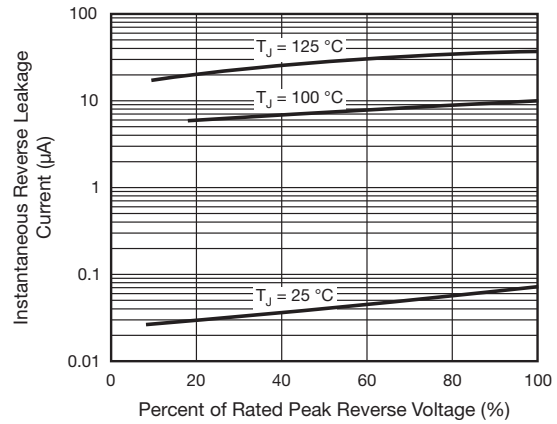

Fig. 4 - Typical Reverse Leakage Characteristics

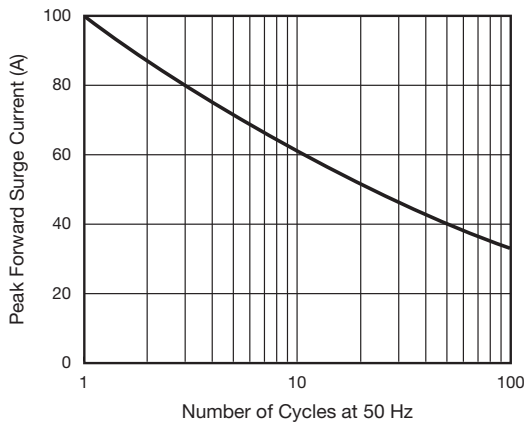

Fig. 2 - Maximum Non-Repetitive Peak Forward Surge Current

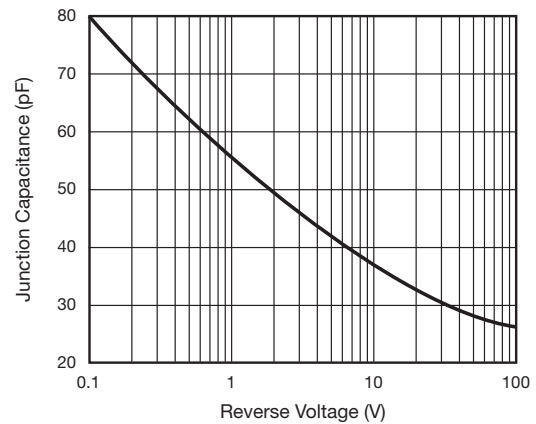

Fig. 5 - Typical Junction Capacitance

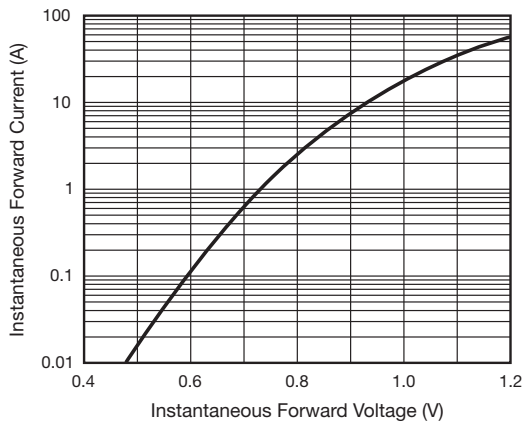
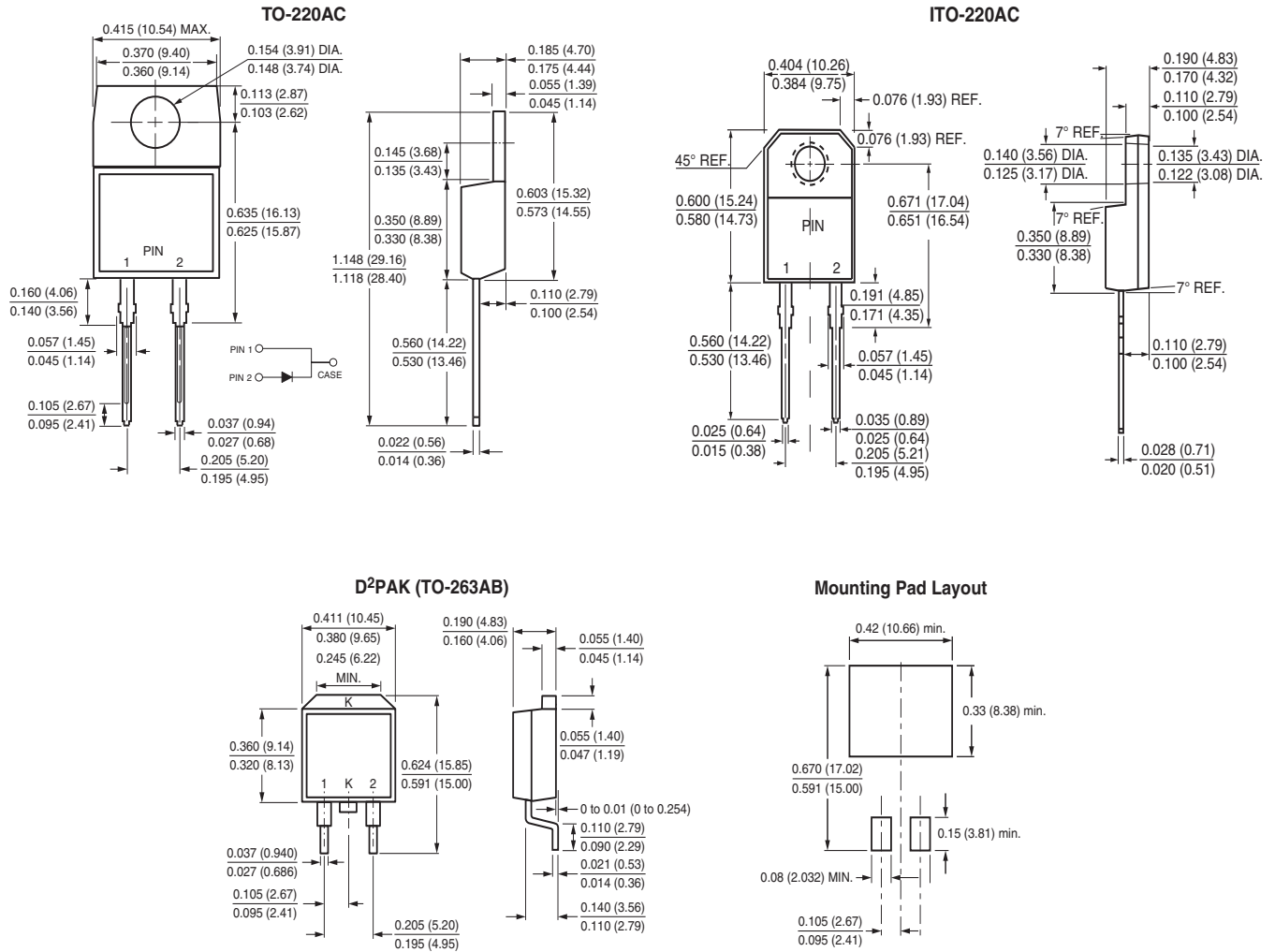

Fig. 3 - Typical Instantaneous Forward Characteristics



PACKAGE OUTLINE DIMENSIONS in inches (millimeters)





## **Disclaimer**

ALL PRODUCT, PRODUCT SPECIFICATIONS AND DATA ARE SUBJECT TO CHANGE WITHOUT NOTICE TO IMPROVE RELIABILITY, FUNCTION OR DESIGN OR OTHERWISE.

Vishay Intertechnology, Inc., its affiliates, agents, and employees, and all persons acting on its or their behalf (collectively, "Vishay"), disclaim any and all liability for any errors, inaccuracies or incompleteness contained in any datasheet or in any other disclosure relating to any product.

Vishay makes no warranty, representation or guarantee regarding the suitability of the products for any particular purpose or the continuing production of any product. To the maximum extent permitted by applicable law, Vishay disclaims (i) any and all liability arising out of the application or use of any product, (ii) any and all liability, including without limitation special, consequential or incidental damages, and (iii) any and all implied warranties, including warranties of fitness for particular purpose, non-infringement and merchantability.

Statements regarding the suitability of products for certain types of applications are based on Vishay's knowledge of typical requirements that are often placed on Vishay products in generic applications. Such statements are not binding statements about the suitability of products for a particular application. It is the customer's responsibility to validate that a particular product with the properties described in the product specification is suitable for use in a particular application. Parameters provided in datasheets and / or specifications may vary in different applications and performance may vary over time. All operating parameters, including typical parameters, must be validated for each customer application by the customer's technical experts. Product specifications do not expand or otherwise modify Vishay's terms and conditions of purchase, including but not limited to the warranty expressed therein.

Except as expressly indicated in writing, Vishay products are not designed for use in medical, life-saving, or life-sustaining applications or for any other application in which the failure of the Vishay product could result in personal injury or death. Customers using or selling Vishay products not expressly indicated for use in such applications do so at their own risk. Please contact authorized Vishay personnel to obtain written terms and conditions regarding products designed for such applications.

No license, express or implied, by estoppel or otherwise, to any intellectual property rights is granted by this document or by any conduct of Vishay. Product names and markings noted herein may be trademarks of their respective owners.