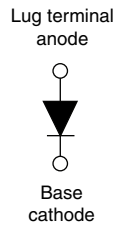

High Performance Schottky Rectifier, 120 A

HALF-PAK (D-67)

FEATURES

- 150 °C T_J operation
- Low forward voltage drop
- High frequency operation
- Guard ring for enhanced ruggedness and long term reliability
- Designed and qualified for industrial level
- UL approved file E222165
- Material categorization: for definitions of compliance please see www.vishay.com/doc?99912

RoHS
COMPLIANT

PRIMARY CHARACTERISTICS

I _{F(AV)}	120 A
V _R	45 V
Package	HALF-PAK (D-67)
Circuit	Single diode

DESCRIPTION

The VS-120NQ.. high current Schottky rectifier module series has been optimized for low reverse leakage at high temperature. The proprietary barrier technology allows for reliable operation up to 150 °C junction temperature. Typical applications are in high current switching power supplies, plating power supplies, UPS systems, converters, freewheeling diodes, welding, and reverse battery protection.

MAJOR RATINGS AND CHARACTERISTICS

SYMBOL	CHARACTERISTICS	VALUES	UNITS
I _{F(AV)}	Rectangular waveform	120	A
V _R		45	V
I _{FSM}	t _p = 5 μs sine	26 000	A
V _F	120 A _{pk} , T _J = 125 °C	0.62	V
T _J	Range	-55 to +150	°C

VOLTAGE RATINGS

PARAMETER	SYMBOL	VS-120NQ045PbF	UNITS
Maximum DC reverse voltage	V _R	45	V
Maximum working peak reverse voltage	V _{RWM}		

ABSOLUTE MAXIMUM RATINGS

PARAMETER	SYMBOL	TEST CONDITIONS	VALUES	UNITS
Maximum average forward current See fig. 5	I _{F(AV)}	50 % duty cycle at T _C = 105 °C, rectangular waveform	120	A
Maximum peak one cycle non-repetitive surge current See fig. 7	I _{FSM}	5 μs sine or 3 μs rect. pulse	26 000	
		10 ms sine or 6 ms rect. pulse	1550	
Non-repetitive avalanche energy	E _{AS}	T _J = 25 °C, I _{AS} = 13 A, L = 1 mH	81	mJ
Repetitive avalanche current	I _{AR}	Current decaying linearly to zero in 1 μs Frequency limited by T _J maximum V _A = 1.5 x V _R typical	13	A



ELECTRICAL SPECIFICATIONS					
PARAMETER	SYMBOL	TEST CONDITIONS		VALUES	UNITS
Maximum forward voltage drop See fig. 1	$V_{FM}^{(1)}$	120 A	$T_J = 25\text{ }^\circ\text{C}$	0.63	V
		240 A		0.86	
		120 A	$T_J = 125\text{ }^\circ\text{C}$	0.62	
		240 A		0.81	
Maximum reverse leakage current See fig. 2	$I_{RM}^{(1)}$	$T_J = 25\text{ }^\circ\text{C}$	$V_R = \text{Rated } V_R$	10	mA
		$T_J = 125\text{ }^\circ\text{C}$		500	
Maximum junction capacitance	C_T	$V_R = 5 V_{DC}$ (test signal range 100 kHz to 1 MHz) $25\text{ }^\circ\text{C}$		5200	pF
Typical series inductance	L_S	From top of terminal hole to mounting plane		7.0	nH
Maximum voltage rate of change	dV/dt	Rated V_R		10 000	V/ μs

Note

(1) Pulse width < 500 μs

THERMAL - MECHANICAL SPECIFICATIONS					
PARAMETER	SYMBOL	TEST CONDITIONS		VALUES	UNITS
Maximum junction and storage temperature range	T_J, T_{Stg}			-55 to 150	$^\circ\text{C}$
Maximum thermal resistance, junction to case	R_{thJC}	DC operation See fig. 4		0.38	$^\circ\text{C}/\text{W}$
Typical thermal resistance, case to heatsink	R_{thCS}	Mounting surface, smooth, and greased		0.05	
Approximate weight				30	g
				1.06	oz.
Mounting torque	minimum	Non-lubricated threads		3 (26.5)	N · m (lbf · in)
	maximum			4 (35.4)	
Terminal torque	minimum			3.4 (30)	
	maximum			5 (44.2)	
Case style			HALF-PAK module		

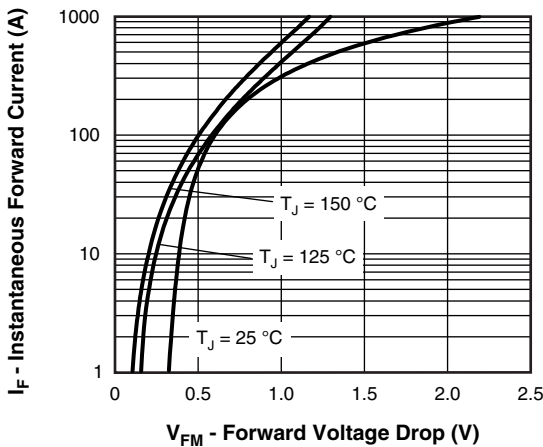

Fig. 1 - Maximum Forward Voltage Drop Characteristics

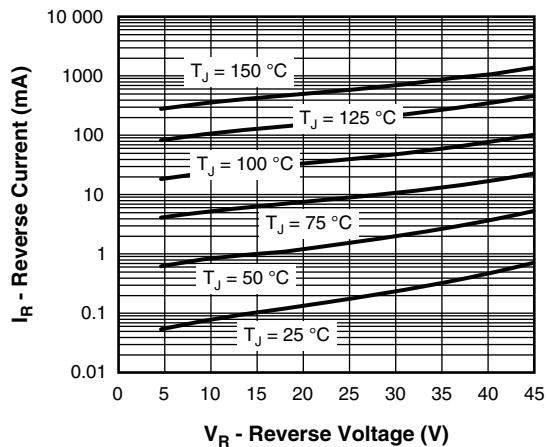

Fig. 2 - Typical Values of Reverse Current vs. Reverse Voltage

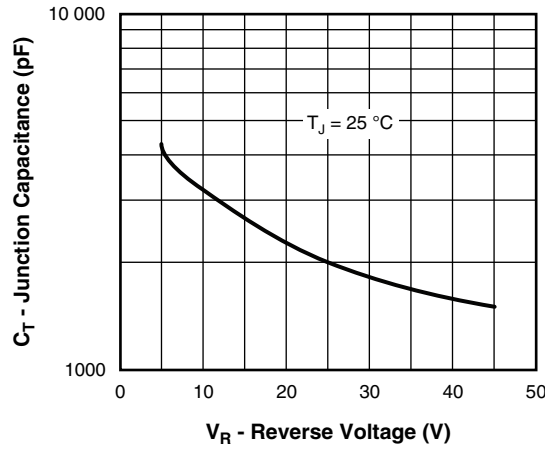

Fig. 3 - Typical Junction Capacitance vs. Reverse Voltage

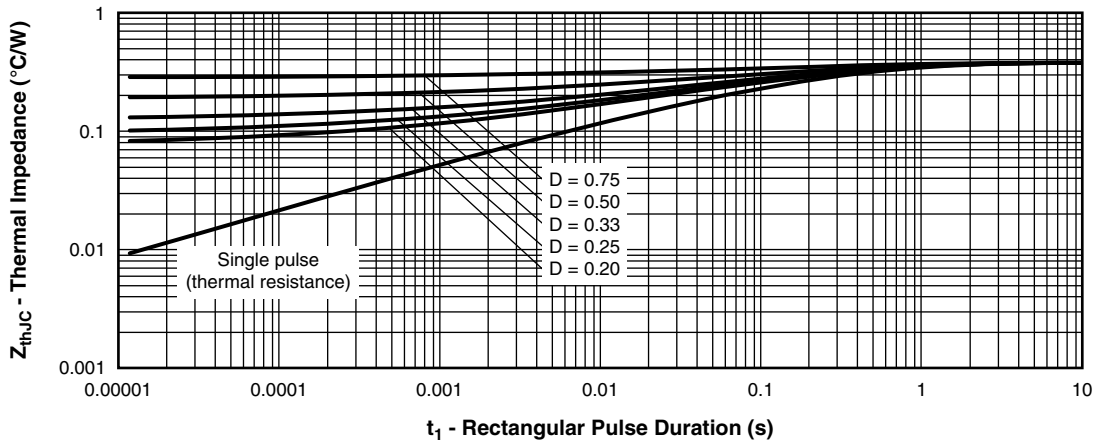

Fig. 4 - Maximum Thermal Impedance Z_{thJC} Characteristics

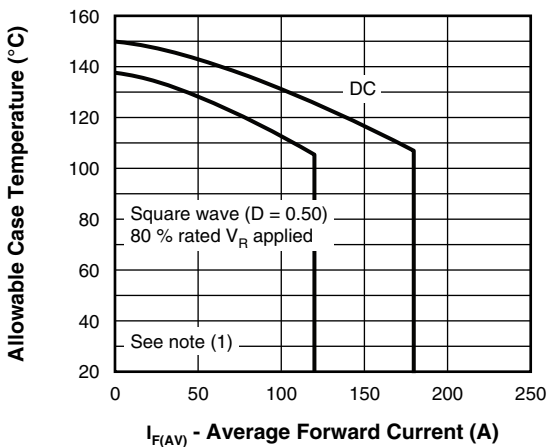

Fig. 5 - Maximum Allowable Case Temperature vs. Average Forward Current

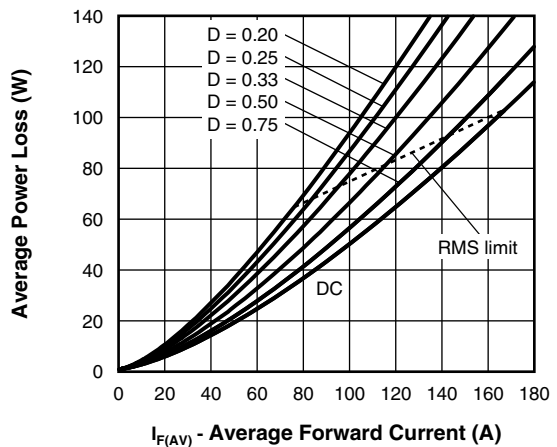

Fig. 6 - Forward Power Loss Characteristics

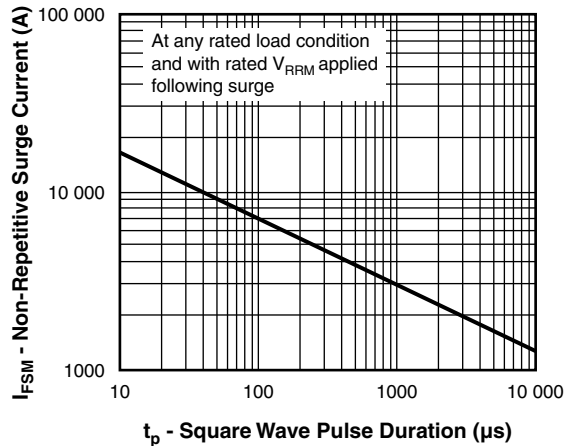

Fig. 7 - Maximum Non-Repetitive Surge Current

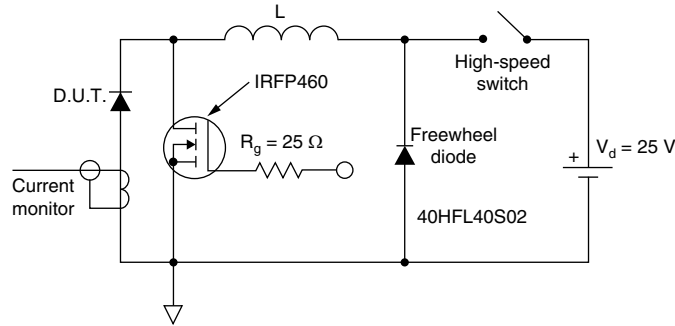

Fig. 8 - Unclamped Inductive Test Circuit

Note

- (1) Formula used: $T_C = T_J - (P_d + P_{d_{REV}}) \times R_{thJC}$;
- P_d = forward power loss = $I_{F(AV)} \times V_{FM}$ at $(I_{F(AV)}/D)$ (see fig. 6);
- $P_{d_{REV}}$ = inverse power loss = $V_{R1} \times I_R (1 - D)$; I_R at V_{R1} = rated V_R

ORDERING INFORMATION TABLE

Device code	VS-	12	0	N	Q	045	PbF		
	①	②	③	④	⑤	⑥	⑦		
	1	-	Vishay Semiconductors product	2	-	Average current rating (x 10)	3	-	Product silicon identification
	4	-	N = not isolated	5	-	Q = Schottky rectifier diode	6	-	Voltage rating (045 = 45 V)
	7	-	Lead (Pb)-free						

LINKS TO RELATED DOCUMENTS	
Dimensions	www.vishay.com/doc?95020

D-67 HALF-PAK

DIMENSIONS in millimeters (inches)

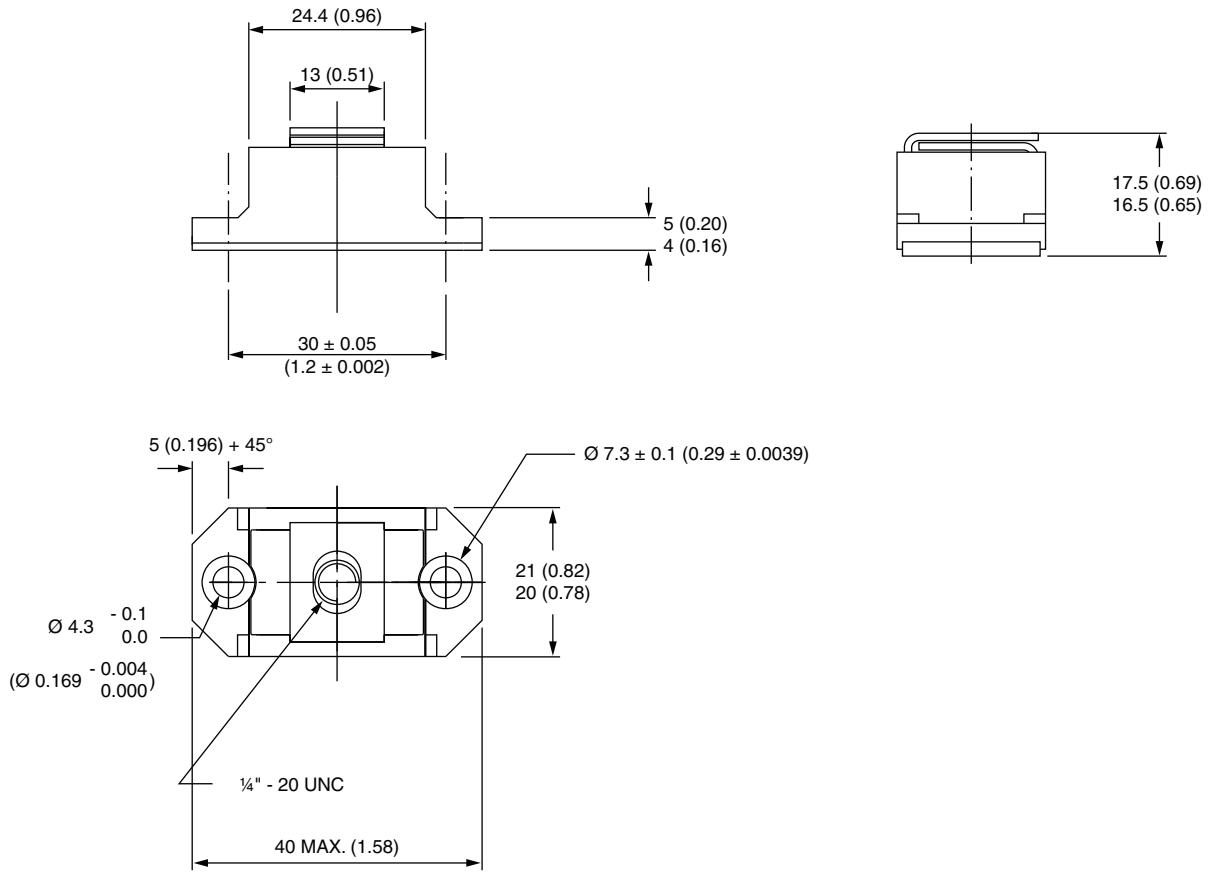



Disclaimer

ALL PRODUCT, PRODUCT SPECIFICATIONS AND DATA ARE SUBJECT TO CHANGE WITHOUT NOTICE TO IMPROVE RELIABILITY, FUNCTION OR DESIGN OR OTHERWISE.

Vishay Intertechnology, Inc., its affiliates, agents, and employees, and all persons acting on its or their behalf (collectively, "Vishay"), disclaim any and all liability for any errors, inaccuracies or incompleteness contained in any datasheet or in any other disclosure relating to any product.

Vishay makes no warranty, representation or guarantee regarding the suitability of the products for any particular purpose or the continuing production of any product. To the maximum extent permitted by applicable law, Vishay disclaims (i) any and all liability arising out of the application or use of any product, (ii) any and all liability, including without limitation special, consequential or incidental damages, and (iii) any and all implied warranties, including warranties of fitness for particular purpose, non-infringement and merchantability.

Statements regarding the suitability of products for certain types of applications are based on Vishay's knowledge of typical requirements that are often placed on Vishay products in generic applications. Such statements are not binding statements about the suitability of products for a particular application. It is the customer's responsibility to validate that a particular product with the properties described in the product specification is suitable for use in a particular application. Parameters provided in datasheets and / or specifications may vary in different applications and performance may vary over time. All operating parameters, including typical parameters, must be validated for each customer application by the customer's technical experts. Product specifications do not expand or otherwise modify Vishay's terms and conditions of purchase, including but not limited to the warranty expressed therein.

Except as expressly indicated in writing, Vishay products are not designed for use in medical, life-saving, or life-sustaining applications or for any other application in which the failure of the Vishay product could result in personal injury or death. Customers using or selling Vishay products not expressly indicated for use in such applications do so at their own risk. Please contact authorized Vishay personnel to obtain written terms and conditions regarding products designed for such applications.

No license, express or implied, by estoppel or otherwise, to any intellectual property rights is granted by this document or by any conduct of Vishay. Product names and markings noted herein may be trademarks of their respective owners.