

## 2835A03-XXS05-2P-F9-LX Datasheet

This 2835 LED Light Source is a high performance energy efficient device which can handle high thermal and high driving current. The small package outline and high intensity make it an ideal choice for LED panel light, LED bulb light, LED tube light, backlighting and etc.

The White Power LED is available in the range of color temperature from 2600K to 7000K.

This part has a foot print that is compatible to most of the same size LED in the market today.

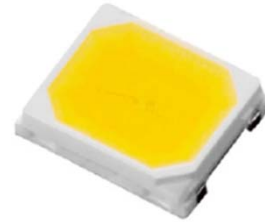

### FEATURES

---

- Available in Cool White, Neutral White and Warm White color
- ANSI-compatible chromaticity bins
- High luminous Intensity and high efficiency
- Compatible with reflow soldering process
- Low thermal resistance
- Long operation life
- Wide viewing angle at 120°
- Silicone encapsulation
- Environmental friendly, RoHS compliance

### APPLICATIONS

---

- Flat panel light
- LED tube light
- LED bulb light
- Signage and channel letter
- Reading lamp
- Decorating and entertainment lighting
- Architectural lighting

Note: The information in this document is subject to change without notice.

PACKAGE DIMENSIONS

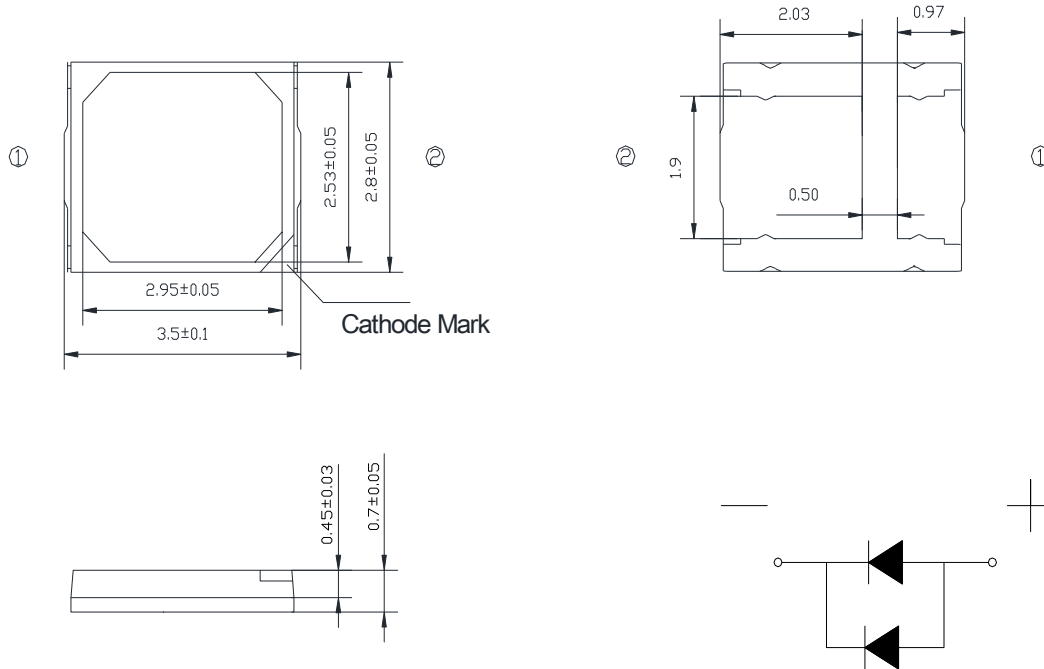

Recommended Solder Pad Design

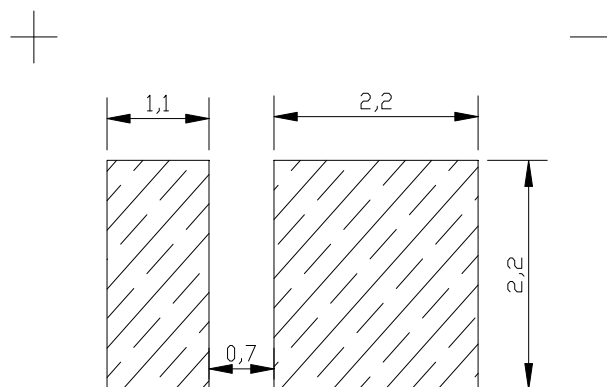

Notes:

1. All dimensions in millimeters.
2. Thickness tolerance of copper plate is  $\pm 0.02$ mm.
3. Thickness tolerance of product is  $\pm 0.05$ mm.
4. Tolerance is  $\pm 0.1$ mm unless otherwise noted.

**ABSOLUTE MAXIMUM RATINGS**

Item	Symbol	Absolute Maximum Rating	Unit
Forward current	$I_F$	250	mA
Peak Forward Current <sup>[1]</sup>	$I_{FP}$	350	mA
Reverse Voltage	$V_R$	5	V
Power Dissipation	$P_d$	500	mW
Operating Temperature	$T_{opr}$	-40~+85	°C
Storage Temperature	$T_{stg}$	-40~+100	°C
Soldering Temperature	$T_{sld}$	Reflow Soldering: 260°C for 10 seconds	
LED Junction Temperature	$T_j$	125	°C

Note:

$I_{FP}$  Conditions: Pulse Width  $\leq$  10msec. and Duty  $\leq$  1/10.

**CHARACTERISTICS (T<sub>j</sub>=25°C)**

Parameter	Symbol	Condition	Min	Typ	Max	Unit
Forward Voltage <sup>[1]</sup>	$V_F$	$I_F=150\text{mA}$	2.8	--	3.0	V
Viewing Angle	$2\theta_{1/2}$	$I_F=150\text{mA}$	--	120	--	deg.
Luminous Flux	$\Phi_v$	$I_F=150\text{mA}$	50	--	65	lm
Color Rendering Index	CRI	$I_F=150\text{mA}$	90	--	--	--
Color Temperature	CCT	$I_F=150\text{mA}$	2600	--	7000	K
Thermal Resistance (Junction to Solder Point)	$R_{th-js}$	$I_F=150\text{mA}$	--	10	--	°C/W

Notes:

- Luminous flux is measured with an accuracy of  $\pm 10\%$ .
- Chromaticity coordinate bins are measured with an accuracy of  $\pm 0.01$ .
- CRI is measured with an accuracy of  $\pm 2$  ;
- Some color and CRI bins may have limited availability, please contact us before ordering.
- All measurements were made under the standardized environment of Shineon

RELATIVE SPECTRAL POWER DISTRIBUTION ( $T_j=25^\circ\text{C}$ )

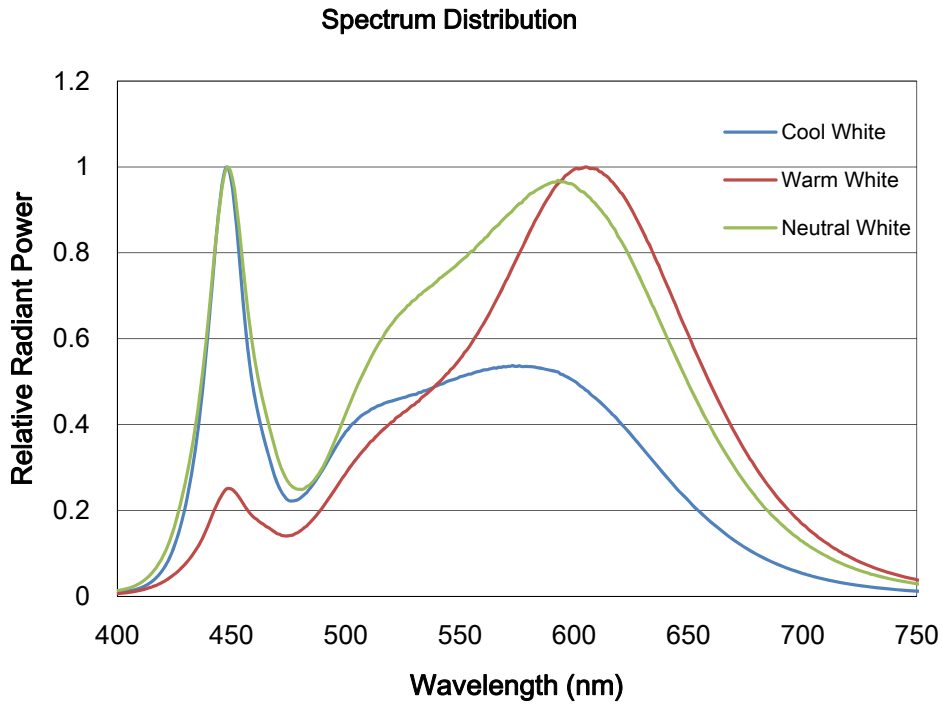

TYPICAL SPATIAL DISTRIBUTION

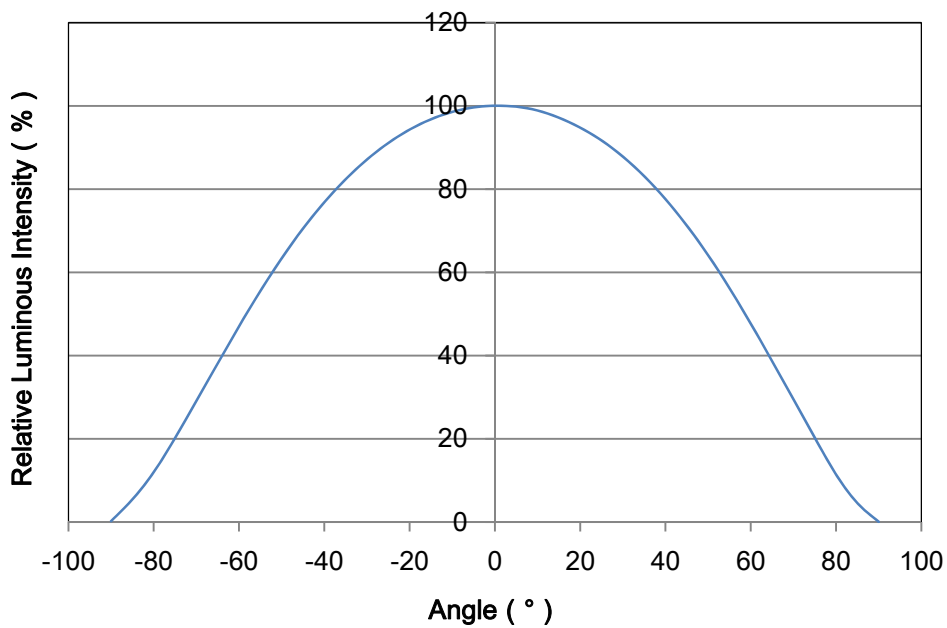

RELATIVE LUMINOUS FLUX VS. CURRENT ( $T_j=25^{\circ}\text{C}$ )

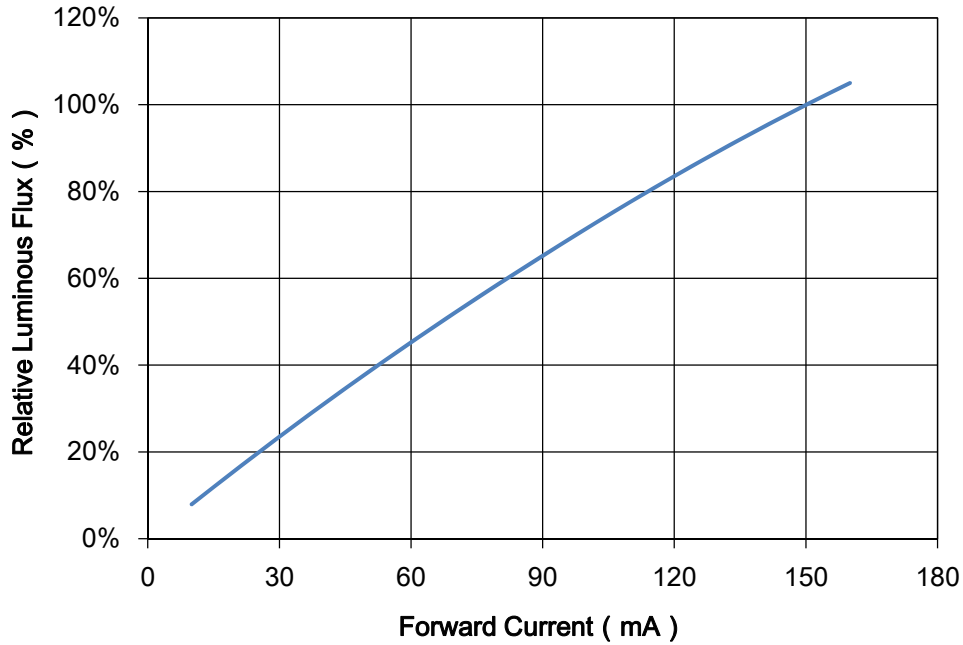

ELECTRICAL CHARACTERISTICS ( $T_j=25^{\circ}\text{C}$ )

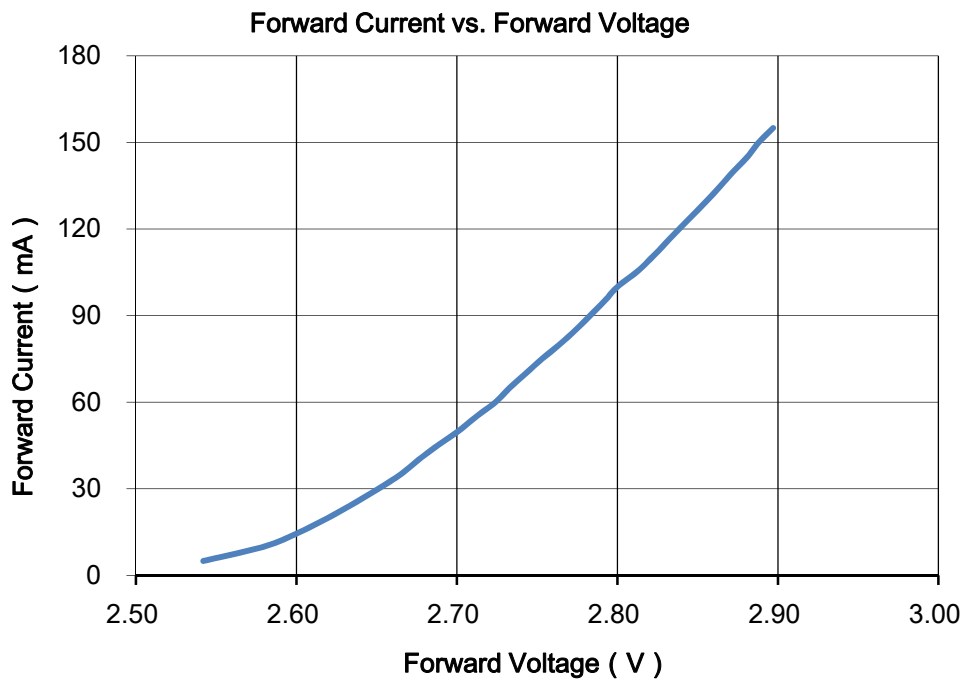

MAXIMUM CURRENT VS. AMBIENT TEMPERATURE

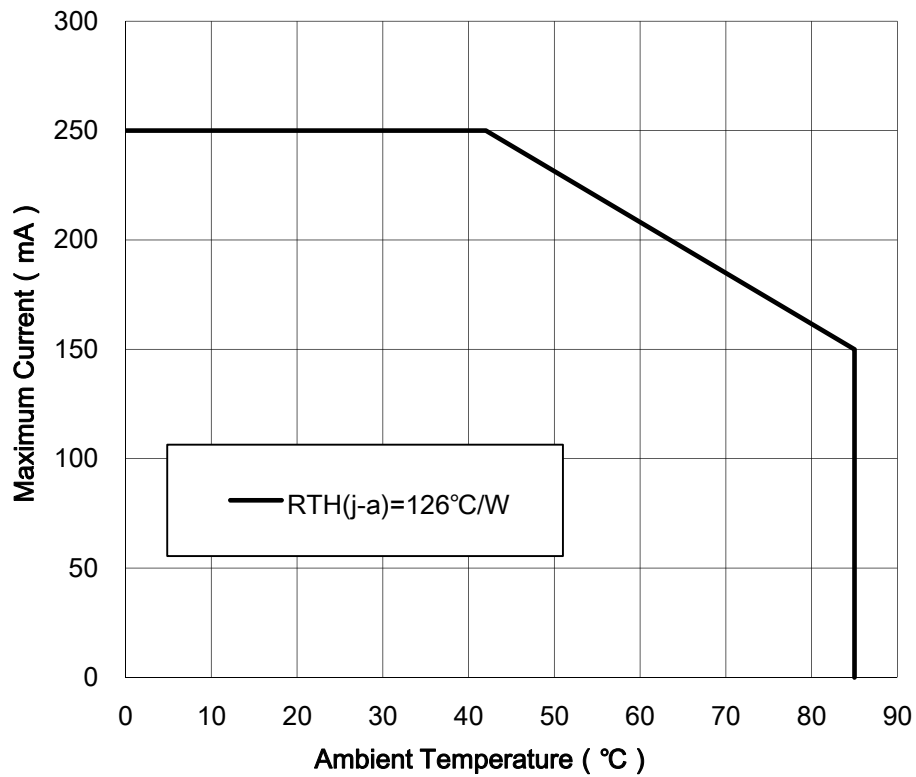

RELATIVE RADIANT FLUX VS. JUNCTION TEMPERATURE

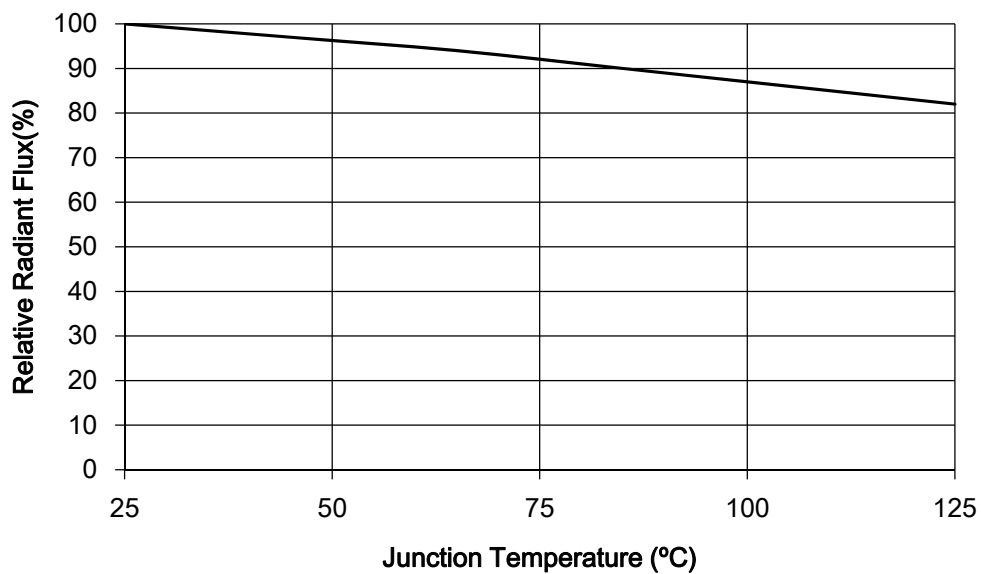

**SORTING RANKS**
**(1) Luminous Flux (Tj=25°C)**

Part Number	Condition	Rank	Unit
2835A03-27S05-2P-F9-LX	150mA	P0	lm
		50-55	
2835A03-30S05-2P-F9-LX		P1	
		55-60	
2835A03-40S05-2P-F9-LX		P2	
		60-65	
2835A03-50S05-2P-F9-LX		P2	
		60-65	
2835A03-57S05-2P-F9-LX		P2	
		60-65	
2835A03-65S05-2P-F9-LX	P2		
	60-65		

**(2) Forward Voltage (Tj=25°C)**

Rank	Condition	Min.	Max.	Unit
A8	150mA	2.8	2.9	V
A9		2.9	3.0	

**Notes:**

1. 10% tolerance for luminous intensity may be caused by measurement inaccuracy.
2. Measurement Uncertainty of the Forward Voltage :  $\pm 0.05V$

(3) Chromaticity Bins

Part Number	2835A03-27S05-2P-F9-LX			CCT	2700K
Bin Code	Color Coordinates(x,y)				
A27-5	x	y	a	b	Theta°
		0.4578	0.4101	0.01350	0.0070

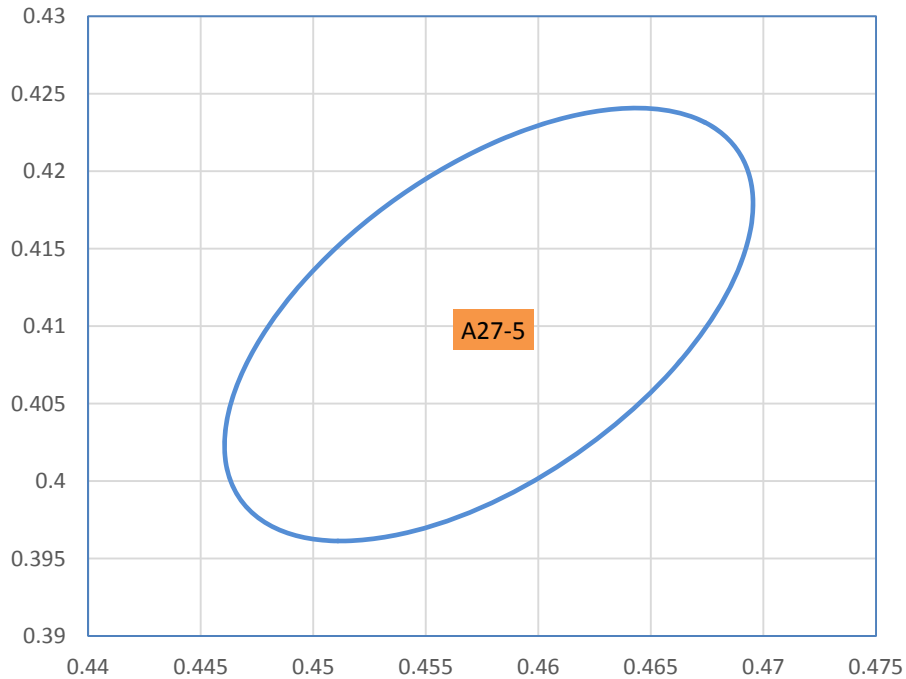



Part Number	2835A03-30S05-2P-F9-LX			CCT	3000K
Bin Code	Color Coordinates(x,y)				
A30-5	x	y	a	b	Theta°
	0.4338	0.4030	0.0139	0.0068	53.2200

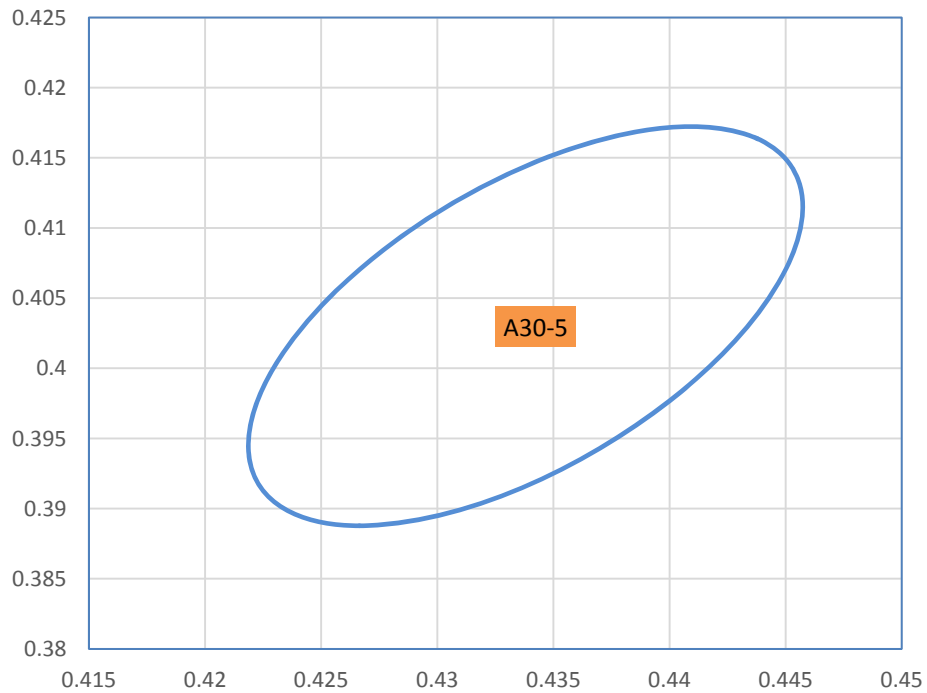

Part Number	2835A03-40S05-2P-F9-LX			CCT	4000K
Bin Code	Color Coordinates(x,y)				
A40-5	x	y	a	b	Theta°
	0.3818	0.3797	0.01565	0.0067	53.7200

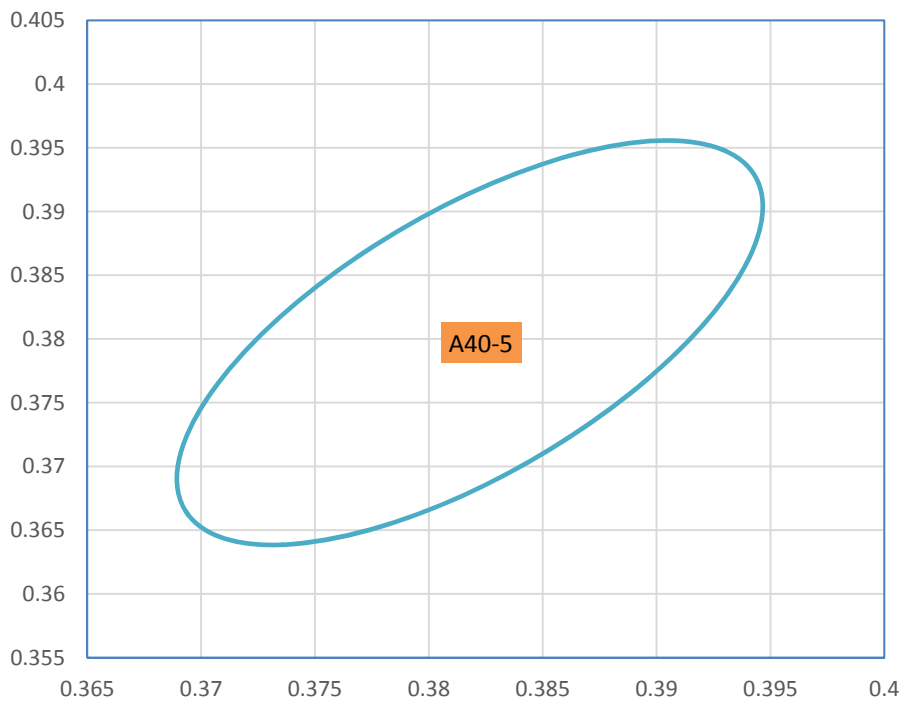

Part Number	2835A03-50S05-2P-F9-LX			CCT	5000K
Bin Code	Color Coordinates(x,y)				
A50-5	x	y	a	b	Theta°
	0.3447	0.3553	0.0137	0.0059	59.6200

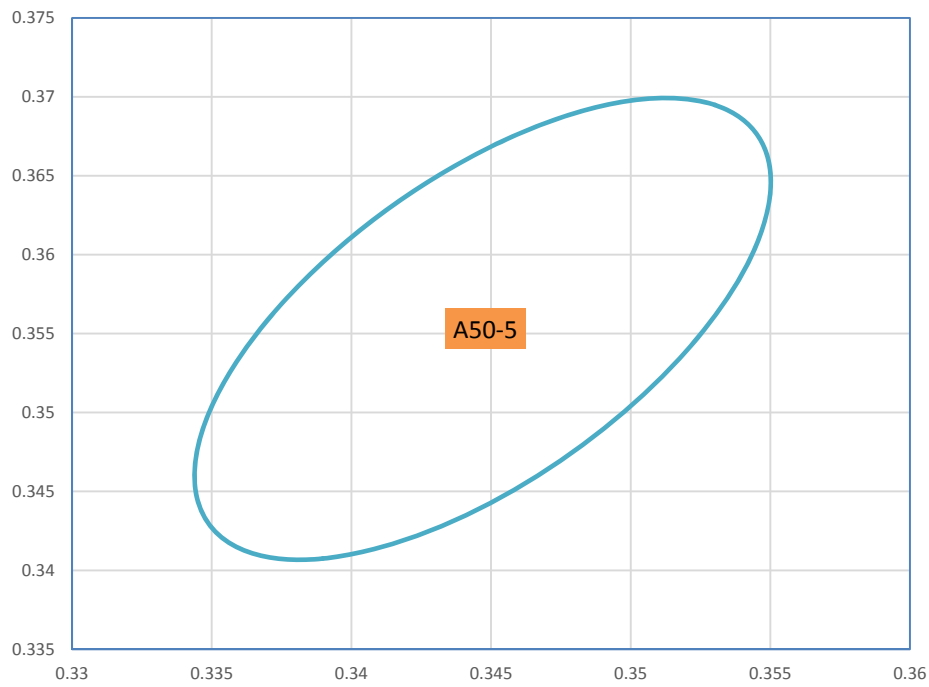

Part Number	2835A03-57S05-2P-F9-LX			CCT	5700K
Bin Code	Color Coordinates(x,y)				
A57-5	x	y	a	b	Theta°
	0.3287	0.3417	0.01243	0.00533	59.0900

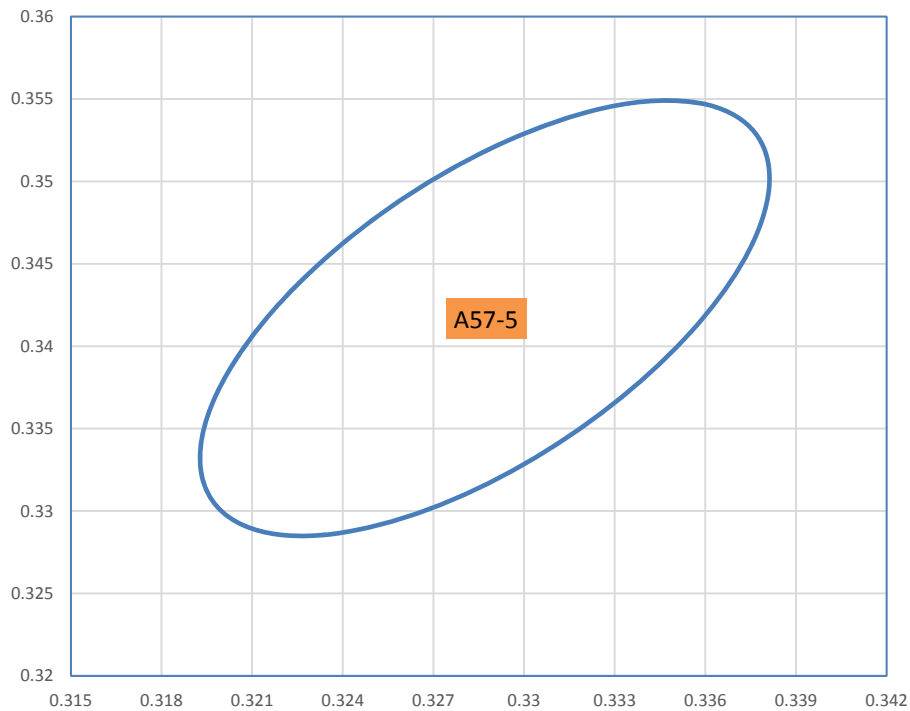

<b>Part Number</b>	2835A03-65S05-2P-F9-LX			<b>CCT</b>	6500K
<b>Bin Code</b>	Color Coordinates(x,y)				
<b>A65-5</b>	<b>x</b>	<b>y</b>	<b>a</b>	<b>b</b>	<b>Theta°</b>
	0.3123	0.3282	0.01115	0.00475	58.5700

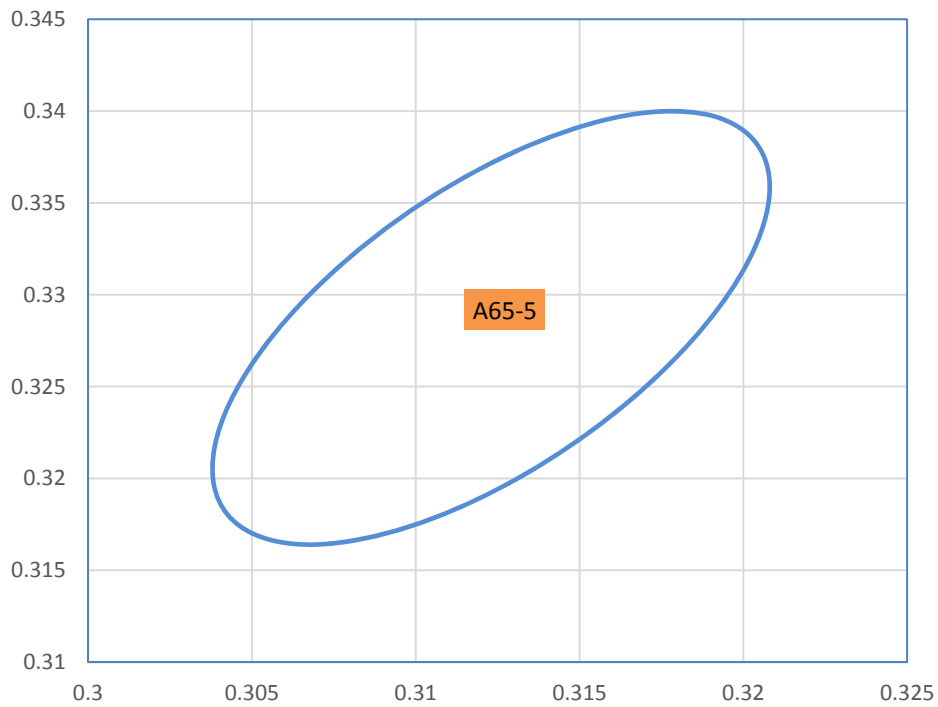

## REFLOW SOLDERING CHARACTERISTICS

### For Reflow Process:

Preheating : 140°C~160°C±5°C, within 2 minutes.

Operation heating : 260°C(Max.) within 10 seconds.(Max)

Gradual Cooling (Avoid quenching).

Lead solder		Lead-free solder	
Pre-heat	120-150°C	Pre-heat	150-200°C
Pre-heat time	120 sec.Max.	Pre-heat time	120 sec.Max.
Peak Temperature	240°C Max.	Peak Temperature	260°C Max.
Soldering time condition	10 sec.Max.	Soldering time condition	10 sec.Max.

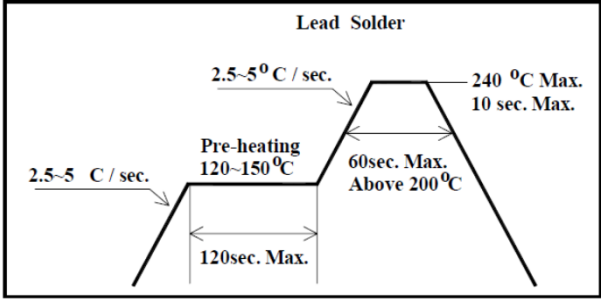
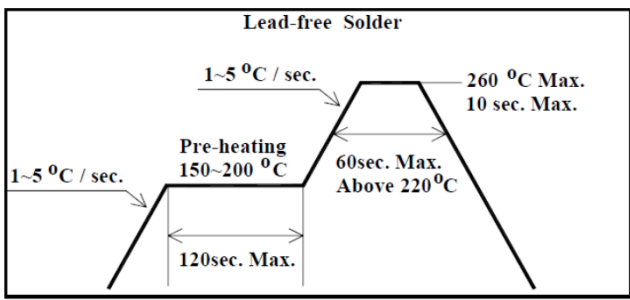

 <p><b>Lead Solder</b></p> <p>2.5~5 °C / sec. (initial ramp)</p> <p>Pre-heating 120~150°C (120sec. Max.)</p> <p>2.5~5 °C / sec. (second ramp)</p> <p>240 °C Max. (10 sec. Max.)</p> <p>60sec. Max. Above 200°C</p>	 <p><b>Lead-free Solder</b></p> <p>1~5 °C / sec. (initial ramp)</p> <p>Pre-heating 150~200 °C (120sec. Max.)</p> <p>1~5 °C / sec. (second ramp)</p> <p>260 °C Max. (10 sec. Max.)</p> <p>60sec. Max. Above 220°C</p>
--	---

### Notes:

The encapsulated material of the LEDs is silicone . Therefore the LEDs have a soft surface on the top of package. The pressure to the top surface will be influence to the reliability of the LEDs. Precautions should be taken to avoid the strong pressure on the encapsulated part. So when using the picking up nozzle, the pressure on the silicone resin should be proper.

TAPE AND REEL

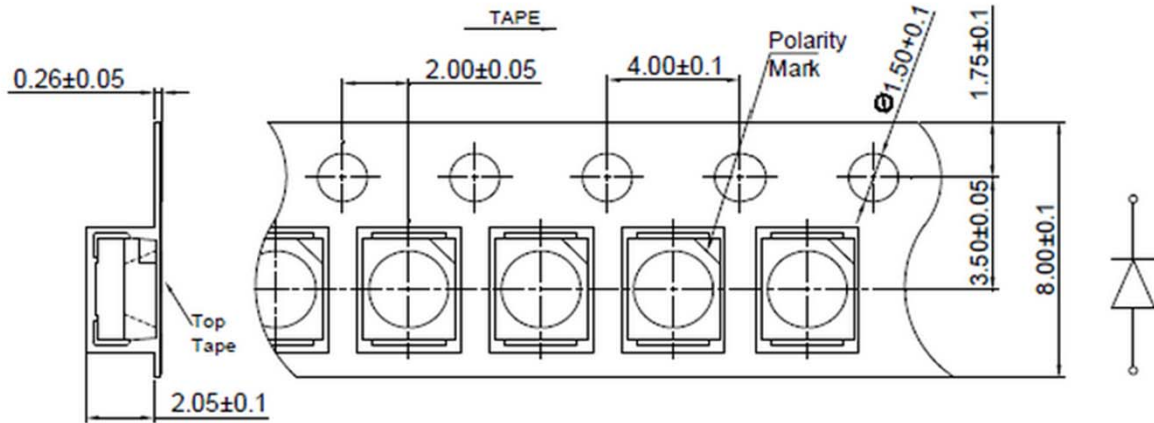

Note: The tolerances unless mentioned is ±0.1mm, Unit=mm

Notes:

- (1) Quantity : 4,000pcs/Reel
- (2) Cumulative Tolerance : Cumulative Tolerance/10 pitches to be ±0.2mm
- (3) Adhesion Strength of Cover Tape : Adhesion strength to be 0.1-0.7N when the cover tape is turned off from the carrier tape at the angle of 10° to the carrier tape
- (4) Package : P/N, Manufacturing data Code No. and quantity to be indicated on a damp proof Package.

**PACKAGING**

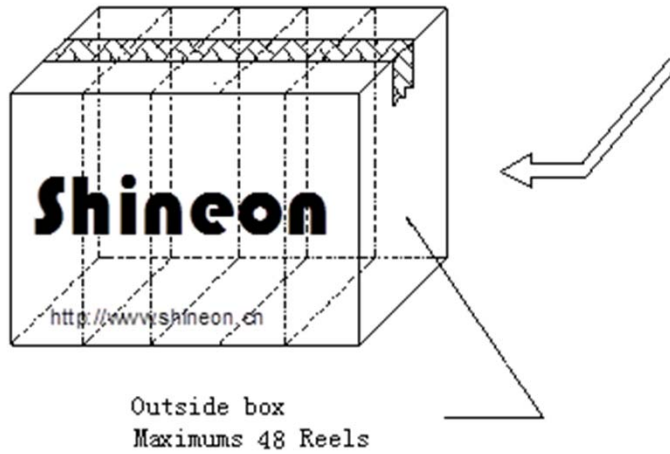
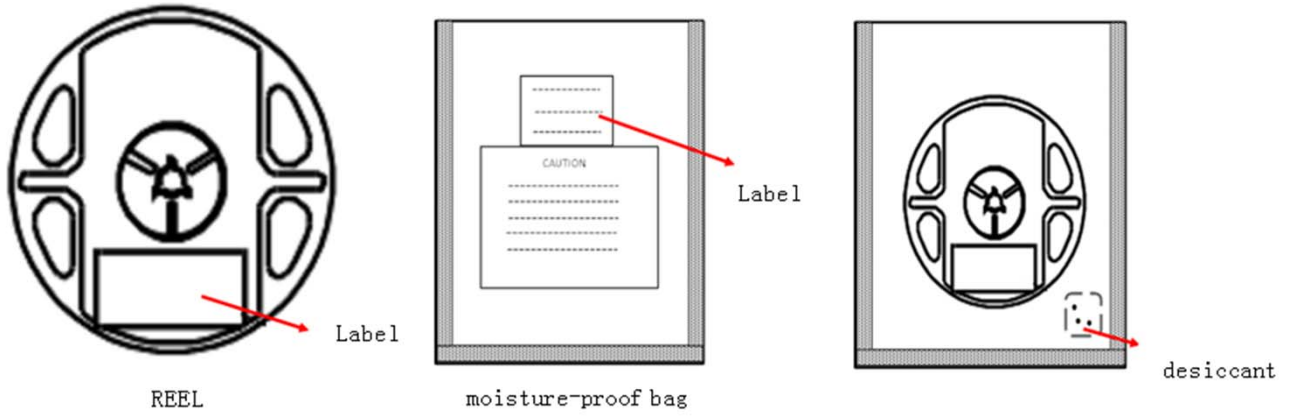



Reliability Test Items

Test Items	Test Duration	Number of Damaged
Steady State Operating Life of High Temperature (HTOL) $T_s=85^{\circ}\text{C}$ , $I_F=\text{Max}$	1000hrs	0/20
Steady State Operating Life of Low Temperature (LTOL) $T_a=-40^{\circ}\text{C}$ , $I_F=\text{Max}$	1000hrs	0/20
High Temperature Storage (HTS) $100^{\circ}\text{C}$	1000hrs	0/20
Low Temperature Storage (LTS) $-40^{\circ}\text{C}$	1000hrs	0/20
Thermal Shock (TS) $-45^{\circ}\text{C}\sim 125^{\circ}\text{C}$ 30min dwell 20sec transfer	200cycles	0/20
Solder Resistance (SR) $265^{\circ}\text{C}$ , 3X MSL	5sec	0/20
Solder Ability (SA) $245^{\circ}\text{C}$ 5sec, 95% coverage	5sec	0/11

Item	Symbol	Test Condition	Criteria for Judgment	
			Min.	Max.
Forward	$V_f$	$I_F=\text{Typical Current}$		U.S.L x1.1
Luminous Flux	$I_m$	$I_F=\text{Typical Current}$	L.S.L x0.7	
CCX&CCY	x,y	$I_F=\text{Typical Current}$		Shift<0.02

## PRECAUTION FOR USE

---

- (1) This device should not be used in any type of fluid such as water, oil, organic solvent, etc. When washing is required, IPA should be used.
- (2) When the LEDs are illuminating, operating current should be decided after considering the ambient maximum temperature.
- (3) LEDs must be stored to maintain a clean atmosphere. If the LEDs are stored for 3 months or more after being shipped from ShineOn, a sealed container with a nitrogen atmosphere should be used for storage.
- (4) The LEDs must be used within seven days after opening the moisture proof packing. Repack unused Products with anti-moisture packing, fold to close any opening and then store in a dry place.
- (5) The appearance and specifications of the product may be modified for improvement without notice.
- (6) This LED is sensitive to the static electricity and surge. It is recommended to use a wrist Band or anti-electrostatic glove when handling the LEDs.
- (7) On manual soldering, a solder tip must be needed as grounded for usage. If over voltage which exceeds the absolute maximum rating is applied to LEDs, it will cause damage LEDs and result in destruction. Damaged LEDs will show some unusual characteristics such as leak current remarkably increase ,turn-on voltage becomes lower and the LEDs get unlighted at low current.