



## TITLE : MV270QUM-N50

### Product Specification For LGE

Ver. 0

Customer : LGE

APPROVED BY	
DATE	

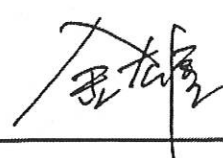
 2021.1.12		 2021.1.12
CONFIRMED BY MNT SBU	CONFIRMED BY QA	CONFIRMED BY R&D

FUZHOU BOE OPTOELECTRONICS CO., LTD

SPEC. NUMBE S8-64-8D-166	PRODUCT GROUP TFT-LCD	Ver. 0	ISSUE DATE 2021.01.11	PAGE 1 OF 31
-----------------------------	--------------------------	--------	--------------------------	-----------------

**REVISION HISTORY**

( ) Preliminary specification

(●) Final specification

Revision No.	Page	Description of changes	Date	Prepared
Ver. P0	-	Initial Release	2020.07.16	You Li
Ver. P1	P4/P7/P8/ P9/P22	<ol style="list-style-type: none"> <li>1. Update Features</li> <li>2. Update Electrical specifications</li> <li>3. Update LED Backlight Unit</li> <li>4. Update Optical specifications</li> <li>5. Update label specifications</li> </ol>	2020.10.22	You Li
Ver. P2	P5/P9/P10/P 12/P16/P19	<ol style="list-style-type: none"> <li>1. Update Pixel Pitch</li> <li>2. Update Note7</li> <li>3. Update Backlight Unit</li> <li>4. Update LED Light Bar</li> <li>5. Update Signal Timing</li> </ol>	2020.11.03	You Li
Ver. 0	-	Final specification	2021.01.11	You Li

## Contents

<b>No.</b>	<b>Item</b>	<b>Page</b>
1.0	General Description	4
2.0	Absolute Maximum Ratings	6
3.0	Electrical Specifications	7
4.0	Optical Specifications	10
5.0	Interface Connection	12
6.0	Signal Timing Specifications	17
7.0	Input Signals, Display Colors & Gray Scale of Colors	18
8.0	Power Sequence	19
9.0	Mechanical Characteristics	20
10.0	Reliability Test	21
11.0	Handling& Cautions	22
12.0	Product Serial Number	23
13.0	Packing	24
14.0	Appendix	26
15.0	International Standards	31

## 1.0 GENERAL DESCRIPTION

### 1.1 Introduction

MV270QUM-N50 is a color active matrix TFT LCD module using amorphous silicon TFT's (Thin Film Transistors) as an active switching devices. This module has a 27.0 inch diagonally measured active area with UHD resolutions (3840 horizontal by 2160 vertical pixel array). Each pixel is divided into RED, GREEN, BLUE dots which are arranged in vertical stripe and this module can display 1.07B colors. The TFT-LCD panel used for this module is adapted for a low reflectin and higher color type.

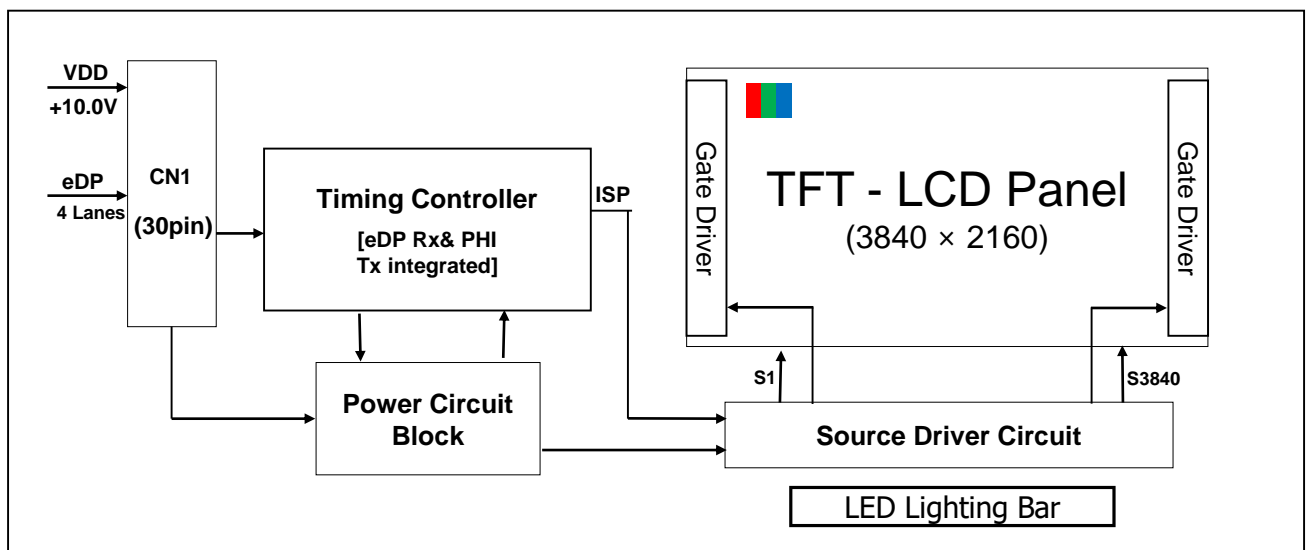

### 1.2 Features

- 4 lane eDP Interface with 5.4Gbps Link Rates
- 10-bit (8bit+FRC) color depth, display 1.07Bcolors
- Compatible with DCI P3 95%typ. (92%min.)&sRGB 100%typ.(97%min.) @CIE1976.
- High luminance and contrast ratio, low reflection and wide viewing angle
- DE (Data Enable) only
- RoHS/Halogen Free
- ES 8.0 compliant
- Gamma Correction
- Reverse type
- HADs Display Mode

### 1.3 Application

- Desktop Type of PC & Workstation Use
- Slim-Size Display for Stand-alone Monitor
- Display Terminals for Control System
- Monitors for Process Controller

### 1.4 General Specification

The followings are general specifications at the model MV270QUM-N50.

<Table 1. General Specifications>

Parameter	Specification	Unit	Remarks
Active area	596.736(H)*335.664(V)	mm	
Number of pixels	3840(H)×2160(V)	pixels	
Pixel pitch	0.1554(H) × 0.1554(V)	mm	
Pixel arrangement	RGB Vertical stripe		
Display colors	1.07B	colors	8bit+FRC
Display mode	Normally Black		
Dimensional outline	609.4(H) × 355.6(V) × 13.3(D) typ.	mm	Detail refer to drawing
Weight	2450(Typ.) / 2600(Max.)	g	
AA~Outline (L/R/U/D)	6.032/6.032/5.968/13.668	mm	
Surface Treatment	AG25, 3H		
Back-light	Down side, 1-LED Lighting Bar type		

### 2.0 ABSOLUTE MAXIMUM RATINGS

The followings are maximum values which, if exceed, may cause faulty operation or damage to the unit. The operational and non-operational maximum voltage and current values are listed in Table 2.

< Table 2. Absolute Maximum Ratings >

[VSS=GND=0V]

Parameter	Symbol	Min.	Max.	Unit	Remarks
Power Supply Voltage	V <sub>DD</sub>	-0.3	12	V	Ta = 25 °C
Logic Supply Voltage	V <sub>IN</sub>	VSS-0.3	V <sub>DD</sub> +0.3	V	
Operating Temperature	T <sub>OP</sub>	0	+50	°C	1)
Storage Temperature	T <sub>ST</sub>	-20	+60	°C	1)
LCM Surface Temperature (Operation)	T <sub>surface</sub>	0	+48	°C	2)

Note : 1) Temperature and relative humidity range are shown in the figure below.

Wet bulb temperature should be 39 °C max. and no condensation of water.

2) Panel Surface Temperature should be Min. 0°C and Max. +48°C under the

VDD = 12.0V, Frame rate = 60Hz, 25°C ambient Temp. no humidity control and LED string current is typical value.

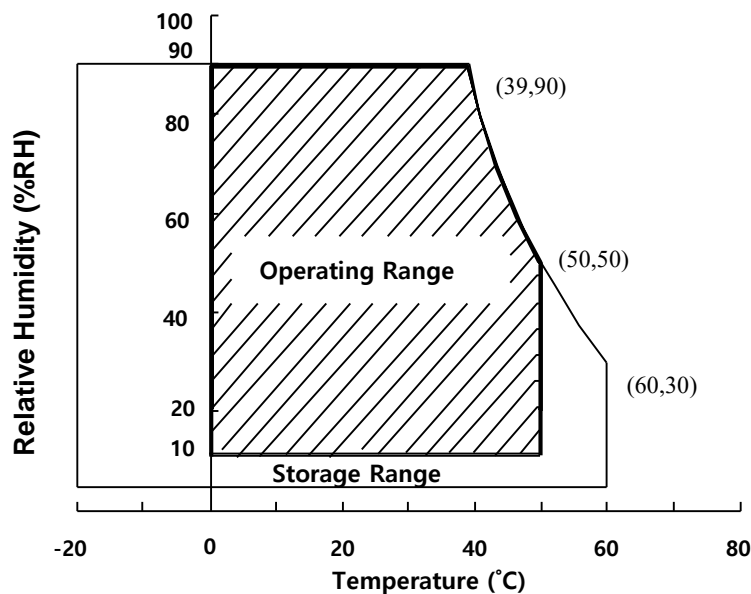

### 3.0 ELECTRICAL SPECIFICATIONS

#### 3.1 Electrical Specifications

< Table 3. Electrical specifications >

[Ta =25±2 °C]

Parameter.		Min.	Typ.	Max.	Unit	Remarks
Power Supply Voltage	V <sub>DD</sub>	9.5	10.0	10.5	V	Note1
Power Supply Current	I <sub>DD</sub>	-	900	1300	mA	
In-Rush Current	I <sub>RUSH</sub>	-	2.0	3.0	A	Note 2
Permissible Input Ripple Voltage	V <sub>RF</sub>	-	-	300	mV	Note1,3
Main link swing voltage	V <sub>ID</sub>	100	-	1320	mV	
Differential input common mode voltage	V <sub>cm</sub>	0	-	2		
Power Consumption	P <sub>D</sub>	-	9.0	13	W	
	P <sub>BL</sub>	-	23.5	24.3	W	Note 4
	P <sub>total</sub>	-	32.5	37.3	W	

Notes : 1. The supply voltage is measured and specified at the interface connector of LCM.

The current draw and power consumption specified is for VDD=10.0V, Frame rate=60Hz

Clock frequency = 533MHz. Test Pattern of power supply current

a) Typ : Color Bar

b) Max :Vertical sub line 255



(a)

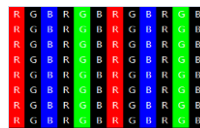

(b)

2. Duration of rush current is about 2 ms and rising time of VDD is 520 μs ± 20 %

3. Ripple Voltage should be covered by Input voltage Spec.

4. Calculated value for reference (Input pins\*VPIN ×IPIN) excluding inverter loss.

### 3.2 Backlight Unit

< Table 4. LED Backlight Unit >

Parameter		Min.	Typ.	Max.	Unit	Remarks
LED Light Bar Input Voltage Per Input Pin	VPIN	35	42	43.4	V	Duty 100%
LED Light Bar Input Current Per Input Pin	IPIN	-	70	-	mA	Note1,2
LED Power Consumption	P <sub>BL</sub>	19.6	23.5	24.3	W	Note 3
LED Life-Time	-	30,000	-	-	Hrs	Note 4
Silicon Property life time	-	30,000	-	-	Hrs	Note 5

LED bar consists of 112 LED packages, 8 strings (parallel) \* 14 packages (serial)

Note1: There are one light bar, and the specified current is input LED chip 100% duty current

Note2: The sense current of each input pin is 70mA

Note3:  $P_{BL} = 8 \text{ Input pins} \times V_{PIN} \times I_{PIN}$

Note4: The lifetime is determined as the time at which luminance of LED become 50% of the initial brightness or not normal lighting at  $I_{PIN} = 70\text{mA}$  on condition of continuous operating at  $25 \pm 2 \text{ }^\circ\text{C}$

Note5: Condition:  $T_j < 85^\circ\text{C}$ ,  $T_a = 60^\circ\text{C}$ ,  $I_{pin} = 70\text{mA}$

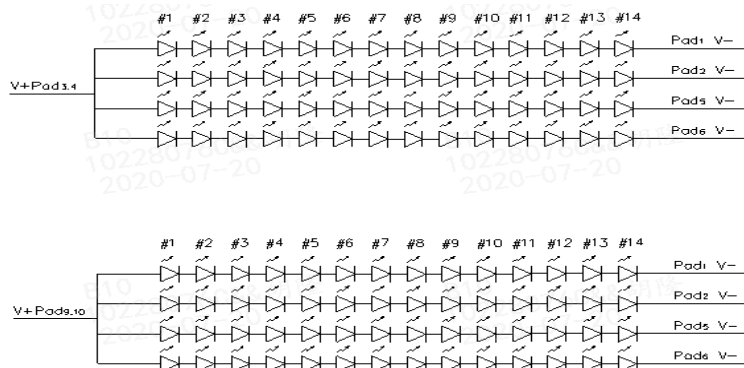



< Table 5. LED Backlight Unit @Peak Brightness>

Parameter		Min.	Typ.	Max.	Unit	Remarks
LED Light Bar Input Voltage Per Input Pin	VPIN	35	42	43.4	V	Duty 100%
LED Light Bar Input Current Per Input Pin	IPIN	-	90	-	mA	Note 6
MDL peak brightness	-	-	500	-	nit	

Note6. Long time use at peak brightness or reliability testing at peak brightness will affect product life and even cause issue.

Note7. When the sense current of each input pin is 80mA, the min brightness is 400nits.

## 4.0 OPTICAL SPECIFICATION

### 4.1 Overview

The test of Optical specifications shall be measured in a dark room (ambient luminance  $\leq 1$  lux and temperature =  $25\pm 2^\circ\text{C}$ ) with the equipment of Luminance meter system (Goniometer system and TOPCONE PR730) and test unit shall be located at an approximate distance 50cm from the LCD surface at a viewing angle of  $\theta$  and  $\Phi$  equal to  $0^\circ$ . We refer to  $\theta_{\theta=0}$  ( $=\theta_3$ ) as the 3 o'clock direction (the "right"),  $\theta_{\theta=90}$  ( $=\theta_{12}$ ) as the 12 o'clock direction ("upward"),  $\theta_{\theta=180}$  ( $=\theta_9$ ) as the 9 o'clock direction ("left") and  $\theta_{\theta=270}$  ( $=\theta_6$ ) as the 6 o'clock direction ("bottom"). While scanning  $\theta$  and/or  $\Phi$ , the center of the measuring spot on the Display surface shall stay fixed. The measurement shall be executed after 30 minutes warm-up period. VDD shall be 10.0V  $\pm 10\%$  at  $25^\circ\text{C}$ . Optimum viewing angle direction is 6 o'clock.

### 4.2 Optical Specifications

[VDD = 10.0V, Frame rate = 60Hz, Clock = 533MHz,  $I_{BL} = 70*8\text{mA}$ ,  $T_a = 25\pm 2^\circ\text{C}$ ]

Parameter		Symbol	Condition	Min.	Typ.	Max.	Unit	Remark
Viewing Angle range	Horizontal	$\Theta_3$	CR > 10	85	89	-	Deg.	Note 1
		$\Theta_9$		85	89	-	Deg.	
	Vertical	$\Theta_{12}$		85	89	-	Deg.	
		$\Theta_6$		85	89	-	Deg.	
Luminance Contrast ratio		CR		1000	1200			Note 2
Luminance of White		$Y_w$		320	400		cd/m <sup>2</sup>	Note 3
White luminance uniformity		$\Delta Y$		75	80		%	Note 4
Reproduction of color	White	$W_x$	$\Theta = 0^\circ$ (Center) Normal Viewing Angle	0.283	0.313	0.343	-	Note 5 (参考值)
		$W_y$		0.299	0.329	0.359	-	
	Red	$R_x$		0.651	0.681	0.711	-	
		$R_y$		0.286	0.316	0.346	-	
	Green	$G_x$		0.228	0.258	0.288	-	
		$G_y$		0.646	0.676	0.706	-	
	Blue	$B_x$		0.12	0.15	0.18	-	
		$B_y$		0.032	0.062	0.092	-	
Color Gamut	DCI P3		@CIE1976	92	95	-	%	Typ.
	sRGB			97	100	-		
Response Time	GTG	$T_g$		-	14	20	ms	Note 6
Gamma Scale				2.0	2.2	2.4		

**Note :**

1. Viewing angle is the angle at which the contrast ratio is greater than 10. The viewing are determined for the horizontal or 3, 9 o'clock direction and the vertical or 6, 12 o'clock direction with respect to the optical axis which is normal to the LCD surface.
2. Contrast measurements shall be made at viewing angle of  $\theta = 0^\circ$  and at the center of the LCD surface. Luminance shall be measured with all pixels in the view field set first to white, then to the dark (black) state. (See FIGURE 1 shown in Appendix) Luminance Contrast Ratio (CR) is defined mathematically.

$$CR = \frac{\text{Luminance when displaying a white raster}}{\text{Luminance when displaying a black raster}}$$

3. Center Luminance of white is defined as the LCD surface. Luminance shall be measured with all pixels in the view field set first to white. This measurement shall be taken at the locations shown in FIGURE 2 for a total of the measurements per display. When LCD module brightness is 400-420nits, L0 brightness is less than 0.4nits.
4. The White luminance uniformity on LCD surface is then expressed as :
 
$$\Delta Y = (\text{Minimum Luminance of 9points} / \text{Maximum Luminance of 9points}) * 100$$
 (See FIGURE 2 shown in Appendix).
5. The color chromaticity coordinates specified in Table 4. shall be calculated from the spectral data measured with all pixels first in red, green, blue and white. Measurements shall be made at the center of the panel.
6. Response time Tg is the average time required for display transition by switching the input signal as below table and is based on Frame rate fV =60Hz to optimize.  
Each time in below table is defined as Figure 3and shall be measured by switching the input signal for "any level of gray(bright)"and "any level of gray(dark)".

## 5.0 INTERFACE CONNECTION.

### 5.1 Electrical Interface Connection

#### 5.1.1 LED Light Bar

-LED connector: 7083K-F06N-04L manufactured by Entery.

-B/L connector : 3711K-Q06N-01R manufactured by Entery.

< Table 1. LED Light Bar >

Pin No	Symbol	Description
1	FB1	Channel1 Current Feedback
2	FB2	Channel2 Current Feedback
3	VLED	LED Power Supply
4	VLED	LED Power Supply
5	FB3	Channel3 Current Feedback
6	FB4	Channel4 Current Feedback

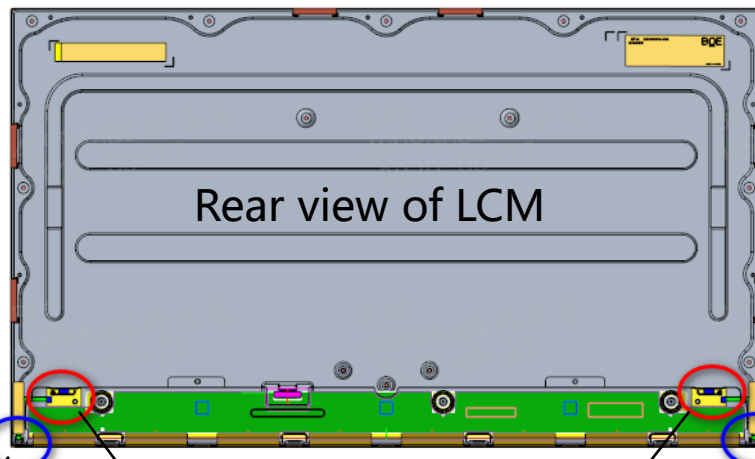

Rear view of LCM

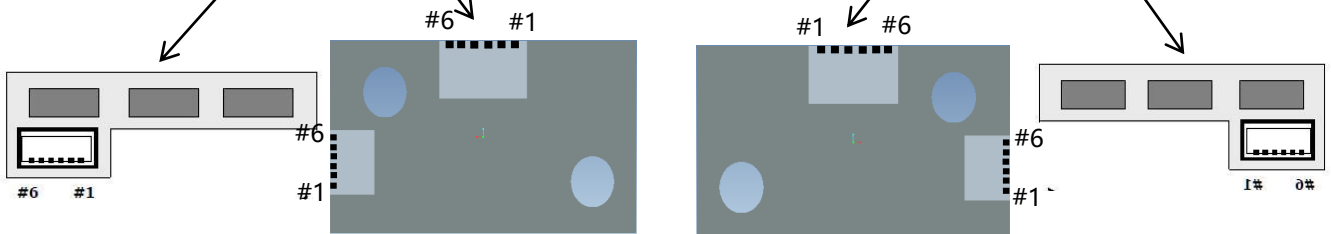

## 5.0 INTERFACE CONNECTION.

### 5.2 Electrical Interface Connection

- CN1      Module Side Connector : STM MSAK24025P30 or IPEX 20455-030E-66.

Pin No	Symbol	Function	Remark
1	VDD	Power Supply (10.0V)	
2	VDD	Power Supply (10.0V)	
3	VDD	Power Supply (10.0V)	
4	VDD	Power Supply (10.0V)	
5	VDD	Power Supply (10.0V)	
6	NC	No connection	
7	GND	Ground	
8	NC	No connection	
9	NC	No connection	
10	GND	Ground	
11	HPD	Hot Plug Detection Signal	
12	GND	Ground	
13	DAUXN	Negative Signal for Auxiliary Chanel	
14	DAUXP	Positive Signal for Auxiliary Chanel	
15	GND	Ground	
16	DRX0P	Positive Signal For eDP Lane0	
17	DRX0N	Negative Signal For eDP Lane0	
18	GND	Ground	
19	DRX1P	Positive Signal For eDP Lane1	
20	DRX1N	Negative Signal For eDP Lane1	
21	GND	Ground	
22	DRX2P	Positive Signal For eDP Lane2	
23	DRX2N	Negative Signal For eDP Lane2	
24	GND	Ground	
25	DRX3P	Positive Signal For eDP Lane3	
26	DRX3N	Negative Signal For eDP Lane3	
27	GND	Ground	
28	NC	No connection	
29	NC	No connection	
30	NC	No connection	Reserved for BIST Function

### 5.3.eDP Interface

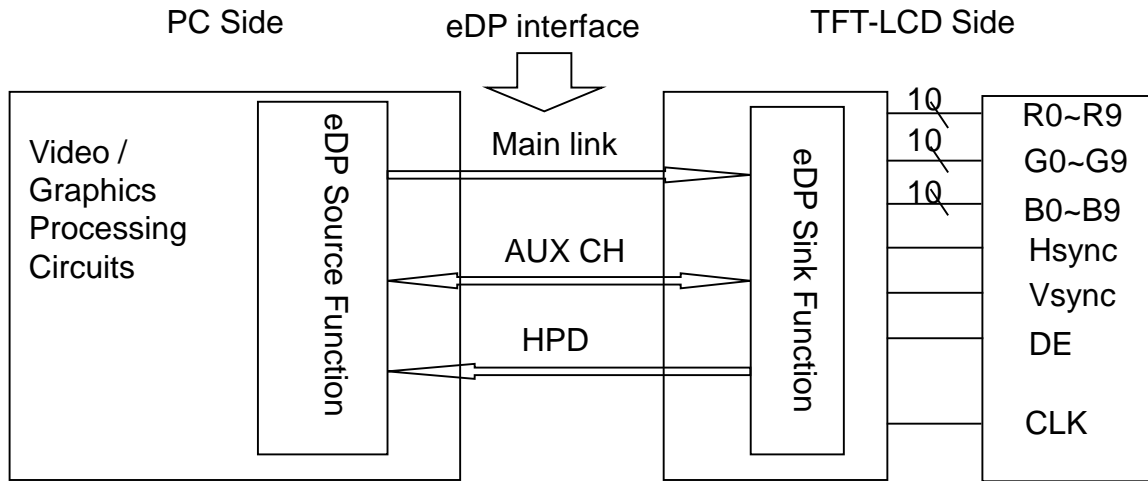

### 5.4 eDP Rx Interface Timing Parameter

#### 5.4.1 Main link Signal

Item	Symbols	Min	Typ	Max	Unit	Remark
Spread spectrum clock	SSC	-0.5	-	+0.5	%	
Main link swing voltage	$ V_{ID} $	100	-	1320	mv	
Main link common mode voltage	$V_{IC}$	0	-	2.0	V	

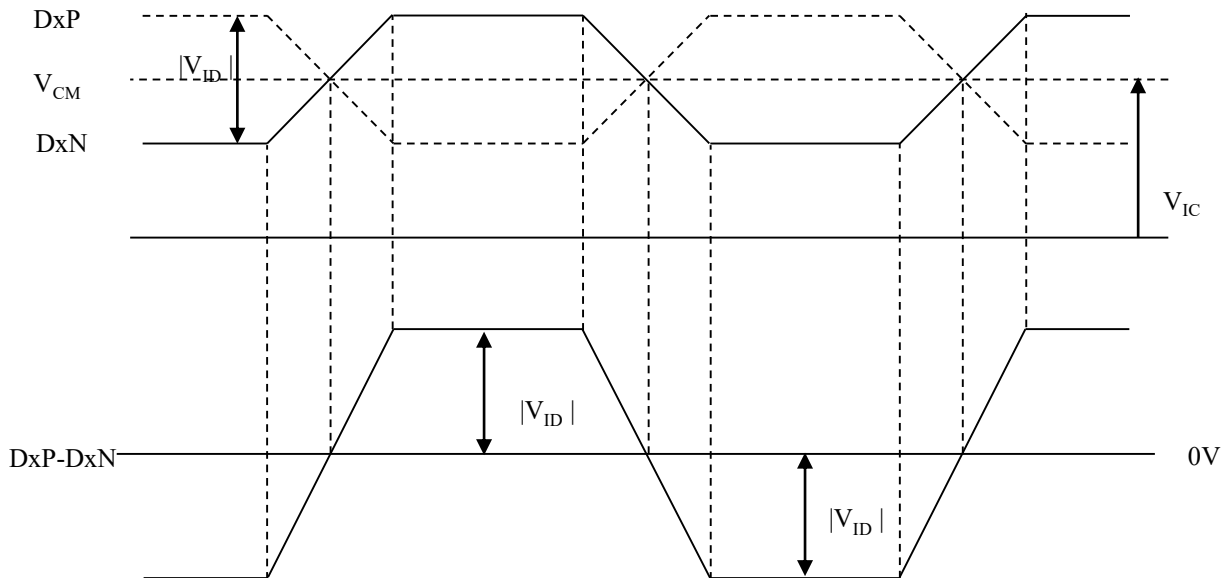

#### 5.4.2 AUX\_CH Signal

Item	Symbols	Min	Typ	Max	Unit	Remark
AUX Peak-to-peak voltage at Connector Pins of Receiving	$ V_{ID\_AUX} $	0.27	-	1.36	V	
AUX DC common mode voltage	$V_{AUX-CM}$	0	-	2	V	

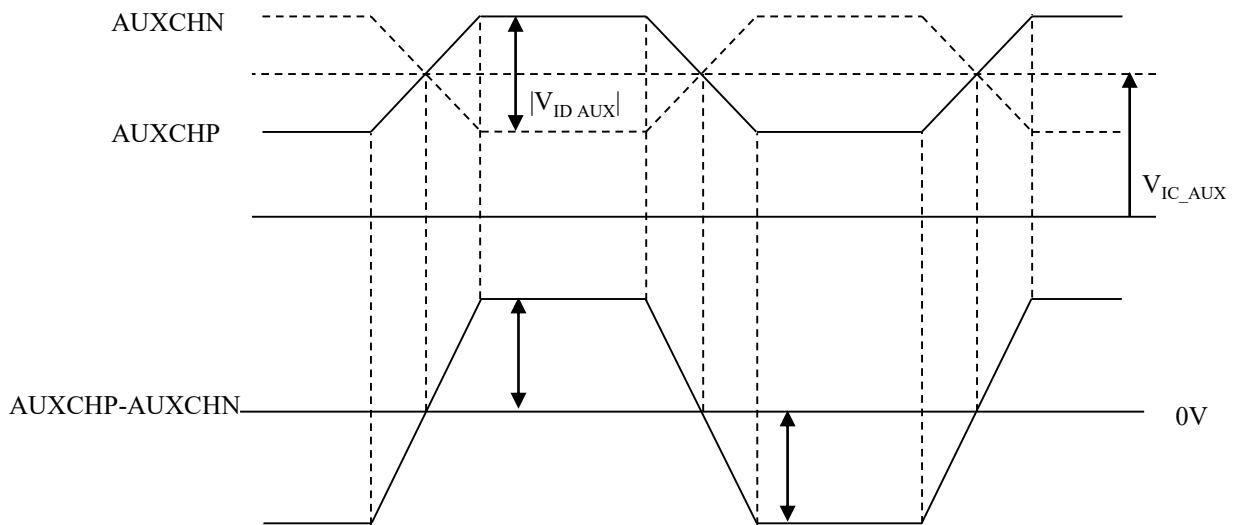

#### 5.4.3 HDP Signal

Item	Symbols	Min	Typ	Max	Unit	Remark
HPD Voltage	VHPD	3.135	3.3	3.465	V	



## 6.0 SIGNAL TIMING SPECIFICATION

6.1 The MV270QUM-N50 is operated by the DE only.

Item	Symbols		Min	Typ	Max	Unit	Note
DCLK	Period	tCLK	1.8	1.9	2.2	ns	
	Frequency	-	444	533	551	MHz	
Hsync	Period	tHP	3950	4000	4088	tCLK	
	Horizontal Valid	tHV	3840			tCLK	
	Horizontal Blank	tHB	110	160	248	tCLK	
	Frequency	fH	111	133.3	137	KHz	
Vsync	Period	tVP	2213	2222	2290	tHP	
	Vertical Valid	tVV	2160			tHP	
	Vertical Blank	tVB	53	62	130	tHP	
	Frequency	fV	50	60	62	Hz	Adaptive sync: 40-60Hz



## 8.0 POWER SEQUENCE

VDD power, eDP signal and backlight on/off sequence are as following. eDP signals from any system shall be Hi-Z state when VDD is off.

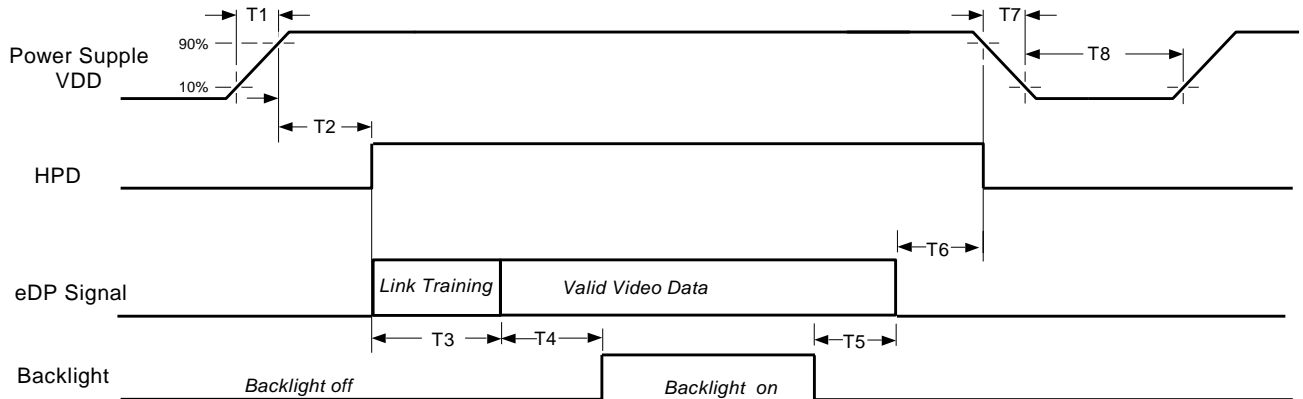

Timing Parameter	Value			Remarks
	Min.	Typ.	Max.	
T1	0.5ms	-	10ms	
T2	0ms	-	200ms	
T3	0ms	-	-	During T3 Period, eDP link training time by customer's system.
T4	500ms	-	-	
T5	100ms	-	-	
T6	0ms	-	50ms	Recommend setting T6=0ms to avoid electronic noise when VDD is off. During T6 period, please keep the level of input eDP signals with Hi-Z state.
T7	0ms	-	10ms	T7 decreases smoothly, there is none re-bouncing voltage.
T8	1000ms	-	-	

### Notes:

1. When the power supply VDD is 0V, keep the level of input signals on the low or keep high impedance.
2. Do not keep the interface signal high impedance when power is on.
3. Back Light must be turn on after power for logic and interface signal are valid.

## 9.0 MECHANICAL CHARACTERISTICS

### 9.1 Dimensional Requirements

FIGURE 6 (located in Appendix) shows mechanical outlines for the model MV270QUM-N50. Other parameters are shown in Table 5.

<Table 5. Dimensional Parameters>

Parameter	Specification	Unit
Dimensional outline	609.4(H) × 355.6(V) × 13.3(Depth)	mm
Weight	2450(Typ.) / 2600(Max.)	gram
Active area	596.736(H) × 335.664 (V)	mm
Pixel pitch	0.1554(H) × 0.1554(V)	mm
Number of pixels	3840 (H)×2160 (V) (1 pixel = R + G + B dots)	pixels
Back-light	Down side, 1-LED Lighting Bar type	

### 9.2 Mounting

See FIGURE 5. ( shown in Appendix )

### 9.3 Anti-Glare and Polarizer Hardness.

The surface of the LCD has an anti-glare coating to minimize reflection and a coating to reduce scratching.

### 10.0 RELIABILITY TEST

The Reliability test items and its conditions are shown in below.

<Table 6. Reliability Test Parameters >

No	Test Items	Conditions	
1	High temperature storage test	Ta = 60 °C, 240 hrs	
2	Low temperature storage test	Ta = -20 °C, 240 hrs	
3	High temperature & high humidity operation test	Ta = 50 °C, 80%RH, 240hrs	
4	High temperature operation test	Ta = 50 °C, 240hrs	
5	Low temperature operation test	Ta = 0°C, 240hrs	
6	Thermal shock	Ta = -20 °C ↔ 60 °C (0.5 hr), 100 cycle	
7	Vibration test (non-operating)	Frequency	Random, 10 ~ 300 Hz, 30 min/Axis
		Gravity\ AMP	1.5 Grms
		Period	X, Y, Z 30 min
8	Shock test (non-operating)	Gravity	50G
		Pulse width	11msec, sine wave
		Direction	±X, ±Y, ±Z Once for each
9	Electro-static discharge test	Air : 150 pF, 330Ω, 15 KV Contact : 150 pF, 330Ω, 8 KV	

## 11.0 HANDLING & CAUTIONS

### (1) Cautions when taking out the module

- Pick the pouch only, when taking out module from a shipping package.

### (2) Cautions for handling the module

- As the electrostatic discharges may break the LCD module, handle the LCD module with care. Peel a protection sheet off from the LCD panel surface as slowly as possible.
- As the LCD panel and back - light element are made from fragile glass material, impulse and pressure to the LCD module should be avoided.
- As the surface of the polarizer is very soft and easily scratched, use a soft dry cloth without chemicals for cleaning.
- Do not pull the interface connector in or out while the LCD module is operating.
- Put the module display side down on a flat horizontal plane.
- Handle connectors and cables with care.

### (3) Cautions for the operation

- When the module is operating, do not lose CLK, ENAB signals. If any one of these signals is lost, the LCD panel would be damaged.
- Obey the supply voltage sequence. If wrong sequence is applied, the module would be damaged.

### (4) Cautions for the atmosphere

- Dew drop atmosphere should be avoided.
- Do not store and/or operate the LCD module in a high temperature and/or humidity atmosphere. Storage in an electro-conductive polymer packing pouch and under relatively low temperature atmosphere is recommended.

### (5) Cautions for the module characteristics

- Do not apply fixed pattern data signal to the LCD module at product aging.
- Applying fixed pattern for a long time may cause image sticking.

### (6) Other cautions

- Do not disassemble and/or re-assemble LCD module.
- Do not re-adjust variable resistor or switch etc.
- When returning the module for repair or etc., Please pack the module not to be broken. We recommend to use the original shipping packages.

## 12.0 PRODUCT SERIAL NUMBER

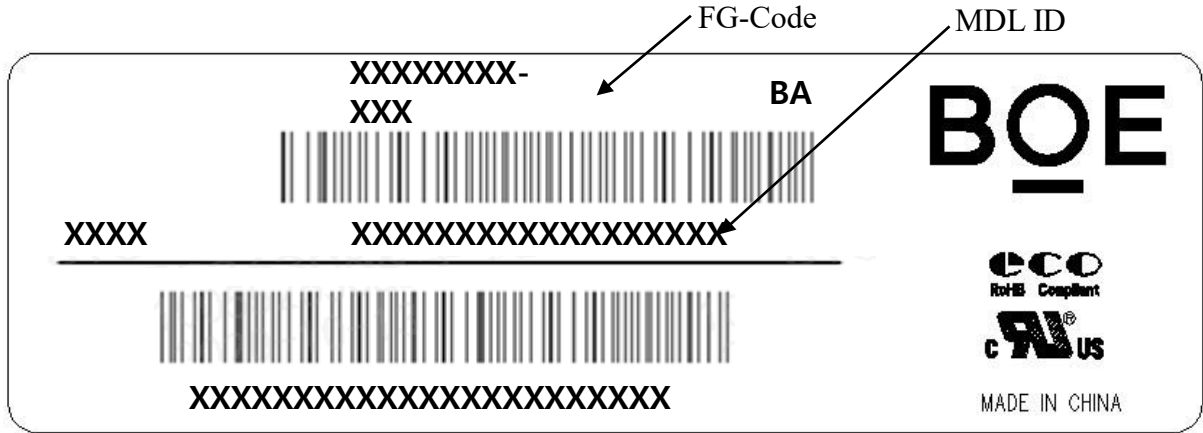

### MDL ID Naming Rule:

Digit	1	2	3	4	5	6						7					
Code	x	x	x	x	x	x	x	x	x	x	x	x	x	x	x	x	x
Des.	1. Model Code GBN 2. Grade 3. Line 4. Year(2016:16, 2017:17, ...) 5. Month(1, 2, 3, ..., 9, X, Y, Z) 6. Model Extension Code 7. Serial Number																

## 13.0 Packing

### 13.1 Packing Order

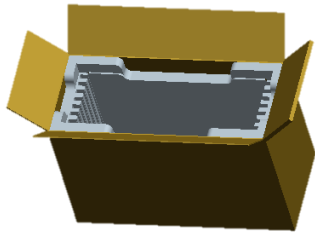

Put 1 EPO bottom into the inner box.

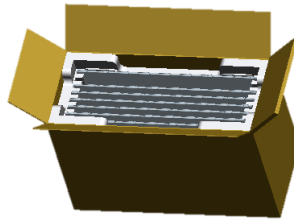

Put each module into a PE bag. Insert 7Pcs MDL into each box.

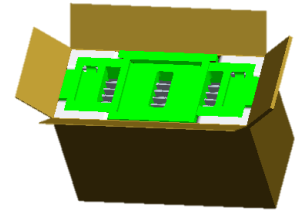

Put 1 EPO cover in and seal the box.

NO.	Description	Material
1	Bottom	EPO
2	Cover	EPO
3	PE BAG	PE
4	Protection	PET
5	Paper Corner	Paper
6	Pallet	Wood

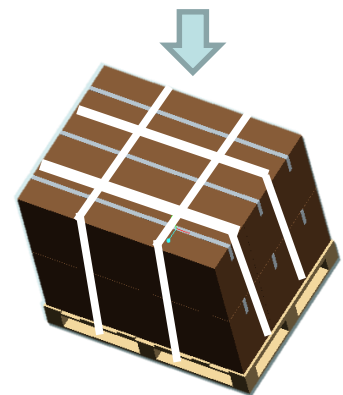

Put the boxes on the pallet (12ea boxes per pallet) .Place paper corners and wrap film around the boxes.Pack with 4 packing belts.

Car loading mode: double layer stacking(2+2)

Pallet Placement : One horizontal, one vertical

12m container : 3444pcs (41托)



### 13.2 Packing Note

- Box Dimension : 687mm(L) × 289mm(W) × 461mm(H)
- Package Quantity in one Box : 7pcs

### 13.3 Box label

- Label Size : 100 mm (L) × 50 mm (W)
- Contents
  - Model : MV270QUM-N50
  - Q`ty : Module 7 Q`ty in one box
  - Serial No. : Box Serial No. See next page for detail description.
  - Date : Packing Date

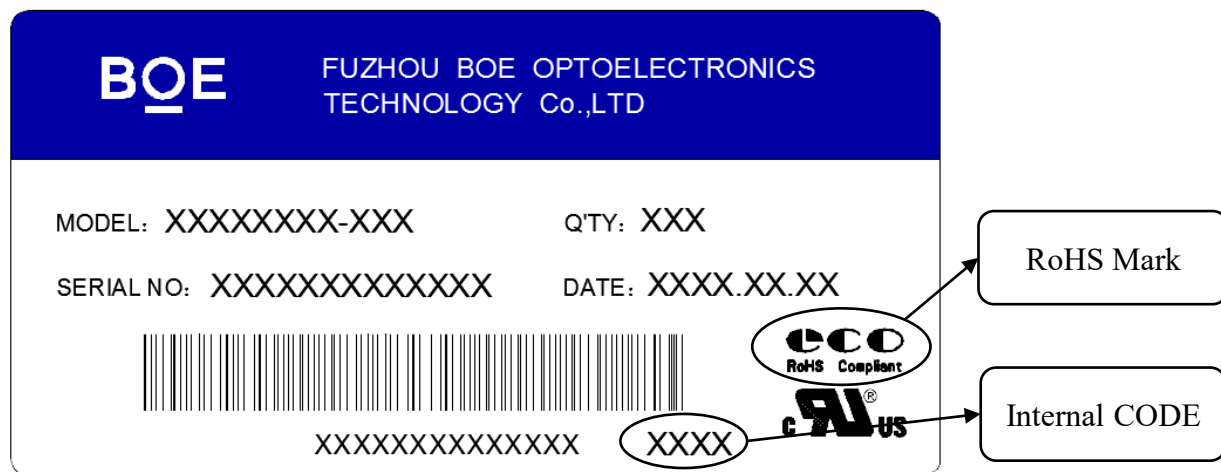

Digit	1	2	3	4	5	6	7						
Code	x	x	x	x	x	x	x	x	x	x	x	x	x
Des.	1. Model Code GBN 2. Grade 3. Line 4. Year(2016:16, 2017:17, ...) 5. Month(1, 2, 3, ..., 9, X, Y, Z) 6. Revision Code 7. Serial Number												

## 14.0 APPENDIX

**Figure 1. Measurement Set Up**

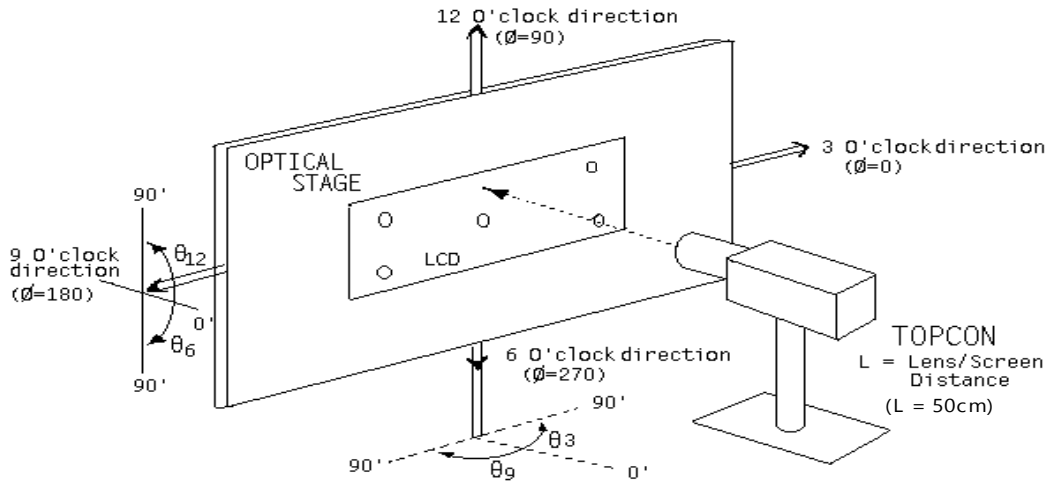

**Figure 2. White Luminance and Uniformity Measurement Locations (9 points)**

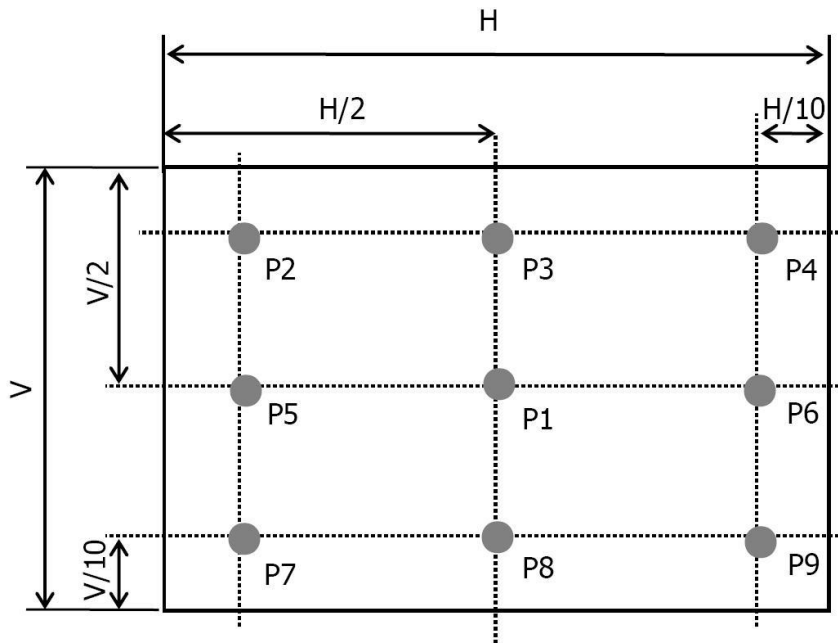

**Figure 3. Response Time Testing**

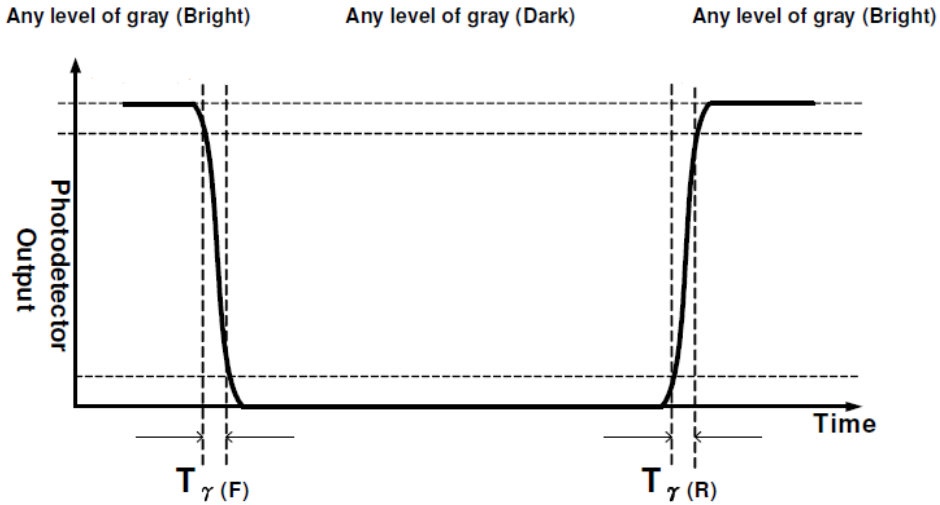

**Figure 4. Cross Modulation Test Description**

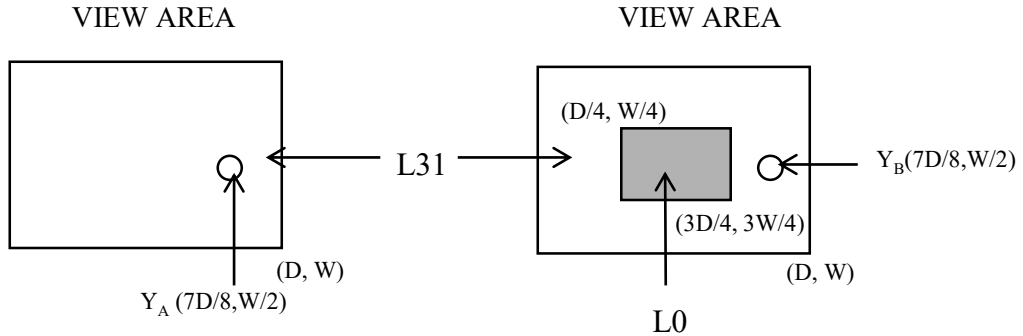

$$\text{Cross-Talk (\%)} = \left| \frac{Y_B - Y_A}{Y_A} \right| \times 100$$

Where:  $Y_A$  = Initial luminance of measured area (cd/m<sup>2</sup>)  
 $Y_B$  = Subsequent luminance of measured area (cd/m<sup>2</sup>)  
 The location measured will be exactly the same in both patterns

**Figure 5. TFT-LCD Module Outline Dimensions (Front view)**

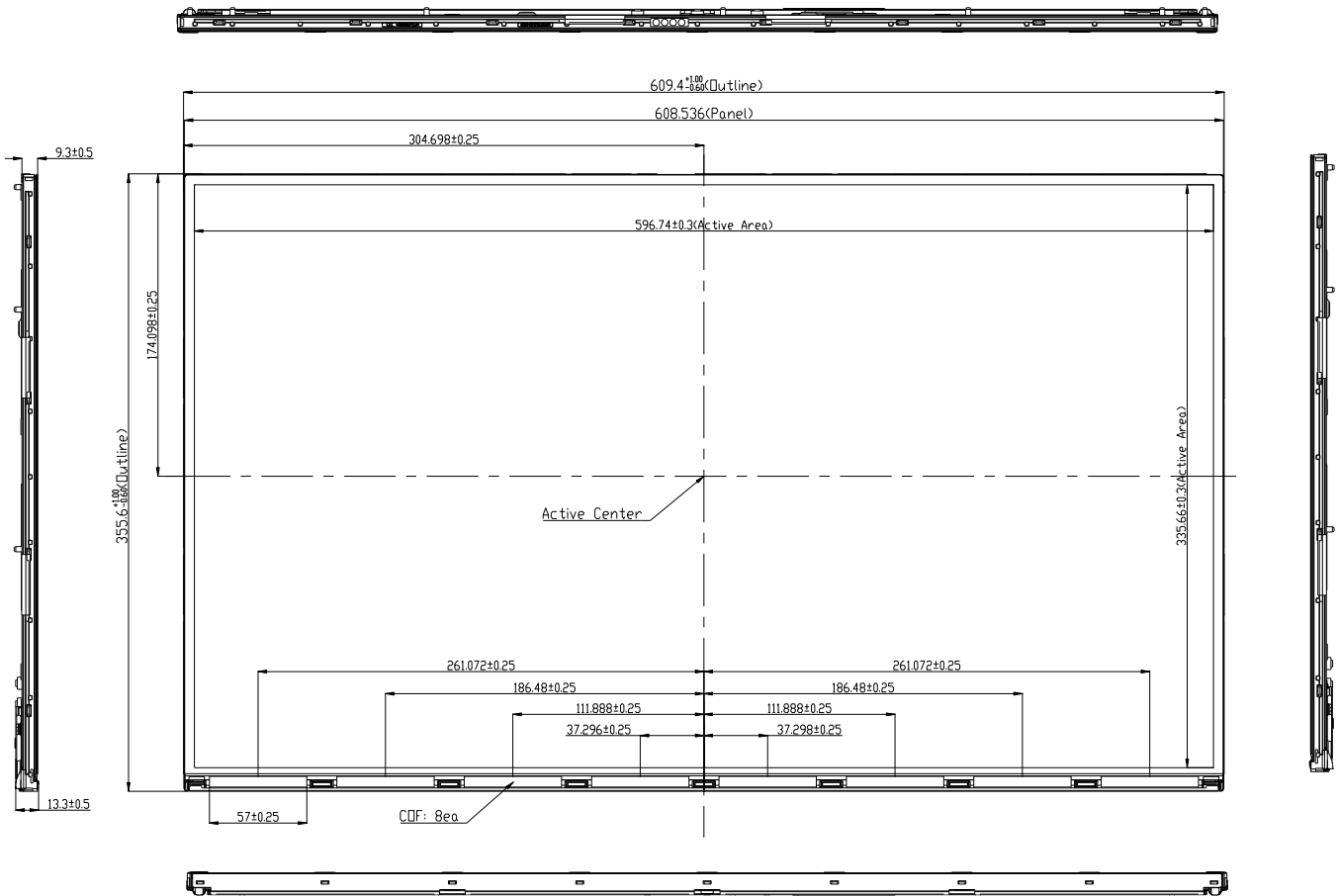

**Figure 6. TFT-LCD Module Outline Dimensions (Rear view)**

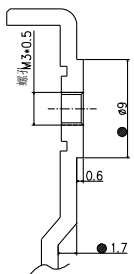
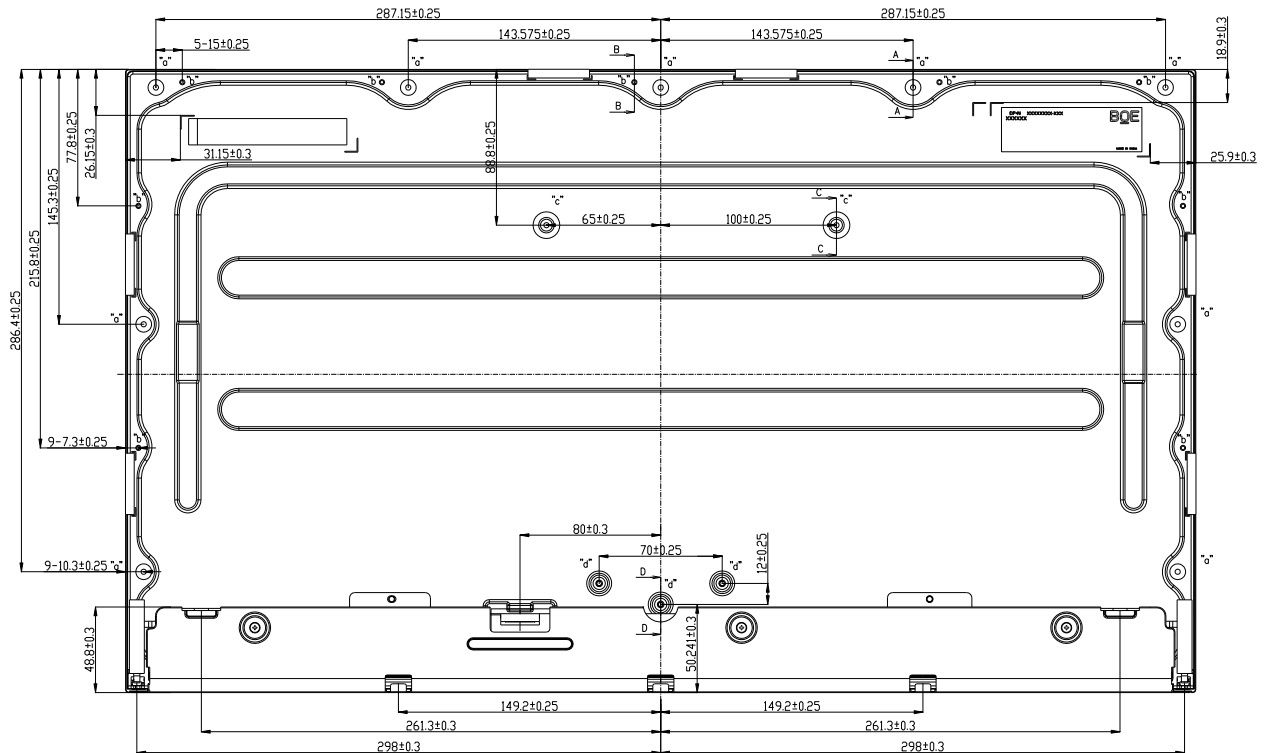

SECTION A-A (Scale: 5/1)  
Total 9pcs "a"

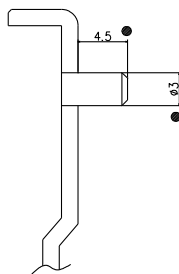

Section B-B(S:5/1)  
Total 9pcs "b"

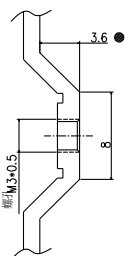

Section C-C(S:5/1)  
Total 2pcs "c"

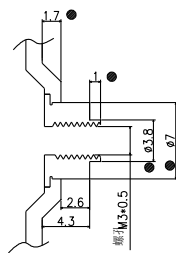

Section D-D(S:5/1)  
Total 3pcs "d"

**NOTE:**

1. I/F CONNECTOR SPECIFICATION  
MSAK24025P30 or EQUIVALENT
2. LED CONNECTOR SPECIFICATION  
3711K-Q06N-01R or EQUIVALENT
3. TORQUE of USER HOLE: 3.0~4.0kgf-cm
4. Tilt and partial disposition tolerance of display area as following
  - (1) Y-direction:  $-0.35 \leq A \leq 0.35$ ,  $-0.35 \leq B \leq 0.35$
  - (2) X-direction:  $-0.35 \leq C \leq 0.35$ ,  $-0.35 \leq D \leq 0.35$

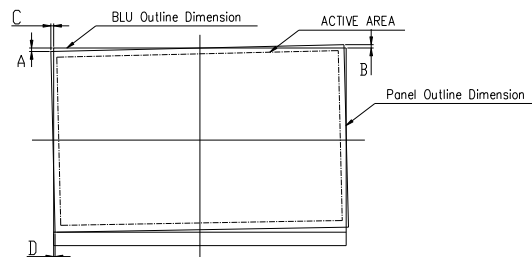

5. Unspecified tolerance to be ±0.5
6. The LCM warp is less than 1.0 on the surface plate
7. The COF area is weak and sensitive, so please don't press the COF area

**15.0 International Standards****1. Safety**

1. UL 62368-1, 2nd Ed, 2014-12-01 (Audio/video, information and communication technology equipment Part 1: Safety requirements)
2. CAN/CSA C22.2 No. 62368-1-14, 2nd Ed (Audio/video, information and communication technology equipment Part 1: Safety requirements)
3. IEC 62368-1:2014 (Second Edition)

**2. Environment**

1. RoHS, Commission Delegated Directive (EU) 2015/863 of 31 March 2015 amending Annex II to Directive 2011/65/EU of the European Parliament and of the Council