

# Spec Sheet

Part No.: DT001WC0540009H

Page: 1/1

## Features

- Qi Standard compliance
- High mechanical intensity
- High temperature protection design

## Applications

- Automobile wireless charging
- Mobile charger
- Game charging equipment
- Smart home wireless charging equipment, etc.

## Environmental Data

- Storage temperature range: -25°C to + 65°C
- Operating temperature range: -40°C to + 125°C (including coil's self-temperature rise)
- Moisture sensitivity level: 1
- RoHS&HF compliance



## Packaging

- Tray and carton box packaging

## Mechanical Dimension(Unit:mm)

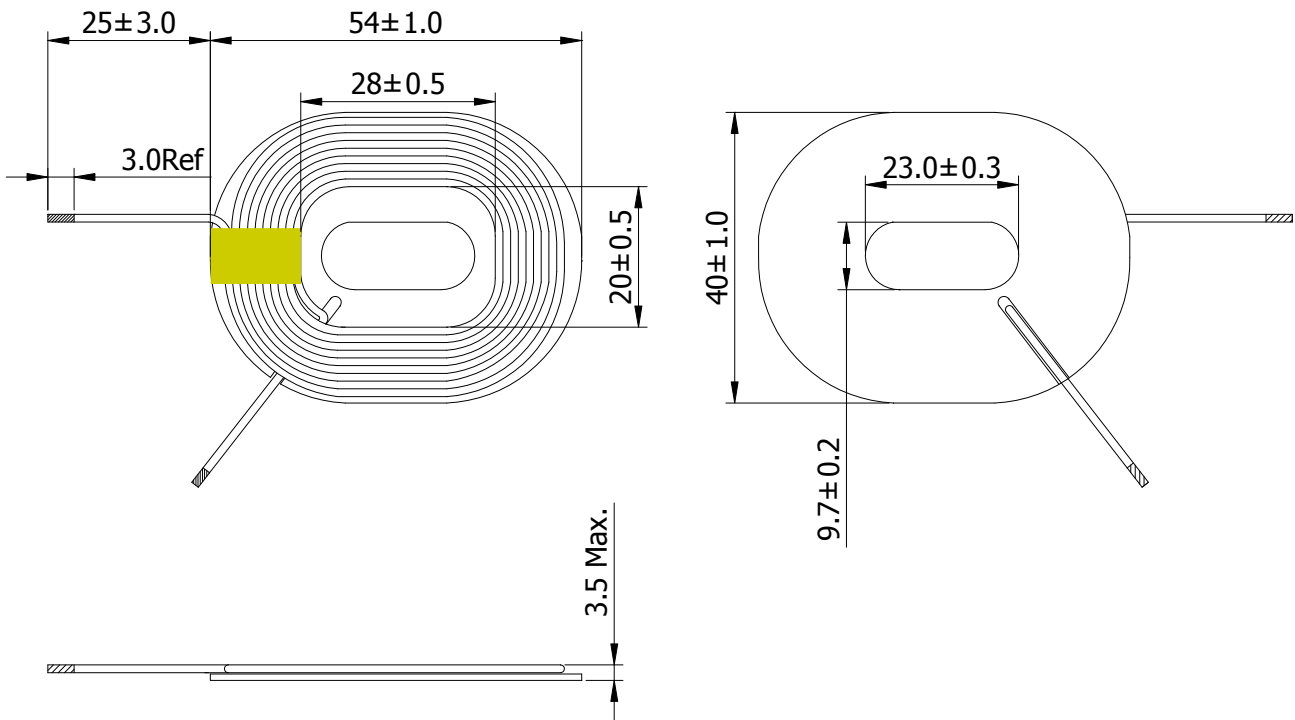

## Electrical Characteristic

■ L	6.5uH±10%
■ Test frequency and voltage	100KHz, 1.0Vrms
■ DCR	52mΩ Max.(40mΩ Typ.)
■ Turns	9Ts
■ Weight	13.1g/pc

■ All test data referenced to 25°C ambient.