

MJD44H11 (NPN), MJD45H11 (PNP)

THERMAL CHARACTERISTICS

Characteristic	Symbol	Max	Unit
Thermal Resistance, Junction-to-Case	$R_{\theta JC}$	6.25	$^{\circ}C/W$
Thermal Resistance, Junction-to-Ambient (Note 2)	$R_{\theta JA}$	71.4	$^{\circ}C/W$
Lead Temperature for Soldering	T_L	260	$^{\circ}C$

2. These ratings are applicable when surface mounted on the minimum pad sizes recommended.

ELECTRICAL CHARACTERISTICS

($T_A = 25^{\circ}C$, common for NPN and PNP, minus sign, “-”, for PNP omitted, unless otherwise noted)

Characteristic	Symbol	Min	Typ	Max	Unit
----------------	--------	-----	-----	-----	------

OFF CHARACTERISTICS

Collector-Emitter Sustaining Voltage ($I_C = 30\text{ mA}$, $I_B = 0$)	$V_{CE(sus)}$	80	-	-	Vdc
Collector Cutoff Current ($V_{CE} = \text{Rated } V_{CEO}$, $V_{BE} = 0$)	I_{CES}	-	-	1.0	μA
Emitter Cutoff Current ($V_{EB} = 5\text{ Vdc}$)	I_{EBO}	-	-	1.0	μA

ON CHARACTERISTICS

Collector-Emitter Saturation Voltage ($I_C = 8\text{ Adc}$, $I_B = 0.4\text{ Adc}$)	$V_{CE(sat)}$	-	-	1	Vdc
Base-Emitter Saturation Voltage ($I_C = 8\text{ Adc}$, $I_B = 0.8\text{ Adc}$)	$V_{BE(sat)}$	-	-	1.5	Vdc
DC Current Gain ($V_{CE} = 1\text{ Vdc}$, $I_C = 2\text{ Adc}$) ($V_{CE} = 1\text{ Vdc}$, $I_C = 4\text{ Adc}$)	h_{FE}	60 40	- -	- -	-

DYNAMIC CHARACTERISTICS

Collector Capacitance ($V_{CB} = 10\text{ Vdc}$, $f_{\text{test}} = 1\text{ Mhz}$) MJD44H11 MJD45H11	C_{cb}	- -	45 130	- -	pF
Gain Bandwidth Product ($I_C = 0.5\text{ Adc}$, $V_{CE} = 10\text{ Vdc}$, $f = 20\text{ Mhz}$) MJD44H11 MJD45H11	f_T	- -	85 90	- -	MHz

SWITCHING TIMES

Delay and Rise Times ($I_C = 5\text{ Adc}$, $I_{B1} = 0.5\text{ Adc}$) MJD44H11 MJD45H11	$t_d + t_r$	- -	300 135	- -	ns
Storage Time ($I_C = 5\text{ Adc}$, $I_{B1} = I_{B2} = 0.5\text{ Adc}$) MJD44H11 MJD45H11	t_s	- -	500 500	- -	ns
Fall Time ($I_C = 5\text{ Adc}$, $I_{B1} = I_{B2} = 0.5\text{ Adc}$) MJD44H11 MJD45H11	t_f	- -	140 100	- -	ns

Product parametric performance is indicated in the Electrical Characteristics for the listed test conditions, unless otherwise noted. Product performance may not be indicated by the Electrical Characteristics if operated under different conditions.

MJD44H11 (NPN), MJD45H11 (PNP)

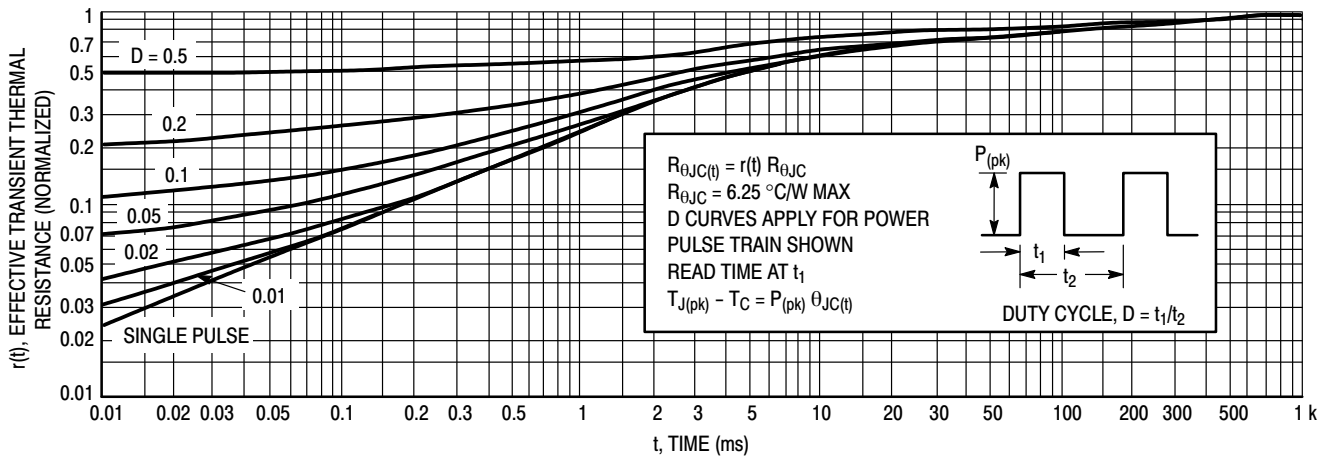

Figure 1. Thermal Response

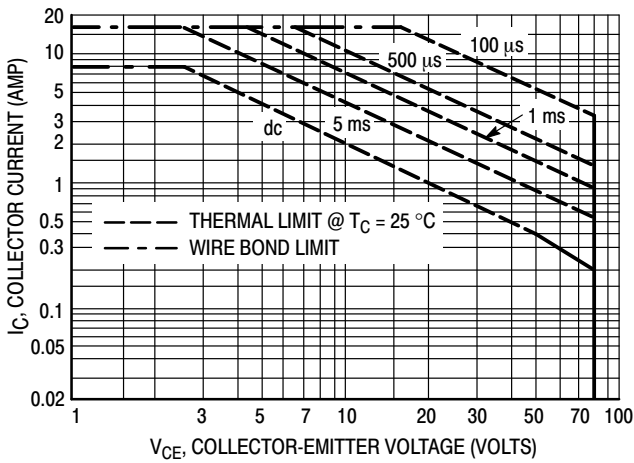

Figure 2. Maximum Forward Bias Safe Operating Area

There are two limitations on the power handling ability of a transistor: average junction temperature and second breakdown. Safe operating area curves indicate I_C – V_{CE} limits of the transistor that must be observed for reliable operation; i.e., the transistor must not be subjected to greater dissipation than the curves indicate.

The data of Figure 2 is based on T_{J(pk)} = 150 °C; T_C is variable depending on conditions. Second breakdown pulse limits are valid for duty cycles to 10% provided T_{J(pk)} ≤ 150 °C. T_{J(pk)} may be calculated from the data in Figure 1. At high case temperatures, thermal limitations will reduce the power that can be handled to values less than the limitations imposed by second breakdown.

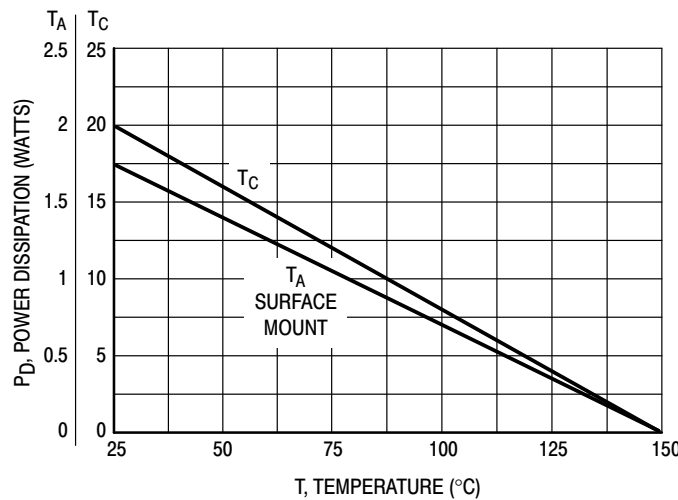

Figure 3. Power Derating

MJD44H11 (NPN), MJD45H11 (PNP)

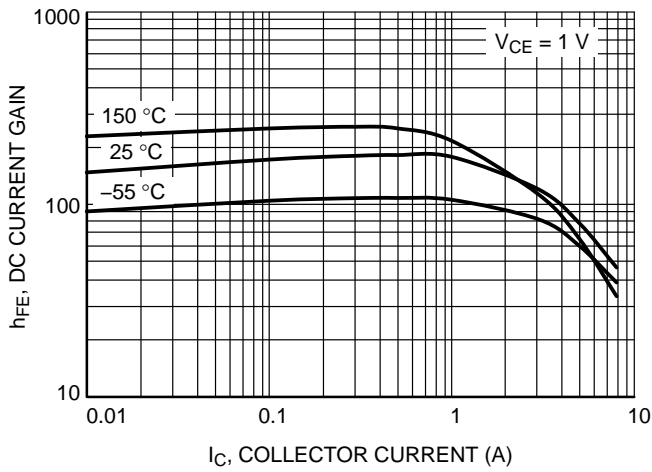

Figure 4. MJD44H11 DC Current Gain

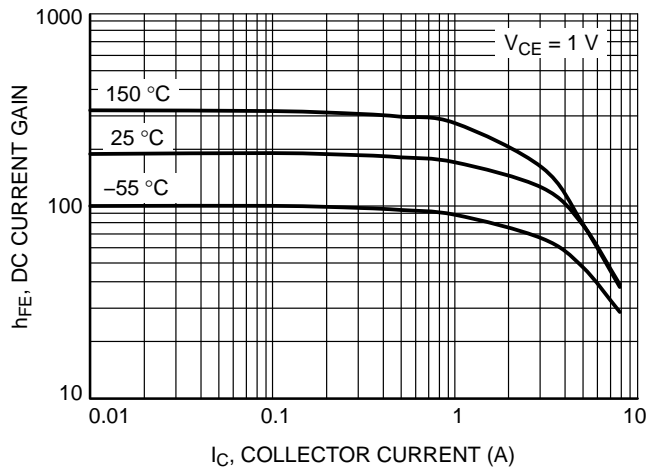

Figure 5. MJD45H11 DC Current Gain

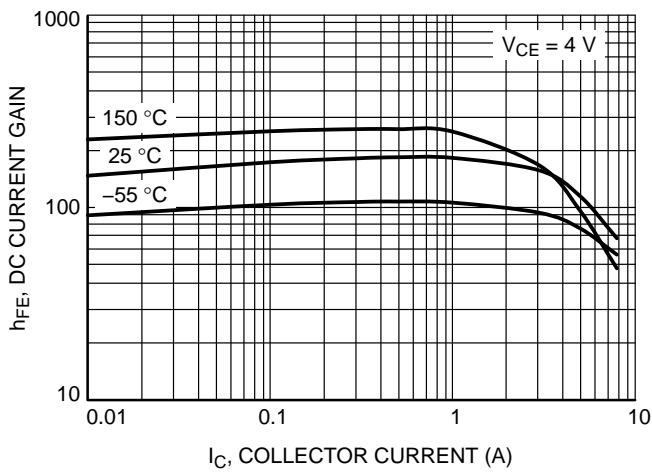

Figure 6. MJD44H11 DC Current Gain

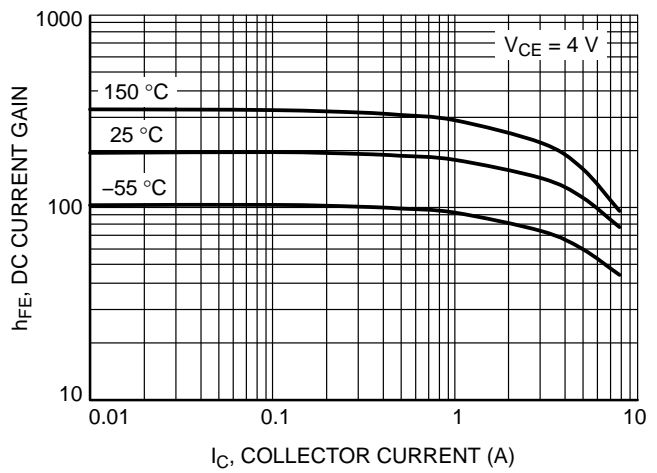

Figure 7. MJD45H11 DC Current Gain

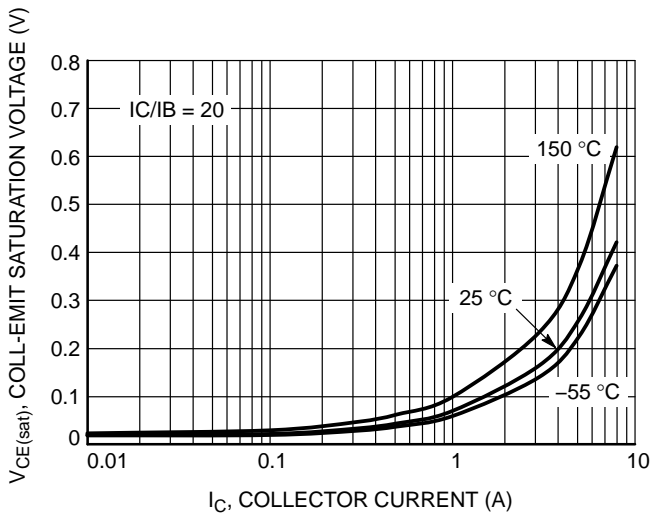

Figure 8. MJD44H11 Saturation Voltage
 $V_{CE(sat)}$

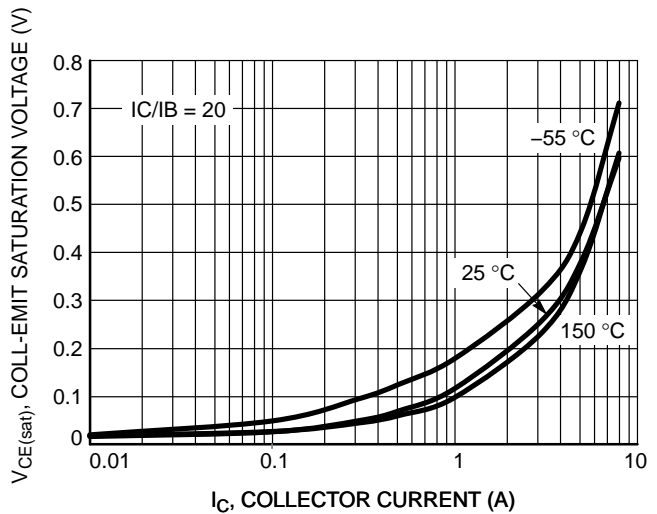

Figure 9. MJD45H11 Saturation Voltage
 $V_{CE(sat)}$

MJD44H11 (NPN), MJD45H11 (PNP)

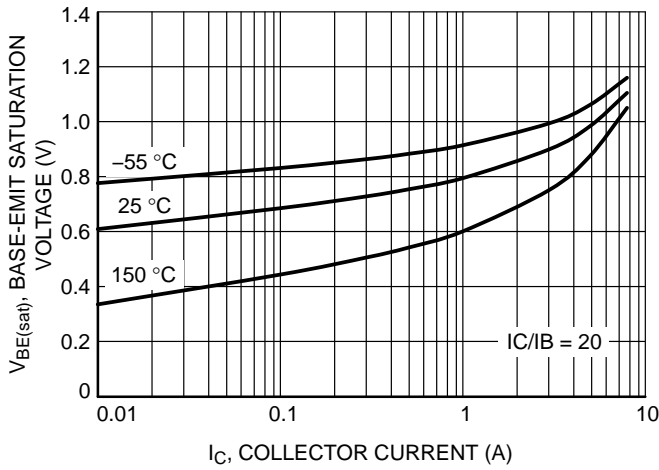

Figure 10. MJD44H11 Saturation Voltage
 $V_{BE(sat)}$

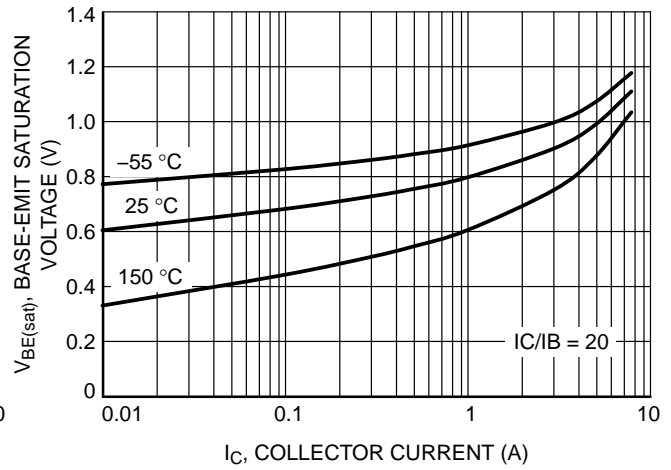

Figure 11. MJD45H11 Saturation Voltage
 $V_{BE(sat)}$

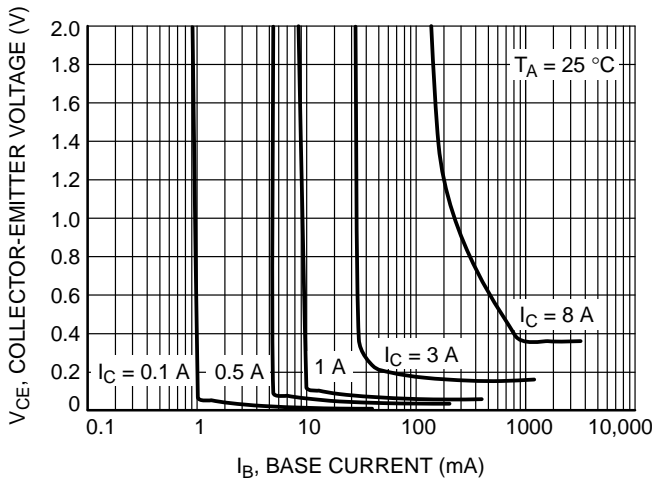

Figure 12. MJD44H11 Collector Saturation Region

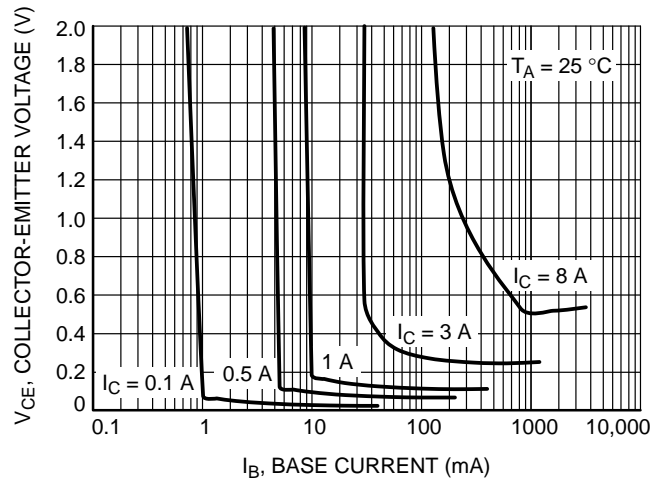

Figure 13. MJD45H11 Collector Saturation Region

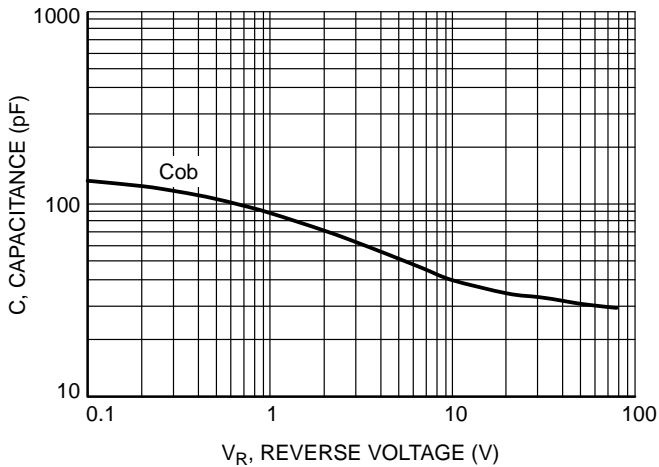

Figure 14. MJD44H11 Capacitance

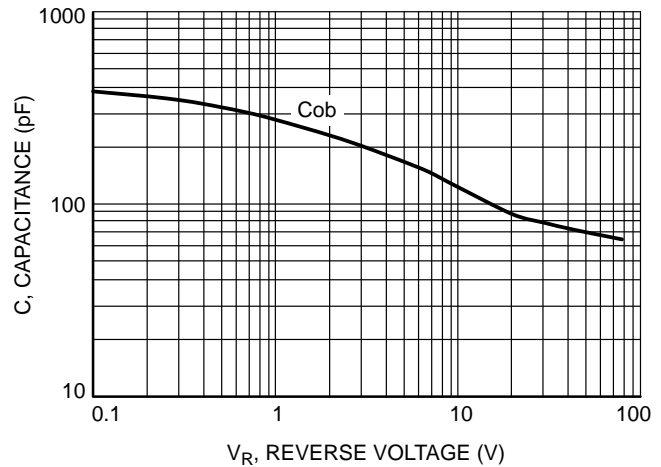

Figure 15. MJD45H11 Capacitance

MJD44H11 (NPN), MJD45H11 (PNP)

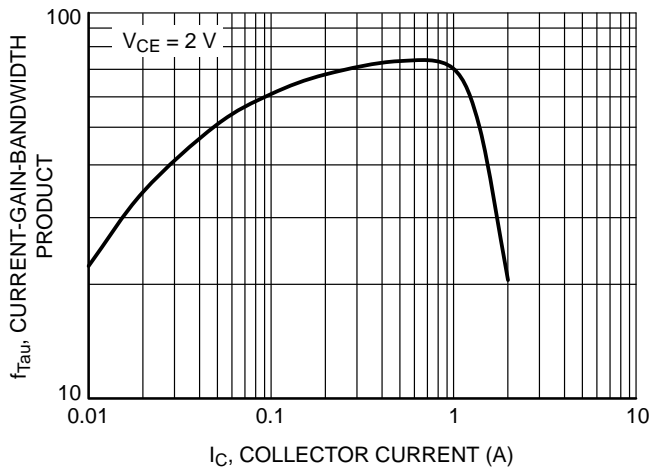

Figure 16. MJD44H11 Current-Gain-Bandwidth Product

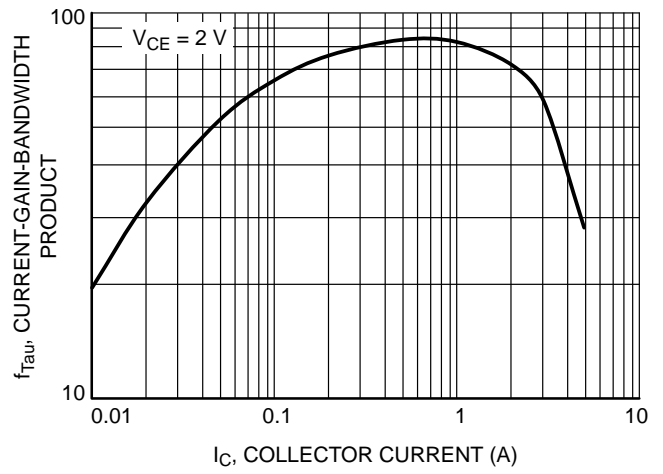

Figure 17. MJD45H11 Current-Gain-Bandwidth Product

MJD44H11 (NPN), MJD45H11 (PNP)

ORDERING INFORMATION

Device	Package Type	Package	Shipping†
MJD44H11G	DPAK (Pb-Free)	369C	75 Units / Rail
NJVMJD44H11G	DPAK (Pb-Free)	369C	75 Units / Rail
MJD44H11-1G	IPAK (Pb-Free)	369D	75 Units / Rail
MJD44H11RLG	DPAK (Pb-Free)	369C	1,800 / Tape & Reel
NJVMJD44H11RLG*	DPAK (Pb-Free)	369C	1,800 / Tape & Reel
MJD44H11T4G	DPAK (Pb-Free)	369C	2,500 / Tape & Reel
NJVMJD44H11T4G*	DPAK (Pb-Free)	369C	2,500 / Tape & Reel
MJD45H11G	DPAK (Pb-Free)	369C	75 Units / Rail
NJVMJD45H11G*	DPAK (Pb-Free)	369C	75 Units / Rail
MJD45H11-1G	IPAK (Pb-Free)	369D	75 Units / Rail
MJD45H11RLG	DPAK (Pb-Free)	369C	1,800 / Tape & Reel
NJVMJD45H11RLG*	DPAK (Pb-Free)	369C	1,800 / Tape & Reel
MJD45H11T4G	DPAK (Pb-Free)	369C	2,500 / Tape & Reel
NJVMJD45H11T4G*	DPAK (Pb-Free)	369C	2,500 / Tape & Reel

DISCONTINUED (Note 3)

MJD44H11T5G	DPAK (Pb-Free)	369C	2,500 / Tape & Reel
NJVMJD44H11D3T4G*	DPAK (Pb-Free)	369G	2,500 / Tape & Reel
NJVMJD45H11D3T4G*	DPAK (Pb-Free)	369G	2,500 / Tape & Reel

† For information on tape and reel specifications, including part orientation and tape sizes, please refer to our Tape and Reel Packaging Specifications Brochure, [BRD8011/D](#).

* NJV Prefix for Automotive and Other Applications Requiring Unique Site and Control Change Requirements; AEC-Q101 Qualified and PPAP Capable

3. **DISCONTINUED:** These devices are not available. Please contact your **onsemi** representative for information. The most current information on these devices may be available on www.onsemi.com.

MJD44H11 (NPN), MJD45H11 (PNP)

REVISION HISTORY

Revision	Description of Changes	Date
22	Updated Package type in Ordering Information. MJD44H11T5G, NJVMJD44H11D3T4G, NJVMJD45H11D3T4G OPNs marked as Discontinued.	12/12/2025

This document has undergone updates prior to the inclusion of this revision history table. The changes tracked here only reflect updates made on the noted approval dates.



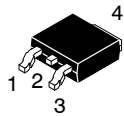

DPAK3 6.10x6.54x2.28, 2.29P
CASE 369C
ISSUE J

DATE 12 AUG 2025

SCALE 1:1

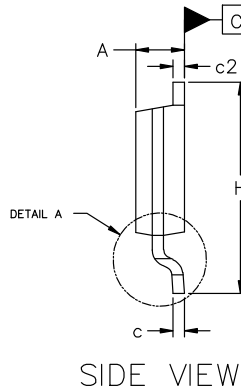
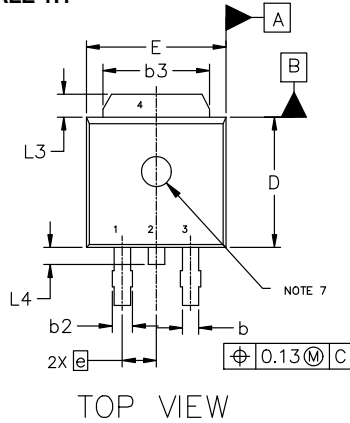

MILLIMETERS			
DIM	MIN	NOM	MAX
A	2.18	2.28	2.38
A1	0.00	---	0.13
b	0.63	0.76	0.89
b2	0.72	0.93	1.14
b3	4.57	5.02	5.46
c	0.46	0.54	0.61
c2	0.46	0.54	0.61
D	5.97	6.10	6.22
E	6.35	6.54	6.73
e	2.29 BSC		
H	9.40	9.91	10.41
L	1.40	1.59	1.78
L1	2.90 REF		
L2	0.51 BSC		
L3	0.89	---	1.27
L4	---	---	1.01
Z	3.93	---	---

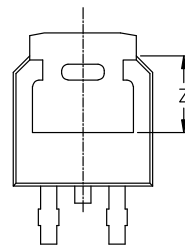
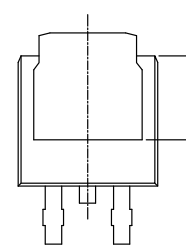
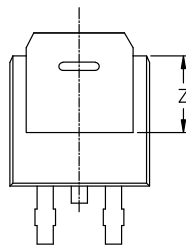
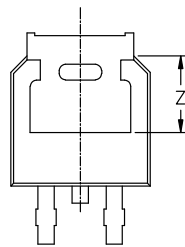
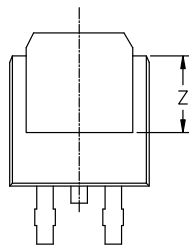

ALTERNATE CONSTRUCTIONS

NOTES:

1. DIMENSIONING AND TOLERANCING ASME Y14.5M, 2018.
2. CONTROLLING DIMENSION: MILLIMETERS.
3. THERMAL PAD CONTOUR OPTIONAL WITHIN DIMENSIONS b3, L3, AND Z.
4. DIMENSIONS D AND E DO NOT INCLUDE MOLD FLASH, PROTRUSIONS, OR BURRS. MOLD FLASH, PROTRUSIONS, OR GATE BURRS SHALL NOT EXCEED 0.15mm PER SIDE.
5. DIMENSIONS D AND E ARE DETERMINED AT THE OUTERMOST EXTREMES OF THE PLASTIC BODY.
6. DATUMS A AND B ARE DETERMINED AT DATUM PLANE H.
7. OPTIONAL MOLD FEATURE.

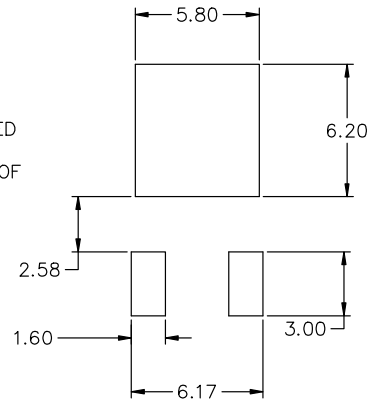
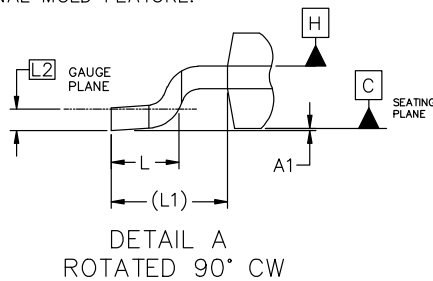

RECOMMENDED MOUNTING FOOTPRINT*

*FOR ADDITIONAL INFORMATION ON OUR PB-FREE STRATEGY AND SOLDERING DETAILS, PLEASE DOWNLOAD THE ONSEMI SOLDERING AND MOUNTING TECHNIQUES REFERENCE MANUAL, SOLDERRM/D.

DOCUMENT NUMBER:	98AON10527D	Electronic versions are uncontrolled except when accessed directly from the Document Repository. Printed versions are uncontrolled except when stamped "CONTROLLED COPY" in red.
DESCRIPTION:	DPAK3 6.10x6.54x2.28, 2.29P	PAGE 1 OF 2

onsemi and Onsemi are trademarks of Semiconductor Components Industries, LLC dba onsemi or its subsidiaries in the United States and/or other countries. onsemi reserves the right to make changes without further notice to any products herein. onsemi makes no warranty, representation or guarantee regarding the suitability of its products for any particular purpose, nor does onsemi assume any liability arising out of the application or use of any product or circuit, and specifically disclaims any and all liability, including without limitation special, consequential or incidental damages. onsemi does not convey any license under its patent rights nor the rights of others.

DPAK3 6.10x6.54x2.28, 2.29P
CASE 369C
ISSUE J

DATE 12 AUG 2025

**GENERIC
MARKING DIAGRAM***

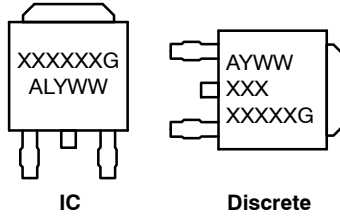

- XXXXXX = Device Code
- A = Assembly Location
- L = Wafer Lot
- Y = Year
- WW = Work Week
- G = Pb-Free Package

*This information is generic. Please refer to device data sheet for actual part marking. Pb-Free indicator, "G" or microdot "▪", may or may not be present. Some products may not follow the Generic Marking.

- | | | | | |
|--|--|---|---|--|
| <p>STYLE 1:
 PIN 1. BASE
 2. COLLECTOR
 3. EMITTER
 4. COLLECTOR</p> | <p>STYLE 2:
 PIN 1. GATE
 2. DRAIN
 3. SOURCE
 4. DRAIN</p> | <p>STYLE 3:
 PIN 1. ANODE
 2. CATHODE
 3. ANODE
 4. CATHODE</p> | <p>STYLE 4:
 PIN 1. CATHODE
 2. ANODE
 3. GATE
 4. ANODE</p> | <p>STYLE 5:
 PIN 1. GATE
 2. ANODE
 3. CATHODE
 4. ANODE</p> |
| <p>STYLE 6:
 PIN 1. MT1
 2. MT2
 3. GATE
 4. MT2</p> | <p>STYLE 7:
 PIN 1. GATE
 2. COLLECTOR
 3. EMITTER
 4. COLLECTOR</p> | <p>STYLE 8:
 PIN 1. N/C
 2. CATHODE
 3. ANODE
 4. CATHODE</p> | <p>STYLE 9:
 PIN 1. ANODE
 2. CATHODE
 3. RESISTOR ADJUST
 4. CATHODE</p> | <p>STYLE 10:
 PIN 1. CATHODE
 2. ANODE
 3. CATHODE
 4. ANODE</p> |

DOCUMENT NUMBER:	98AON10527D	Electronic versions are uncontrolled except when accessed directly from the Document Repository. Printed versions are uncontrolled except when stamped "CONTROLLED COPY" in red.
DESCRIPTION:	DPAK3 6.10x6.54x2.28, 2.29P	PAGE 2 OF 2

onsemi and **Onsemi** are trademarks of Semiconductor Components Industries, LLC dba **onsemi** or its subsidiaries in the United States and/or other countries. **onsemi** reserves the right to make changes without further notice to any products herein. **onsemi** makes no warranty, representation or guarantee regarding the suitability of its products for any particular purpose, nor does **onsemi** assume any liability arising out of the application or use of any product or circuit, and specifically disclaims any and all liability, including without limitation special, consequential or incidental damages. **onsemi** does not convey any license under its patent rights nor the rights of others.

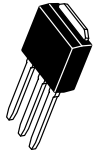

IPAK
CASE 369D
ISSUE C

DATE 15 DEC 2010

SCALE 1:1

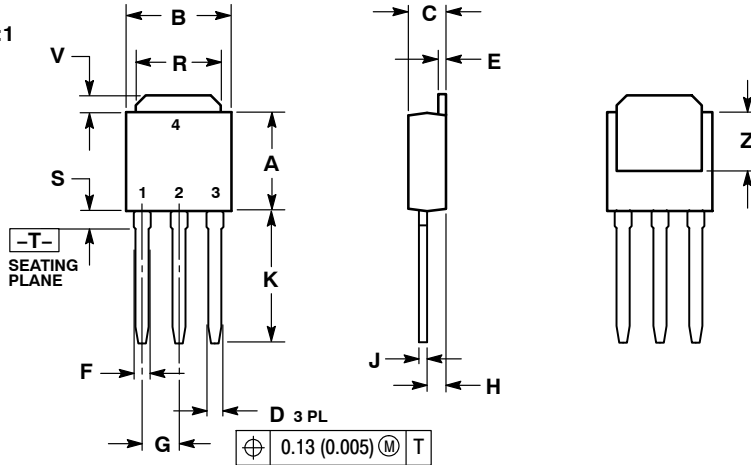

- NOTES:
1. DIMENSIONING AND TOLERANCING PER ANSI Y14.5M, 1982.
2. CONTROLLING DIMENSION: INCH.

DIM	INCHES		MILLIMETERS	
	MIN	MAX	MIN	MAX
A	0.235	0.245	5.97	6.35
B	0.250	0.265	6.35	6.73
C	0.086	0.094	2.19	2.38
D	0.027	0.035	0.69	0.88
E	0.018	0.023	0.46	0.58
F	0.037	0.045	0.94	1.14
G	0.090	BSC	2.29	BSC
H	0.034	0.040	0.87	1.01
J	0.018	0.023	0.46	0.58
K	0.350	0.380	8.89	9.65
R	0.180	0.215	4.45	5.45
S	0.025	0.040	0.63	1.01
V	0.035	0.050	0.89	1.27
Z	0.155	---	3.93	---

GENERIC MARKING
DIAGRAMS

- STYLE 1:
PIN 1. BASE
2. COLLECTOR
3. EMITTER
4. COLLECTOR
- STYLE 2:
PIN 1. GATE
2. DRAIN
3. SOURCE
4. DRAIN
- STYLE 3:
PIN 1. ANODE
2. CATHODE
3. ANODE
4. CATHODE
- STYLE 4:
PIN 1. CATHODE
2. ANODE
3. GATE
4. ANODE
- STYLE 5:
PIN 1. GATE
2. ANODE
3. CATHODE
4. ANODE
- STYLE 6:
PIN 1. MT1
2. MT2
3. GATE
4. MT2
- STYLE 7:
PIN 1. GATE
2. COLLECTOR
3. EMITTER
4. COLLECTOR

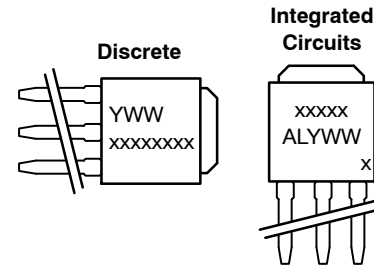

- xxxxxxxx = Device Code
- A = Assembly Location
- IL = Wafer Lot
- Y = Year
- WW = Work Week

*This information is generic. Please refer to device data sheet for actual part marking. Pb-Free indicator, "G" or microdot "•", may or may not be present. Some products may not follow the Generic Marking.

DOCUMENT NUMBER:	98AON10528D	Electronic versions are uncontrolled except when accessed directly from the Document Repository. Printed versions are uncontrolled except when stamped "CONTROLLED COPY" in red.
DESCRIPTION:	IPAK (DPAK INSERTION MOUNT)	PAGE 1 OF 1

onsemi and Onsemi are trademarks of Semiconductor Components Industries, LLC dba onsemi or its subsidiaries in the United States and/or other countries. onsemi reserves the right to make changes without further notice to any products herein. onsemi makes no warranty, representation or guarantee regarding the suitability of its products for any particular purpose, nor does onsemi assume any liability arising out of the application or use of any product or circuit, and specifically disclaims any and all liability, including without limitation special, consequential or incidental damages. onsemi does not convey any license under its patent rights nor the rights of others.

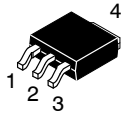

SCALE 1:1

**DPAK-3, SURFACE MOUNT
CASE 369G
ISSUE O**

DATE 23 DEC 2003

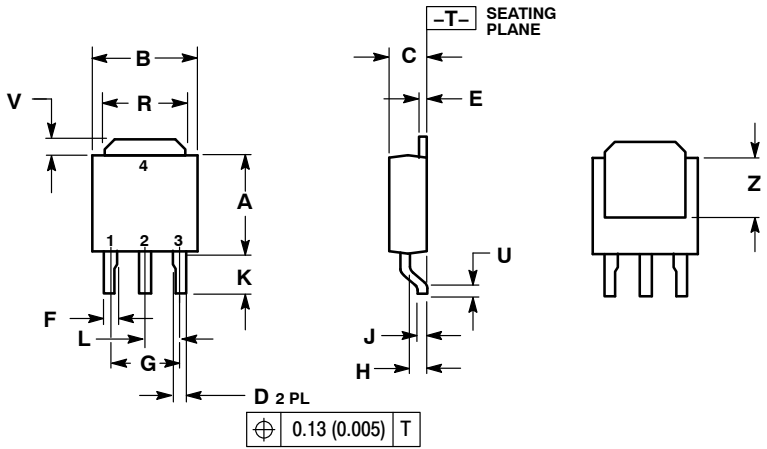

NOTES:
1. DIMENSIONING AND TOLERANCING PER ANSI Y14.5M, 1982.
2. CONTROLLING DIMENSION: INCH.

DIM	INCHES		MILLIMETERS	
	MIN	MAX	MIN	MAX
A	0.235	0.245	5.97	6.22
B	0.250	0.265	6.35	6.73
C	0.086	0.094	2.19	2.38
D	0.027	0.035	0.69	0.88
E	0.018	0.023	0.46	0.58
F	0.037	0.045	0.94	1.14
G	0.180	BSC	4.58	BSC
H	0.034	0.040	0.87	1.01
J	0.018	0.023	0.46	0.58
K	0.102	0.114	2.60	2.89
L	0.090	BSC	2.29	BSC
R	0.180	0.215	4.57	5.45
U	0.020	----	0.51	----
V	0.035	0.050	0.89	1.27
Z	0.155	----	3.93	----

**GENERIC
MARKING DIAGRAM***

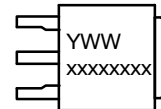

xxxxxxxx = Device Code
Y = Year
WW = Work Week

- STYLE 1:
PIN 1. BASE
2. COLLECTOR
3. EMITTER
4. COLLECTOR
- STYLE 2:
PIN 1. GATE
2. DRAIN
3. SOURCE
4. DRAIN
- STYLE 3:
PIN 1. ANODE
2. CATHODE
3. ANODE
4. CATHODE
- STYLE 4:
PIN 1. CATHODE
2. ANODE
3. GATE
4. ANODE
- STYLE 5:
PIN 1. GATE
2. ANODE
3. CATHODE
4. ANODE
- STYLE 6:
PIN 1. MT1
2. MT2
3. GATE
4. MT2
- STYLE 7:
PIN 1. GATE
2. COLLECTOR
3. EMITTER
4. COLLECTOR

*This information is generic. Please refer to device data sheet for actual part marking.

DOCUMENT NUMBER:	98AON13702D	Electronic versions are uncontrolled except when accessed directly from the Document Repository. Printed versions are uncontrolled except when stamped "CONTROLLED COPY" in red.
DESCRIPTION:	DPAK-3, SURFACE MOUNT	PAGE 1 OF 1

onsemi and ONSEMI are trademarks of Semiconductor Components Industries, LLC dba onsemi or its subsidiaries in the United States and/or other countries. onsemi reserves the right to make changes without further notice to any products herein. onsemi makes no warranty, representation or guarantee regarding the suitability of its products for any particular purpose, nor does onsemi assume any liability arising out of the application or use of any product or circuit, and specifically disclaims any and all liability, including without limitation special, consequential or incidental damages. onsemi does not convey any license under its patent rights nor the rights of others.

onsemi, **Onsemi**, and other names, marks, and brands are registered and/or common law trademarks of Semiconductor Components Industries, LLC dba "**onsemi**" or its affiliates and/or subsidiaries in the United States and/or other countries. **onsemi** owns the rights to a number of patents, trademarks, copyrights, trade secrets, and other intellectual property. A listing of **onsemi**'s product/patent coverage may be accessed at www.onsemi.com/site/pdf/Patent-Marking.pdf. **onsemi** reserves the right to make changes at any time to any products or information herein, without notice. The information herein is provided "as-is" and **onsemi** makes no warranty, representation or guarantee regarding the accuracy of the information, product features, availability, functionality, or suitability of its products for any particular purpose, nor does **onsemi** assume any liability arising out of the application or use of any product or circuit, and specifically disclaims any and all liability, including without limitation special, consequential or incidental damages. Buyer is responsible for its products and applications using **onsemi** products, including compliance with all laws, regulations and safety requirements or standards, regardless of any support or applications information provided by **onsemi**. "Typical" parameters which may be provided in **onsemi** data sheets and/or specifications can and do vary in different applications and actual performance may vary over time. All operating parameters, including "Typicals" must be validated for each customer application by customer's technical experts. **onsemi** does not convey any license under any of its intellectual property rights nor the rights of others. **onsemi** products are not designed, intended, or authorized for use as a critical component in life support systems or any FDA Class 3 medical devices or medical devices with a same or similar classification in a foreign jurisdiction or any devices intended for implantation in the human body. Should Buyer purchase or use **onsemi** products for any such unintended or unauthorized application, Buyer shall indemnify and hold **onsemi** and its officers, employees, subsidiaries, affiliates, and distributors harmless against all claims, costs, damages, and expenses, and reasonable attorney fees arising out of, directly or indirectly, any claim of personal injury or death associated with such unintended or unauthorized use, even if such claim alleges that **onsemi** was negligent regarding the design or manufacture of the part. **onsemi** is an Equal Opportunity/Affirmative Action Employer. This literature is subject to all applicable copyright laws and is not for resale in any manner.

ADDITIONAL INFORMATION

TECHNICAL PUBLICATIONS:

Technical Library: www.onsemi.com/design/resources/technical-documentation
onsemi Website: www.onsemi.com

ONLINE SUPPORT: www.onsemi.com/support

For additional information, please contact your local Sales Representative at www.onsemi.com/support/sales