



Product Features

- 1, Constant current output
- 2, High Quality of light
- 3, High Reliability
- 4, Low Output Current Ripple
- 5, Isolated
- 6, Internal usage
- 6, Emergency power: 3W
- 7, Emergency periods: 1.5hrs

1) Compliances and Approvals

Approvals	CE EAC
Built-in/independent	Built in
Ingress protection	IP20
Suitable for fixture of protection Class	Class I
Output Safety Level	Isolated
Enviromental	Indoor
Features	Fixed

2) Electric Input Characteristics

Symbol	Remarks	Min.	Typical	Max.	Unit	
Input Voltage						
Rated mains voltage	Vin	Nominal range	220	-	240	Vac
Mains voltage range	Vin.op	operational	195	-	264	Vac
Mains frequency nominal	fn	Nominal range	50		60	Hz
Rated mains voltage	Vin	Nominal range		-		Vdc
Input Current						
Input current	lin	@230Vac, full load		0.18		A
Input inrush current		@264Vac, 50% width		31.2A,196us		A, us
Power Factor	PF	@230Vac, full load	0.95			
Total Harmonic distortion	THD	@230Vac, full load			20	%
System Efficiency	η	@230Vac, full load		88		%
Input Power						
Input Power	Pin	@230Vac, full load			36	W
Input Power@ open load		rated input voltage			1	W
Input Power@ standby		rated input voltage		NA		

3) Electric Output Characteristics

Symbol	Remarks	Min.	Typical	Max.	Unit	
Output Voltage						
Output voltage range	Vo	measured at end of wire	45		90	Vdc
Output voltage @no load	Vo.max	open load		140		Vdc
Output Current						
Output Current	Io			350		mA
Output Current tolerance			-5		5	%
Current Ripple		@230Vac (Imax-Imin)/(Imax+Imin)		1		%
Output Power	Po	output performance power			32	W
Isolation	In-Out	3000Vac. for 1min			10	mA

4) Emergency Characteristics

Symbol	Remarks	Min.	Typical	Max.	Unit
Emergency Power	@230Vac, full load		3		W
Recharge Time			24		Hours
Emergency Periods			1.5		Hours
Battery	LiFePO4		18650 6.4V 1.5Ah		
Self-testing			Without		

5) Robustness	Symbol	Remarks	Min.	Typical	Max.	Unit
General						
Electric strength	Input-Output	50Hz/60Hz and be applied for 1 min		3000		Vrms
	Input-GND			1480		Vrms
Insulation Resistance Test		500Vd.c. for 1min, For SELV part is 100 Vd.c.	2			MΩ
Reliability						
Rated Life@Tc.max		10% failure			50K	Hrs
Rated Life@Tc.life		10% failure			100K	Hrs
Surge	L-N			1		kV
Surge	L/N-PE			2		kV
Environment Operation						
Ambient temperature	Ta		0		45	°C
Maximum Tcase	Tc.max				75	°C
Tc life	Tc.life				65	°C
Operation Humidity	H.op		10		75	%
Environment Storage						
Storage temperature	T.st		-10		45	°C
Storage Humidity	H.st		10		75	%
Abnormal Condition						
Input Over Voltage		Protected, no damage to driver ^①		Without		Vac
Output Short Circuit		Protected, no damage to driver ^②		With		
Output Open load		Output voltage limited to Vo.max ^③		115		Vdc
Too High Ambient Temperature		Protected by built-in thermal protection in controller IC ^④		With		
Input Over Power		Input power should be limited and no damage to driver ^⑤			36	W

- ① If the LED driver connects to Input Voltage 380Vac, then the protection Turn On and the Led driver is switched off until its connect to Input voltage 220-240Vac.
 In this protection mode, the led driver does not blink and can be not damage more than 48 hours
- ② Auto Recovery
- ③ Auto Recovery
- ④ The output current decreases
- ⑤ There is risk to damage the LED driver or decrases the life time.

6) Warranty

- Warranty 5 years
- Except for the following circumstance:
 - 1) Improper Installation or operation
 - 2) Misuse
 - 3) Abuse
 - 4) Unauthorized or improper repair alteration
 - 5) Accident or negligence in use, storage, transportation.
 - 6) Any natural destroy
 - 7) Exceed the specifiacion as per the product datasheet
 - 8) The battery needs to be replaced every 12 months

7) Mechanical properties	Symbol	Remarks					Unit
Dimensions			L	W	H	M	
			280(A1)	30.5(B1)	23(C1)	269.5(A2)	mm
Housing Material			Metal				

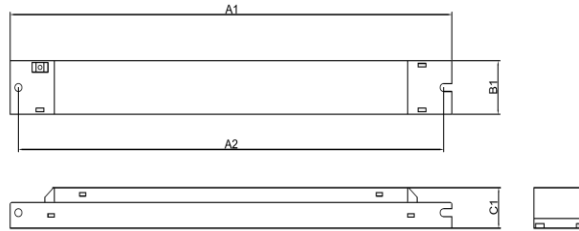

8) Physical properties	Symbol	Remarks					Unit
Weight			212				gram
Qty to Carton			50				pcs
Carton Size:			32.5*29*32				cm
G.W:			12				kgs
Potting Raw materials			without				
Printing		printing can be changed by customer's email confirmation					

size:222*28mm



INPUT <table border="1" style="width: 100%; border-collapse: collapse;"> <tr><td>PE</td><td>Earth</td></tr> <tr><td>L</td><td>Un-Switched Supply</td></tr> <tr><td>LS</td><td>Switched Supply</td></tr> <tr><td>N</td><td>Neutral</td></tr> </table>	PE	Earth	L	Un-Switched Supply	LS	Switched Supply	N	Neutral	 LED Driver PL-HMEM-032WBCC350 220-240Vac 50/60Hz	<table border="1" style="width: 100%; border-collapse: collapse;"> <tr> <th>Uin,Vac</th> <th>Fn,Hz</th> <th>Pin,W</th> <th>Iin,A</th> <th>PF</th> <th>Uout,Vdc</th> <th>Umax,Vdc</th> <th>Iout,mA</th> <th>Ta,°C</th> <th>Tc,°C</th> </tr> <tr> <td>220-240</td> <td>50/60</td> <td>36</td> <td>0.18</td> <td>0.95</td> <td>45-90</td> <td>140</td> <td>350</td> <td>0..45</td> <td>75</td> </tr> </table>	Uin,Vac	Fn,Hz	Pin,W	Iin,A	PF	Uout,Vdc	Umax,Vdc	Iout,mA	Ta,°C	Tc,°C	220-240	50/60	36	0.18	0.95	45-90	140	350	0..45	75	tc:test point ● <table border="1" style="width: 100%; border-collapse: collapse;"> <tr> <td>Battery - LiFePO4</td> <td>6.4 V / 1.5Ah</td> <td>9-10 mm Cable</td> <td>0.5-0.75mm</td> </tr> <tr> <td>Operating time</td> <td>1.5 hour</td> <td></td> <td></td> </tr> <tr> <td>Output power under emergency mode</td> <td>3 W</td> <td></td> <td></td> </tr> </table>	Battery - LiFePO4	6.4 V / 1.5Ah	9-10 mm Cable	0.5-0.75mm	Operating time	1.5 hour			Output power under emergency mode	3 W			<table border="1" style="width: 100%; border-collapse: collapse;"> <tr><td>OUTPUT</td><td>-</td></tr> <tr><td></td><td>+</td></tr> <tr><td>Test Switch</td><td>S</td></tr> <tr><td></td><td>S</td></tr> <tr><td>LED Indicator</td><td>+</td></tr> <tr><td></td><td>-</td></tr> <tr><td>BS</td><td>-</td></tr> <tr><td></td><td>-</td></tr> <tr><td>Battery</td><td>+</td></tr> </table>	OUTPUT	-		+	Test Switch	S		S	LED Indicator	+		-	BS	-		-	Battery	+
PE	Earth																																																													
L	Un-Switched Supply																																																													
LS	Switched Supply																																																													
N	Neutral																																																													
Uin,Vac	Fn,Hz	Pin,W	Iin,A	PF	Uout,Vdc	Umax,Vdc	Iout,mA	Ta,°C	Tc,°C																																																					
220-240	50/60	36	0.18	0.95	45-90	140	350	0..45	75																																																					
Battery - LiFePO4	6.4 V / 1.5Ah	9-10 mm Cable	0.5-0.75mm																																																											
Operating time	1.5 hour																																																													
Output power under emergency mode	3 W																																																													
OUTPUT	-																																																													
	+																																																													
Test Switch	S																																																													
	S																																																													
LED Indicator	+																																																													
	-																																																													
BS	-																																																													
	-																																																													
Battery	+																																																													

Connection		Signal	Cable Description	Remark
Input		PE	0.5-0.75mm ²	grey, push-in terminal
		L	0.5-0.75mm ²	grey, push-in terminal
		LS	0.5-0.75mm ²	grey, push-in terminal
		N	0.5-0.75mm ²	grey, push-in terminal
Output		+	0.5-0.75mm ²	red, push-in terminal
		-	0.5-0.75mm ²	black, push-in terminal

Connection Marking Yes

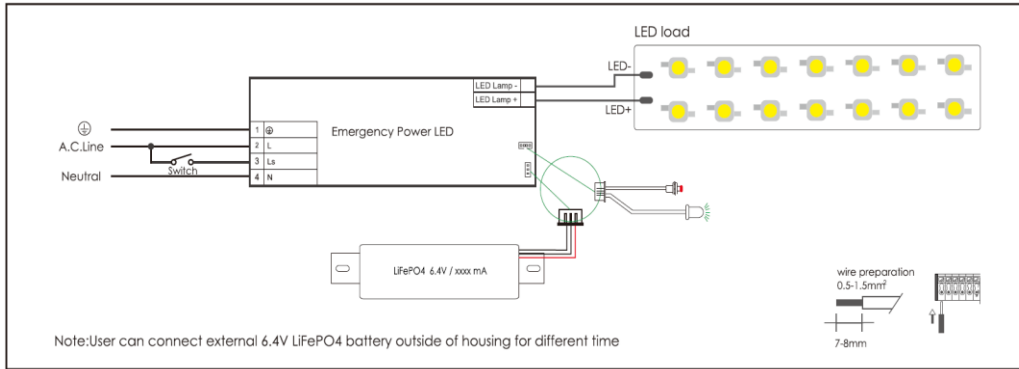
Connection Method

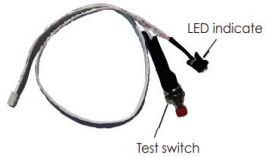

9) Test Switch	Symbol	Remarks	Min.	Typical	Max.	Unit	Unit
LED indicator		indicate that charging status					
Mounting hole		Dia		6.5			mm
wire Length				300			mm
LED indicator status		LED indicate					
		Off: Battery disconnected or mains supply disconnected					
		Green stable: Battery charging or fully charged					
Test Switch		checking the device function					
Mounting hole		Dia		7			mm
wire Length				300			mm

10) Battery	Symbol	Remarks	Unit				
Dimensions			L	W	H	M	
			105(A1)	37(B1)	22(C1)	87(A2)	mm
Weight				95			gram
Qty to Carton				100			pcs
Carton Size:				47*24*16			cm
G.W:				11			kgs

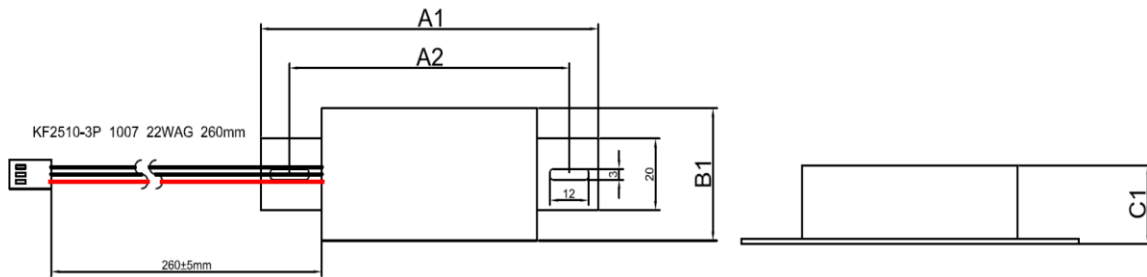

Remark

- LiFePO4 18650 battery core
- Battery voltage 6.4V
- Rated 500 charge/discharge cycle
- Max.short term battery case temperature 70°C (shorter than 1 month over the battery lifetime)
- Ambient temperature 0°C to +50°C
- Two wires: 1 red and 2 black
- Length: 260mm
- The battery needs to be replaced every 12 months
- To guarantee the rated discharge time, please charge the battery for at least more than 12 hours.
- Charge and discharge cycle needs to be done at least once every three months, and the continuous charging time can not exceed 3 months.

11) Directives / Test Standards

Directives / Test Standards

Safety	IEC61347-1、IEC61347-2-7、IEC61347-2-13、IEC60598-2-22
EMC	EN55015、CISPR15、EN61000-3-2、EN61547、EN61000-4-2、EN61000-4-3、EN61000-4-4、EN61000-4-5、EN61000-4-6、EN61000-4-11

12) Addition Remarks

- The LED driver used in combination with the end device is one of the accessories of the whole light fixture, and the EMC of the whole light fixture is not only susceptible to the driver itself, but to the LED light fixture and the whole light fixture's wiring. The manufacturer of LED light fixture should re-confirm the EMC of the whole light fixture before the whole light fixture is finished.
- The luminaire manufacturer is responsible for the correct choice and installation of the LED drivers according to the application and product datasheets. Operating conditions of the LED drivers may never exceed the specifications as per the product datasheet.
- All parameters, if not specified, are measured at 230Vac full loading and 25°C ambient temperature

13) Performance

Lifetime vs. Temperature Curve

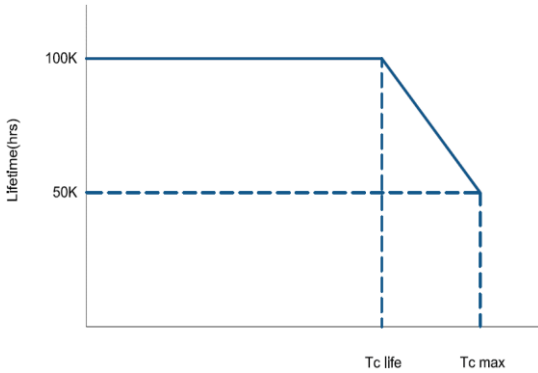

Operating window

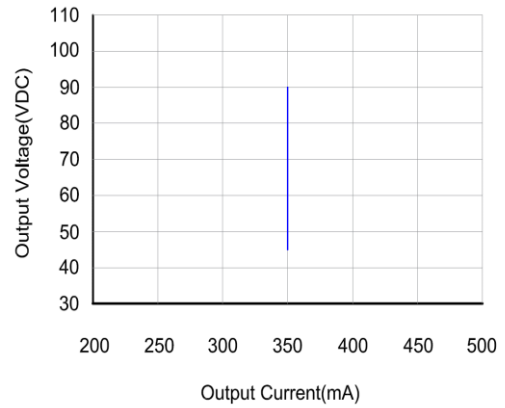

Efficiency VS. Load

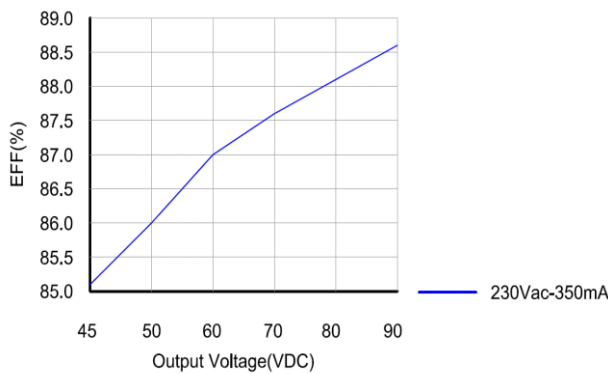

Power Factor Characteristics

