

10-150W Single Output Industrial Power Supplies

<https://product.tdk.com/en/power/hws-a>
www.emea.lambda.tdk.com/hws-a

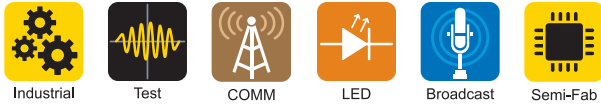

The ultra reliable, conservatively rated HWS-A series of 10W to 150W AC-DC power supplies has a limited lifetime warranty, unique to the industry. The series accepts a wide range 85 to 265Vac (300Vac peak for 5s) input with output voltages from 3.3V to 48V. The products are certified to IEC 62368-1, UL 508 and EN 62477-1 OVC III (HWS150A) and are SEMI F47 compliant . They also meet Class B conducted and radiated emissions without additional filtering or shielding.

Features	Benefits
• Limited Lifetime Warranty	• Low Cost of Ownership
• Very Conservative Electrolytic Capacitor Ratings	• Long Service Life
• Class B Conducted and Radiated EMI	• Easier System EMC Compliance
• Low Off-Load Power Consumption	• Energy Saving
• UL 508 Certified	• Suitable For Industrial Control Equipment

Model Selector								
Model	Output Voltage (V)	Adjustment Range (V)	Maximum Current(A)	Maximum Output Power (W)	Line Reg (mV)	Load Reg (mV)	Overvoltage (V)	Efficiency (115/230Vac)(%)
HWS15A-3/A	3.3	2.97 - 3.96	3	10	20	120	4.13 - 4.95	70 / 71
HWS30A-3/A	3.3	2.97 - 3.96	6	20	20	120	4.13 - 4.95	75 / 77
HWS50A-3/A	3.3	2.97 - 3.96	10	33	20	120	4.13 - 4.95	76 / 78
HWS100A-3/A	3.3	2.97 - 3.96	20	66	20	120	4.13 - 4.95	82 / 84
HWS150A-3/A	3.3	2.97 - 3.96	30	99	20	120	4.13 - 4.95	82 / 84
HWS15A-5/A	5	4.0 - 6.0	3	15	20	120	6.25 - 7.25	77 / 79
HWS30A-5/A	5	4.0 - 6.0	6	30	20	120	6.25 - 7.25	80 / 82
HWS50A-5/A	5	4.0 - 6.0	10	50	20	120	6.25 - 7.25	82 / 84
HWS100A-5/A	5	4.0 - 6.0	20	100	20	120	6.25 - 7.25	84 / 86
HWS150A-5/A	5	4.0 - 6.0	30	150	20	120	6.25 - 7.25	85 / 87
HWS15A-12/A	12	9.6 - 14.4	1.3	16	48	150	15 - 17.4	80 / 83
HWS30A-12/A	12	9.6 - 14.4	2.5	30	48	150	15 - 17.4	84 / 86
HWS50A-12/A	12	9.6 - 14.4	4.3	52	48	150	15 - 17.4	83 / 85
HWS100A-12/A	12	9.6 - 14.4	8.5	102	48	150	15 - 17.4	86 / 88
HWS150A-12/A	12	9.6 - 14.4	13	156	48	150	15 - 17.4	85 / 88
HWS15A-15/A	15	12.0 - 18.0	1	15	60	150	18.8 - 21.8	81 / 84
HWS30A-15/A	15	12.0 - 18.0	2	30	60	150	18.8 - 21.8	85 / 87
HWS50A-15/A	15	12.0 - 18.0	3.5	53	60	150	18.8 - 21.8	83 / 86
HWS100A-15/A	15	12.0 - 18.0	7	105	60	150	18.8 - 21.8	86 / 88
HWS150A-15/A	15	12.0 - 18.0	10	150	60	150	18.8 - 21.8	86 / 89
HWS15A-24/A	24	19.2 - 28.8	0.65	16	96	150	30 - 34.8	82 / 85
HWS30A-24/A	24	19.2 - 28.8	1.3	31	96	150	30 - 34.8	86 / 88
HWS50A-24/A	24	19.2 - 28.8	2.2	53	96	150	30 - 34.8	84 / 87
HWS100A-24/A	24	19.2 - 28.8	4.5	108	96	150	30 - 34.8	87 / 89
HWS150A-24/A	24	19.2 - 28.8	6.5	156	96	150	30 - 34.8	88 / 90
HWS15A-48/A	48	38.4 - 52.8	0.33	16	192	200	55.2 - 64.8	80 / 80
HWS30A-48/A	48	38.4 - 52.8	0.65	31	192	200	55.2 - 64.8	82 / 83
HWS50A-48/A	48	38.4 - 52.8	1.1	53	192	200	55.2 - 64.8	84 / 86
HWS100A-48/A	48	38.4 - 52.8	2.1	101	192	200	55.2 - 64.8	88 / 90
HWS150A-48/A	48	38.4 - 52.8	3.3	158	192	200	55.2 - 64.8	89 / 91

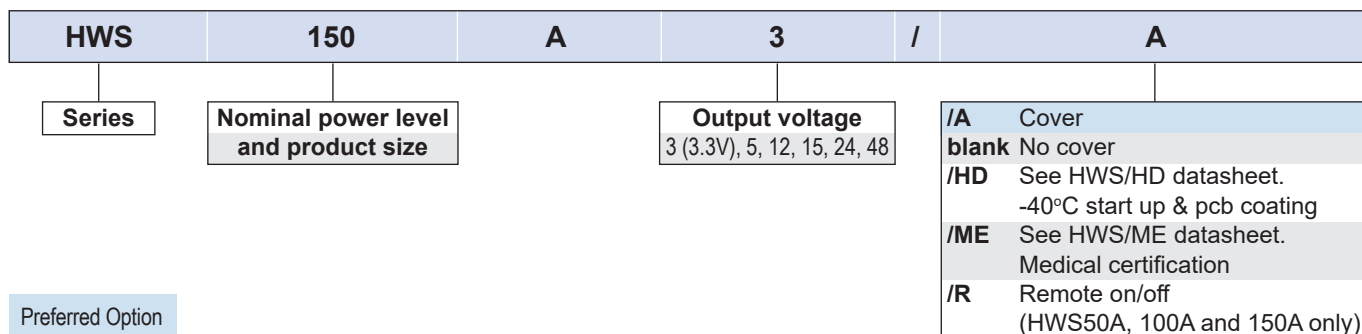

Specifications						
Model		HWS15A	HWS30A	HWS50A	HWS100A	HWS150A
Input						
AC Input Voltage range	Vac	85 - 265				
Input Surge Voltage	-	300Vac for 5s				
Input Frequency	Hz	47 - 63				
DC Input Voltage range*	Vdc	120 - 370				
Input Current (100/200Vac)	A	0.35 / 0.2	0.65 / 0.4	0.65 / 0.35	1.3 / 0.65	1.9 / 0.95
Inrush Current (100/200Vac)	A	14 / 28 (Typical at cold start)				
Leakage Current	uA	>0.5mA (Typically 0.2mA at 100Vac, 0.4mA at 230Vac)				
Power Factor (100/200Vac)	-	-	-	0.97/0.91	0.98/0.93	0.98/0.93
Harmonic Compliance	-	Meets IEC61000-3-2 Class A				
No Load Power Consumption	W	Between 0.3W and 4.6W (model dependent). See evaluation data on website				
Hold Up Time (typ)	ms	20				
Efficiency	-	See Model Selector Table				
Conducted & Radiated EMI	-	EN55011 / EN55032-B, FCC-B, VCCI-B				
Immunity	-	See immunity table				
Safety Certifications and Markings	-	IEC/EN/UL/CSA62368-1, 60950-1, EN50178-1 OVC III (HWS150A only), UL508, CE Mark and UKCA Mark				

Immunity				
Test	Standard	Test Level	Criteria	Notes (See IEC61000 immunity test report on website)
ESD	EN61000-4-2	Air ± 8kV and contact ± 6kV	B	
Radiated Susceptibility	EN61000-4-3	80M -1GHz: 10V/m 1.4 - 2.0GHz: 3V/m 2.0 - 2.7GHz: 1V/m	A	
Electrical Fast Transient Burst	EN61000-4-4	± 2kV	B	
Surge	EN61000-4-5	Normal ± 2kV Common ± 4kV	B	
Conducted Susceptibility	EN61000-4-6	10Vrms	A	
Magnetic Fields	EN61000-4-8	30A/m	A	
Voltage Dips	EN61000-4-11	30% 500ms	A	
		60% 200ms	A	
		100% 20ms	A	
		100% 5000ms	B	
SEMI F47 Line Dip	SEMI F47	-	-	At input voltages > 200Vac

Specifications						
Model		HWS15A	HWS30A	HWS50A	HWS100A	HWS150A
Output						
Switching Frequency	kHz	HWS15A-50A; 100, HWS100A-150A; 120, PFC converter 65				
Line Regulation	mV	See Model Selector Table				
Load Regulation	mV	See Model Selector Table				
External Load Capacitance (Maximum)	uF	3.3V, 5V: 10,000	3.3V, 5V: 10,000		3.3V, 5V: 10,000	
		12V: 5,000, 15V: 2,000	12V, 15V: 5,000		12V, 15V: 10,000	
		24V: 1,000, 48V: 500	24V: 2,000, 48V: 500		24V: 5,000, 48V: 1,000	
Ripple & Noise	mV	3.3V, 5V: 120, 12V, 15V, 24V: 150, 48V: 200				
Temperature Coefficient	%/°C	0.02				
Minimum Load	-	No minimum load required				
Overcurrent Protection	-	HWS15A-50A; >105%. Hiccup with automatic recovery HWS100A-150A; >105%. Constant current and Hiccup with automatic recovery				
Overvoltage Protection	V	See model selector table. Latching (unit shutdown), cycle AC input to reset				
Overtemperature Protection	-	-				
Remote Sense		On HWS100A-150A models only				
Remote On/Off		Optional /R suffix on HWS50A, HWS100A and HWS150A				
Indicators	-	Green LED indicates DC is OK				
Parallel Operation	-	Not possible				
Environmental						
Operating Temperature	°C	HWS15A: -10 to +70, derate linearly to 50% load from 50 to 70				
(Cover models, /A suffix)		HWS30A to 150A: -10 to +70, derate linearly to 20% load from 50 to 70				
Storage Temperature	°C	-30 to +85				
Humidity (non condensing)	%RH	Operating: 30 - 90, Non operating 10 - 95				
Cooling	-	Convection				
Altitude	m	4,000				
Withstand Voltage (For 1 minute)	Vac	Input to ground 2,000, Input to output 3,000, Output to ground 500 for 1 minute				
Isolation Resistance	MΩ	>100 at 25°C, 70%RH & 500Vdc				
Vibration (Non-operating)	-	10-55Hz (Sweep for 1min.)				
		19.6m/s ² Constant X,Y,Z 1 hour each				
Shock (Non-operating)	-	Less than 196m/s ²				
Other						
Weight (Typ)	g	190	240	300	470	520
Size (WxHxD) (with cover /A)	mm	31.5 x 82 x 80	31.5 x 82 x 95	31.5 x 82 x 120	33 x 82 x 160	42 x 82 x 160
Size (WxHxD) (with cover /A)	Inches	1.24 x 3.23 x 3.15	1.24 x 3.23 x 3.74	1.24 x 3.23 x 4.72	1.3 x 3.23 x 6.3	1.65 x 3.23 x 6.3
Connectors	-	Screw terminals				
Case Material	-	Aluminum				
MTBF - Telcordia SR-332 issue 3**		12,116,851	8,169,868	3,726,622	2,963,512	2,676,081
Warranty	yrs	Limited lifetime warranty (See website for terms & conditions)				

Notes

See website for detailed specifications, test methods and installation manual

* Safety certified for AC input only

**24V output model, 55°C ambient, full load, 230Vac input

HWS15A/A Outline Drawing

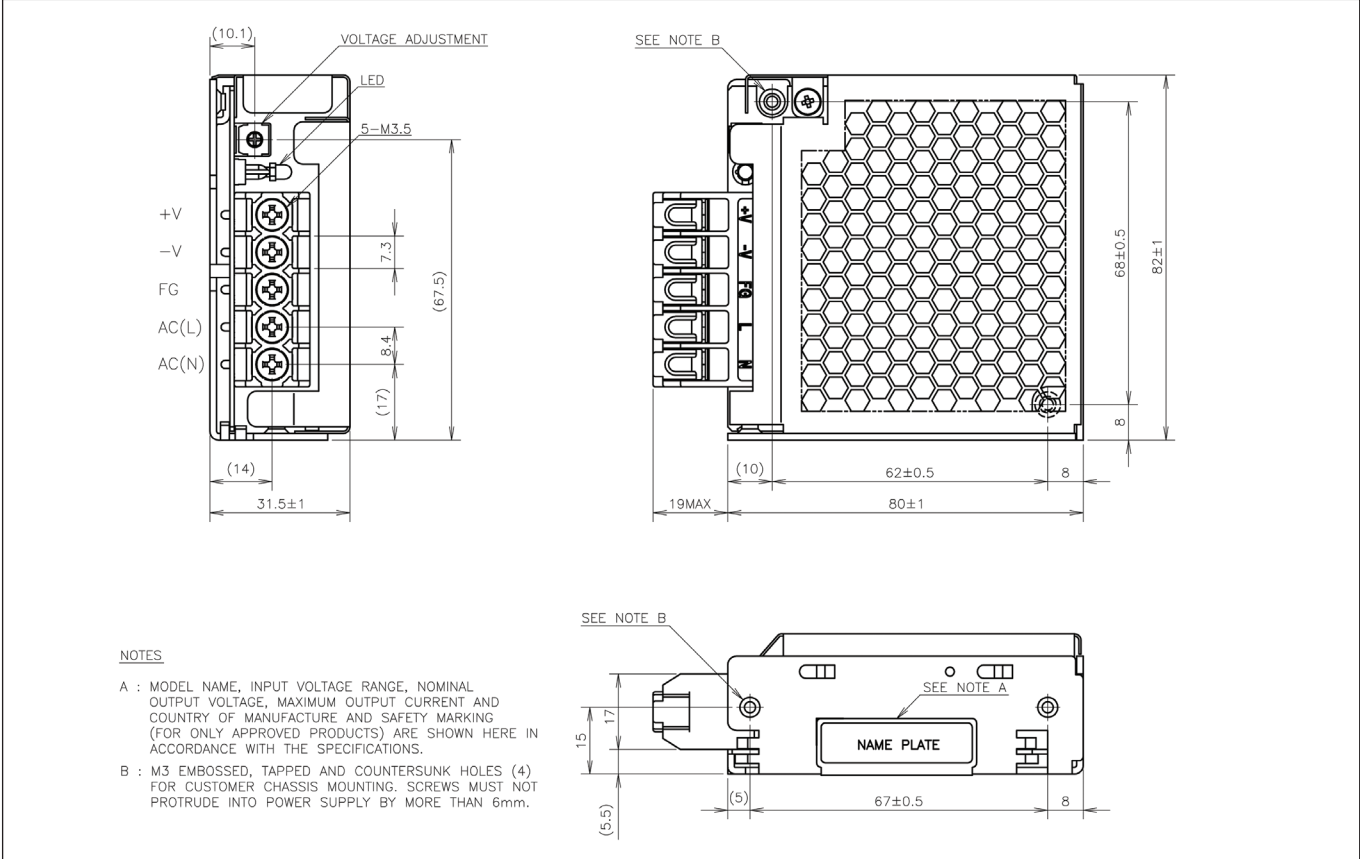

HWS30A/A Outline Drawing

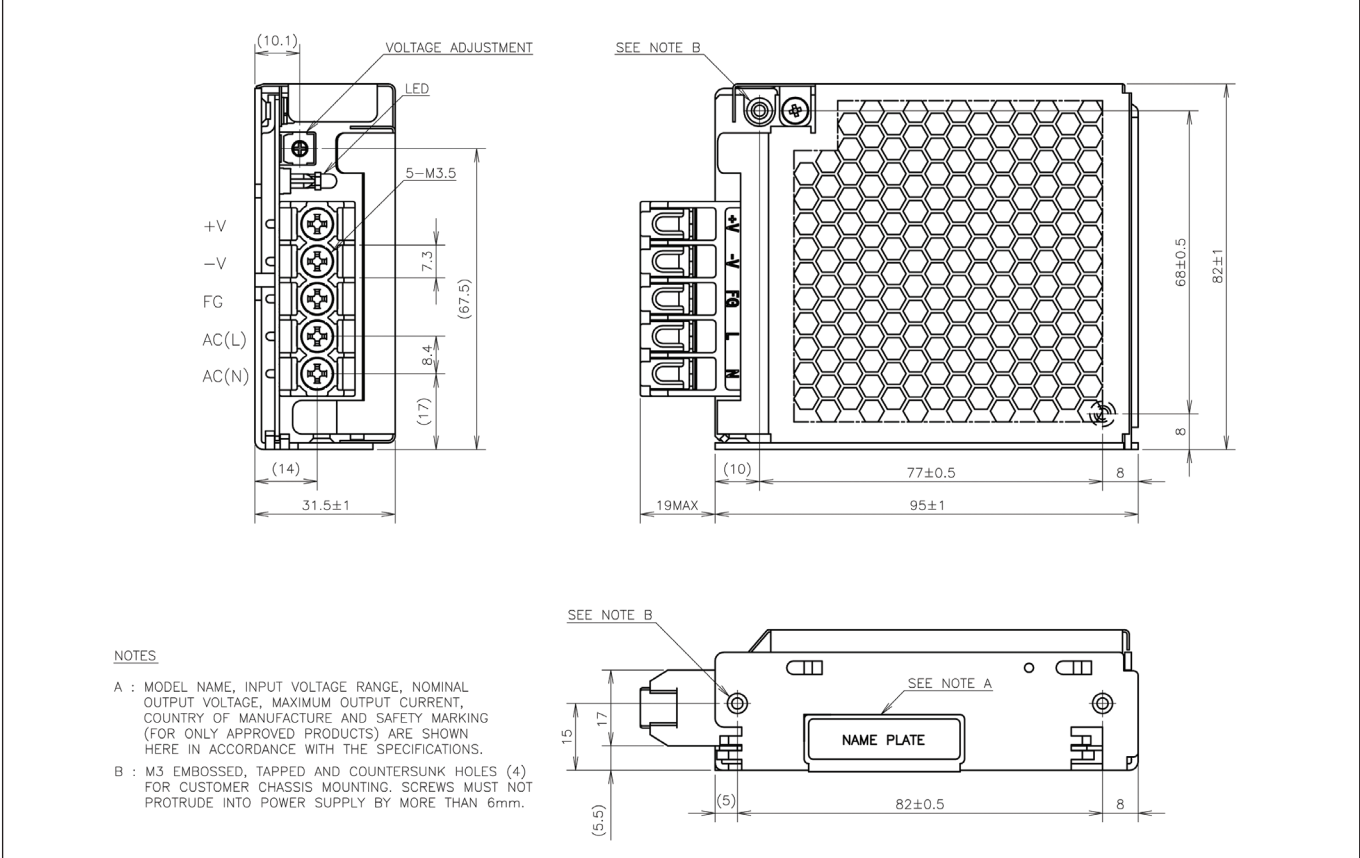

HWS50A/A Outline Drawing

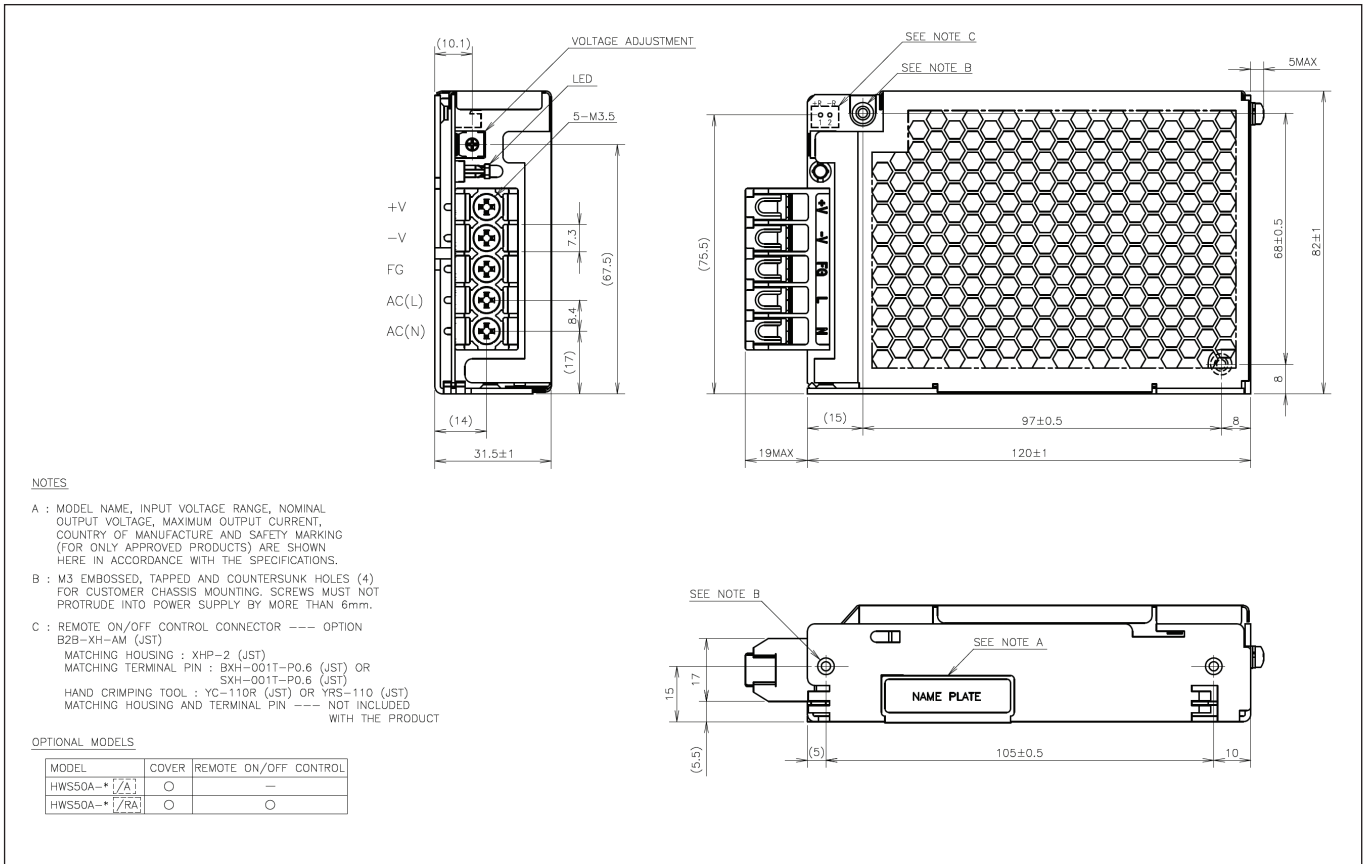

HWS100A/A Outline Drawing

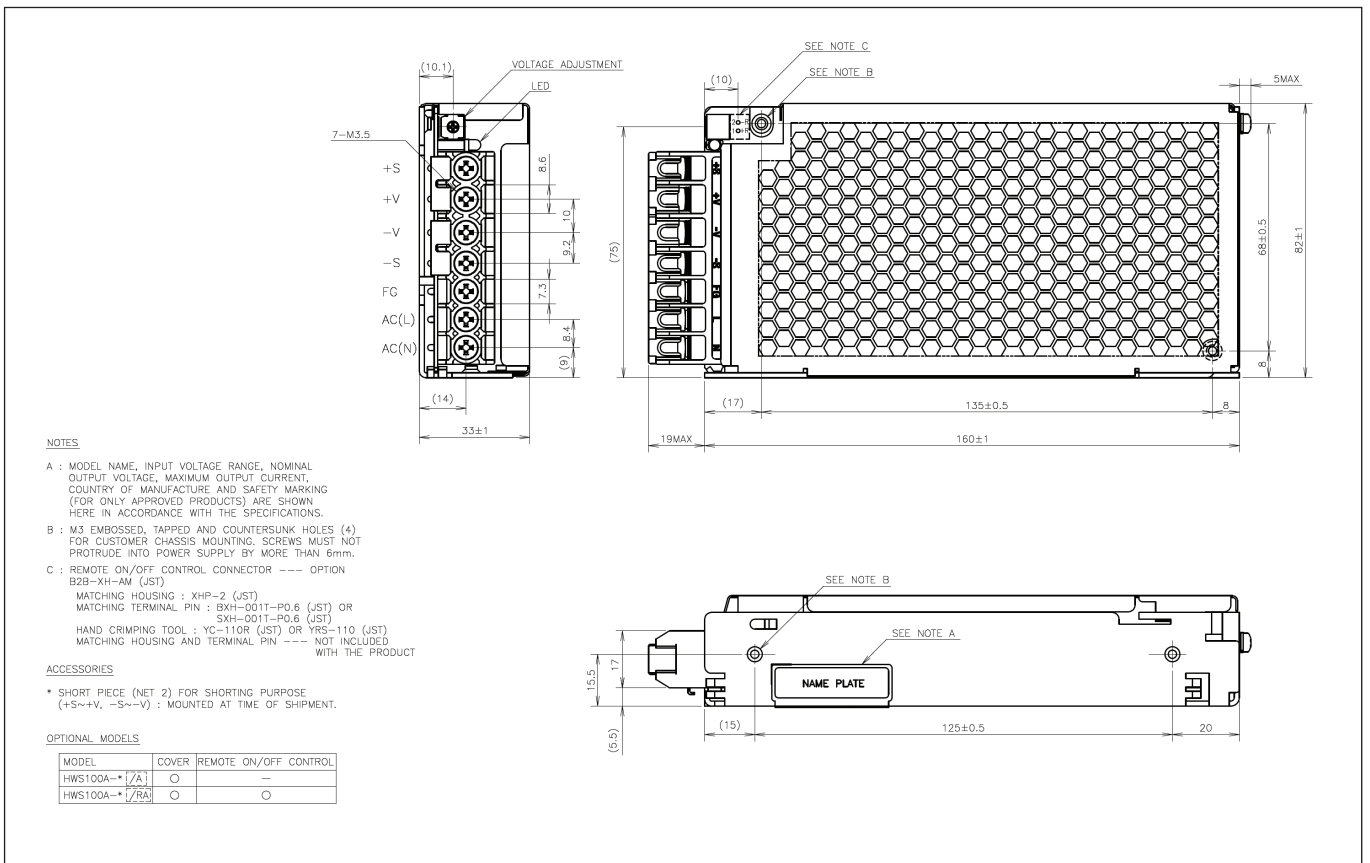

HWS150A/A Outline Drawing

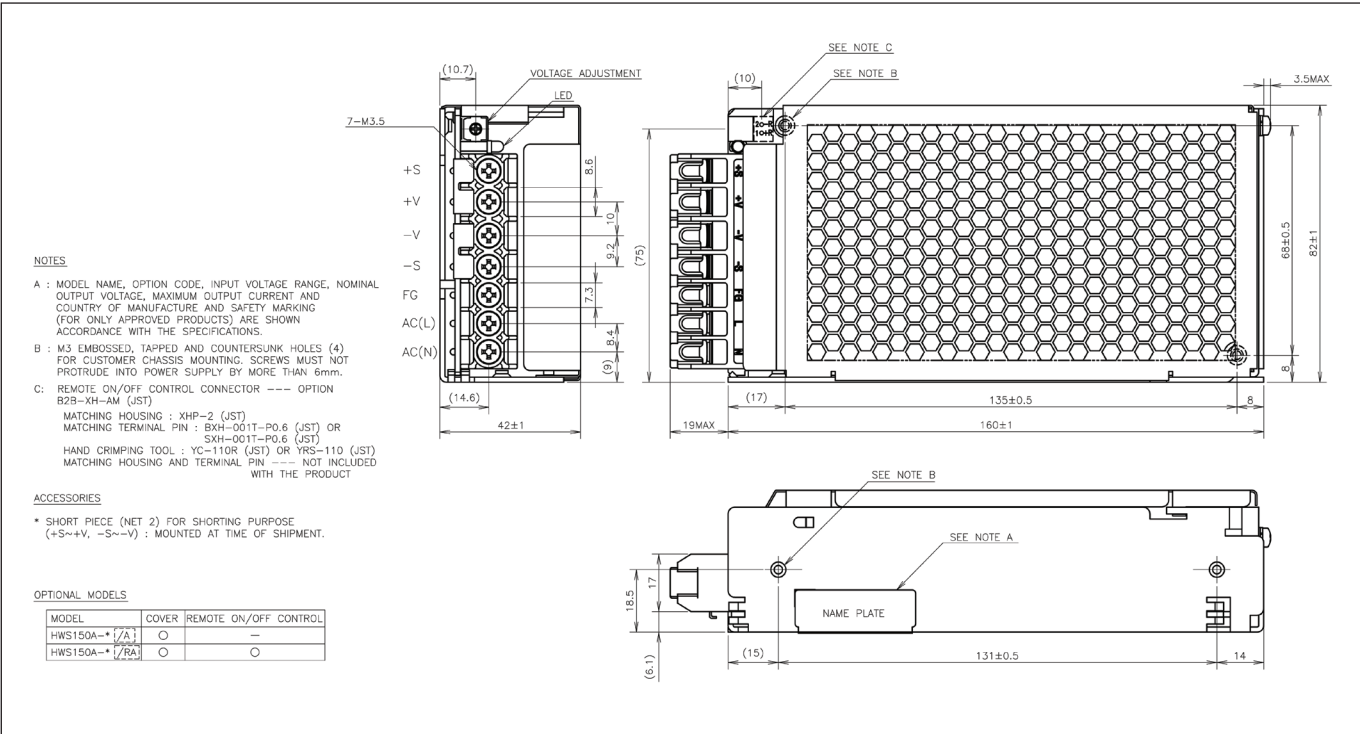



TDK-Lambda France SAS

Tel: +33 1 60 12 71 65
france@fr.tdk-lambda.com
www.emea.lambda.tdk.com/fr



Italy Sales Office

Tel: +39 02 61 29 38 63
info.italia@it.tdk-lambda.com
www.emea.lambda.tdk.com/it



Netherlands

info@nl.tdk-lambda.com
www.emea.lambda.tdk.com/nl



TDK-Lambda Germany GmbH

Tel: +49 7841 666 0
info@de.tdk-lambda.com
www.emea.lambda.tdk.com/de



Austria Sales Office

Tel: +43 2256 655 84
info@at.tdk-lambda.com
www.emea.lambda.tdk.com/at



Switzerland Sales Office

Tel: +41 44 850 53 53
info@ch.tdk-lambda.com
www.emea.lambda.tdk.com/ch



Nordic Sales Office

Tel: +45 8853 8086
info@dk.tdk-lambda.com
www.emea.lambda.tdk.com/dk



TDK-Lambda UK Ltd.

Tel: +44 (0) 12 71 85 66 66
info@uk.tdk-lambda.com
www.emea.lambda.tdk.com/uk



TDK-Lambda Ltd.

Tel: +9 723 902 4333
info@tdk-lambda.co.il
www.emea.lambda.tdk.com/il



C.I.S.

Commercial Support:

Tel: +7 (495) 665 2627

Technical Support:

Tel: +7 (812) 658 0463
info@tdk-lambda.ru
www.emea.lambda.tdk.com/ru



TDK-Lambda Americas

Tel: +1 800-LAMBDA-4 or 1-800-526-2324
powersolutions@us.tdk-lambda.com
www.us.lambda.tdk.com



TDK Electronics do Brasil Ltda

Tel: +55 11 3289-9599
sales.br@tdk-electronics.tdk.com
www.tdk-electronics.tdk.com/en



TDK-Lambda Corporation

Tel: +81-3-6778-1113
www.jp.lambda.tdk.com



TDK-Lambda (China) Electronics Co. Ltd.

Tel: +86 21 6485-0777
powersolutions@cn.tdk-lambda.com
www.lambda.tdk.com.cn



TDK-Lambda Singapore Pte Ltd.

Tel: +65 6251 7211
tts.mkt@sg.tdk-lambda.com
www.sg.lambda.tdk.com



TDK India Private Limited, Power Supply Division

Tel: +91 80 4039-0660
mathew.philip@in.tdk-lambda.com
www.sg.lambda.tdk.com

