

MODEL NO : TM080TDGP01**MODEL VERSION:** 00**SPEC VERSION :** 2.1**ISSUED DATE:** 2019-08-28

- Preliminary Specification
 Final Product Specification

Customer : _____

Approved by	Notes

TIANMA Confirmed :

Prepared by	Checked by	Approved by
Liang_ming	Runnan_kong Huiping_qing Wenyi_li Wei_guo	Guangkun_an

This technical specification is subjected to change without notice

Table of Contents

Table of Contents	2
Record of Revision	3
1 General Specifications	4
2 Input/Output Terminals	5
3 Absolute Maximum Ratings	7
4 Electrical Characteristics	8
5 Timing Chart	11
6 Optical Characteristics	15
7 Environmental / Reliability Test	18
8 Mechanical Drawing	19
9 Packing Drawing	20
10 Precautions for Use of LCD Modules	23

TIANMA CONFIDENTIAL

1 General Specifications

	Feature	Spec
Display Spec.	Size	8 inch
	Resolution	1024RGBx768
	Technology Type	a-Si
	Pixel Configuration	R.G.B. Stripe
	Pixel pitch(mm)	0.158(H) x0.158(V)
	Display Mode	SFT
	Surface Treatment	HC
	Viewing Direction	All
Mechanical Characteristics	LCM (W x H x D) (mm)	183.43x138.35x3.75
	Active Area(mm)	162.05 x 121.54
	With /Without TSP	Without TSP
	Matching Connection Type	ZIF
	LED Numbers	27 LEDS
	Weight (g)	TBD
Electrical Characteristics	Interface	LVDS
	Color Depth	16.7M
	Driver IC	RM51150+HX8684B

Note 1: Viewing direction for best image quality is different from TFT definition. There is a 180 degree shift.

Note 2: Requirements on Environmental Protection: Q/S0002

Note 3: LCM weight tolerance: $\pm 5\%$

2 Input/Output Terminals

Matched connector:FH12A-40S-0.5SH

Pin No.	Symbol	I/O	Function	Remark
1	NC	-	No connection	
2	VDD	P	Power Voltage for digital circuit	
3	VDD	P	Power Voltage for digital circuit	
4	NC	---	No connection	
5	RESET	I	Global reset pin	
6	STBYB	I	Standby mode, Normally pulled high STBYB = "1", normal operation STBYB = "0", timing controller, source driver will turn off, all output are GND	
7	GND	P	Ground	
8	RXIN0-	I	- LVDS differential data input	
9	RXIN0+	I	+ LVDS differential data input	R[0]~G[0]
10	GND	P	Ground	
11	RXIN1-	I	- LVDS differential data input	
12	RXIN1+	I	+ LVDS differential data input	G[1]~B[1]
13	GND	P	Ground	
14	RXIN2-	I	- LVDS differential data input	
15	RXIN2+	I	+ LVDS differential data input	DE/VS/HS/ B[2]~B[5]
16	GND	P	Ground	
17	RXCLKIN-	I	- LVDS differential clock input	
18	RXCLKIN +	I	+ LVDS differential clock input	
19	GND	P	Ground	
20	RXIN3-	I	- LVDS differential data input	
21	RXIN3+	I	+ LVDS differential data input	R[6]/R[7]/G[6]/G[7]/B[6]/B[7]
22	GND	P	Ground	
23	NC	---	No connection	
24	NC	---	No connection	
25	GND	P	Ground	
26	NC	---	No connection	
27	DIMO	O	Backlight CABC controller signal output	Note1
28	SELB	I	6bit/8bit mode select Pin	Note2
29	AVDD	P	Power for Analog Circuit	
30	GND	P	Ground	
31	LED-	P	LED Cathode	
32	LED-	P	LED Cathode	
33	L/R	I	Horizontal Scanning direction setting	Note3
34	U/D	I	Vertical Scanning direction setting	Note3
35	VGL	P	Gate OFF Voltage	
36	CABCEN1	I	CABC H/W enable pin	Note4
37	CABCEN0	I	CABC H/W enable pin	Note4

The information contained herein is the exclusive property of TIANMA MICRO-ELECTRONICS Corporation and shall not be distributed, reproduced, or disclosed in whole or in part without prior written permission of TIANMA MICRO-ELECTRONICS Corporation.

38	VGH	P	Gate ON Voltage	
39	LED+	P	LED Anode	
40	LED+	P	LED Anode	

I/O----definition, I----Input, O----Output, P----Power, No used I/O pin please fix to GND level

Note1: PWM output after CABC function;

Note2: LVDS mode 6bits/8bits input select pin,If LVDS input data in 6 bits,SELB must be set To high,If LVDS input data in 8 bits,SELB must be set to low,

Note3: When L/R="0",set right to left scan direction, L/R="1" set left to right scan direction
When U/D="0",set top to bottom scan direction, U/D="1" set bottom to top scan direction

Note4:

CABC_EN[1:0]	I	<p>CABC H/W enable pin. Normally pull low. When CABC_EN="00", CABC off. (Default mode) When CABC_EN="01", user interface Image. When CABC_EN="10", still Picture. When CABC_EN="11", moving Image.</p>
--------------	---	--

TIANMA CONFIDENTIAL

3 Absolute Maximum Ratings

GND=0V

Item	Symbol	MIN	MAX	Unit	Remark
Power Voltage	VDD	-0.3	5.0	V	Note1
Power Supply Voltage 2	AVDD	-0.5	13.5	V	Base on IC Spec
Power Supply Voltage 3	VGH	-0.3	+42	V	Base on IC Spec
Power Supply Voltage 4	VGL	VGH-42	+0.3	V	Base on IC Spec
Operating Temperature	Top	-20	70	°C	
Storage Temperature	Tst	-30	80	°C	
Relative Humidity Note2	RH	--	≤95	%	Ta≤40°C
		--	≤85	%	40°C < Ta ≤ 50°C
		--	≤55	%	50°C < Ta ≤ 60°C
		--	≤36	%	60°C < Ta ≤ 70°C
		--	≤24	%	70°C < Ta ≤ 80°C
Absolute Humidity	AH	--	≤70	g/m ³	Ta > 70°C

Table 3 Absolute Maximum Ratings

Note1: Input voltage include RESET , STBYB ,SELB , L/R ,U/D, CABCE1, CABCE0.

Note2: Ta means the ambient temperature.

It is necessary to limit the relative humidity to the specified temperature range.
Condensation on the module is not allowed.

4 Electrical Characteristics

4.1 Recommended Operating Condition

AGND=GND=0V, Ta = 25°C

Item	Symbol	Min	Typ.	Max	Unit	Remark
Digital Supply Voltage	VDD	3.0	3.3	3.6	V	-
Analog Supply Voltage	AVDD	12.4	12.6	12.8	V	-
Gate On Voltage	VGH	22.0	23.0	24.0	V	-
Gate Off Voltage	VGL	-7.5	-7.0	-6.5	V	-

4.2 Power Consumption

AGND=GND=0V, Ta = 25°C

Item	Symbol	Condition	Min	Typ.	Max	Unit	Remark
Digital Supply Current	I _{VCC}	VDD=3.3V	-	TBD	-	mA	-
Analog Supply Current	I _{AVDD}	AVDD=12.6V	-	TBD	-	mA	-
Gate On Current	I _{VGH}	VGH=23.0V	-	TBD	-	mA	-
Gate Off Current	I _{VGL}	VGL=-7.0V	-	TBD	-	mA	-
Power Consumption	Pane I& Gamma		-	TBD	-	mW	-

Note1: Checkered Black pattern for Typ.

4.3 Recommended Driving Condition for Backlight

Ta=25°C

Item	Symbol	Min	Typ	Max	Unit	Remark
Forward Current	I_F	-	180	225	mA	27LEDs (3 LED Serial, 9 LED Parallel)
Forward Voltage	V_F	8.4	9.3	10.2	V	
Backlight Power Consumption	W_{BL}	-	1.674	2.295	W	
Operating Life Time	-	20,000	30,000	-	Hrs	$I_F = 20\text{mA}$

Note1: The LED driving condition is defined for each LED module (3 LED Serial, 9 LED Parallel). For each LED: $I_F (1/9) = 20\text{mA}$, $V_F (1/3) = 3.1\text{V}$.

Note2: Under LCM operating, the stable forward current should be inputted. And forward voltage is for reference only.

Note3: I_F is defined for one channel LED. Optical performance should be evaluated at Ta=25°C only. If LED is driven by high current, high ambient temperature & humidity condition. The life time of LED will be reduced. Operating life means brightness goes down to 50% initial brightness. Typical operating life time is estimated data.

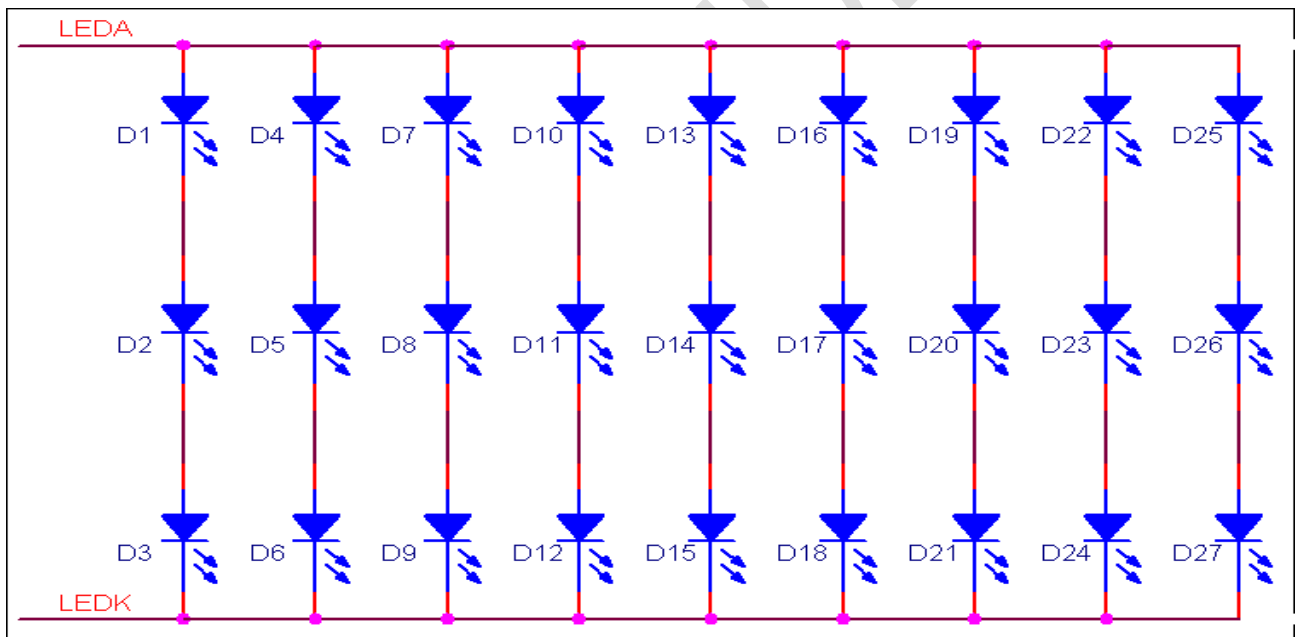

Note4: The LED driving condition is defined for each LED module

4.4 Block Diagram

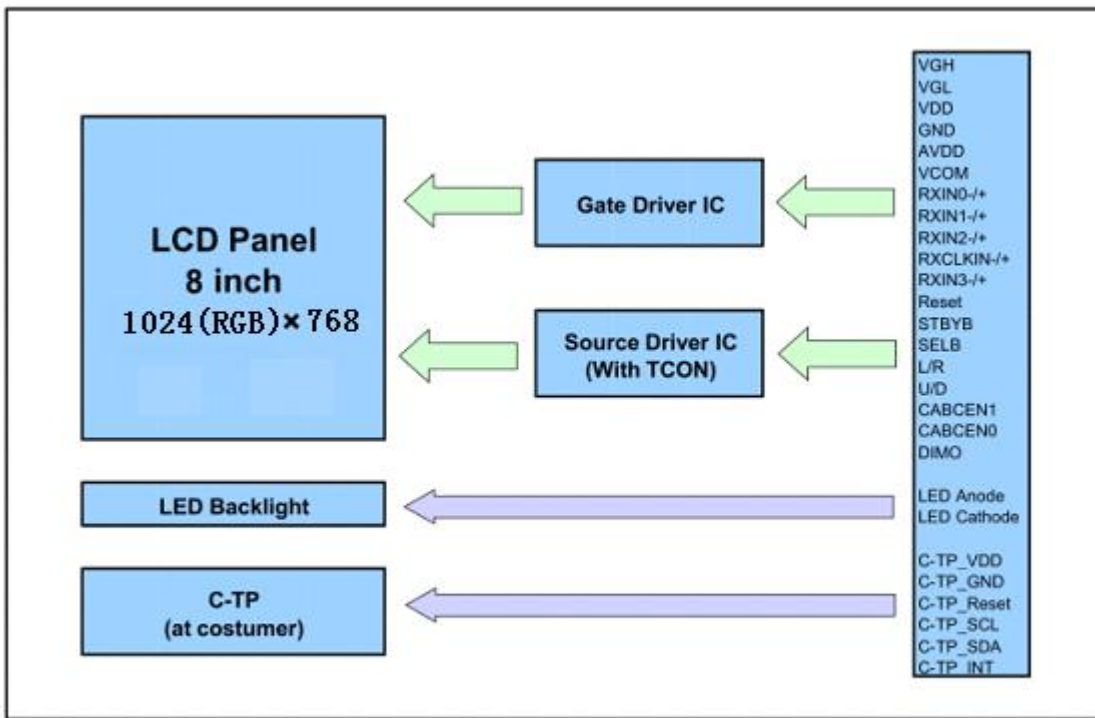

LCD module diagram

5 Timing Chart

5.1 LVDS mode DC electrical characteristics

Parameter	Symbol	Min.	Typ.	Max.	Unit	Condition
Differential Input high Threshold voltage	R_{xVTH}	-	-	+0.2	V	$R_{xVCM}=1.2V$
Differential Input Low Threshold voltage	R_{xVTL}	-0.2	-	-	V	
Input voltage range (signaled-end)	R_{xVIN}	0	-	$VDD-1.2$	V	-
Differential Input common Mode voltage	R_{xVCM}	$ V_{ID} /2$	-	$VDD-1.2- V_{ID} /2$	V	-
Differential Input voltage	$ V_{ID} $	0.2	-	0.6	V	-
Differential Input leakage Current	R_{xIILZ}	-10	-	+10	μA	-
LVDS Digital Operating Current	I_{ddlvds}	-	15	30	mA	Fclk=65MHz, VDD=3.3V
LVDS Digital Stand-by Current	I_{stlvds}	-	10	50	μA	Clock & all functions are stopped

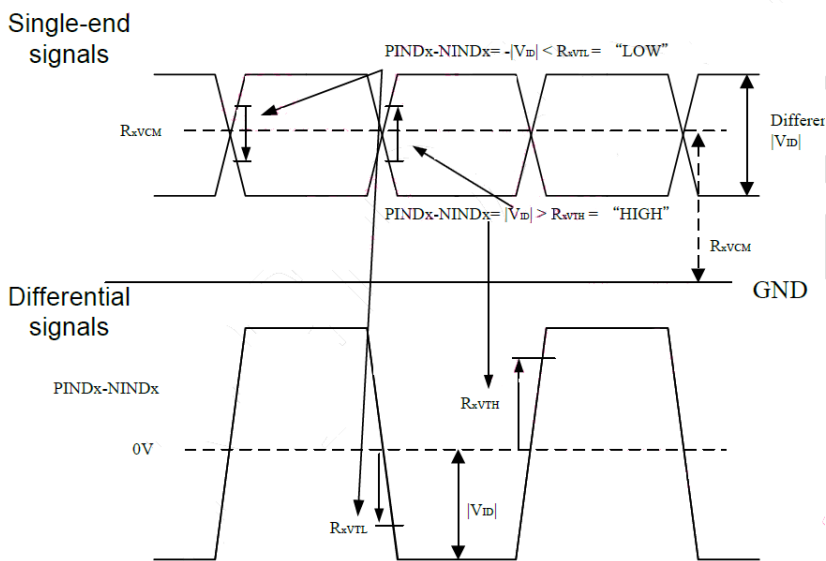

5.2 LVDS mode AC electrical characteristics

Parameter	Symbol	Min.	Typ.	Max.	Unit	Condition
Clock frequency	R _X FCLK	20	-	71	Mhz	
Input data skew margin	T _{RSKM}	-	-	500	ps	V _{ID} =400mV R _{XVCM} =1.2V R _X FCLK=71MHz
Clock high time	T _{LVCH}	-	4/(7*R _X FCLK)	-	ns	
Clock low time	T _{LVCL}	-	3/(7*R _X FCLK)	-	ns	
PLL wake-up time	T _{emPLL}	-	-	150	us	

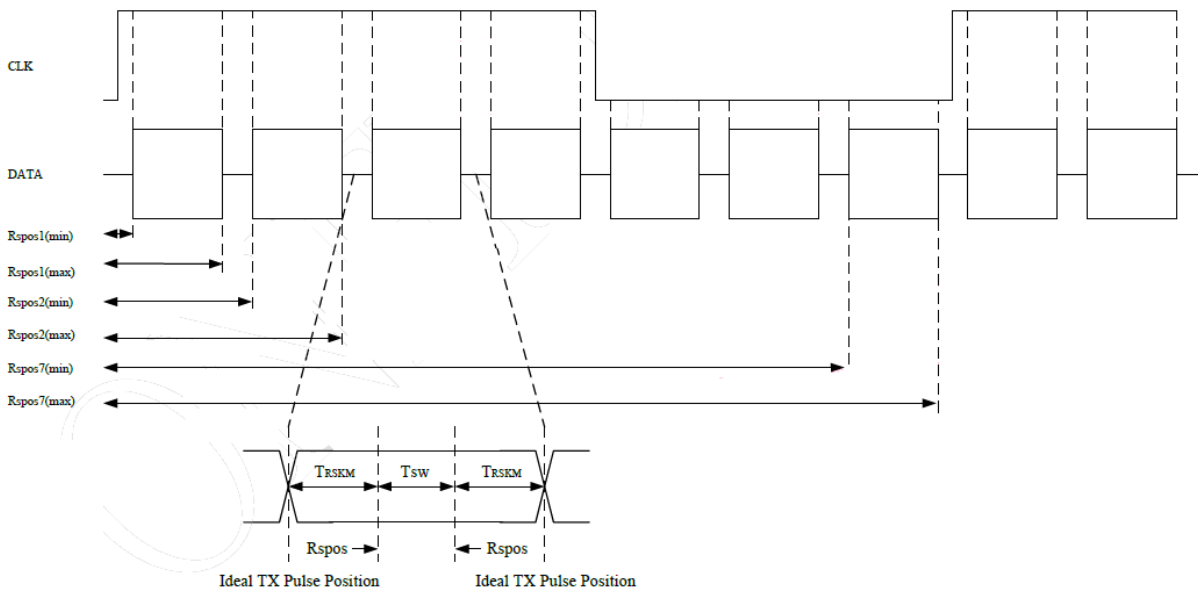
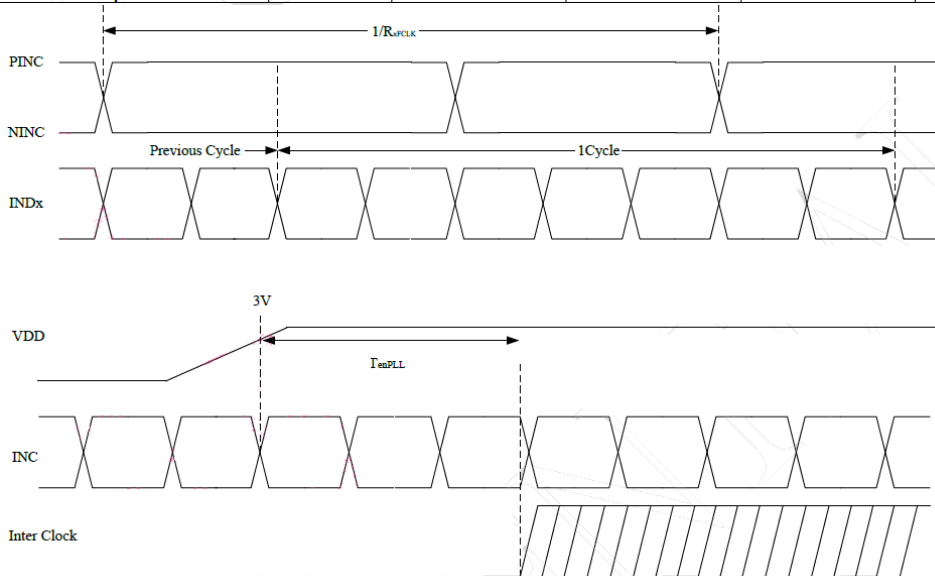

T_{RSKM} : Receiver strobe margin
 R_{spos} : Receiver strobe position
 T_{sw} : Strobe width (internal data sampling window)

Parameter	Symbol	Min.	Typ.	Max.	Unit	Condition
Modulation Frequency	SSC _{MF}	23	-	93	KHz	
Modulation Rate	SSC _{MR}	-	-	±3	%	LVDS clock = 71MHz center spread

The information contained herein is the exclusive property of TIANMA MICRO-ELECTRONICS Corporation and shall not be distributed, reproduced, or disclosed in whole or in part without prior written permission of TIANMA MICRO-ELECTRONICS Corporation.

5.3 Data input format

5.3.1 LVDS data mapping

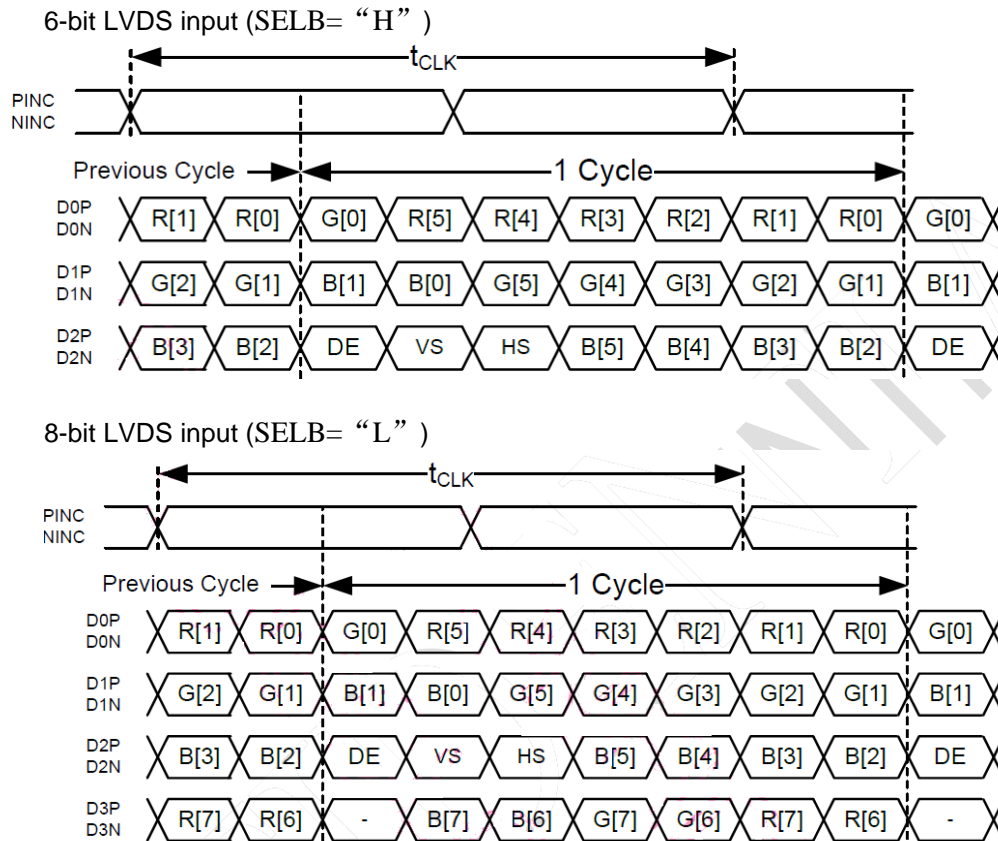

5.3.2 Parallel RGB input timing table

DE mode

Parameter	Symbol	Value			Unit
		Min.	Typ.	Max.	
DCLK Frequency	fclk	52	65	71	MHz
Horizontal Display Area	thd	1024			DCLK
HSD Period	th	1114	1344	1400	DCLK
HSD Blanking	thb+thfp	90	320	376	DCLK
Vertical Display Area	tvd	768			T _H
VSD Period	tvbp	778	806	845	T _H
VSD Blanking	tvbp+tvfp	10	38	77	T _H

5.4 Power ON/OFF Sequence

Item	Symbol	MIN	Typ	MAX	Unit	Remark
VDD on to Reset signal	T1	1	-	-	ms	
Reset to Standby off	T2	0	-	-	ms	
Standby off to Display signal on	T3	1	-	-	ms	
Display signal to AVDD on	T4	33.2	-	-	ms	
AVDD on to VGL on	T5	16.6	-	-	ms	
VGL on to VGH on	T6	16.6	-	-	ms	
VGH on to B/L on	T7	200	-	-	ms	
B/L off to Standby on	T8	500	-	-	ms	
Standby on to VGL off	T9	33.2	-	-	ms	
VGL off to VGH off	T10	16.6	-	-	ms	
VGH off to AVDD off	T11	16.6	-	-	ms	
AVDD off to Display signal off	T12	16.6	-	-	ms	
Display signal off to VDD and Reset off	T13	16.6	-	-	ms	

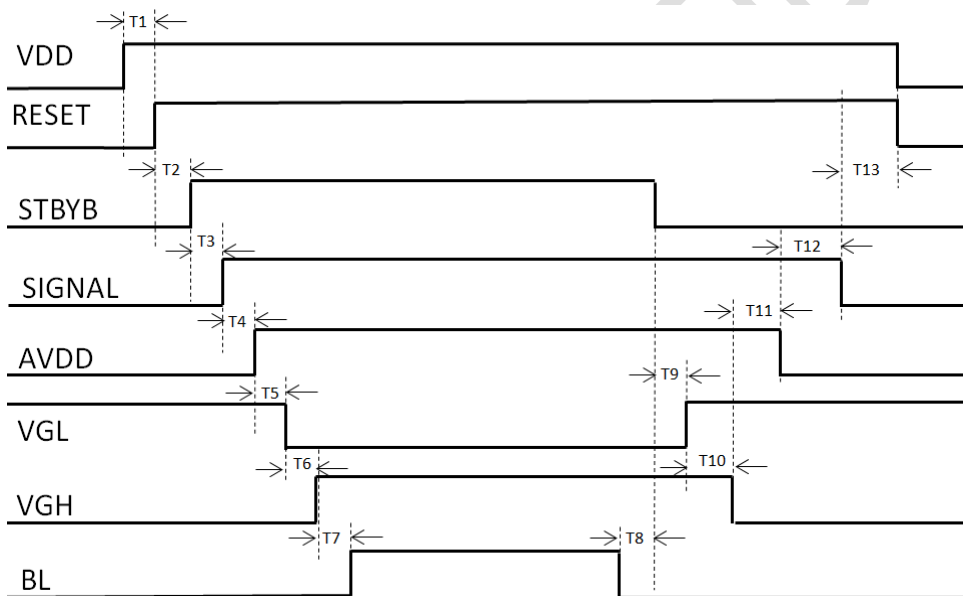

6 Optical Characteristics

Item	Symbol	Condition	Min	Typ	Max	Unit	Remark
View Angles	θT	$CR \geq 10$	75	85	-	Degree	Note2,3
	θB		75	85	-		
	θL		75	85	-		
	θR		75	85	-		
Contrast Ratio	CR	$\theta=0^\circ$	1500	1800	-		Note 3
Response Time	T_{ON}	25°C	-	35	45	ms	Note 4
	T_{OFF}						
Chromaticity	White	Backlight is on	x	0.251	0.310	0.351	Note 1,5
			y	0.279	0.329	0.379	
	Red		x	0.537	0.587	0.637	Note 1,5
			y	0.280	0.330	0.380	
	Green		x	0.308	0.358	0.408	Note 1,5
			y	0.536	0.586	0.636	
	Blue		x	0.106	0.156	0.206	Note 1,5
			y	0.048	0.098	0.148	
Uniformity	U		80	85		%	Note 6
NTSC			45	50		%	Note 5
Luminance	L		400	450		cd/m ²	Note 7

Test Conditions:

1. IF= 180 mA, and the ambient temperature is 25°C.
2. The test systems refer to Note 1 and Note 2.

Note 1: Definition of optical measurement system.

The optical characteristics should be measured in dark room. After 5 Minutes operation, the optical properties are measured at the center point of the LCD screen. All input terminals LCD panel must be ground when measuring the center area of the panel.

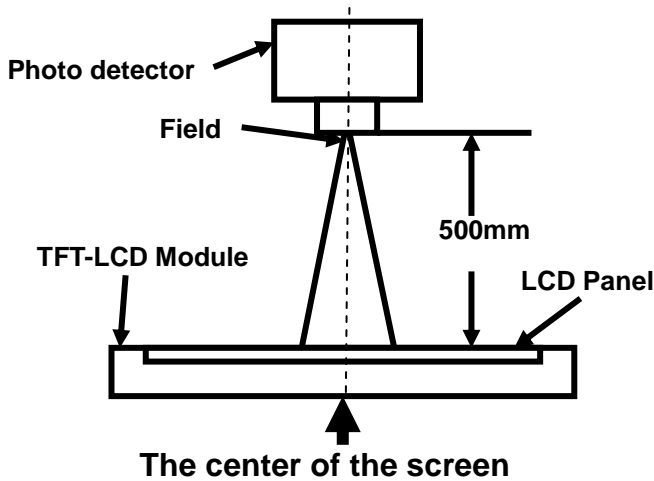

Note 2: Definition of viewing angle range and measurement system.

viewing angle is measured at the center point of the LCD.

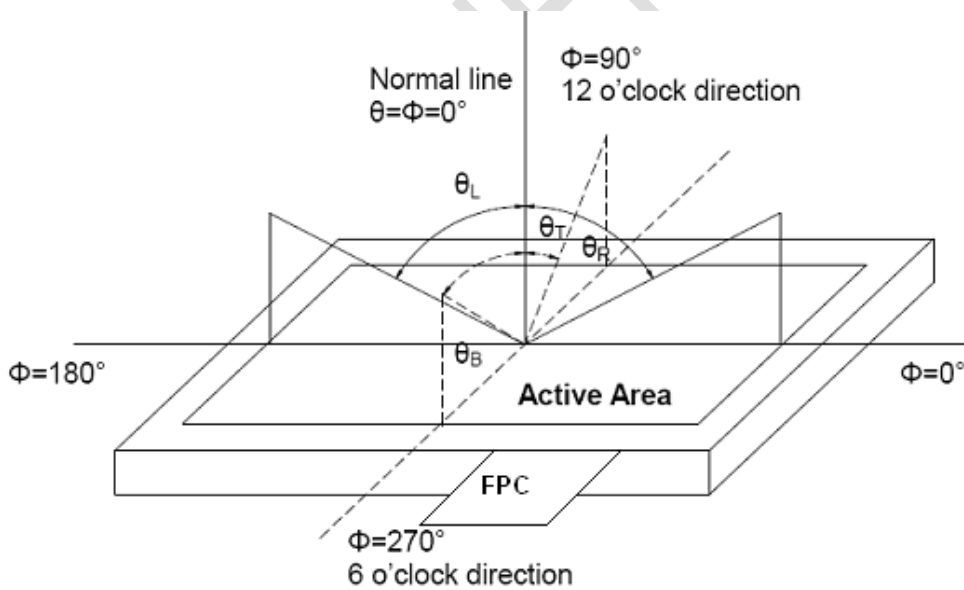

Note 3: Definition of contrast ratio

$$\text{Contrast ratio (CR)} = \frac{\text{Luminance measured when LCD is on the "White" state}}{\text{Luminance measured when LCD is on the "Black" state}}$$

“White state “: The state is that the LCD should drive by V_{white} .

“Black state”: The state is that the LCD should drive by V_{black} .

V_{white} : To be determined V_{black} : To be determined.

The information contained herein is the exclusive property of TIANMA MICRO-ELECTRONICS Corporation and shall not be distributed, reproduced, or disclosed in whole or in part without prior written permission of TIANMA MICRO-ELECTRONICS Corporation.

Note 4: Definition of Response time

The response time is defined as the LCD optical switching time interval between “White” state and “Black” state. Rise time (T_{ON}) is the time between photo detector output intensity changed from 90% to 10%. And fall time (T_{OFF}) is the time between photo detector output intensity changed from 10% to 90%.

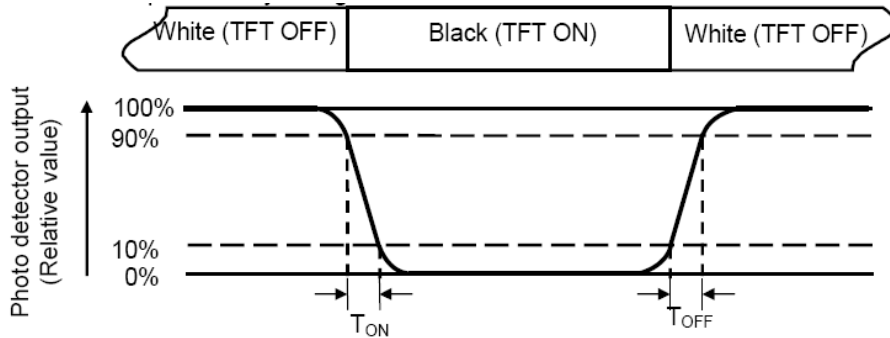

Note 5: Definition of color chromaticity (CIE1931)

Color coordinates measured at center point of LCD.

Note 6: Definition of Luminance Uniformity

Active area is divided into 9 measuring areas (Refer Fig. 2). Every measuring point is placed at the center of each measuring area.

$$\text{Luminance Uniformity (U)} = L_{\min} / L_{\max}$$

L-----Active area length W----- Active area width

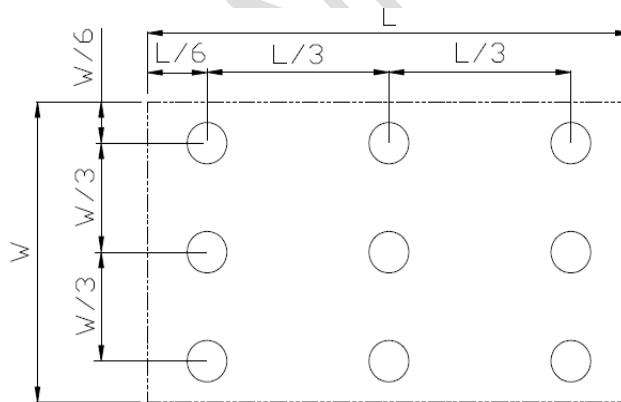

L_{\max} : The measured Maximum luminance of all measurement position.

L_{\min} : The measured Minimum luminance of all measurement position.

Note 7: Definition of Luminance:

Measure the luminance of white state at center point.

7 Environmental / Reliability Test

No	Test Item	Condition	Remarks
1	High Temperature Operation	Ta = +70°C, 240 hours (Note1)	IEC60068-2-1:2007 GB2423.2-2008
2	Low Temperature Operation	Ta = -20°C, 240 hours (Note2)	IEC60068-2-1:2007 GB2423.1-2008
3	High Temperature Storage	Ta = +80°C, 240 hours	IEC60068-2-1:2007 GB2423.2-2008
4	Low Temperature Storage	Ta = -30°C, 240 hours	IEC60068-2-1:2007 GB2423.1-2008
5	Storage at High Temperature and Humidity	Ta = +60°C, 90% RH max, 240hours	IEC60068-2-78 :2001 GB/T2423.3—2006
6	Thermal Shock (non-operation)	-30°C 30 min ~ +80°C 30 min, Change time:5min, 100 Cycle	Start with cold temperature, End with high temperature, IEC60068-2-14:1984,G B2423.22-2002
7	ESD	C=150pF, R=330Ω, 5point/panel Air: ±8Kv, 5times; Contact: ±4Kv, 5times (Environment: 15°C~35°C, 30%~60%. 86Kpa~106Kpa)	IEC61000-4-2:2001 GB/T17626.2-2006
8	Vibration Test	5Hz~20Hz~200Hz , 0.01g2/Hz~0.01g2/Hz~0.001g2/Hz , X/Y/Z 各轴 30min	GB/T 4857.23-2012
9	Package Drop Test	Drop 1 corner, 3 edges, 6 surfaces from height of 80cm (Weight ≤10kg); of 60 cm (Weight>10kg)	GB/T 4857.5-1992

Note1: Ta is the ambient temperature of sample.

Note2: Before cosmetic and function test, the product must have enough recovery time, at least 24 hours at room temperature.

Note 3: In the standard condition, there shall be no practical problem that may affect the display function. After the reliability test, the product only guarantees operation, but don't guarantee all of the cosmetic specification.

8 Mechanical Drawing

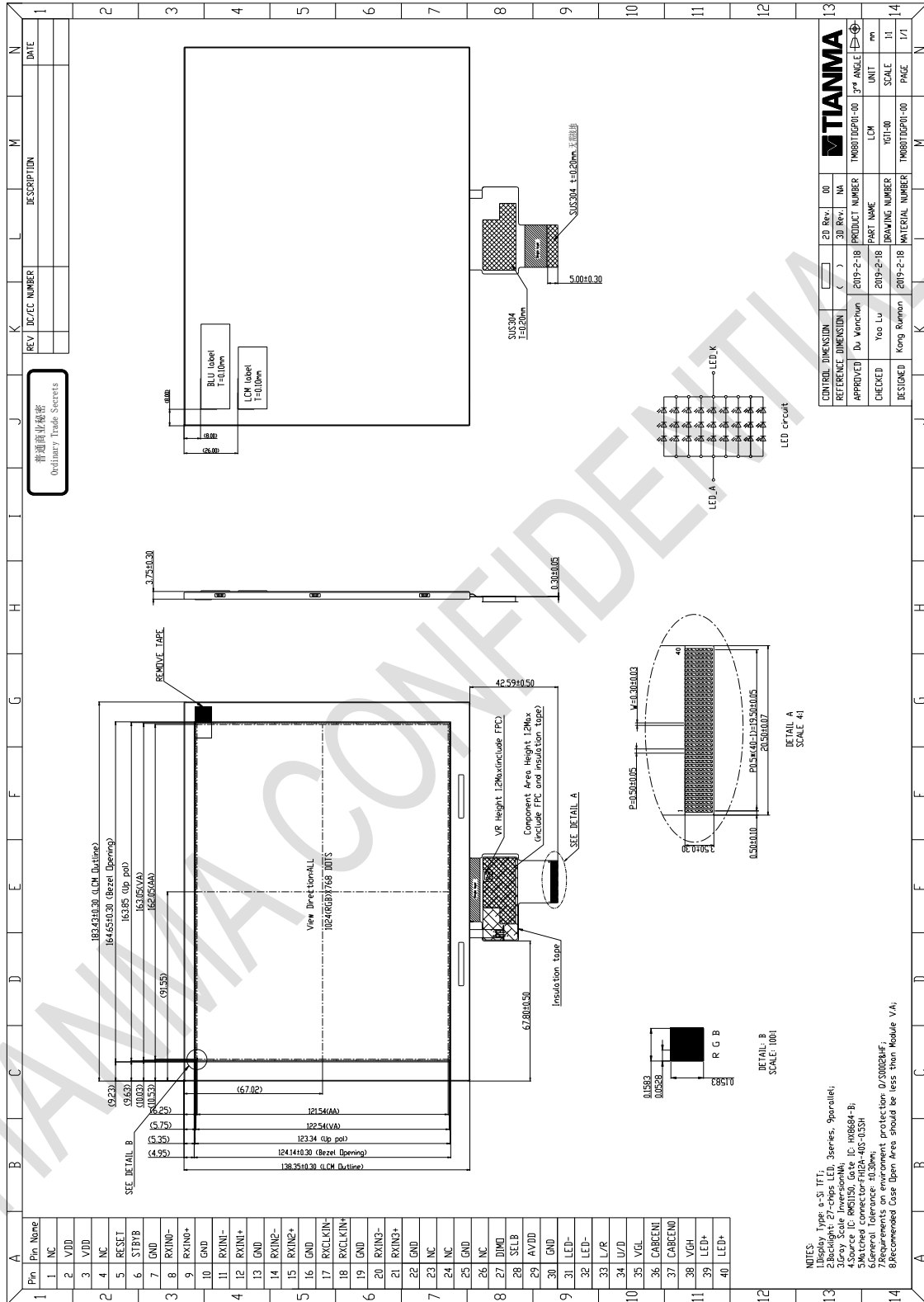

The information contained herein is the exclusive property of TIANMA MICRO-ELECTRONICS Corporation and shall not be distributed, reproduced, or disclosed in whole or in part without prior written permission of TIANMA MICRO-ELECTRONICS Corporation.

9 Packing Drawing

9.1 Packaging Material

Per Carton

No	Item	Model (Material)	Dimensions(mm)	Unit Weight(Kg)	Quantity	Remark
1	LCM module	TM080TDGP01-00	183.43×138.35×3.75	0.180	36	
2	Tray	PET	485×330×1.0	0.18	21	
3	Dust-proof Bag	PE	700×545×0.05	0.021	1	
4	Carton	Corrugated Paper	544×365×250	1.01	1	
5	BOX	Corrugated Paper	520×345×74	0.227	3	
6	Label	paper	100×52	0.001	1	
7	EPE	EPE	485×330×5	0.05	3	
8	Total weight			12.1		

9.2 Packing instruction

Use empty tray
使用一个空吸塑盘做盖子

+

Put products into the
6trays*2 LCMS per tray.
将产品放入6个吸塑盘中，每个吸塑盘中放入2
片模组



Use strop
如右图方式打包吸塑盘组



put LEM into little
box, 7tray with 12LCM for
every box
将模组放置到包装盒中，每盒装
7tray, 12pcs 模组

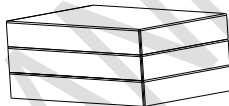

3 Box
内箱中共3盒产品



+

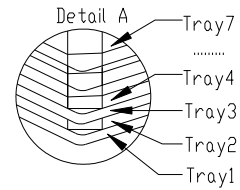
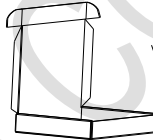
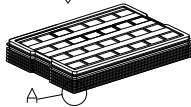

Rotate tray 180 degrees and place on top
of stack. Check the tray using Fig.A.
吸塑盘需旋转180°堆叠，顶部放置空吸塑盘，堆
叠后效果需和图A一致

The tape to seal
carton
attach label
使用胶带密封纸箱
贴附标签

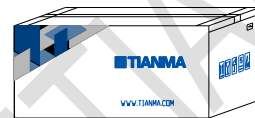

Put into carton
打包完成后装入纸箱

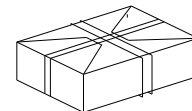
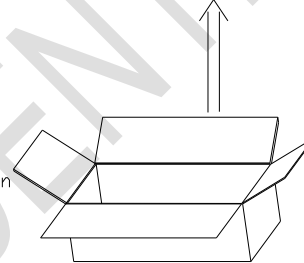

将多余的防尘袋空间折叠至正面
利用胶带固定

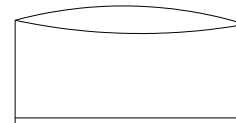

dust-proof bag
将3个装有产品的纸盒放入防尘袋中

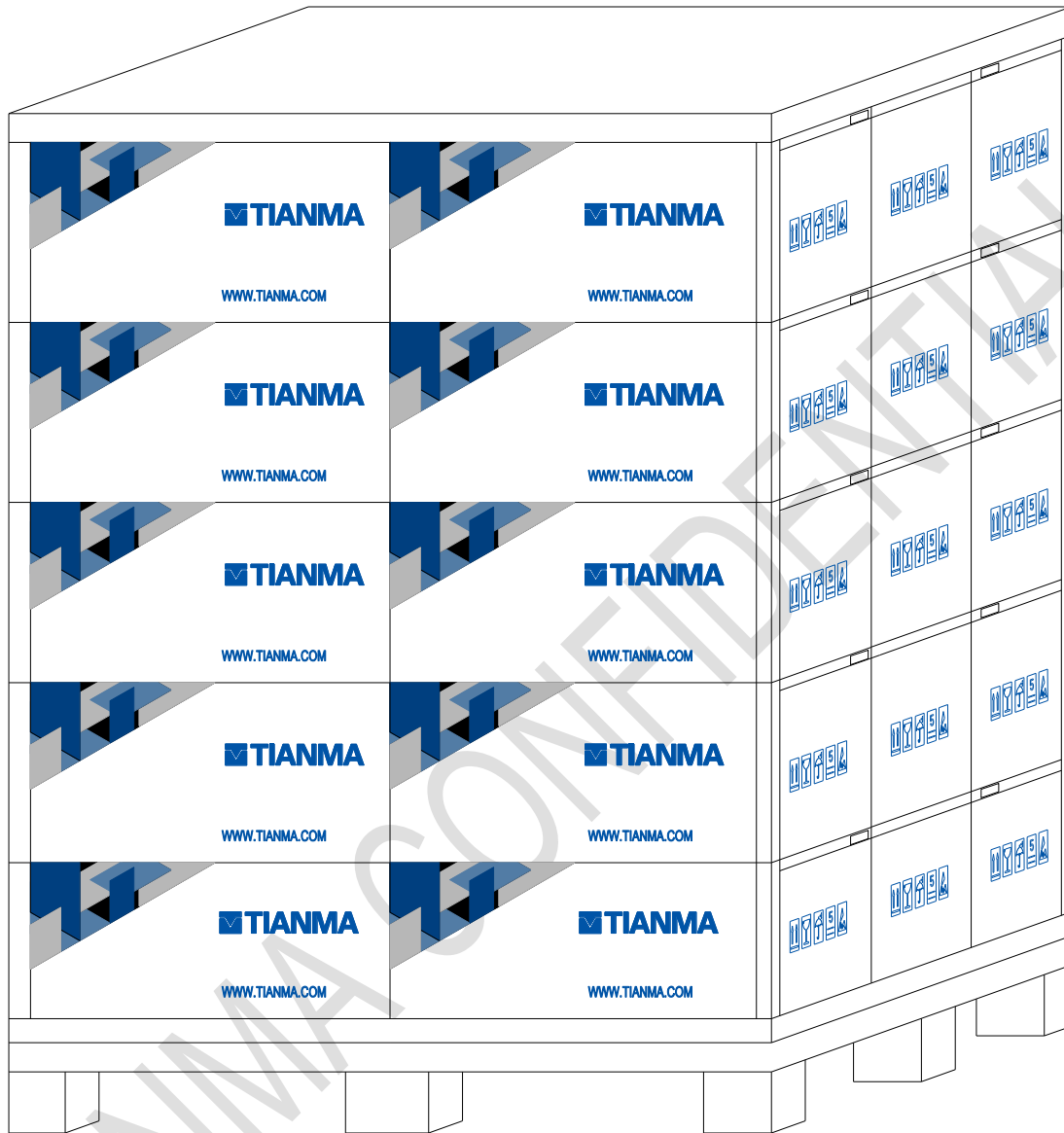

10 Precautions for Use of LCD Modules

10.1 Handling Precautions

10.1.1 The display panel is made of glass. Do not subject it to a mechanical shock by dropping it from a high place, etc.

10.1.2 If the display panel is damaged and the liquid crystal substance inside it leaks out, be sure not to get any in your mouth, if the substance comes into contact with your skin or clothes, promptly wash it off using soap and water.

10.1.3 Do not apply excessive force to the display surface or the adjoining areas since this may cause the color tone to vary.

10.1.4 The polarizer covering the display surface of the LCD module is soft and easily scratched. Handle this polarizer carefully.

10.1.5 If the display surface is contaminated, breathe on the surface and gently wipe it with a soft dry cloth. If still not completely clear, moisten cloth with one of the following solvents:

- Isopropyl alcohol
- Ethyl alcohol

Solvents other than those mentioned above may damage the polarizer. Especially, do not use the following:

- Water
- Ketone
- Aromatic solvents

10.1.6 Do not attempt to disassemble the LCD Module.

10.1.7 If the logic circuit power is off, do not apply the input signals.

10.1.8 To prevent destruction of the elements by static electricity, be careful to maintain an optimum work environment.

10.1.8.1 Be sure to ground the body when handling the LCD Modules.

10.1.8.2 Tools required for assembly, such as soldering irons, must be properly ground.

10.1.8.3 To reduce the amount of static electricity generated, do not conduct assembly and other work under dry conditions.

10.1.8.4 The LCD Module is coated with a film to protect the display surface. Be care when peeling off this protective film since static electricity may be generated.

10.2 Storage precautions

10.2.1 When storing the LCD modules, avoid exposure to direct sunlight or to the light of fluorescent lamps.

10.2.2 The LCD modules should be stored under the storage temperature range. If the LCD modules will be stored for a long time, the recommend condition is:

Temperature : 0°C ~ 40°C Relatively humidity: ≤80%

10.2.3 The LCD modules should be stored in the room without acid, alkali and harmful gas.

10.3 Transportation Precautions

10.3.1 The LCD modules should be no falling and violent shocking during transportation, and also should avoid excessive press, water, damp and sunshine.