

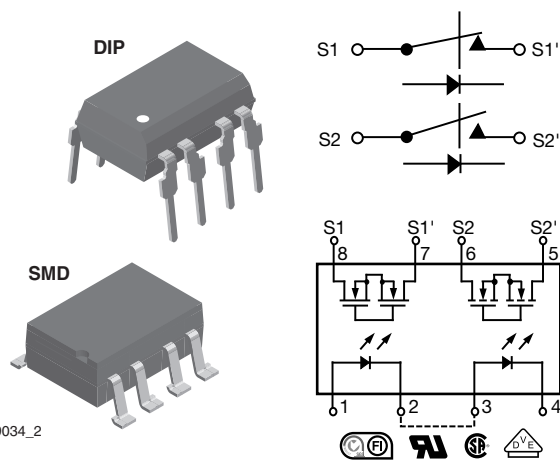

## Dual 1 Form A/B, C Solid State Relay



i179034\_2

### DESCRIPTION

The LH1512 relays contain normally open and normally closed switches that can be used independently as a 1 form A and 1 form B relay, or when used together, as a 1 form C relay. The relays are constructed as a mult.-chip hybrid device. Actuation control is via an infrared LED. The output switch is a combination of a photodiode array with MOSFET switches and control circuitry.

### FEATURES

- Current limit protection
- Isolation test voltage 3750 V<sub>RMS</sub>
- Typical R<sub>ON</sub> 10 Ω
- Load voltage 200 V
- Load current 200 mA
- High surge capability
- Clean bounce free switching
- Low power consumption
- SMD lead available on tape and reel
- Compliant to RoHS Directive 2002/95/EC and in accordance to WEEE 2002/96/EC



RoHS COMPLIANT

### APPLICATIONS

- General telecom switching
  - On/off hook control
  - Ring delay
  - Dial pulse
  - Ground start
  - Ground fault protection
- Instrumentation
- Industrial controls

### AGENCY APPROVALS

UL1577: file no. E52744 system code H, double protection  
 CSA: certification no. 093751  
 DIN EN: 60747-5-2 (VDE 0884)/60747-5-5 (pending), available with option 1  
 FIMKO: 25419

ORDERING INFORMATION	
<div style="display: flex; justify-content: space-around; align-items: center;"> <div style="border: 1px solid black; padding: 2px; margin: 2px;">L</div> <div style="border: 1px solid black; padding: 2px; margin: 2px;">H</div> <div style="border: 1px solid black; padding: 2px; margin: 2px;">1</div> <div style="border: 1px solid black; padding: 2px; margin: 2px;">5</div> <div style="border: 1px solid black; padding: 2px; margin: 2px;">1</div> <div style="border: 1px solid black; padding: 2px; margin: 2px;">2</div> <div style="border: 1px solid black; padding: 2px; margin: 2px;">B</div> <div style="border: 1px solid black; padding: 2px; margin: 2px;">#</div> <div style="border: 1px solid black; padding: 2px; margin: 2px;">#</div> <div style="border: 1px solid black; padding: 2px; margin: 2px;">T</div> <div style="border: 1px solid black; padding: 2px; margin: 2px;">R</div> </div> <p style="text-align: center;"> <span style="margin-right: 100px;">PART NUMBER</span> <span style="margin-right: 100px;">ELECTR. VARIATION</span> <span style="margin-right: 100px;">PACKAGE CONFIG.</span> <span style="margin-right: 100px;">TAPE AND REEL</span> </p>	
<b>PACKAGE</b>	<b>UL, CSA, FIMKO</b>
SMD-8, tubes	LH1512BAC
SMD-8, tape and reel	LH1512BACTR
DIP-8, tubes	LH1512BB



ABSOLUTE MAXIMUM RATINGS ( $T_{amb} = 25\text{ }^{\circ}\text{C}$ , unless otherwise specified)				
PARAMETER	TEST CONDITION	SYMBOL	VALUE	UNIT
<b>INPUT</b>				
LED continuous forward current		$I_F$	50	mA
LED reverse voltage	$I_R \leq 10\text{ }\mu\text{A}$	$V_R$	5	V
<b>OUTPUT</b>				
DC or peak AC load voltage	$I_L \leq 50\text{ }\mu\text{A}$	$V_L$	200	V
Continuous DC load current (form C operation)		$I_L$	200	mA
Peak load current, form A	$t = 100\text{ ms}$	$I_P$	(2)	
Peak load current (single shot), form B		$I_P$	400	mA
<b>SSR</b>				
Ambient operating temperature range		$T_{amb}$	- 40 to + 85	$^{\circ}\text{C}$
Storage temperature range		$T_{stg}$	- 40 to + 125	$^{\circ}\text{C}$
Pin soldering temperature (3)	$t = 10\text{ s max.}$	$T_{sld}$	260	$^{\circ}\text{C}$
Input to output isolation test voltage	$t = 1\text{ s, } I_{ISO} = 10\text{ }\mu\text{A max.}$	$V_{ISO}$	3750	$V_{RMS}$
Pole-to-pole isolation voltage (S1 to S2) (1) (dry air, dust free, at sea level)			1600	V
Output power dissipation (continuous)		$P_{diss}$	600	mW

**Notes**

- Stresses in excess of the absolute maximum ratings can cause permanent damage to the device. Functional operation of the device is not implied at these or any other conditions in excess of those given in the operational sections of this document. Exposure to absolute maximum ratings for extended periods of the time can adversely affect reliability.
- Breakdown occurs between the output pins external to the package.
- Refer to current limit performance application note for a discussion on relay operation during transient currents.
- Refer to reflow profile for soldering conditions for surface mounted devices (SMD). Refer to wave profile for soldering conditions for through hole devices (DIP).

ELECTRICAL CHARACTERISTICS ( $T_{amb} = 25\text{ }^{\circ}\text{C}$ , unless otherwise specified)						
PARAMETER	TEST CONDITION	SYMBOL	MIN.	TYP.	MAX.	UNIT
<b>INPUT</b>						
LED forward current switch turn-on (NO)	$I_L = 100\text{ mA, } t = 10\text{ ms}$	$I_{Fon}$		0.6	2	mA
LED forward current switch turn-off (NO)	$V_L = \pm 150\text{ V}$	$I_{Foff}$	0.2	0.5		mA
LED forward current switch turn-on (NC)	$I_L = 100\text{ mA, } t = 10\text{ ms}$	$I_{Fon}$	0.2	0.9		mA
LED forward current switch turn-off (NC)	$V_L = \pm 150\text{ V}$	$I_{Foff}$		1	2	mA
LED forward voltage	$I_F = 10\text{ mA}$	$V_F$	1.15	1.26	1.45	V
<b>OUTPUT</b>						
On-resistance: (NO, NC)	$I_F = 5\text{ mA (NO), } I_F = 0\text{ (NC), } I_L = 50\text{ mA (NC)}$	$R_{ON}$		10	15	$\Omega$
Off-resistance: (NO)	$I_F = 0\text{ mA, } V_L = \pm 100\text{ V}$	$R_{OFF}$	0.35	5000		$G\Omega$
Off-resistance: (NC)	$I_F = 5\text{ mA, } V_L = \pm 100\text{ V}$	$R_{OFF}$	0.1	1.4		$G\Omega$
Current limit: (NO)	$I_F = 5\text{ mA, } t = 5\text{ ms, } V_L = \pm 5\text{ V}$	$I_{LMT}$	270	360	460	mA
Off-state leakage current: (NO)	$I_F = 0\text{ mA, } V_L = \pm 100\text{ V}$	$I_O$		0.02	1000	nA
Off-state leakage current: (NC)	$I_F = 5\text{ mA, } V_L = \pm 100\text{ V}$	$I_O$		0.07	1	$\mu\text{A}$
Off-state leakage current: (NO, NC)	$I_F = 0\text{ mA (NO), } I_F = 5\text{ mA, } V_L = \pm 200\text{ V}$	$I_O$			1	$\mu\text{A}$
Output capacitance: (NO)	$I_F = 0\text{ mA, } V_L = 50\text{ V}$	$C_O$		60		pF
Output capacitance: (NC)	$I_F = 5\text{ mA, } V_L = 50\text{ V}$	$C_O$		60		pF
<b>TRANSFER</b>						
Capacitance (input to output)	$V_{ISO} = 1\text{ V}$	$C_{IO}$		3		pF

**Note**

- Minimum and maximum values are testing requirements. Typical values are characteristics of the device and are the result of engineering evaluations. Typical values are for information only and are not part of the testing requirements.

SWITCHING CHARACTERISTICS ( $T_{amb} = 25\text{ }^{\circ}\text{C}$ , unless otherwise specified)						
PARAMETER	TEST CONDITION	SYMBOL	MIN.	TYP.	MAX.	UNIT
Turn-on time (NO)	$I_F = 10\text{ mA, } I_L = 50\text{ mA}$	$t_{on}$		1.4	3	ms
Turn-on time (NC)	$I_F = 10\text{ mA, } I_L = 50\text{ mA}$	$t_{on}$		1.2	3	ms
Turn-off time (NO)	$I_F = 10\text{ mA, } I_L = 50\text{ mA}$	$t_{off}$		0.7	3	ms
Turn-off time (NC)	$I_F = 10\text{ mA, } I_L = 50\text{ mA}$	$t_{off}$		2	3	ms



## TYPICAL CHARACTERISTICS (T<sub>amb</sub> = 25 °C, unless otherwise specified)

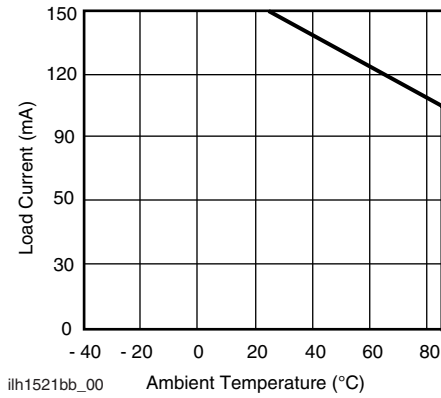

ilh1512bb\_00

Fig. 1 - Recommended Operating Conditions

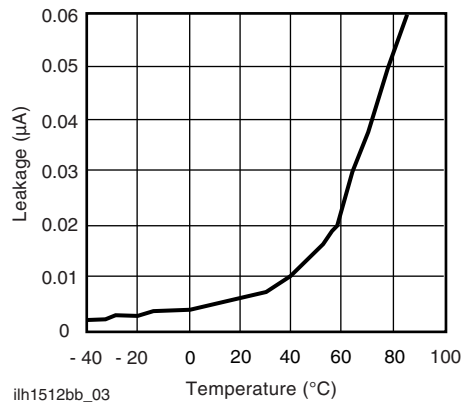

ilh1512bb\_03

Fig. 4 - Typical Leakage vs. Temperature (Measured across Pin 5 and 6 or 7 and 8)

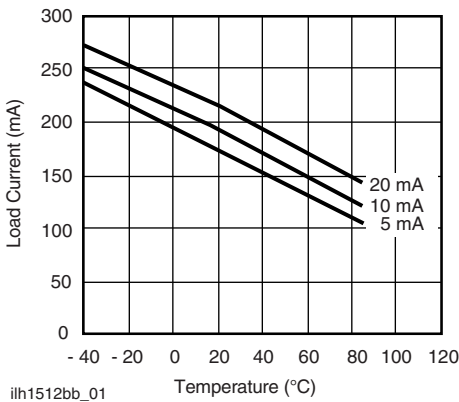

ilh1512bb\_01

Fig. 2 - Form A Typical Load Current vs. Temperature

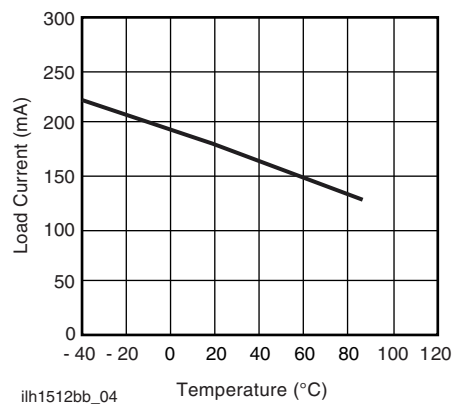

ilh1512bb\_04

Fig. 5 - Form B Typical Load Current vs. Temperature

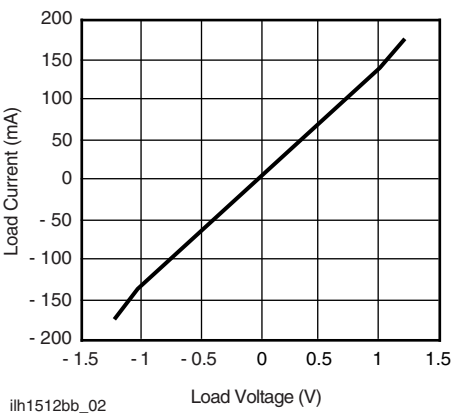

ilh1512bb\_02

Fig. 3 - Form A Typical Load Current vs. Load Voltage

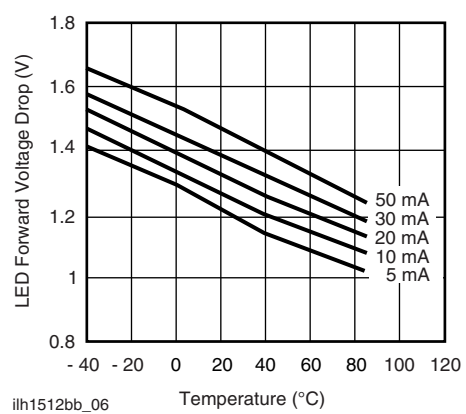

ilh1512bb\_06

Fig. 6 - Typical LED Forward Voltage Drop vs. Temperature

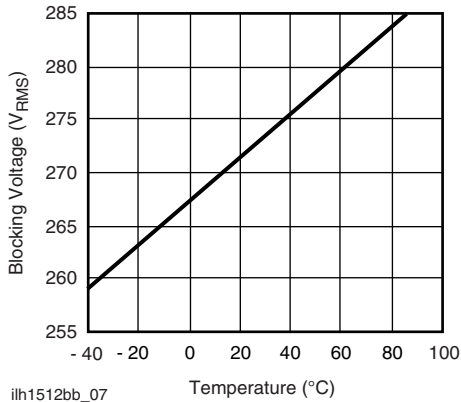

Fig. 7 - Form A Typical Blocking Voltage vs. Temperature

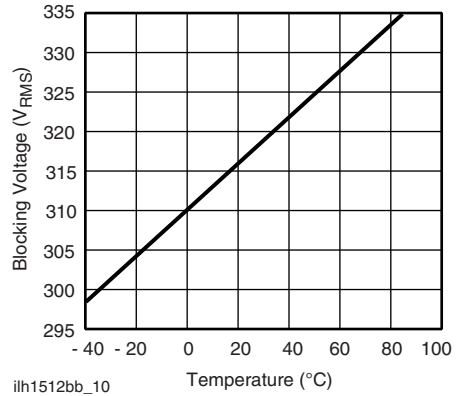

Fig. 10 - Form B Typical Blocking Voltage vs. Temperature

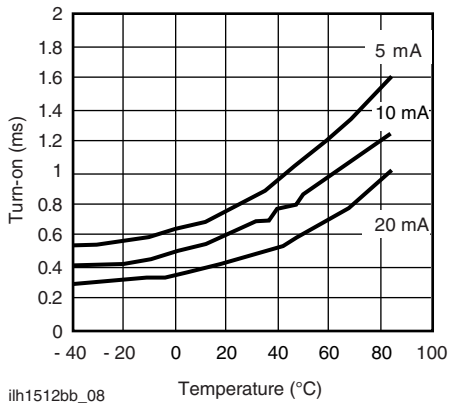

Fig. 8 - Form A Typical Turn-On vs. Temperature

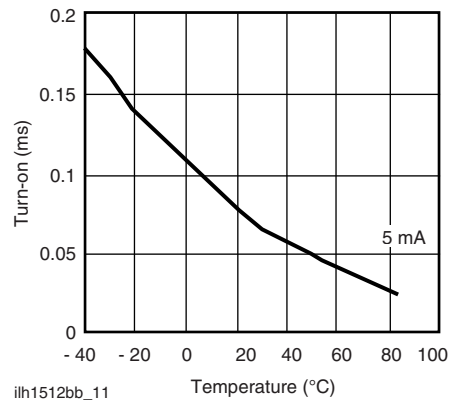

Fig. 11 - Form B Typical Turn-On vs. Temperature

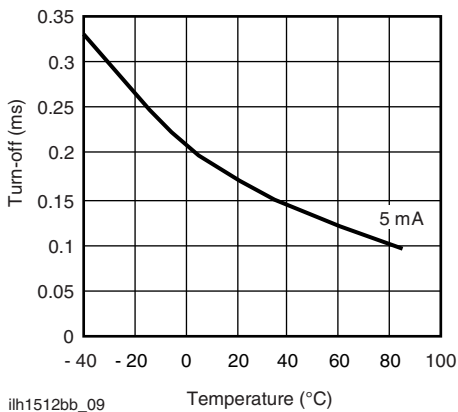

Fig. 9 - Form A Typical Turn-Off vs. Temperature

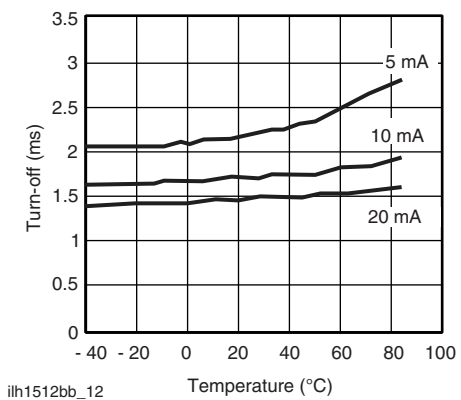
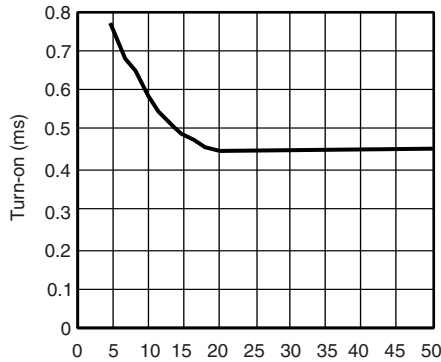
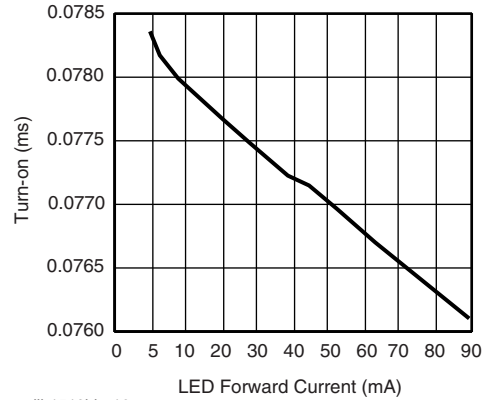

Fig. 12 - Form B Typical Turn-Off vs. Temperature



ilh1512bb\_13 LED Forward Current (mA)

Fig. 13 - Form A Typical Turn-On vs. LED Forward Current



ilh1512bb\_16

Fig. 16 - Form B Typical Turn-On vs. LED Forward Current

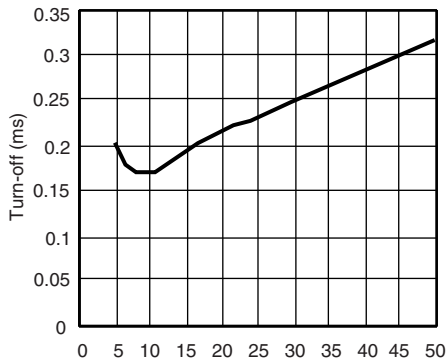

ilh1512bb\_14 LED Forward Current (mA)

Fig. 14 - Form A Typical Turn-Off vs. LED Forward Current

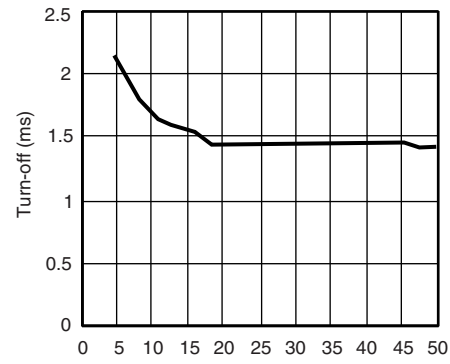

ilh1512bb\_17

Fig. 17 - Form B Typical Turn-Off vs. LED Forward Current

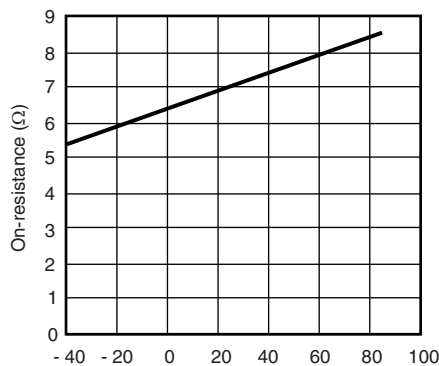

ilh1512bb\_15 Temperature (°C)

Fig. 15 - Form A Typical On-Resistance vs. Temperature

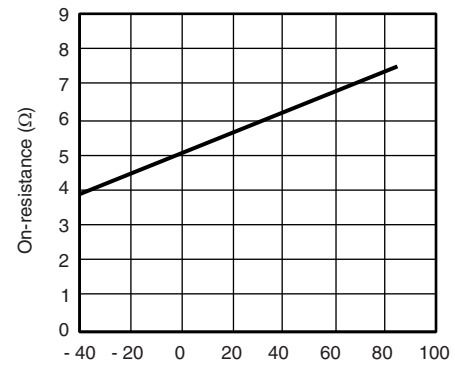

ilh1512bb\_18 Temperature (°C)

Fig. 18 - Form B Typical On-Resistance vs. Temperature

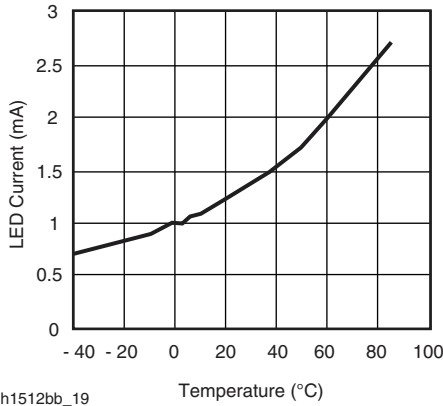

ih1512bb\_19

Fig. 19 - Form A Typical  $I_F$  for Switch Operation vs. Temperature

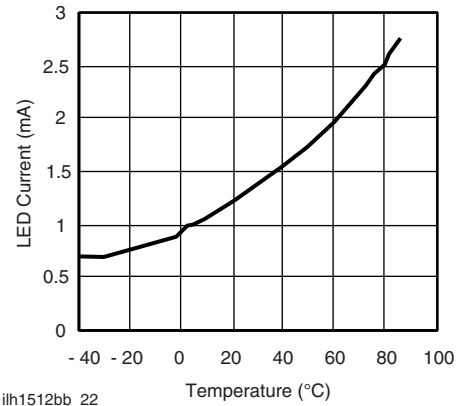

ih1512bb\_22

Fig. 22 - Form B Typical  $I_F$  for Switch Dropout vs. Temperature

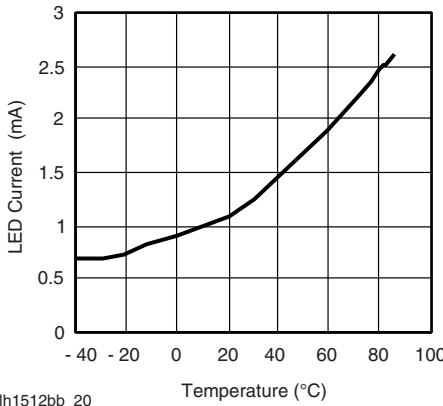

ih1512bb\_20

Fig. 20 - Form A Typical  $I_F$  for Switch Dropout vs. Temperature

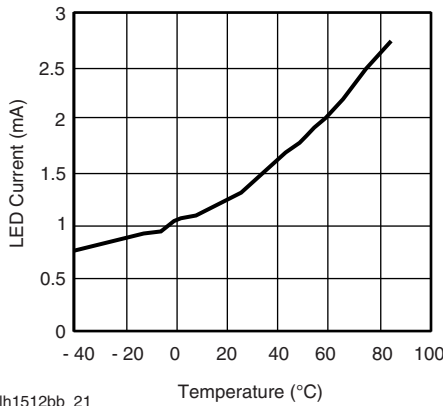

ih1512bb\_21

Fig. 21 - Form B Typical  $I_F$  for Switch Operation vs. Temperature



## PACKAGE DIMENSIONS in millimeters

### DIP

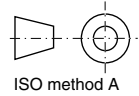
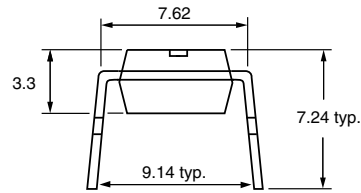
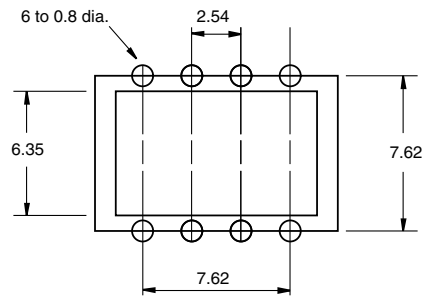
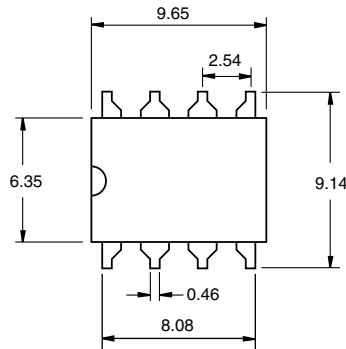

i178017

### SMD

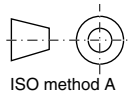
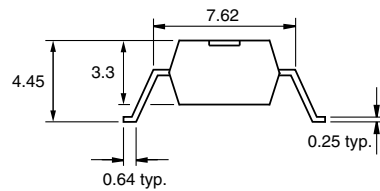
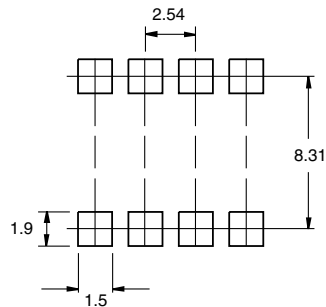
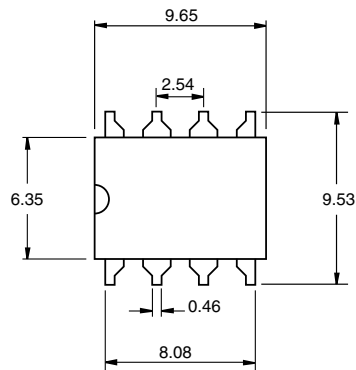

i178018

## PACKAGE MARKING (example)

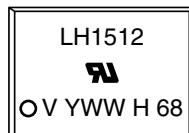

### Note

- Tape and reel suffix (TR) is not part of the package marking.



## Footprint and Schematic Information for LH1512BAC, LH1512BACTR, LH1512BB

The footprint and schematic symbols for the following parts can be accessed using the associated links. They are available in Eagle, Altium, KiCad, OrCAD / Allegro, Pulsonix, and PADS.

Note that the 3D models for these parts can be found on the Vishay product page.

PART NUMBER	FOOTPRINT / SCHEMATIC
LH1512BAC	<a href="http://www.snapeda.com/parts/LH1512BAC/Vishay/view-part">www.snapeda.com/parts/LH1512BAC/Vishay/view-part</a>
LH1512BACTR	<a href="http://www.snapeda.com/parts/LH1512BACTR/Vishay/view-part">www.snapeda.com/parts/LH1512BACTR/Vishay/view-part</a>
LH1512BB	<a href="http://www.snapeda.com/parts/LH1512BB/Vishay/view-part">www.snapeda.com/parts/LH1512BB/Vishay/view-part</a>

For technical issues and product support, please contact [optocoupleranswers@vishay.com](mailto:optocoupleranswers@vishay.com).

DIP

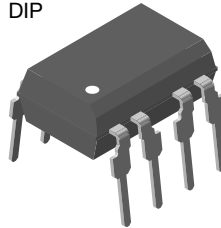

SMD

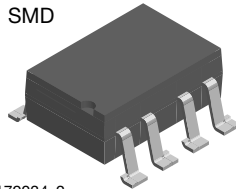

i179034\_2





## **Disclaimer**

ALL PRODUCT, PRODUCT SPECIFICATIONS AND DATA ARE SUBJECT TO CHANGE WITHOUT NOTICE TO IMPROVE RELIABILITY, FUNCTION OR DESIGN OR OTHERWISE.

Vishay Intertechnology, Inc., its affiliates, agents, and employees, and all persons acting on its or their behalf (collectively, "Vishay"), disclaim any and all liability for any errors, inaccuracies or incompleteness contained in any datasheet or in any other disclosure relating to any product.

Vishay makes no warranty, representation or guarantee regarding the suitability of the products for any particular purpose or the continuing production of any product. To the maximum extent permitted by applicable law, Vishay disclaims (i) any and all liability arising out of the application or use of any product, (ii) any and all liability, including without limitation special, consequential or incidental damages, and (iii) any and all implied warranties, including warranties of fitness for particular purpose, non-infringement and merchantability.

Statements regarding the suitability of products for certain types of applications are based on Vishay's knowledge of typical requirements that are often placed on Vishay products in generic applications. Such statements are not binding statements about the suitability of products for a particular application. It is the customer's responsibility to validate that a particular product with the properties described in the product specification is suitable for use in a particular application. Parameters provided in datasheets and / or specifications may vary in different applications and performance may vary over time. All operating parameters, including typical parameters, must be validated for each customer application by the customer's technical experts. Product specifications do not expand or otherwise modify Vishay's terms and conditions of purchase, including but not limited to the warranty expressed therein.

Except as expressly indicated in writing, Vishay products are not designed for use in medical, life-saving, or life-sustaining applications or for any other application in which the failure of the Vishay product could result in personal injury or death. Customers using or selling Vishay products not expressly indicated for use in such applications do so at their own risk. Please contact authorized Vishay personnel to obtain written terms and conditions regarding products designed for such applications.

No license, express or implied, by estoppel or otherwise, to any intellectual property rights is granted by this document or by any conduct of Vishay. Product names and markings noted herein may be trademarks of their respective owners.