

# EMC5050 9V SQUARE



## DATASHEET

The latest EMC5050 LED series combines high efficiency performance with long lifespan. It has excellent temperature resistance and anti-corrosion performance, further enhancing high reliability and suitability for outdoor professional lighting. It is available in all ANSI CCT and provides the efficacy and reliability required by the high power outdoor lighting markets.



---

### ■Feature

- ◆ Low Thermal Resistance
- ◆ Super Energy Efficiency
- ◆ Half Angle ( $2\Theta_{1/2}$ ):120°
- ◆ RoHS Compliant

---

### ■Applications

- ◆ Decoration lighting
- ◆ Advertisement
- ◆ Street Lamps
- ◆ Other Lighting



# Table of Contents

<b>Introduction</b> .....	<b>1</b>
Features.....	1
Applications.....	1
<b>Product Code Information</b> .....	<b>2</b>
Part Number Nomenclature.....	2
Product Selection Guide.....	3
Absolute Maximum Rating.....	4
<b>Chromaticity Region &amp; Coordinates</b> .....	<b>5</b>
Chromaticity Region & Coordinates.....	5
Mac Adam Ellipse.....	6
<b>Typical Characteristics Graphs</b> .....	<b>7</b>
Spectrum Power Distribution Characteristics.....	7
Characteristic Curves.....	8.9
Optical Curves.....	9
<b>Mechanical Dimensions</b> .....	<b>10</b>
<b>Solder Pad Design</b> .....	<b>10</b>
<b>Reflow Soldering Guidelines</b> .....	<b>11</b>
<b>Reliability</b> .....	<b>12</b>
Test Items and Results.....	12
Failure Criteria.....	12
<b>Tape &amp; Reel</b> .....	<b>13</b>
Taping Dimension.....	13
Reel Dimension.....	13
<b>Label Structure</b> .....	<b>14</b>
Label Structure.....	14
Label Explanation.....	14
<b>Packing Structure</b> .....	<b>15</b>
Packing Process.....	15
Aluminum Vinyl Packing Bag.....	16
Silica Gel & Humidity Indicator Card inside Aluminum Vinyl Bag.....	16
<b>Precautions in Handling &amp; Use</b> .....	<b>17</b>

## 1. Product Code Information

### a) Part Number Nomenclature

X	E	X	X	0	X	0	X	W	H	X	X	B	-	22	-	70	-	FS
C	D	E	F	G	H	I	J	K	L	M	N	O		P		Q	If coded	R

Digit	PKG Information	Code	Specification
C	Color	C	Cold White
		W	White
		N	Nature White
		I	Warm White
DEF	Package Model and size	E20	5.0*5.0*0.7mm Square LES Type
GHIJ	Series & Parallel	0304	DC 9V
KL	Product category	WH	General Lighting
MN	Internal Code	31	/
		36	/
O	Brightness level	B	Normal
		H	High
P	CCT	22	2200K
		27	2700K
		30	3000K
		35	3500K
		40	4000K
		50	5000K
		57	5700K
		65	6500K
Q	CRI (Ra)	70	CRI (Ra) Min 70
		80	CRI (Ra) Min 80
		90	CRI (Ra) Min 90
R	Process Type	FS	Anti-sulfurization Layer Coated

## b) Product Selection Guide

Available CCT (K)	CRI/Ra Min	Lumen Flux (Lm)	Forward Current (IF)	Forward Voltage (VF)	Product Code
2200K	70	710-760	500	8.5-8.8-9.1	IE200304WH36B-22-70
2700K	70	730-780	500	8.5-8.8-9.1	IE200304WH36B-27-70
3000K	70	750-800	500	8.5-8.8-9.1	IE200304WH36B-30-70
3500K	70	780-830	500	8.5-8.8-9.1	IE200304WH36B-35-70
4000K	70	810-860	500	8.5-8.8-9.1	NE200304WH36B-40-70
5000K	70	810-860	500	8.5-8.8-9.1	WE200304WH36B-50-70
5700K	70	800-850	500	8.5-8.8-9.1	WE200304WH36B-57-70
6500K	70	800-850	500	8.5-8.8-9.1	WE200304WH36B-65-70
2200K	80	660-710	500	8.5-8.8-9.1	IE200304WH36B-22-80
2700K	80	680-730	500	8.5-8.8-9.1	IE200304WH36B-27-80
3000K	80	700-750	500	8.5-8.8-9.1	IE200304WH36B-30-80
3500K	80	730-780	500	8.5-8.8-9.1	IE200304WH36B-35-80
4000K	80	760-810	500	8.5-8.8-9.1	NE200304WH36B-40-80
5000K	80	760-810	500	8.5-8.8-9.1	WE200304WH36B-50-80
5700K	80	750-800	500	8.5-8.8-9.1	WE200304WH36B-57-80
6500K	80	750-800	500	8.5-8.8-9.1	WE200304WH36B-65-80

c) Absolute Maximum Rating(At TA =25°C)

Parameter	Symbol	Value	Units
Power Dissipation	PI	5	W
Operating current range	IF	550	mA
Junction Temperature	TJ	120	°C
ESD(HBM)	-	2	KV
Operating Temperature Range	TOPR	-20°C To +105°C	
Storage Temperature Range	Tstg	-40°C To +100°C	
Manual Soldering Temperature	TSOL	350°C± 20°C For 3~5 Seconds	

**Equivalent circuit diagram**

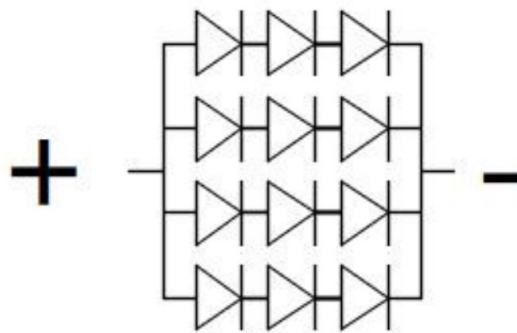

## 2. Chromaticity Region & Coordinates (IF= 500mA, Ts= 25°C)

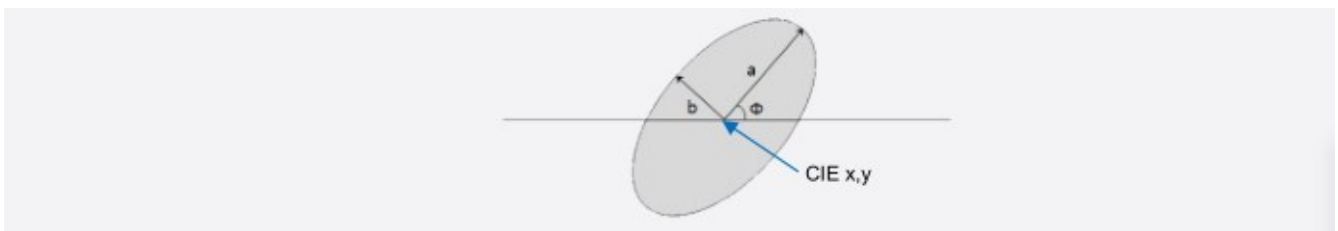
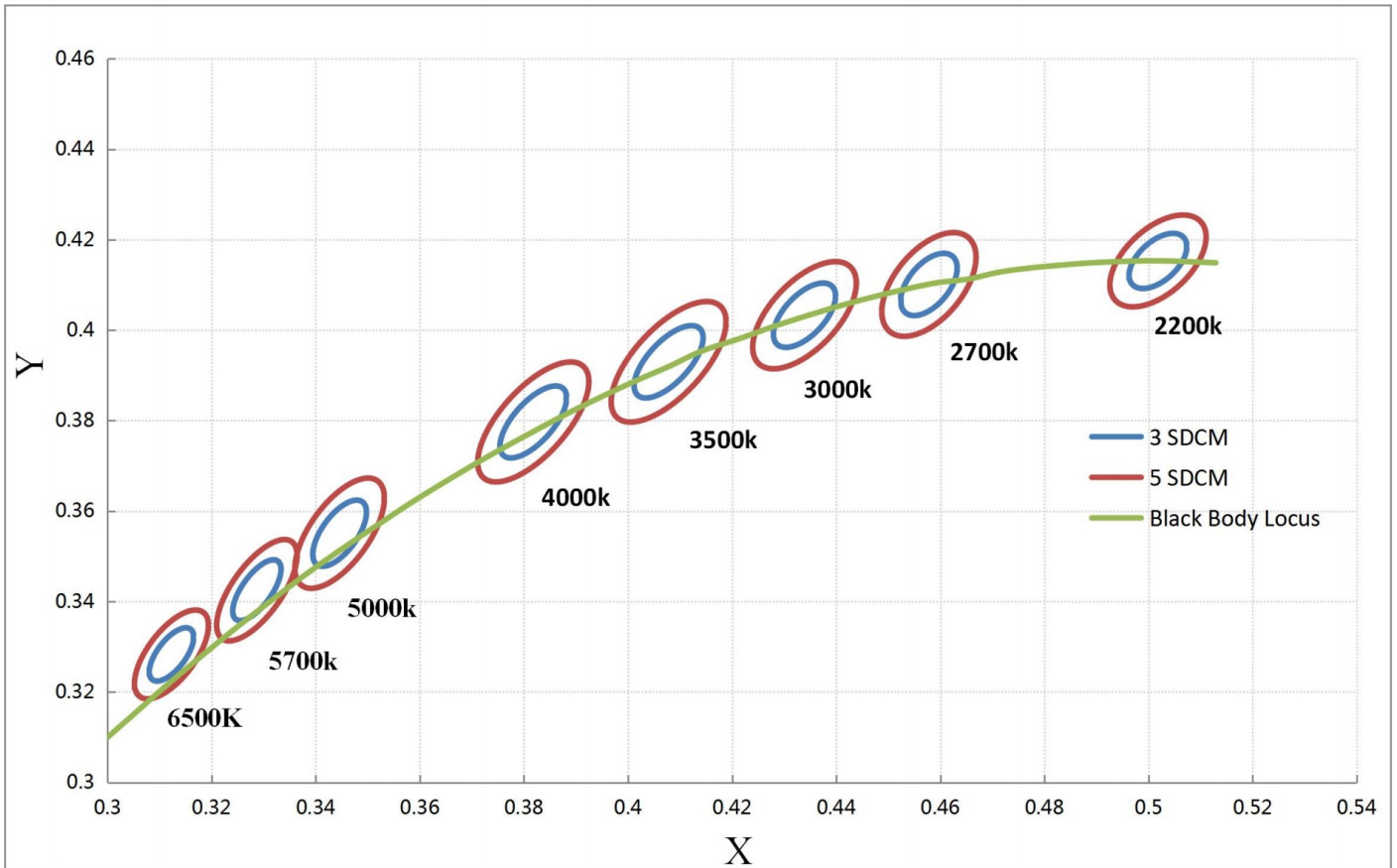

### Mac Adam Ellipse

Mac Adam Ellipse ( 2200K )						Mac Adam Ellipse ( 2700K )					
Step	CIE X	CIE Y	$\theta$	a	b	Step	CIE X	CIE Y	$\theta$	a	b
3-step	0.5018	0.4153	-39.89	0.004	0.0072	3-step	0.4578	0.4101	53.7	0.0081	0.0042
5-step	0.5018	0.4153	-39.89	0.0067	0.01201	5-step	0.4578	0.4101	53.7	0.0135	0.007

Mac Adam Ellipse ( 3000K )						Mac Adam Ellipse ( 3500K )					
Step	CIE X	CIE Y	$\theta$	a	b	Step	CIE X	CIE Y	$\theta$	a	b
3-step	0.4338	0.403	53.22	0.0083	0.0041	3-step	0.4073	0.3917	54	0.00927	0.00414
5-step	0.4338	0.403	53.22	0.0139	0.0068	5-step	0.4073	0.3917	54	0.01545	0.0069

Mac Adam Ellipse ( 4000K )						Mac Adam Ellipse ( 5000K )					
Step	CIE X	CIE Y	$\theta$	a	b	Step	CIE X	CIE Y	$\theta$	a	b
3-step	0.3818	0.3797	53.72	0.00939	0.00402	3-step	0.3447	0.3553	59.62	0.0082	0.0035
5-step	0.3818	0.3797	53.72	0.01565	0.0067	5-step	0.3447	0.3553	59.62	0.0137	0.0059

Mac Adam Ellipse ( 5700K )						Mac Adam Ellipse ( 6500K )					
Step	CIE X	CIE Y	$\theta$	a	b	Step	CIE X	CIE Y	$\theta$	a	b
3-step	0.3287	0.3417	59.09	0.00746	0.0032	3-step	0.3123	0.3282	58.57	0.00669	0.00285
5-step	0.3287	0.3417	59.09	0.01243	0.00533	5-step	0.3123	0.3282	58.57	0.01115	0.00475

**Note:**

Maintains measurement tolerance of:  $C_x, C_y = \pm 0.005$ .

### 3. Typical Characteristics Graphs

a) Spectrum Power Distribution Characteristics (IF=500mA, Ts= 25°C)

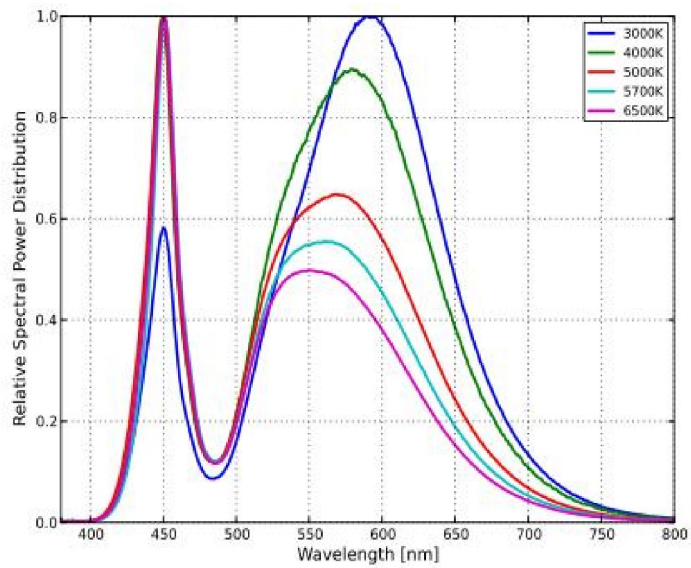

Figure1. Typical Color Spectrum for 70CRI

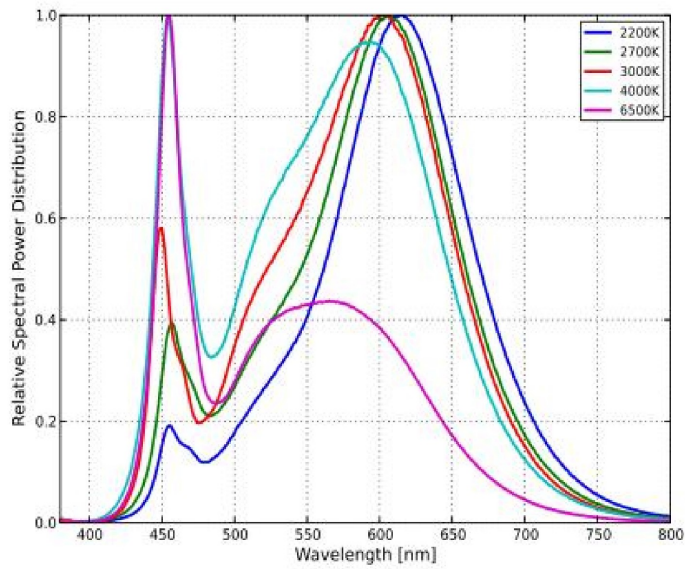

Figure2. Typical Color Spectrum for 80CRI

b) Characteristic Curves(IF=500mA, Ts= 25°C)

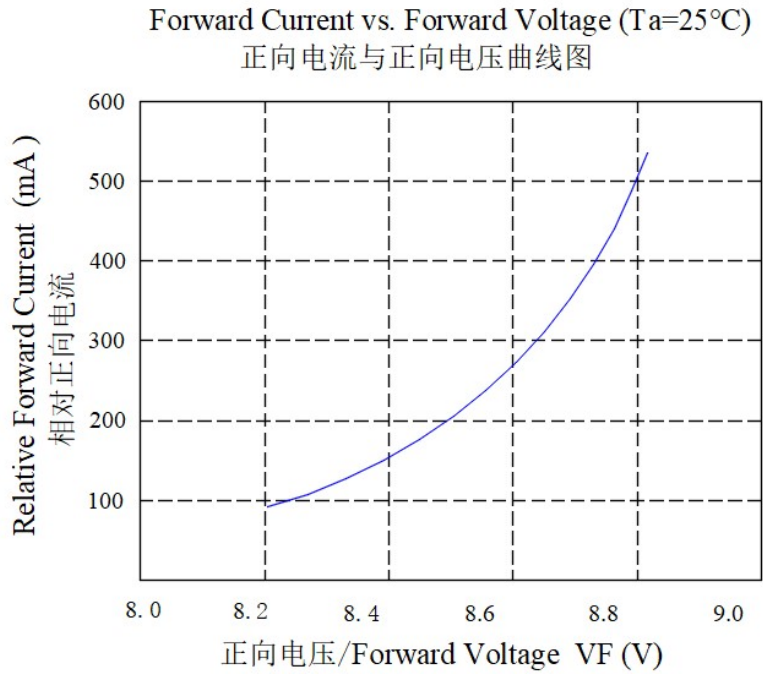

Figure3. Typical forward current VS forward voltage

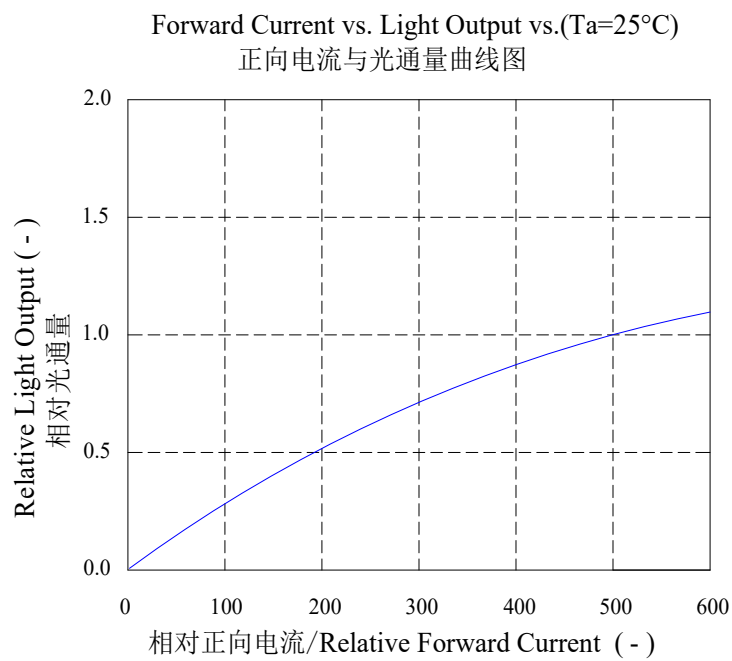

Figure4. Typical normalized light output vs. forward current

Light Output Vs. Junction Temperature  
 结点温度与光通量曲线图

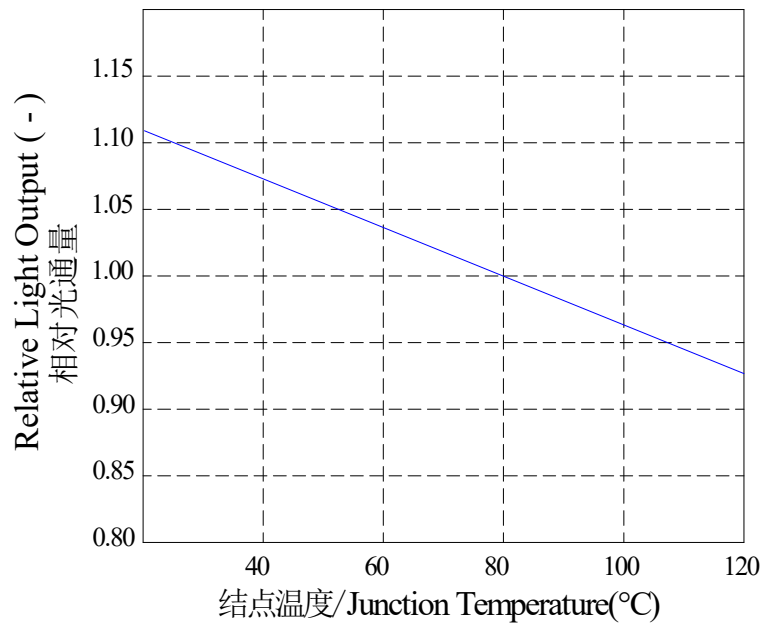

Figure5. Typical normalized light output vs Junction temperature

c) Optical Curves (IF=500mA, Ts= 25°C)

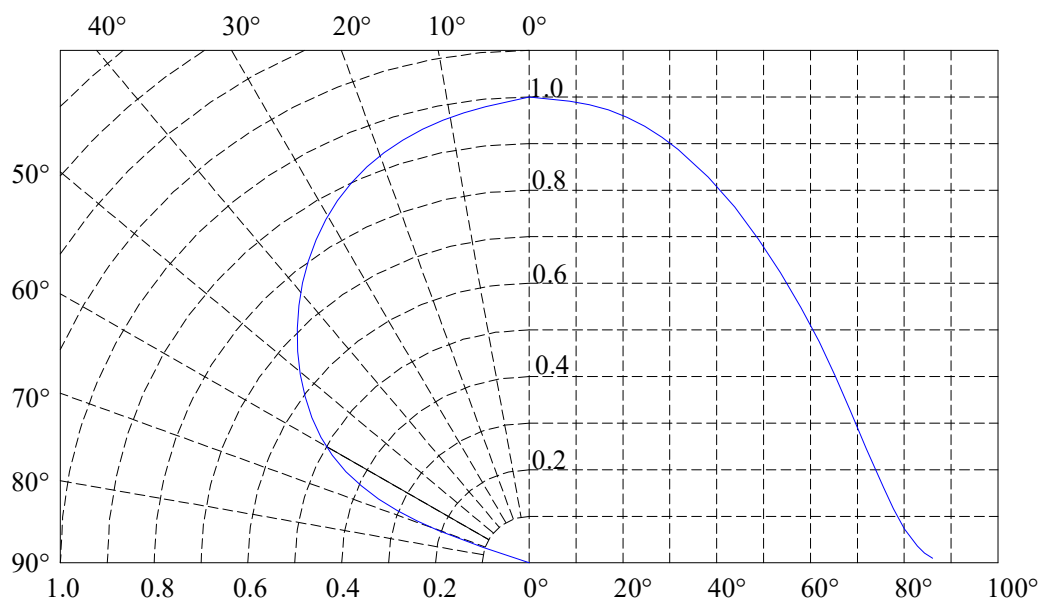
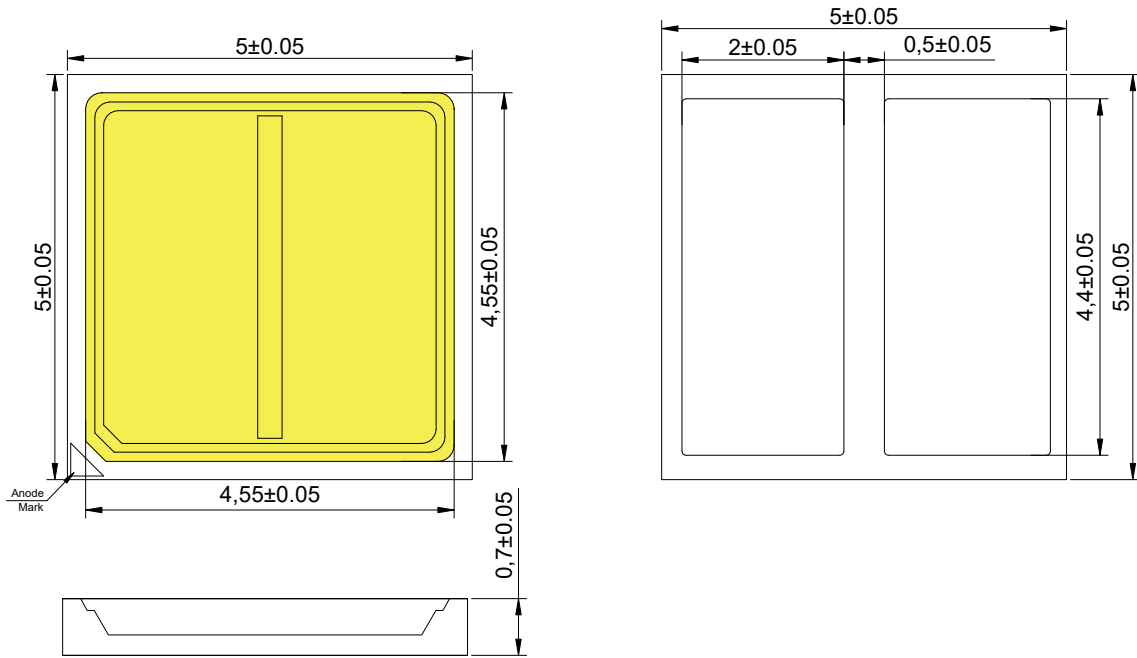
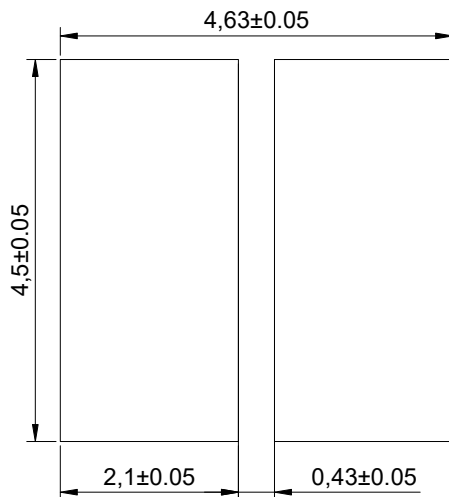

Figure6. Radiation Characteristics

### 4. Mechanical Dimensions



### Solder Pad Design



## 5. Reflow Soldering Guidelines

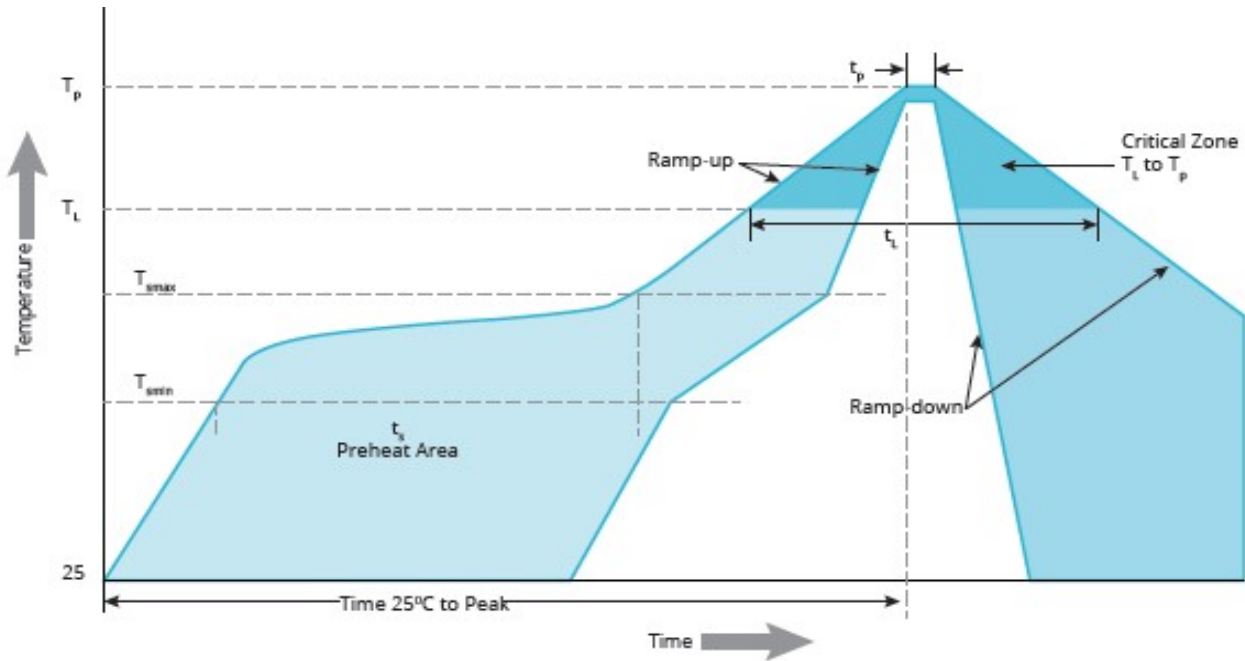

Feature	Lead-Free Medium Temperature Welding	Lead-free High Temperature Welding
Preheat: minimum temperature (Ts min)	120°C	150°C
Preheat: maximum temperature (Ts max)	160°C	200°C
Preheat: Time (ts min to ts max)	60 to 150 seconds	60 to 150 seconds
In the above temperature hold: temperature (TL)	180°C	217°C
In the above temperature hold: time (TL)	30 to 60 seconds	30 to 60 seconds
Peak temperature	210°C	260°C
The actual peak temperature is maintained within $\pm 5^\circ\text{C}$	20 to 30 seconds	5 to 10 seconds
Temperature drop slope	6°C/second(Max)	6°C/second(Max)
Conventional temperature 25 ° C to peak temperature	Within 6 minutes	Within 6 minutes

### Note:

1. Medium and high temperature lead-free reflow recommended temperature curve as shown above. It is forbidden that the maximum temperature over (high temperature: 260 ° C / 10S), (Medium Temperature: 210 ° C / 30S)
2. Adjust to the appropriate temperature, select the corresponding solder paste, make sure that you make a sample to check it first.
3. The above temperature is based on the actual furnace temperature.
4. Medium temperature solder paste is recommended.

## 6. Reliability

### 1 ) Test Items and Results

Test	Reference Standard	Test Condition	Test Duration	Failure Criteria	Units Failed/Tested
Temperature Cycle	JEITA ED-4701 100 105	-40°C(30min)~25°C(5min)~ 80°C(30min)~25°C(5min)	100cyces	#1	0/10
High Temperature Storage	JEITA ED-4701 200 201	T <sub>A</sub> =100°C	1000hours	#1	0/10
Temperature Humidity Storage	JEITA ED-4701 100 103	T <sub>A</sub> =85°C RH=85%	1000hours	#1	0/10
Low Temperature Storage	JEITA ED-4701 200 202	T <sub>A</sub> =-40°C	1000hours	#1	0/10
Room Temperature Operating Life		T <sub>A</sub> =25°C,IF=500mA	1000hours	#1	0/10
High Temperature Operating Life		T <sub>A</sub> =90°C,IF=500mA	1000hours	#1	0/10

### 2 ) Failure Criteria

Criteria#	Items	Conditions	Failure Criteria
#1	Forward Voltage(V <sub>F</sub> )	I <sub>F</sub> = 500mA	>Initial valuex1.2
	Luminous Flux(Φ <sub>v</sub> )	I <sub>F</sub> = 500mA	<Initial valuex0.7
U.S.L.:Upper Standard Level	L.S.L.:Lower Standard Level		

## 7. Tape & Reel

### a) Taping Dimension

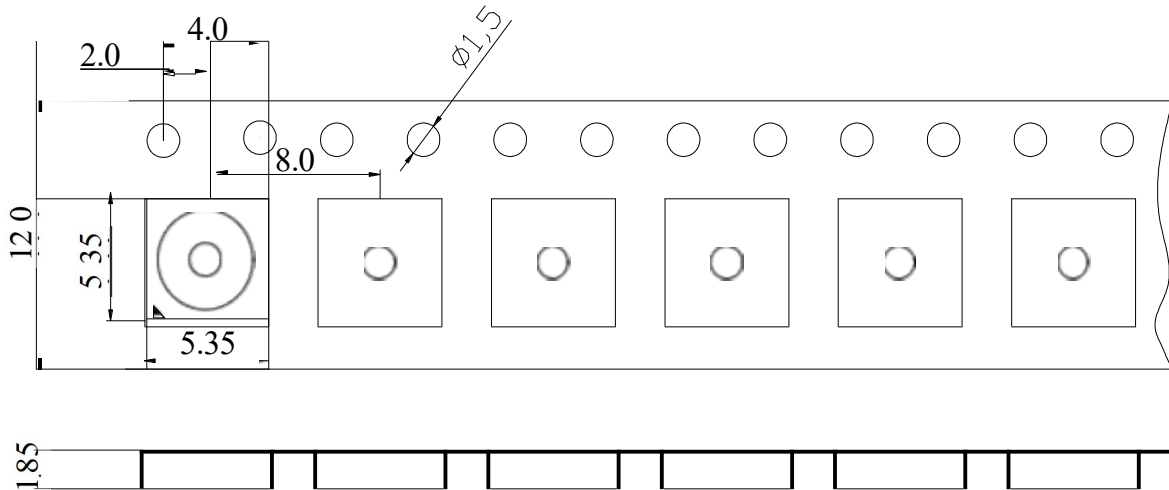

### b) Reel Dimension

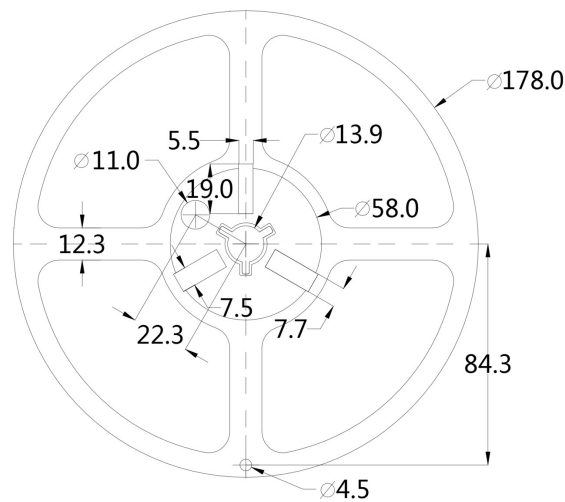

Notes:

- 1) Quantity: The quantity/reel is 2,000 pcs.
- 2) Cumulative Tolerance: Cumulative tolerance / 10 pitches is  $\pm 0.5$  mm.
- 3) Adhesion Strength of Cover Tape: Adhesion strength is 0.1-0.7 N when the cover tape is turned off from the carrier tape at 10° angle to the carrier tape.
- 4) Packaging: P/N, Manufacturing data code no. and quantity are indicated on the aluminum packing bag.

### 8. Label Structure

#### a) Label Structure



#### b) Label Explanation

Part No. : Product Code

VF: Forward Voltage Range

IF: Testing Current

CCT:

QTY: Quantity

Lot No.: Production batch Number

### 9. Packing Structure

a) Packing Process (The quantity of PKG on the Reel to be Max 2,000pcs)

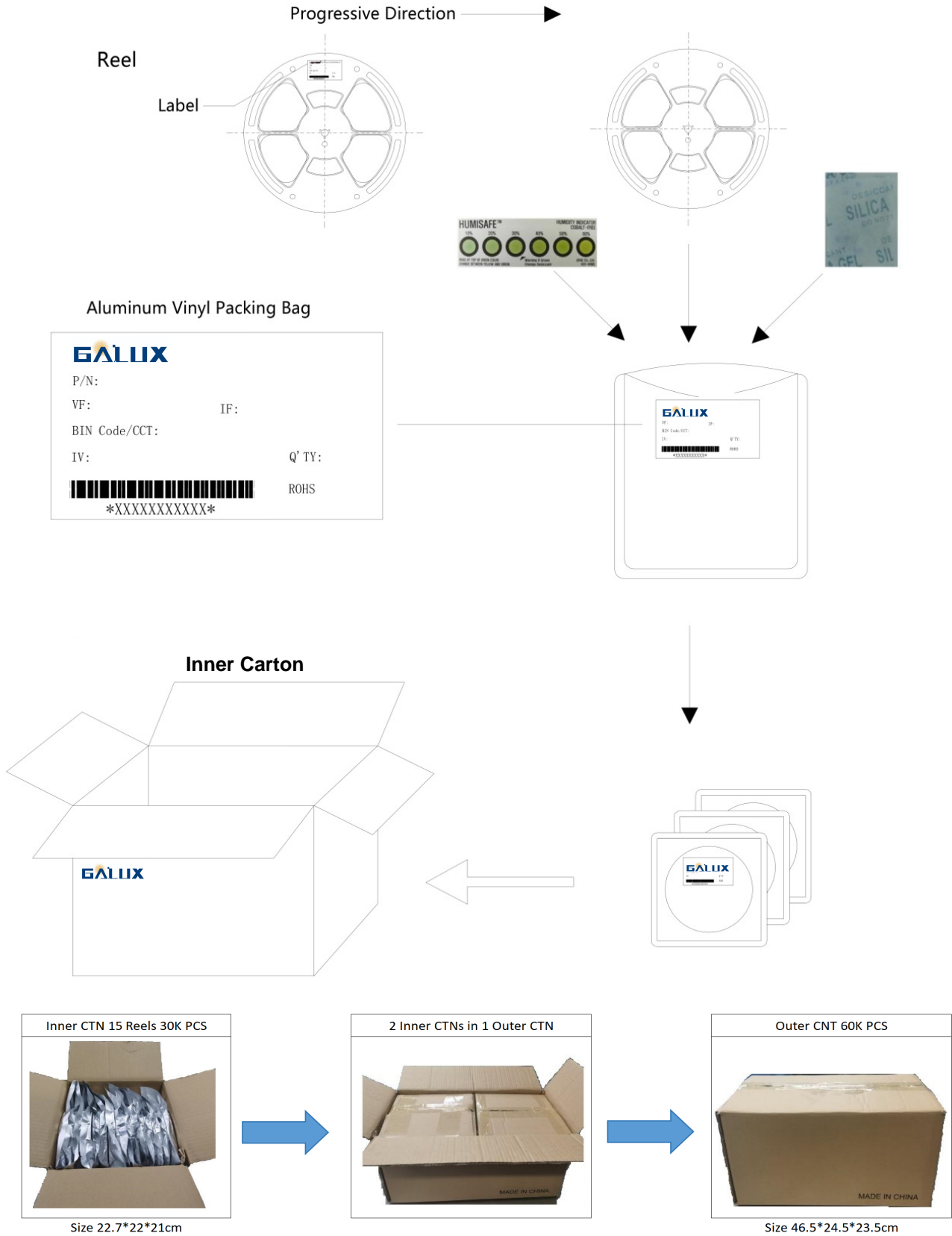

b) Aluminum Vinyl Packing Bag



c) Silica Gel & Humidity Indicator Card inside Aluminum Vinyl Bag

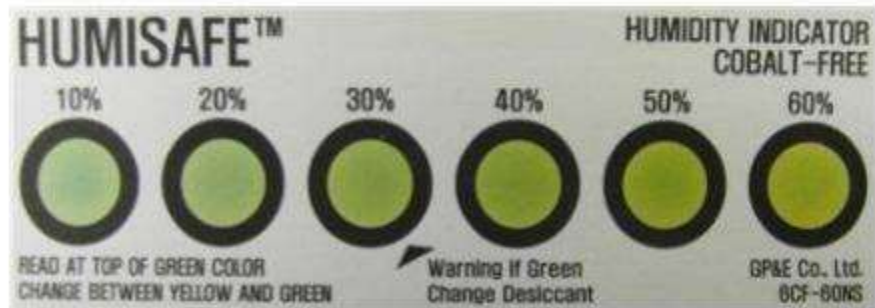

### 10. Precautions in Handling & Use

- 1) For over-current protection, users are recommended to apply resistors connected in series with the LEDs to mitigate sudden change of the forward current caused by shift of forward voltage.
- 2) This device should not be used in any type of fluid such as water, oil, organic solvent, etc. When cleaning is required, IPA is recommended as the cleaning agent. Some solvent-based cleaning agent may damage the silicone resins used in the device.
- 3) When the device is in operation, the forward current should be carefully determined considering the maximum ambient temperature and corresponding junction temperature.
- 4) LEDs must be stored in a clean environment. If the LEDs are to be stored for three months or more after being shipped from Led star, they should be packed with a nitrogen-filled container (shelf life of sealed bags is 12 months at temperature 0~40 °C, 0~90 % RH).
- 5) After storage bag is opened, device subjected to soldering, solder reflow, or other high temperature processes must be:
  - a. Mounted within 672 hours (28 days) at an assembly line with a condition of no more than 30 °C / 60 % RH\* Note 1, or
  - b. Mounted within 24 hours (1 day) at an assembly line with a condition of more than 30 °C / 70 % RH\* Note 2, or
  - c. Stored at <10 % RH.

Package Type and Body Thickness	Moisture Sensitivity Level	Maximum Percent Relative Humidity						Temperature
		40%	50%	60%	70%	80%	90%	
Body Thickness ≤2.1mm	Level 2a	∞	∞	28	1	1	1	30°C
		∞	∞	∞	2	1	1	25°C
		∞	∞	∞	2	2	1	20°C

- 6) Repack unused devices with anti-moisture packing, fold to close any opening and then store in a dry place.
- 7) Devices require baking before mounting, if humidity card reading is >60 % at 23 ± 5 °C.
- 8) Devices must be baked for 10~24 hours at 70 ± 5 °C, if baking is required.
- 9) The LEDs are sensitive to the static electricity and surge current. It is recommended to use a wrist band or anti-electrostatic glove when handling the LEDs. If voltage exceeding the absolute maximum rating is applied to LEDs, it may cause damage or even destruction to LED devices. Damaged LEDs may show some unusual characteristics such as increase in leakage current, lowered turn-on voltage, or abnormal lighting of LEDs at low current.
- 10) VOCs (Volatile Organic Compounds) can be generated from adhesives, flux, hardener or organic additives used in luminaries (fixtures). Transparent LED silicone encapsulant is permeable to those chemicals and they may lead to a discoloration of encapsulant when they exposed to heat or light. This phenomenon can cause a significant loss of light emitted (output) from the luminaries. In order to prevent these problems, we recommend users to know the physical properties of materials used in luminaries and they must be carefully selected.
- 11) Risk of sulfurization (or tarnishing)
 

The LED from Led star uses a silver-plated lead frame and its surface color may change to black (or dark colored) when it is exposed to sulfur (S), chlorine (Cl) or other halogen compound. Sulfurization of lead frame may cause intensity degradation, change of chromaticity coordinates and, in extreme cases, open circuit. It requires caution. Due to possible sulfurization of lead frame, LED should not be used and stored together with oxidizing substances made of materials such as rubber, plain paper, lead solder cream, etc