

PB Series Pushbutton Switches

Tiny

PB-02AK (LOCK TYPE)

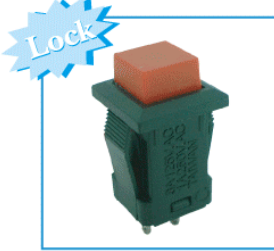

1A 250V AC
3A 125V AC

MODEL NO.	TYPE
PB-02AK	OFF ON Lock

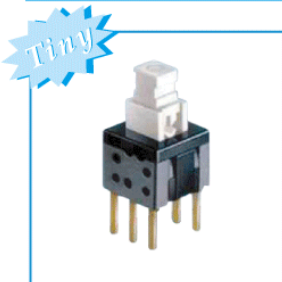
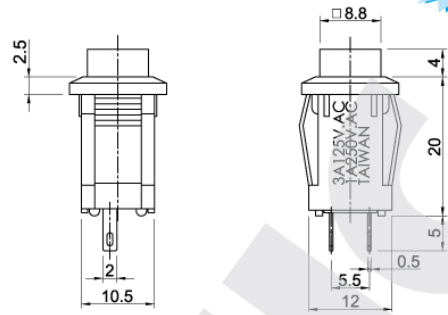
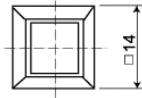

0.1A 30V DC

MODEL NO.	TYPE
MPS-580D	Lock
MPS-580ND	Non-lock

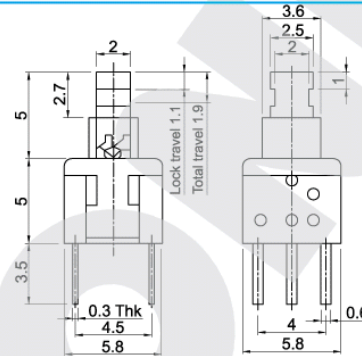

1. Rating : 0.1A 30V DC.
2. Circuit : DPDT
3. Contact resistance : 70mΩ.
4. Operating force : 180±50g.
5. Life : 10,000 Cycles.

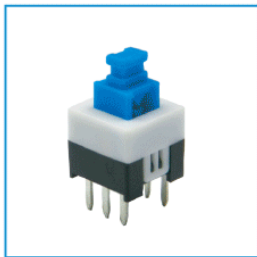

0.1A 30V DC

MODEL NO.	TYPE
MPS-700	Lock
MPS-700N	Non-lock

CAP C13

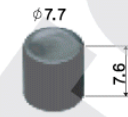

RED, BLACK

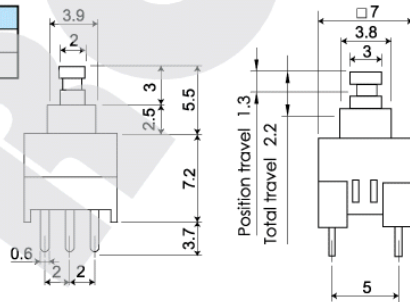

SCHMATIC

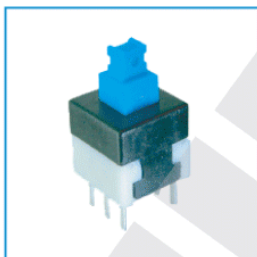
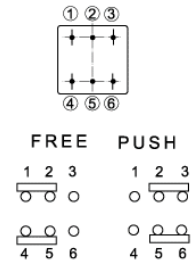

0.1A 30V DC

MODEL NO.	TYPE
MPS-800	Lock
MPS-800N	Non-lock
MPS-800V	Non-lock Click sound

CAP C13

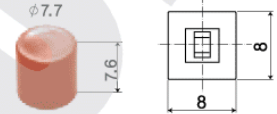

RED, BLACK

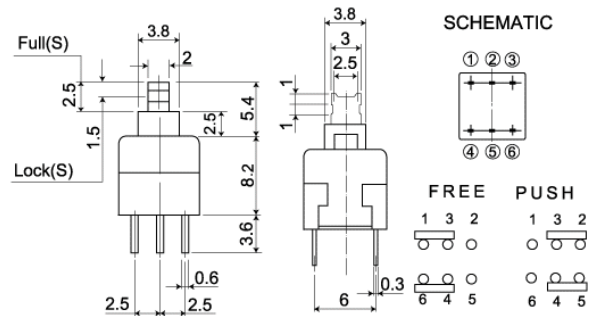

SCHMATIC

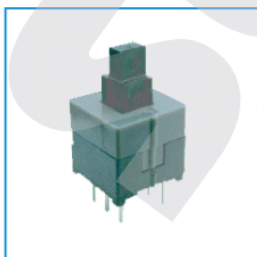
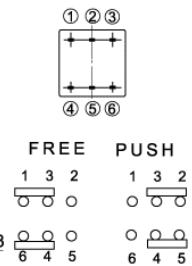

0.3A 30V DC

MODEL NO.	TYPE
MPS-850	Lock
MPS-850N	Non-lock
MPS-850V	Non-lock Click sound

CAP C13

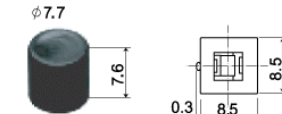

RED, BLACK

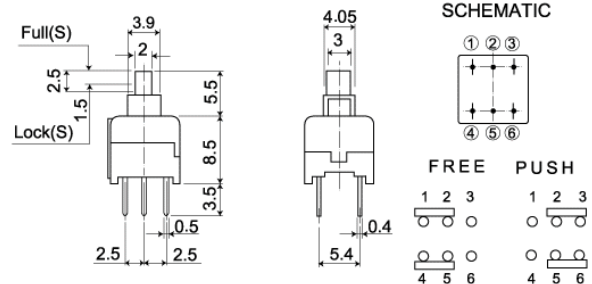

SCHMATIC

