

## 2835A03-XXS05-2P-F10-EC-LX

## Datasheet

## RD vision

This 2835 LED Light Source is a high performance energy efficient device which can handle high thermal and high driving current. The small package outline and high intensity make it an ideal choice for LED panel light, LED bulb light, LED tube light, backlighting and etc.

The White Power LED is available in the range of color temperature from 2600K to 7000K.

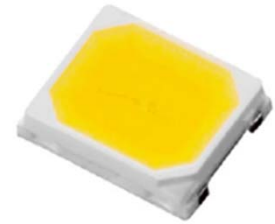

This part has a foot print that is compatible to most of the same size LED in the market today.

---

### FEATURES

- Available in Cool White, Neutral White and Warm White color
- ANSI-compatible chromaticity bins
- High luminous Intensity and high efficiency
- Low thermal resistance
- Long operation life
- Wide viewing angle at 120°
- Silicone encapsulation/
- Environmental friendly, RoHS compliance

---

### APPLICATIONS

- Flat panel light
- LED tube light
- LED bulb light/
- Decorative and landscape lighting
- Signage and channel letter
- Reading lamp
- Table lamp

Note: The information in this document is subject to change without notice.

## 2835A03-XXS05-2P-F10-EC-LX

2835	A	03	XX	H	05	2P	Fx
Package size	LM-80 report type	voltage	CCT	Ra	power	quantity of chips	Program code
2835	A:General report	03 : 3V	2700	L:<70	02 :0.2W	1S : 1 chip	.....
3030			3000	N:>70	05 :0.5W	2S : 2 chips in series	
4014	B:Individual report	06 : 6V	3500	H:>80	10 :1W	2P : 2 chips in parallel	
5050			4000	S:>90	.....	3S : 3 chips in series	
5630			5000	E:>95			
5730			5700				
			6000				
			6500				

PACKAGE DIMENSIONS

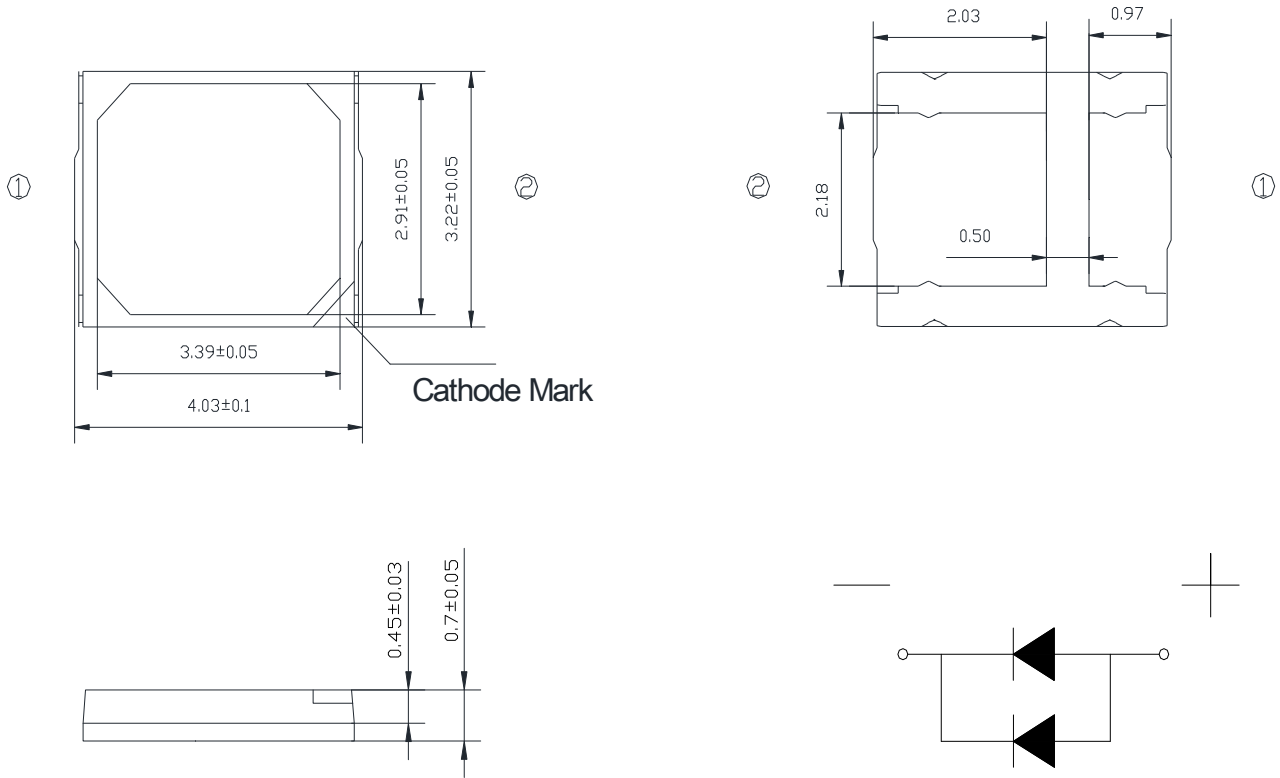

Recommended Solder Pad Design

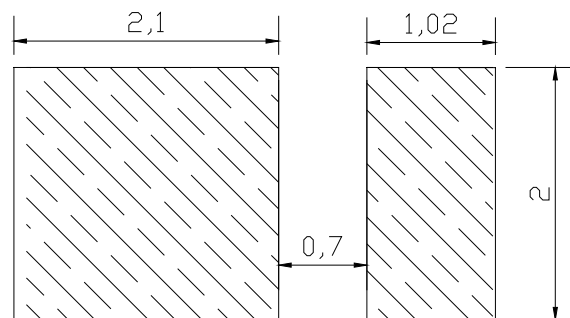

Notes/ :

1. All dimensions in millimeters
2. Thickness tolerance of copper plate is  $\pm 0.02$ mm.
3. Thickness tolerance of product is  $\pm 0.05$ mm.
4. Tolerance is  $\pm 0.1$ mm unless otherwise noted.

**ABSOLUTE MAXIMUM RATINGS**

Parameter	Symbol	Value	Unit
Forward current	IF	300	mA
Peak Forward Current	IFP	500	mA
Reverse Voltage	VR	5	V
Power Dissipation	Pd	500	mW
Operating Temperature	Topr	-40~+85	°C
Storage Temperature	Tstg	-40~+100	°C
Soldering Temperature	Tsld	Reflow Soldering: 260°C for 10 seconds	
LED Junction Temperature	Tj	115	°C

**ELECTRO-OPTICAL CHARACTERISTICS (Ta=25°C)**

Parameter	Symbol	Test Condition	Min	Typ	Max	Unit
Forward Voltage	$V_F$	IF=150mA	2.8	--	3.1	V
Viewing Angle	$2\theta_{1/2}$	IF=150mA	--	120	--	deg.
Luminous Flux	$\Phi_v$	IF=150mA	53	--	65	lm
Color Rendering Index	CRI	IF=150mA	90	--	--	--
Color Temperature	CCT	IF=150mA	2600	--	7000	K
Thermal Resistance	$R_{th-js}$	IF=150mA	--	20	--	°C/W

Notes 注:

1. Luminous flux is measured with an accuracy of  $\pm 5\%$ .
2. Chromaticity coordinate bins are measured with an accuracy of  $\pm 0.01$ .
3. CRI is measured with an accuracy of  $\pm 2$
4. Some color and CRI bins may have limited availability, please contact us before ordering.
5. All measurements were made under the standardized environment of Shineon

RELATIVE SPECTRAL POWER DISTRIBUTION ( $T_j=25^\circ\text{C}$ )

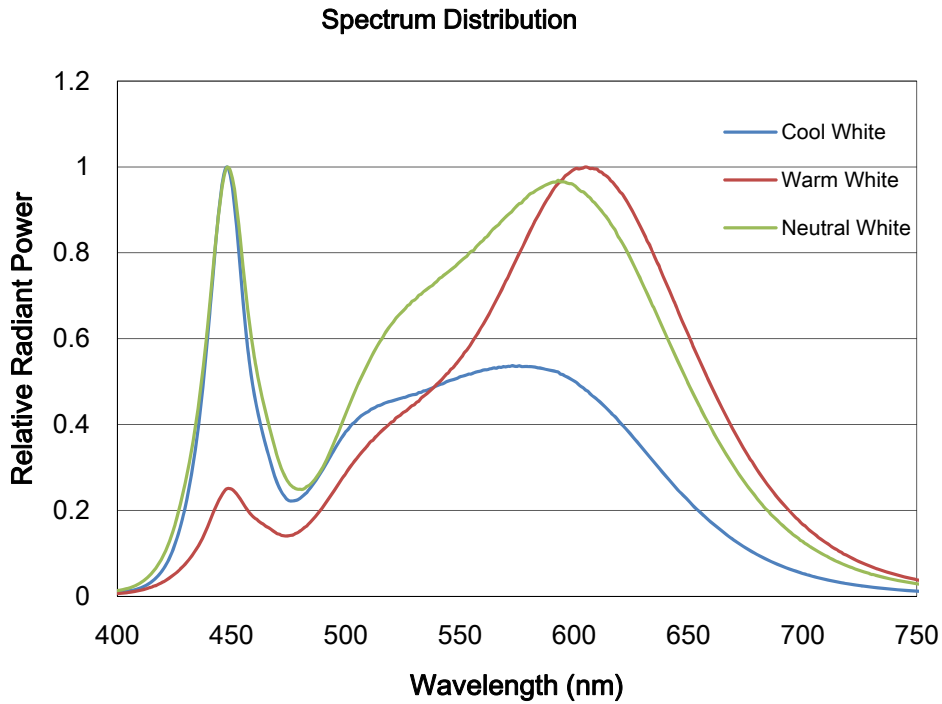

TYPICAL SPATIAL DISTRIBUTION

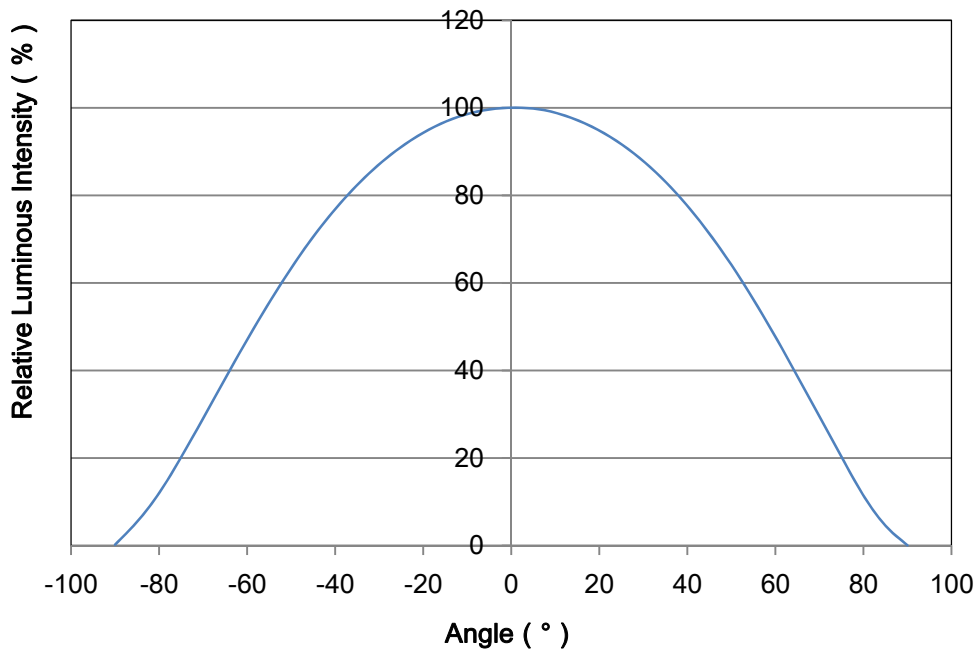

**RELATIVE LUMINOUS FLUX VS. CURRENT ( $T_j=25^\circ\text{C}$ )**

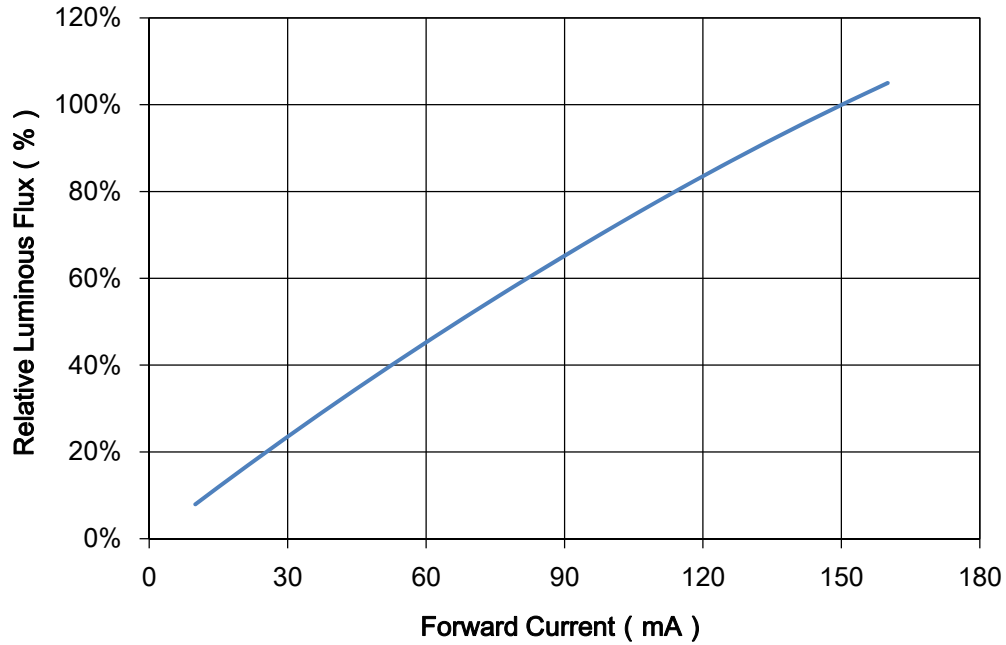

**ELECTRICAL CHARACTERISTICS ( $T_j=25^\circ\text{C}$ )**

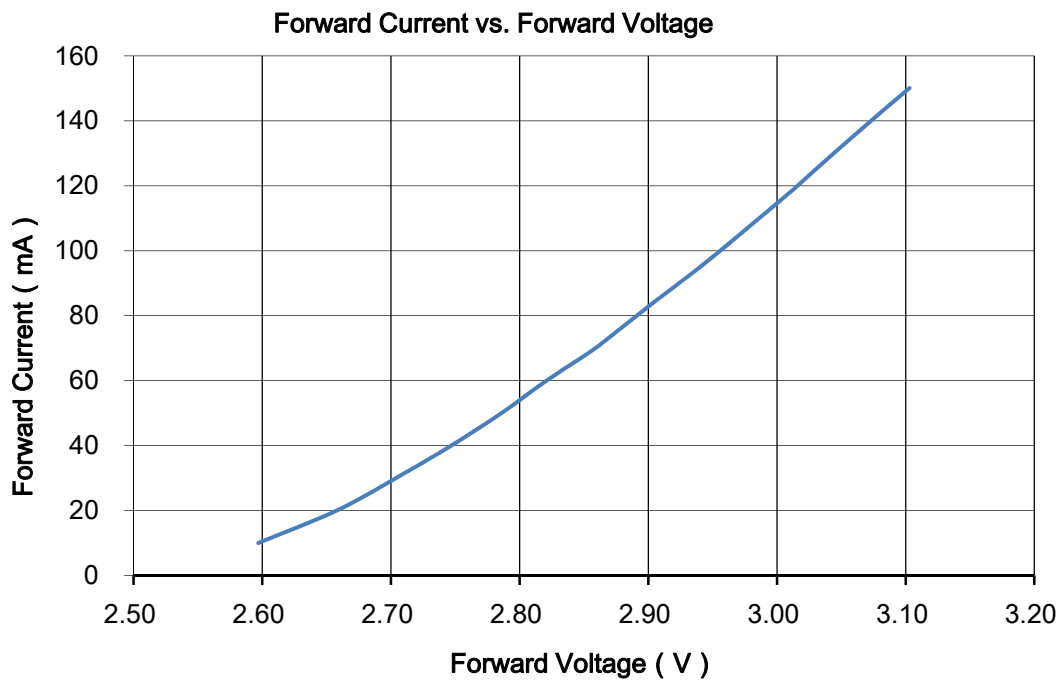

MAXIMUM CURRENT VS. AMBIENT TEMPERATURE

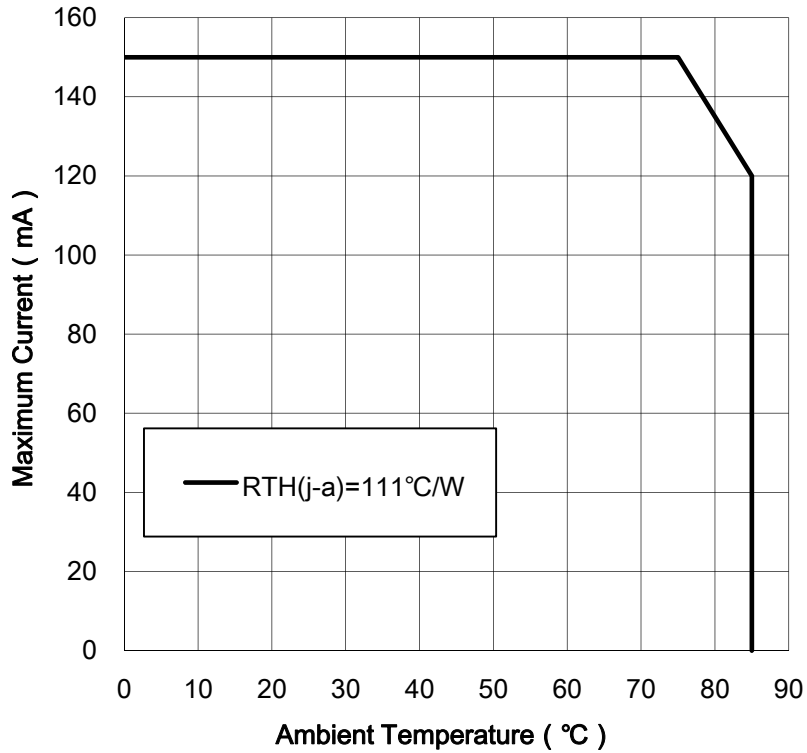

RELATIVE RADIANT FLUX VS. JUNCTION TEMPERATURE

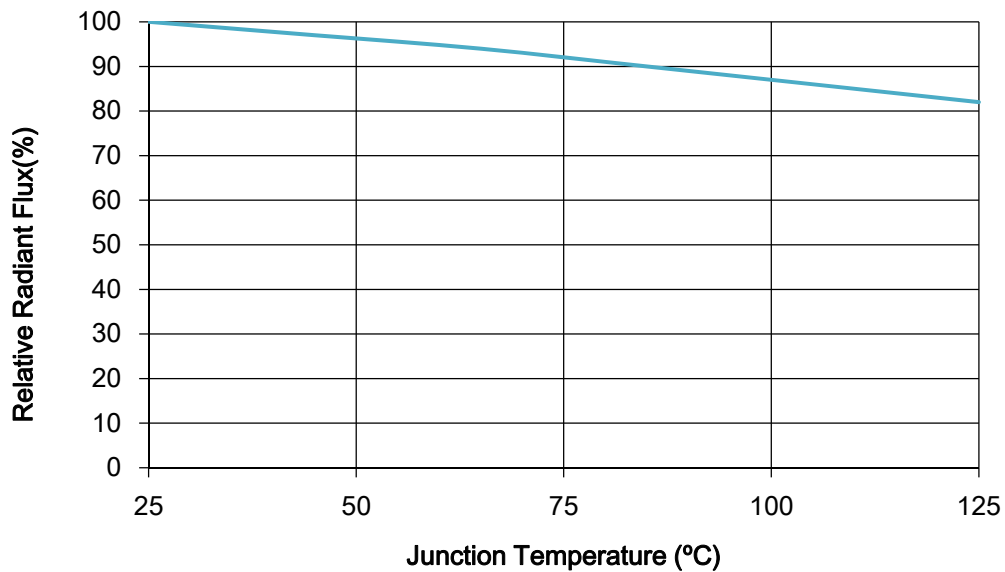

**SORTING RANKS**
**(1) Luminous Flux T<sub>j</sub>=25°C**

Part Number	Condition	Rank	Unit
2835A03-27S05-2P-F10-EC-LX	150mA	P03	lm
		53-58	
2835A03-30S05-2P-F10-EC-LX		P1	
		55-60	
2835A03-40S05-2P-F10-EC-LX		P2	
		60-65	
2835A03-50S05-2P-F10-EC-LX		P2	
		60-65	
2835A03-57S05-2P-F10-EC-LX		P2	
		60-65	
2835A03-65S05-2P-F10-EC-LX		P2	
		60-65	

**(2) Forward Voltage T<sub>j</sub>=25°C**

Rank	Condition	Min.	Max.	Unit
A8	150mA	2.8	2.9	V
A9		2.9	3.0	
B0		3.0	3.1	

Notes 注：

1. 5% tolerance for luminous intensity may be caused by measurement inaccuracy.
2. Measurement Uncertainty of the Forward Voltage : ± 0.1



(3) Chromaticity Bins

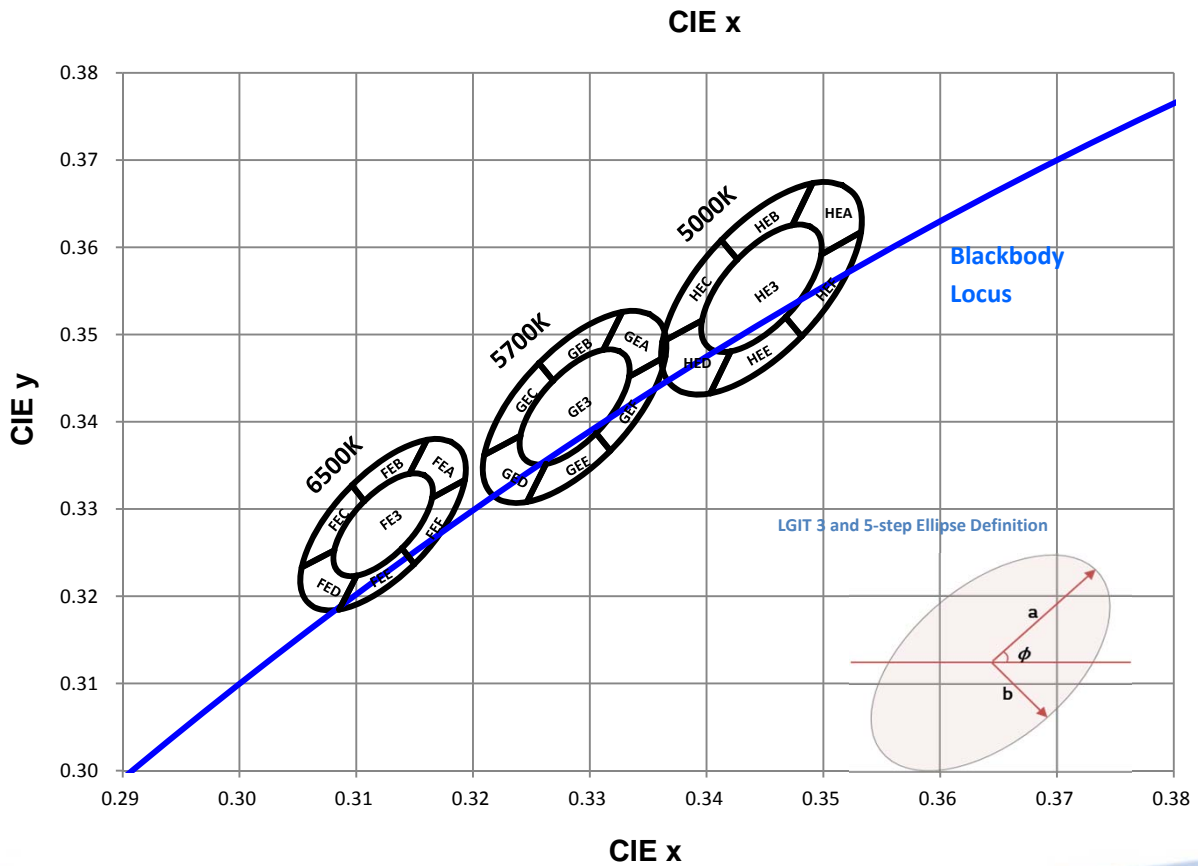
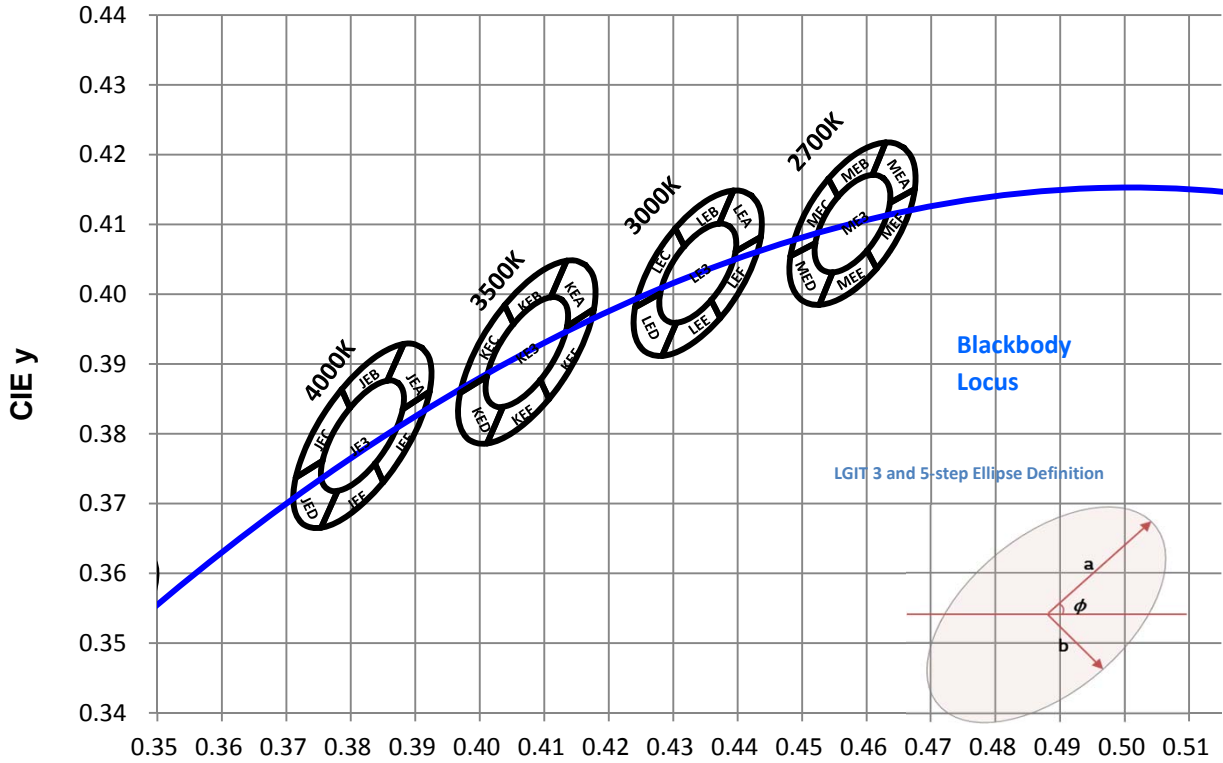

## (3) Chromaticity Bins

Nominal CCT (Rank)	Steps	Center Point		Major Axis	Minor Axis	Rotation Angle
		Cx	Cy	a	b	$\phi$
2700K (ME3)	3	0.4578	0.4101	0.00810	0.00420	53.70
2700K (MEA~MEF)	5			0.01350	0.00700	
3000K (LE3)	3	0.4338	0.4030	0.00834	0.00408	53.22
3000K (LEA~LEF)	5			0.01390	0.00680	
3500K (KE3)	3	0.4073	0.3917	0.00927	0.00414	54.00
3500K (KEA~KEF)	5			0.01545	0.00690	
4000K (JE3)	3	0.3818	0.3797	0.00939	0.00402	53.72
4000K (JEA~JEF)	5			0.01565	0.00670	

MEA		MEB		MEC		MED		MEE		MEF	
Cx	Cy	Cx	Cy	Cx	Cy	Cx	Cy	Cx	Cy	Cx	Cy
0.4675	0.4151	0.4629	0.4217	0.4541	0.4165	0.4482	0.4054	0.4527	0.3985	0.4615	0.4037
0.4636	0.4131	0.4609	0.4171	0.4556	0.4140	0.4520	0.4073	0.4547	0.4031	0.4600	0.4062
0.4629	0.4217	0.4541	0.4165	0.4482	0.4054	0.4527	0.3985	0.4615	0.4037	0.4675	0.4151
0.4609	0.4171	0.4556	0.4140	0.4520	0.4073	0.4547	0.4031	0.4600	0.4062	0.4636	0.4131

LEA		LEB		LEC		LED		LEE		LEF	
Cx	Cy	Cx	Cy	Cx	Cy	Cx	Cy	Cx	Cy	Cx	Cy
0.4436	0.4082	0.4393	0.4148	0.4303	0.4094	0.4241	0.3981	0.4283	0.3912	0.4373	0.3966
0.4397	0.4061	0.4371	0.4101	0.4317	0.4069	0.4280	0.4001	0.4305	0.3959	0.4359	0.3991
0.4393	0.4148	0.4303	0.4094	0.4241	0.3981	0.4283	0.3912	0.4373	0.3966	0.4436	0.4082
0.4371	0.4101	0.4317	0.4069	0.4280	0.4001	0.4305	0.3959	0.4359	0.3991	0.4397	0.4061

KEA		KEB		KEC		KED		KEE		KEF	
Cx	Cy	Cx	Cy	Cx	Cy	Cx	Cy	Cx	Cy	Cx	Cy
0.4177	0.3979	0.4135	0.4048	0.4039	0.3984	0.3970	0.3858	0.4011	0.3786	0.4107	0.3850
0.4135	0.3954	0.4110	0.3996	0.4052	0.3957	0.4011	0.3882	0.4036	0.3838	0.4094	0.3877
0.4135	0.4048	0.4039	0.3984	0.3970	0.3858	0.4011	0.3786	0.4107	0.3850	0.4177	0.3979
0.4110	0.3996	0.4052	0.3957	0.4011	0.3882	0.4036	0.3838	0.4094	0.3877	0.4135	0.3954

### (3) Chromaticity Bins

JEA		JEB		JEC		JED		JEE		JEF	
Cx	Cy	Cx	Cy	Cx	Cy	Cx	Cy	Cx	Cy	Cx	Cy
0.3922	0.3860	0.3882	0.3929	0.3786	0.3863	0.3715	0.3737	0.3754	0.3665	0.3850	0.3731
0.3880	0.3835	0.3856	0.3876	0.3799	0.3837	0.3756	0.3761	0.3780	0.3718	0.3837	0.3757
0.3882	0.3929	0.3786	0.3863	0.3715	0.3737	0.3754	0.3665	0.3850	0.3731	0.3922	0.3860
0.3856	0.3876	0.3799	0.3837	0.3756	0.3761	0.3780	0.3718	0.3837	0.3757	0.3880	0.3835

Nominal CCT (Rank)	Steps	Center Point		Major Axis	Minor Axis	Rotation Angle
		Cx	Cy	a	b	$\phi$
5000K (HE3)	3	0.3447	0.3553	0.00822	0.00354	59.62
5000K (HEA~HEF)	5			0.01370	0.00590	
5700K (GE3)	3	0.3287	0.3417	0.00746	0.00320	59.09
5700K (GEA~GEF)	5			0.01243	0.00533	
6500K (FE3)	3	0.3123	0.3282	0.00669	0.00285	58.57
6500K (FEA~FEF)	5			0.01115	0.00475	

HEA		HEB		HEC		HED		HEE		HEF	
Cx	Cy	Cx	Cy	Cx	Cy	Cx	Cy	Cx	Cy	Cx	Cy
0.3532	0.3617	0.3491	0.3673	0.3413	0.3608	0.3362	0.3492	0.3403	0.3433	0.3481	0.3498
0.3498	0.3592	0.3473	0.3625	0.3426	0.3586	0.3396	0.3516	0.3421	0.3481	0.3468	0.3520
0.3491	0.3673	0.3413	0.3608	0.3362	0.3492	0.3403	0.3433	0.3481	0.3498	0.3532	0.3617
0.3473	0.3625	0.3426	0.3586	0.3396	0.3516	0.3421	0.3481	0.3468	0.3520	0.3498	0.3592

GEA		GEB		GEC		GED		GEE		GEF	
Cx	Cy	Cx	Cy	Cx	Cy	Cx	Cy	Cx	Cy	Cx	Cy
0.3365	0.3475	0.3328	0.3526	0.3256	0.3467	0.3210	0.3362	0.3246	0.3308	0.3318	0.3367
0.3334	0.3452	0.3311	0.3482	0.3269	0.3447	0.3241	0.3384	0.3263	0.3352	0.3305	0.3387
0.3328	0.3526	0.3256	0.3467	0.3210	0.3362	0.3246	0.3308	0.3318	0.3367	0.3365	0.3475
0.3311	0.3482	0.3269	0.3447	0.3241	0.3384	0.3263	0.3352	0.3305	0.3387	0.3334	0.3452

FEA		FEB		FEC		FED		FEE		FEF	
Cx	Cy	Cx	Cy	Cx	Cy	Cx	Cy	Cx	Cy	Cx	Cy
0.3193	0.3333	0.3161	0.3379	0.3096	0.3327	0.3053	0.3233	0.3085	0.3185	0.3150	0.3237
0.3165	0.3313	0.3146	0.3340	0.3107	0.3309	0.3081	0.3253	0.3100	0.3224	0.3139	0.3255
0.3161	0.3379	0.3096	0.3327	0.3053	0.3233	0.3085	0.3185	0.3150	0.3237	0.3193	0.3333
0.3146	0.3340	0.3107	0.3309	0.3081	0.3253	0.3100	0.3224	0.3139	0.3255	0.3165	0.3313

TAPE AND REEL

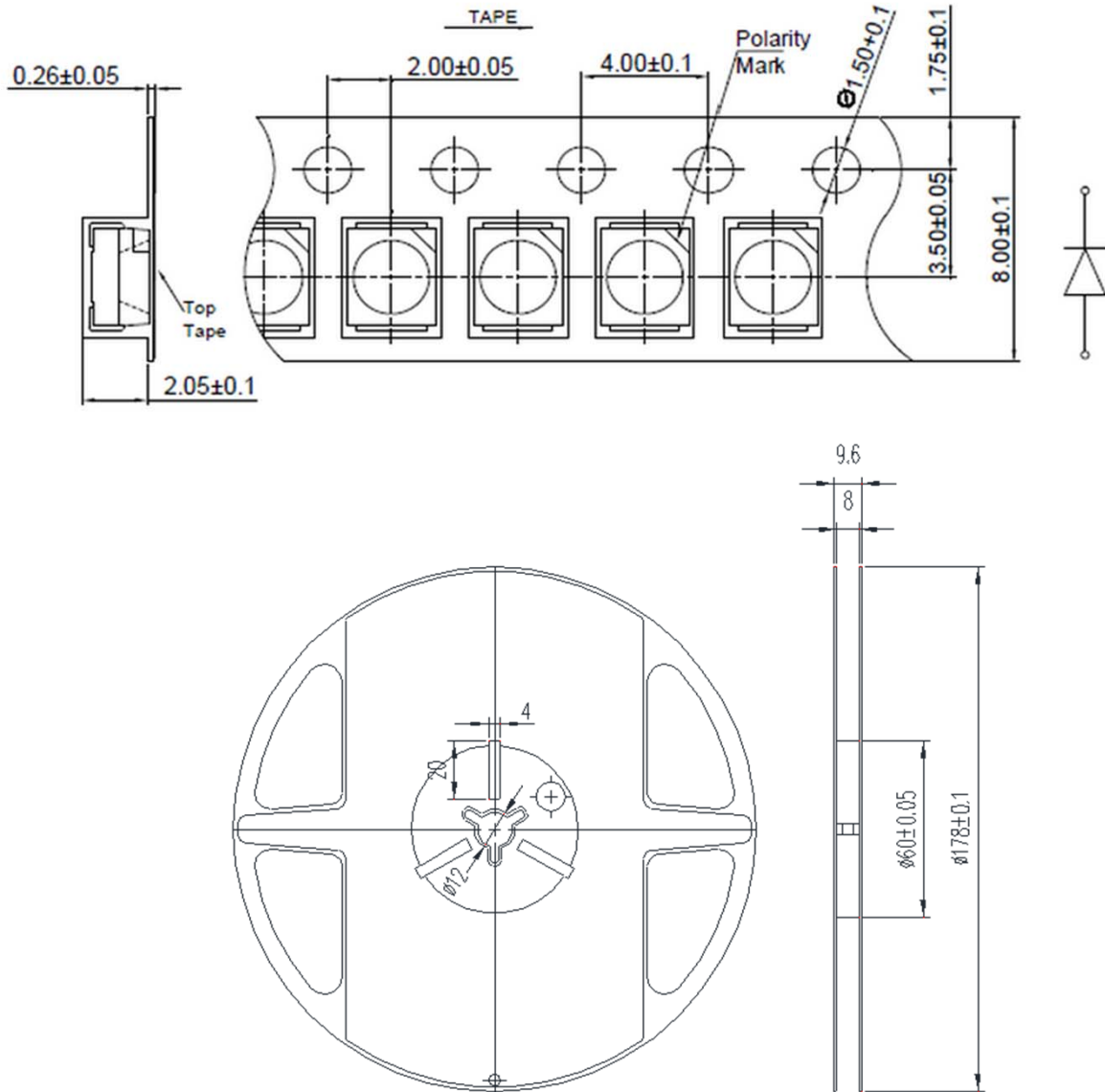







Note: The tolerances unless mentioned is  $\pm 0.1$ mm, Unit=mm

Notes注:

- (1) Quantity : 4,000pcs/Reel
- (2) Cumulative Tolerance : Cumulative Tolerance/10 pitches to be  $\pm 0.2$ mm
- (3) Adhesion Strength of Cover Tape : Adhesion strength to be 0.1-0.7N when the cover tape is turned off from the carrier tape at the angle of  $10^\circ$  to the carrier tape
- (4) Package : P/N, Manufacturing data Code No. and quantity to be indicated on a damp proof Package.

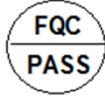
PACKAGING

Name:	PrdtName	 
		
Lot NO:	LotNo	
		
BinCode:	BinCode	
		Prd No: prd_no  Cus No: CUS_No Quantity: QtyPCS
IF:	IF	
VF:	VFV	
IV:	IVM	
RA:	RA	
CCT:	CCT	



REEL

Label

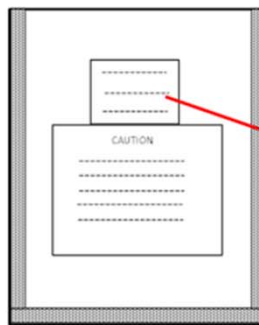

moisture-proof bag

Label

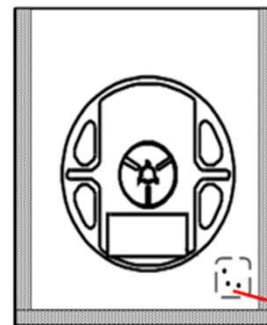

desiccant

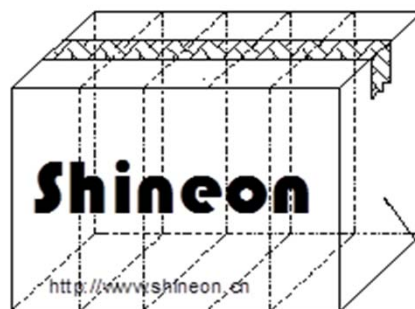

Outside box  
Maximums 48 Reels

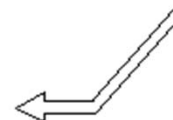

Reliability Test Items

Test Items 测试项目	Test Duration 测试时长	Number of Damaged 不良数
Steady State Operating Life of High Temperature (HTOL) Ts=85°C, IF=Max	1000hrs	0/20
Steady State Operating Life of Low Temperature (LTOL) Ta=-40°C, IF=Max	1000hrs	0/20
Pulse Wet Operating Life of High Temperature (PWHTOL) 60°C/90%RH, IF30mins ON/30min OFF	500hrs	0/20
High Temperature Storage (HTS) 100°C	1000hrs	0/20
Low Temperature Storage (LTS) -40°C	1000hrs	0/20
Thermal Shock (TS) -45°C~125°C 15min dwell 30sec transfer	100cycles	0/20
Solder Resistance (SR) 265°C, 3X MSL	5sec	0/20
Solder Ability (SA) 245°C 5sec, 95% coverage	5sec	0/11

Item	Symbol	Test Condition	Criteria for Judgment	
			Min.	Max.
Forward Voltage	Vf	IF=Typical Current		U.S.L x1.1
Luminous Flux	Im	IF=Typical Current	L.S.L x0.7	
CCX&CCY	x,y	IF=Typical Current		Shift<0.02

## REFLOW SOLDERING CHARACTERISTICS

### For Reflow Process :

Preheating : 140°C~160°C±5°C, within 2 minutes.

Operation heating: 260°C(Max.) within 10 seconds.(Max)

Gradual Cooling (Avoid quenching).

Lead solder		Lead-free solder	
Pre-heat	120-150°C	Pre-heat	150-200°C
Pre-heat time	120 sec.Max.	Pre-heat time	120 sec.Max.
Peak Temperature	240°C Max.	Peak Temperature	260°C Max.
Soldering time condition	10 sec.Max.	Soldering time condition	10 sec.Max.

Lead Solder	Lead-free Solder
 <p>The diagram for Lead Solder shows a reflow profile with the following parameters:           <ul style="list-style-type: none"> <li>Initial heating rate: 2.5-5 °C/sec.</li> <li>Pre-heating phase: 120-150°C, 120sec. Max.</li> <li>Heating rate to peak: 2.5-5 °C/sec.</li> <li>Peak temperature: 240 °C Max., 10 sec. Max.</li> <li>Soak time above 200°C: 60sec. Max.</li> <li>Cooling rate: 1-5 °C/sec.</li> </ul> </p>	 <p>The diagram for Lead-free Solder shows a reflow profile with the following parameters:           <ul style="list-style-type: none"> <li>Initial heating rate: 1-5 °C/sec.</li> <li>Pre-heating phase: 150-200 °C, 120sec. Max.</li> <li>Heating rate to peak: 1-5 °C/sec.</li> <li>Peak temperature: 260 °C Max., 10 sec. Max.</li> <li>Soak time above 220°C: 60sec. Max.</li> <li>Cooling rate: 1-5 °C/sec.</li> </ul> </p>

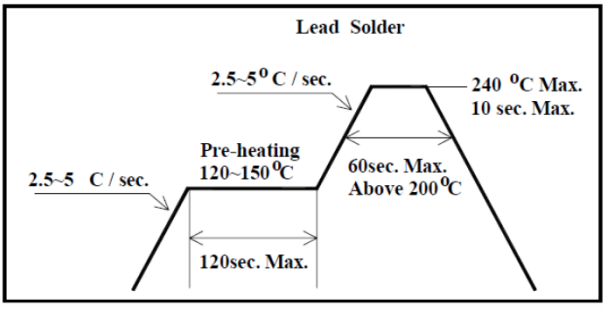
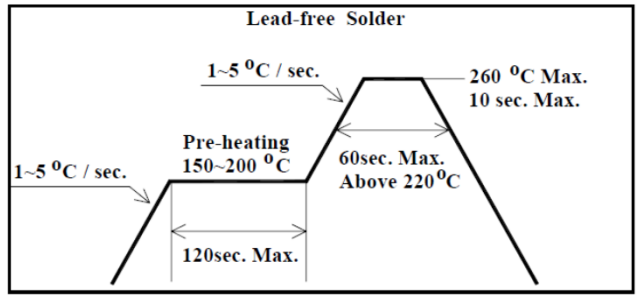
### Notes:

The encapsulated material of the LEDs is silicone . Therefore the LEDs have a soft surface on the top of package. The pressure to the top surface will be influence to the reliability of the LEDs. Precautions should be taken to avoid the strong pressure on the encapsulated part. So when using the picking up nozzle, the pressure on the silicone resin should be proper.

## PRECAUTION FOR USE

---

- (1) This device should not be used in any type of fluid such as water, oil, organic solvent, etc. When washing is required, IPA should be used.
- (2) When the LEDs are illuminating, operating current should be decided after considering the ambient maximum temperature.
- (3) LEDs must be stored to maintain a clean atmosphere. If the LEDs are stored for 3 months or more after being shipped from ShineOn, a sealed container with a nitrogen atmosphere should be used for storage.
- (4) The LEDs must be used within seven days after opening the moisture proof packing. Repack unused Products with anti-moisture packing, fold to close any opening and then store in a dry place.
- (5) The appearance and specifications of the product may be modified for improvement without notice.
- (6) This LED is sensitive to the static electricity and surge. It is recommended to use a wrist Band or anti-electrostatic glove when handling the LEDs.
- (7) On manual soldering, a solder tip must be needed as grounded for usage. If over voltage which exceeds the absolute maximum rating is applied to LEDs, it will cause damage LEDs and result in destruction. Damaged LEDs will show some unusual characteristics such as leak current remarkably increase ,turn-on voltage becomes lower and the LEDs get unlighted at low current.