

BROOKE-G2-W

~50° wide beam compatible with LEDiL HEKLA.

TECHNICAL SPECIFICATIONS:

Dimensions	Ø 45.0 mm
Height	18.9 mm
Fastening	socket
Colour	metal
Box size	480 x 280 x 300 mm
Box weight	5.2 kg
Quantity in Box	720 pcs
ROHS compliant	yes ⓘ



MATERIAL SPECIFICATIONS:

Component	Type	Material	Colour	Coating
BROOKE-G2-W	Reflector	PC	metal	lacquer

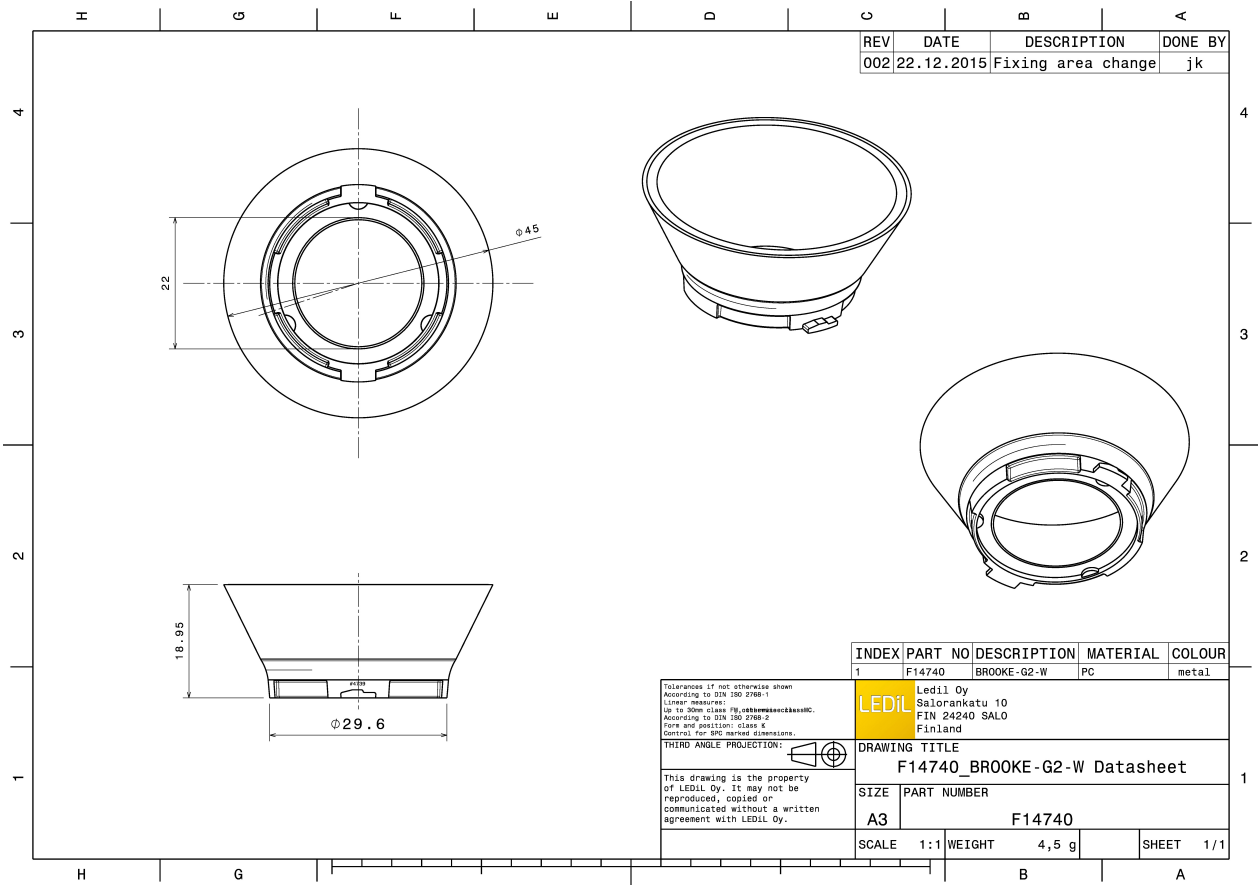

PHOTOMETRIC DATA (MEASURED):

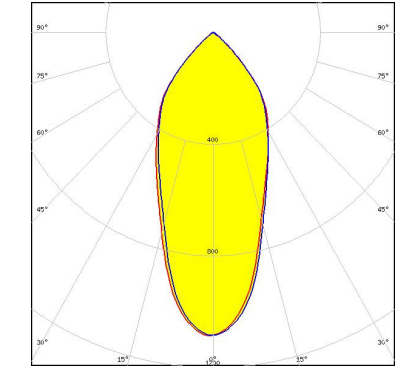
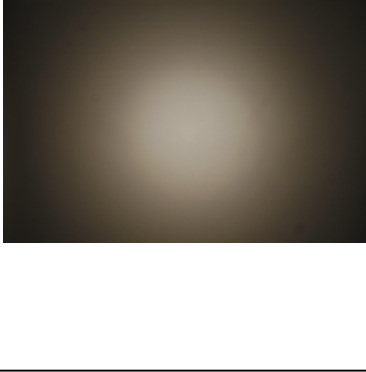
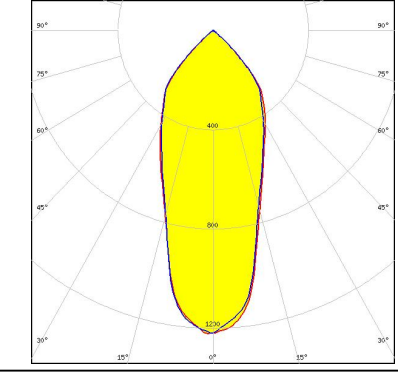
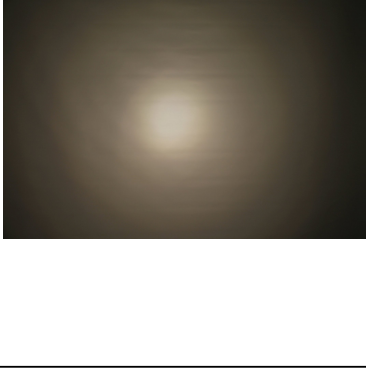
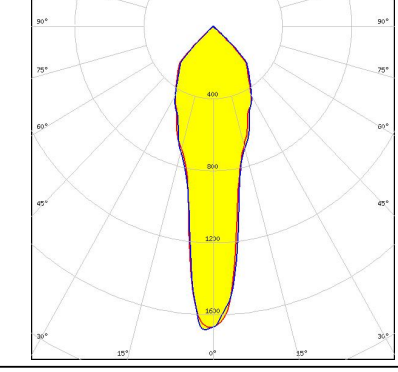
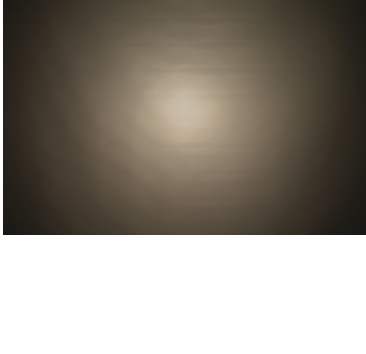
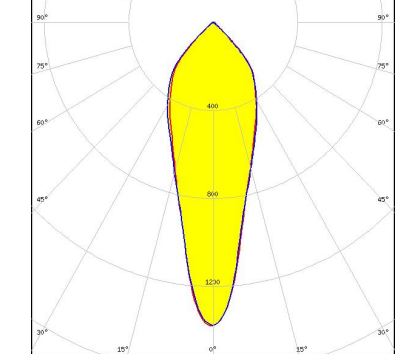
<p>bridgelux.</p> <p>LED V10 Gen7</p> <p>FWHM 44.0°</p> <p>Efficiency 88 %</p> <p>Peak intensity 1.100 cd/lm</p> <p>LEDs/each optic 1</p> <p>Light colour White</p> <p>Required components: F15255_HEKLA-SOCKET-C C14658_BARBARA-RZ-LENS</p>		
<p>bridgelux.</p> <p>LED V10 Gen7</p> <p>FWHM 40.0°</p> <p>Efficiency 94 %</p> <p>Peak intensity 1.200 cd/lm</p> <p>LEDs/each optic 1</p> <p>Light colour White</p> <p>Required components: F15255_HEKLA-SOCKET-C</p>		
<p>bridgelux.</p> <p>LED V4 HD</p> <p>FWHM 21.0°</p> <p>Efficiency 94 %</p> <p>Peak intensity 1.690 cd/lm</p> <p>LEDs/each optic 1</p> <p>Light colour White</p> <p>Required components: F15253_HEKLA-SOCKET-A</p>		
<p>bridgelux.</p> <p>LED V4 HD</p> <p>FWHM 30.0°</p> <p>Efficiency 89 %</p> <p>Peak intensity 1.830 cd/lm</p> <p>LEDs/each optic 1</p> <p>Light colour White</p> <p>Required components: F15253_HEKLA-SOCKET-A C14658_BARBARA-RZ-LENS</p>		

PHOTOMETRIC DATA (MEASURED):

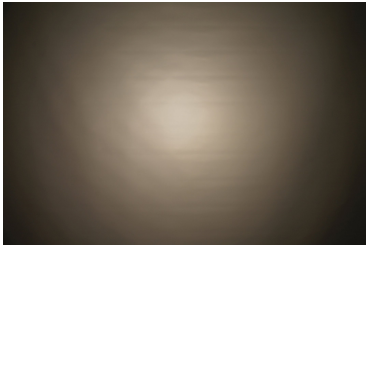
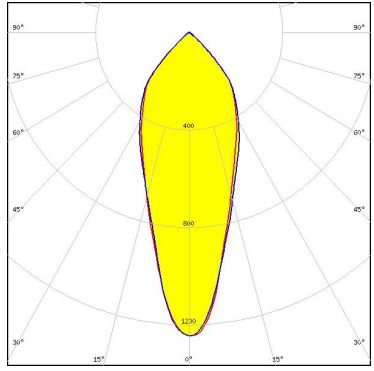
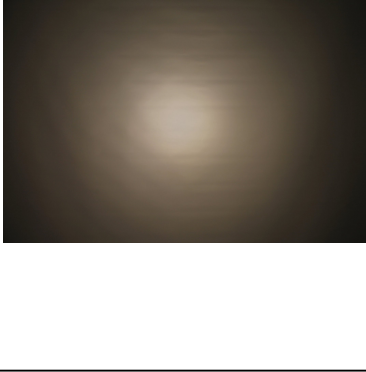
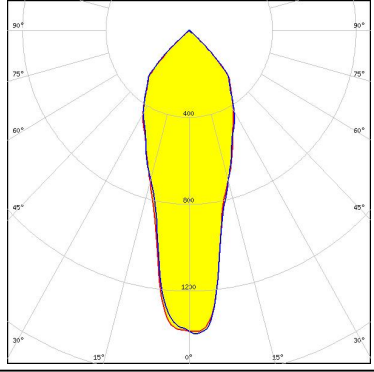
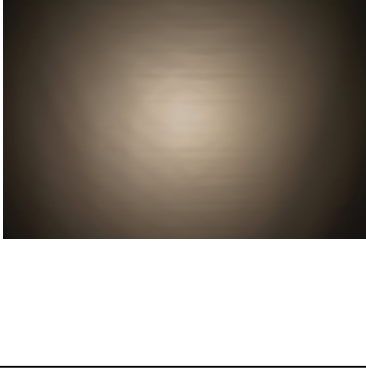
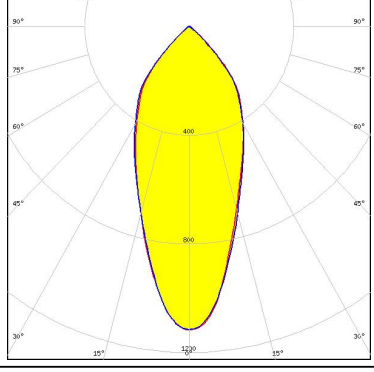
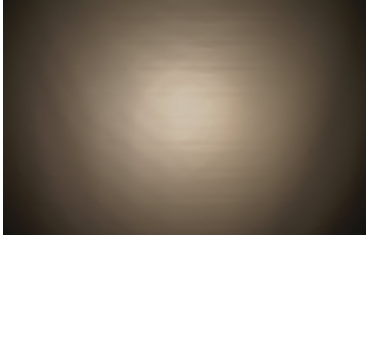
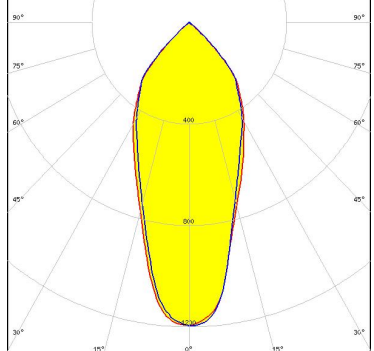
<p>bridgelux.</p> <p>LED V6 HD FWHM 36.0° Efficiency 88 % Peak intensity 1.250 cd/lm LEDs/each optic 1 Light colour White</p> <p>Required components: F15255_HEKLA-SOCKET-C C14658_BARBARA-RZ-LENS</p>		
<p>bridgelux.</p> <p>LED V6 HD FWHM 32.0° Efficiency 93 % Peak intensity 1.400 cd/lm LEDs/each optic 1 Light colour White</p> <p>Required components: F15255_HEKLA-SOCKET-C</p>		
<p>bridgelux.</p> <p>LED V9 HD FWHM 43.0° Efficiency 87 % Peak intensity 1.100 cd/lm LEDs/each optic 1 Light colour White</p> <p>Required components: F15859_HEKLA-SOCKET-I C14658_BARBARA-RZ-LENS</p>		
<p>bridgelux.</p> <p>LED V9 HD FWHM 42.0° Efficiency 93 % Peak intensity 1.200 cd/lm LEDs/each optic 1 Light colour White</p> <p>Required components: F15859_HEKLA-SOCKET-I</p>		

PHOTOMETRIC DATA (MEASURED):

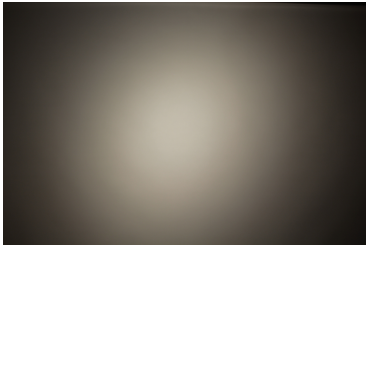
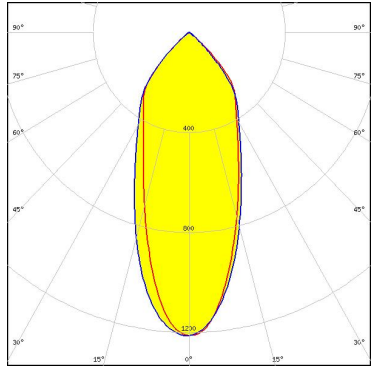
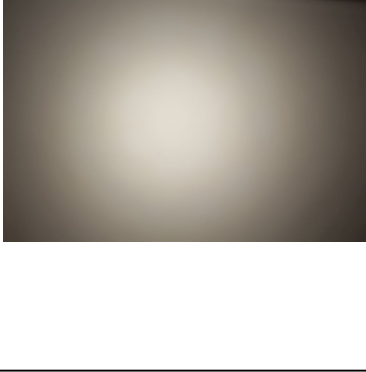
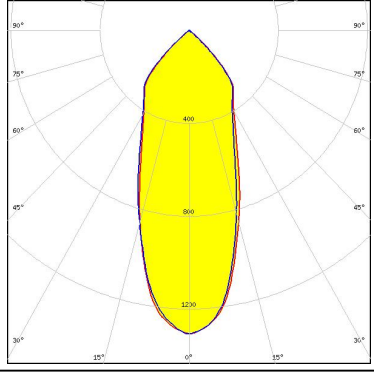
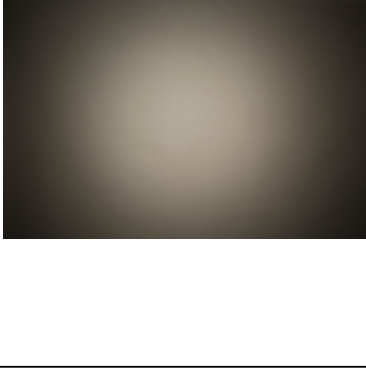
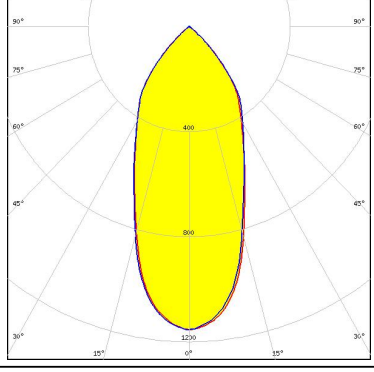
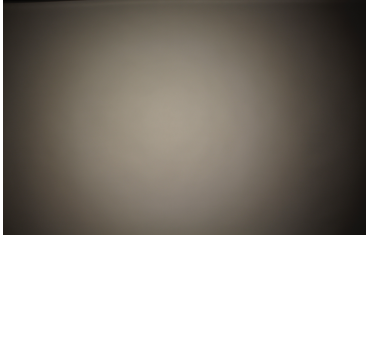
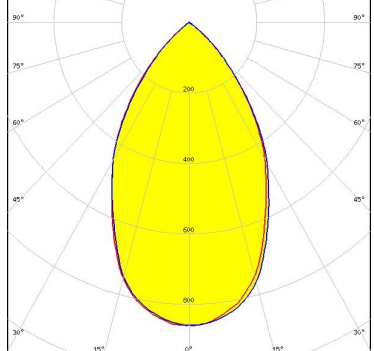
<p>bridgelux.</p> <p>LED VERO10 FWHM 41.0° Efficiency 92 % Peak intensity 1.200 cd/lm LEDs/each optic 1 Light colour White Required components: F15616_HEKLA-SOCKET-F C14658_BARBARA-RZ-LENS</p>		
<p>bridgelux.</p> <p>LED VERO10 FWHM 39.0° Efficiency 94 % Peak intensity 1.300 cd/lm LEDs/each optic 1 Light colour White Required components: F15616_HEKLA-SOCKET-F</p>		
<p>bridgelux.</p> <p>LED VERO13 FWHM 44.0° Efficiency 90 % Peak intensity 1.200 cd/lm LEDs/each optic 1 Light colour White Required components: C16142_HEKLA-SOCKET-K</p>		
<p>bridgelux.</p> <p>LED VERO18 FWHM 62.0° Efficiency 89 % Peak intensity 0.860 cd/lm LEDs/each optic 1 Light colour White Required components: C16142_HEKLA-SOCKET-K</p>		

PHOTOMETRIC DATA (MEASURED):

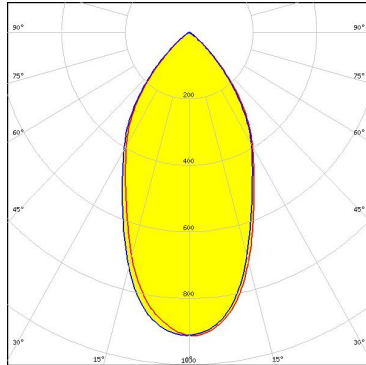
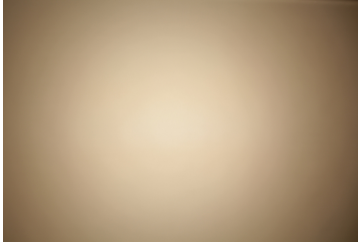
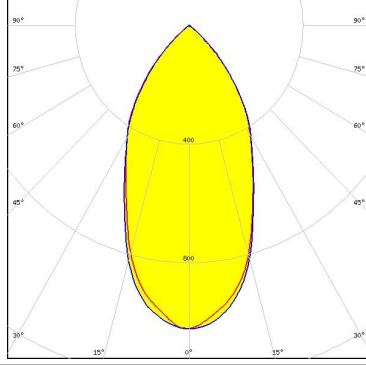
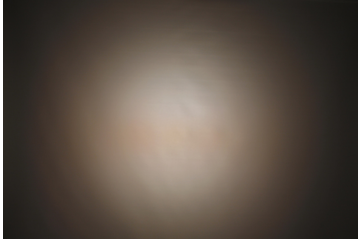
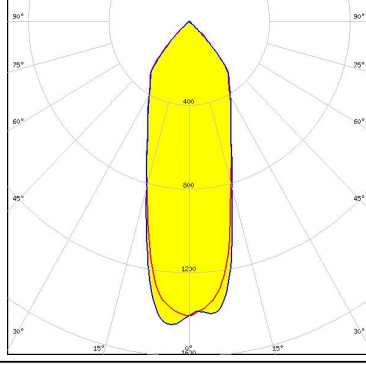
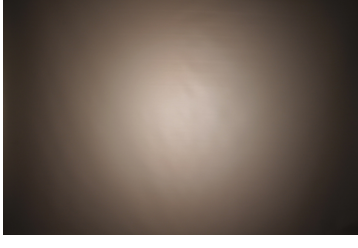
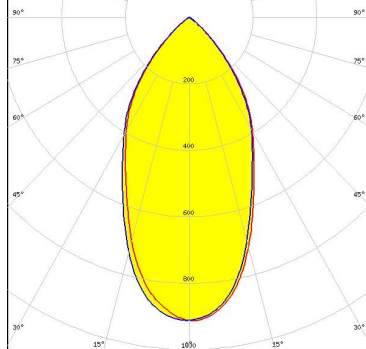
<p>bridgelux.</p> <p>LED Vesta DTW 15mm (33W) FWHM 53.0° Efficiency 83 % Peak intensity 0.900 cd/lm LEDs/each optic 1 Light colour White</p> <p>Required components: C16142_HEKLA-SOCKET-K C14658_BARBARA-RZ-LENS Bender Wirth: 491 Typ L8</p>		
<p>bridgelux.</p> <p>LED Vesta DTW 15mm (33W) FWHM 52.0° Efficiency 89 % Peak intensity 1.000 cd/lm LEDs/each optic 1 Light colour White</p> <p>Required components: C16142_HEKLA-SOCKET-K Bender Wirth: 491 Typ L8</p>		
<p>bridgelux.</p> <p>LED Vesta DTW 9mm (6W/12W) FWHM 34.0° Efficiency 90 % Peak intensity 1.500 cd/lm LEDs/each optic 1 Light colour White</p> <p>Required components: C16142_HEKLA-SOCKET-K Bender Wirth: 490 Typ L8</p>		
<p>bridgelux.</p> <p>LED Vesta DTW 9mm (6W/12W) FWHM 41.0° Efficiency 85 % Peak intensity 1.100 cd/lm LEDs/each optic 1 Light colour White</p> <p>Required components: C16142_HEKLA-SOCKET-K C14658_BARBARA-RZ-LENS Bender Wirth: 490 Typ L8</p>		

PHOTOMETRIC DATA (MEASURED):

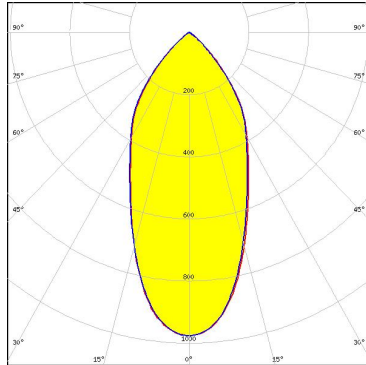
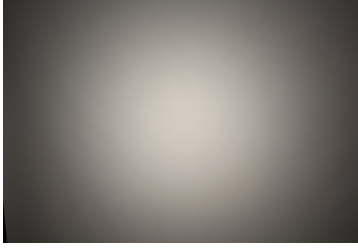
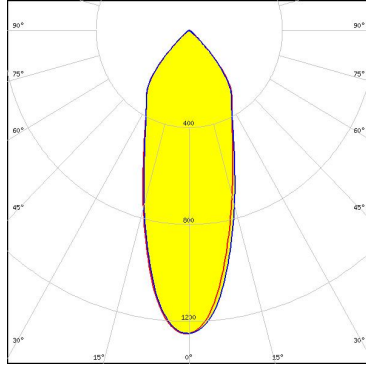
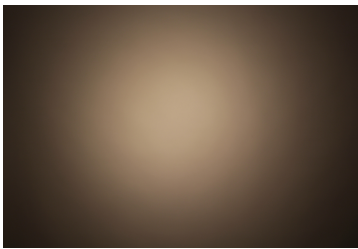
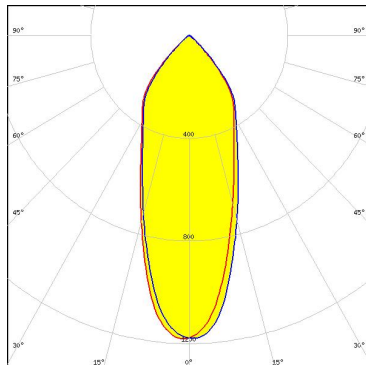
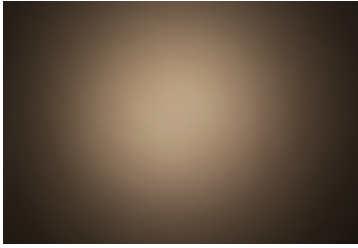
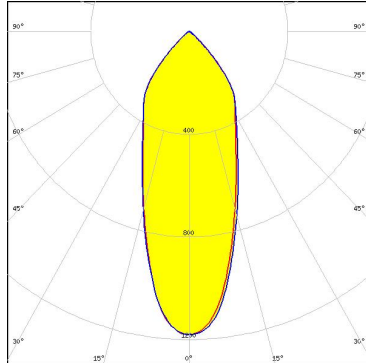
<p>bridgelux.</p> <p>LED Vesta TW 13mm (25W)</p> <p>FWHM 48.0°</p> <p>Efficiency 83 %</p> <p>Peak intensity 0.980 cd/lm</p> <p>LEDs/each optic 1</p> <p>Light colour White</p> <p>Required components: C16142_HEKLA-SOCKET-K C14658_BARBARA-RZ-LENS Bender Wirth: 492 Typ L8</p>		
<p>bridgelux.</p> <p>LED Vesta TW 9mm (12W)</p> <p>FWHM 36.0°</p> <p>Efficiency 84 %</p> <p>Peak intensity 1.300 cd/lm</p> <p>LEDs/each optic 1</p> <p>Light colour White</p> <p>Required components: C16142_HEKLA-SOCKET-K C14658_BARBARA-RZ-LENS Bender Wirth: 489 Typ L8</p>		
<p>CITIZEN</p> <p>LED CLC020 Series (Dim-To-Warm)</p> <p>FWHM 38.0°</p> <p>Efficiency 83 %</p> <p>Peak intensity 1.200 cd/lm</p> <p>LEDs/each optic 1</p> <p>Light colour White</p> <p>Required components: C16142_HEKLA-SOCKET-K C14658_BARBARA-RZ-LENS Bender Wirth: 487 Typ L8</p>		
<p>CITIZEN</p> <p>LED CLC020 Series (Dim-To-Warm)</p> <p>FWHM 38.0°</p> <p>Efficiency 83 %</p> <p>Peak intensity 1.200 cd/lm</p> <p>LEDs/each optic 1</p> <p>Light colour White</p> <p>Required components: C16142_HEKLA-SOCKET-K C14658_BARBARA-RZ-LENS Bender Wirth: 487 Typ L8</p>		

PHOTOMETRIC DATA (MEASURED):

CITIZEN

LED CLC030 Series (Dim-To-Warm)
 FWHM 49.0°
 Efficiency 87 %
 Peak intensity 1.000 cd/lm
 LEDs/each optic 1
 Light colour White
 Required components:
 C16142_HEKLA-SOCKET-K

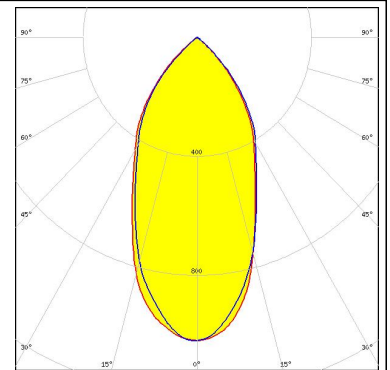

CITIZEN

LED CLC030 Series (Dim-To-Warm)
 FWHM 53.0°
 Efficiency 81 %
 Peak intensity 0.900 cd/lm
 LEDs/each optic 1
 Light colour White
 Required components:
 C16142_HEKLA-SOCKET-K
 C14658_BARBARA-RZ-LENS
 Bender Wirth: 436 Typ L8

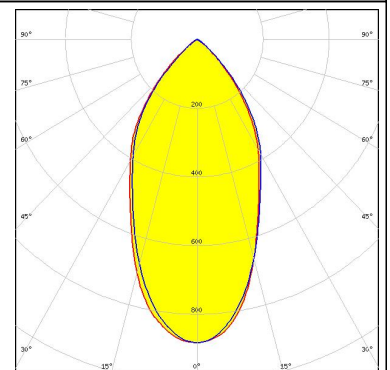
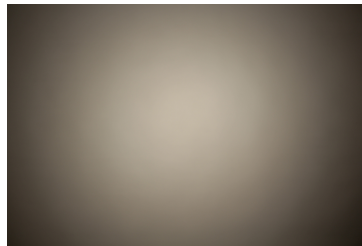

CITIZEN

LED CLU700/701
 FWHM 33.0°
 Efficiency 90 %
 Peak intensity 1.400 cd/lm
 LEDs/each optic 1
 Light colour White
 Required components:
 F15255_HEKLA-SOCKET-C
 C14658_BARBARA-RZ-LENS

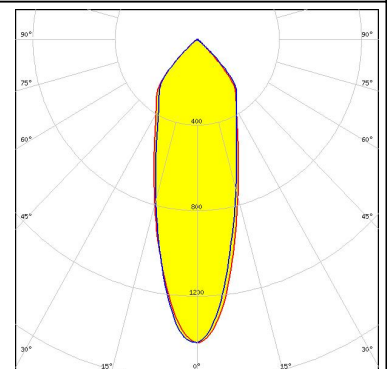
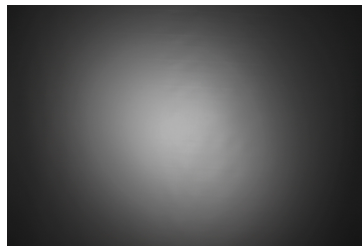

CITIZEN

LED CLU700/701
 FWHM 32.0°
 Efficiency 94 %
 Peak intensity 1.500 cd/lm
 LEDs/each optic 1
 Light colour White
 Required components:
 F15255_HEKLA-SOCKET-C

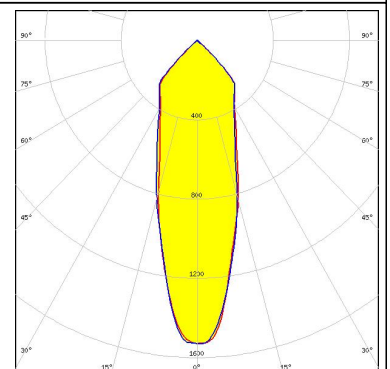
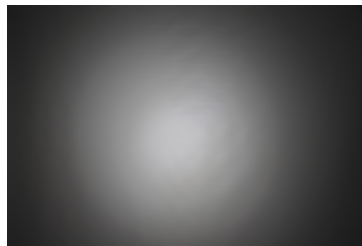

PHOTOMETRIC DATA (MEASURED):

CITIZEN

LED CLU7A2 (LES 4.2mm)
 FWHM 24.0°
 Efficiency 93 %
 Peak intensity 1.900 cd/lm
 LEDs/each optic 1
 Light colour White
 Required components:
 F15255_HEKLA-SOCKET-C

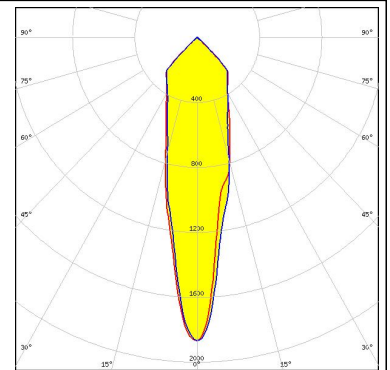

CITIZEN

LED LCN-C01B (Tunable White)
 FWHM 38.0°
 Efficiency 84 %
 Peak intensity 1.200 cd/lm
 LEDs/each optic 1
 Light colour White
 Required components:
 C16142_HEKLA-SOCKET-K
 C14658_BARBARA-RZ-LENS
 Bender Wirth: 481 Typ L8

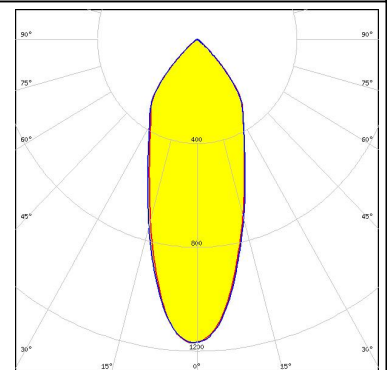
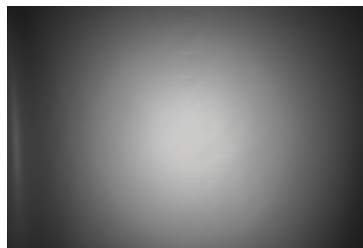

CITIZEN

LED LCN-C02B (Tunable White)
 FWHM 45.0°
 Efficiency 88 %
 Peak intensity 1.100 cd/lm
 LEDs/each optic 1
 Light colour White
 Required components:
 C16142_HEKLA-SOCKET-K

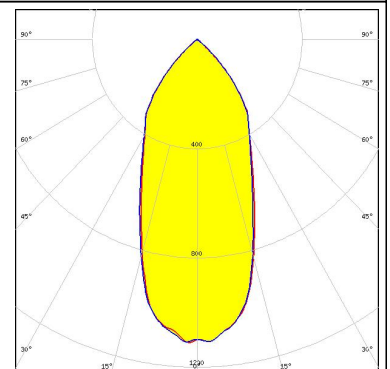
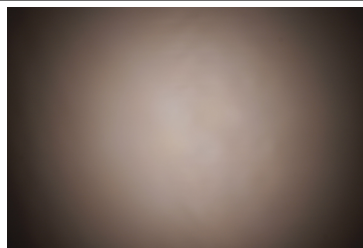

CITIZEN

LED LCN-C02B (Tunable White)
 FWHM 48.0°
 Efficiency 83 %
 Peak intensity 0.960 cd/lm
 LEDs/each optic 1
 Light colour White
 Required components:
 C16142_HEKLA-SOCKET-K
 C14658_BARBARA-RZ-LENS
 Bender Wirth: 481 Typ L8

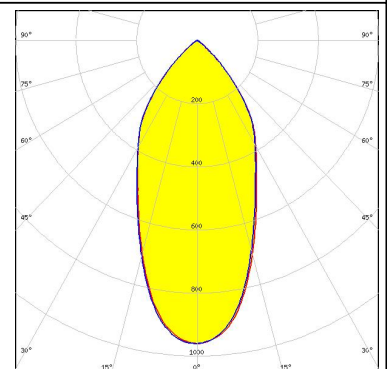
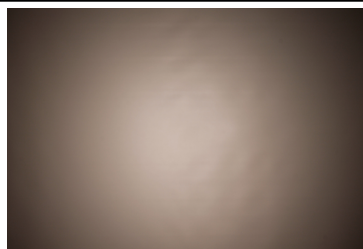

PHOTOMETRIC DATA (MEASURED):



LED CMA1516
 FWHM 45.0°
 Efficiency 93 %
 Peak intensity 1.100 cd/lm
 LEDs/each optic 1
 Light colour White
 Required components:
 F15256_HEKLA-SOCKET-D

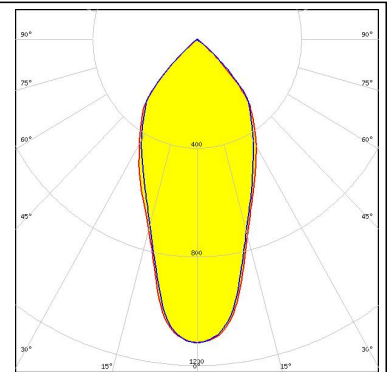

LED CMA1825
 FWHM 55.0°
 Efficiency 93 %
 Peak intensity 0.990 cd/lm
 LEDs/each optic 1
 Light colour White
 Required components:
 F15254_HEKLA-SOCKET-B

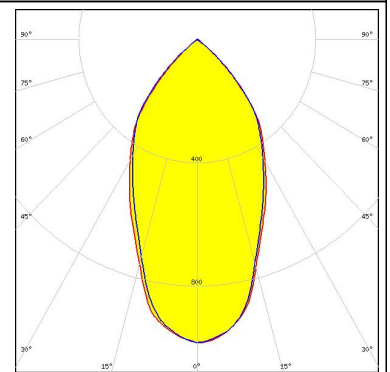
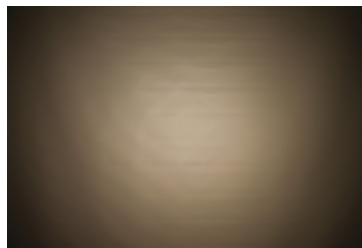

LED CMT14xx
 FWHM 45.0°
 Efficiency 93 %
 Peak intensity 1.100 cd/lm
 LEDs/each optic 1
 Light colour White
 Required components:
 F15255_HEKLA-SOCKET-C

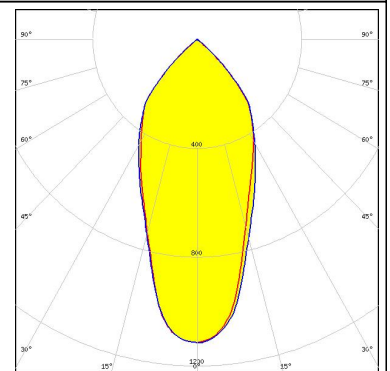
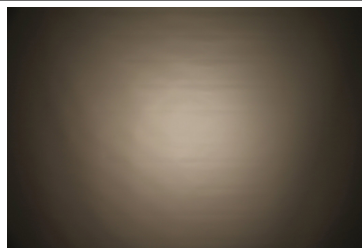

LED CXA/B 13xx
 FWHM 34.0°
 Efficiency 94 %
 Peak intensity 1.400 cd/lm
 LEDs/each optic 1
 Light colour White
 Required components:
 F15956_HEKLA-SOCKET-J

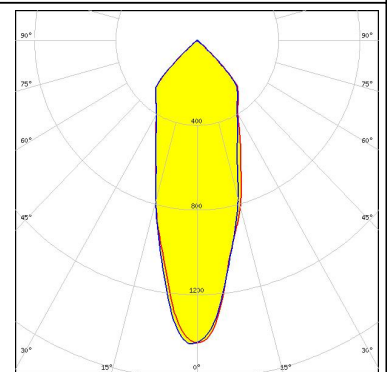
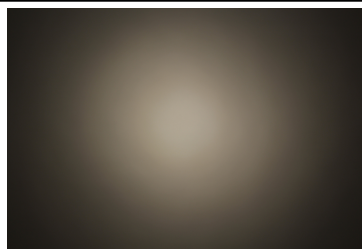

PHOTOMETRIC DATA (MEASURED):



LED CXA/B 15xx
 FWHM 41.0°
 Efficiency 93 %
 Peak intensity 1.200 cd/lm
 LEDs/each optic 1
 Light colour White
 Required components:
 F15256_HEKLA-SOCKET-D

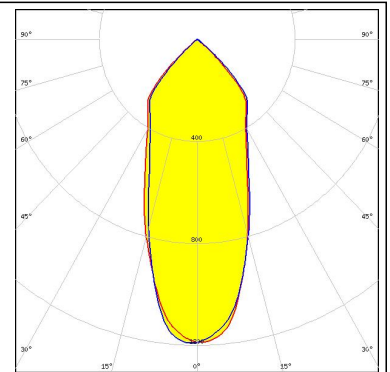
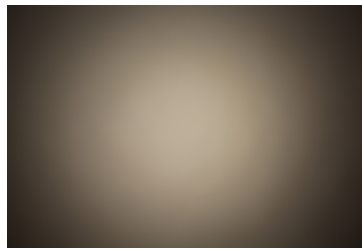

LED CDM-14 (Dim-To-Warm)
 FWHM 46.0°
 Efficiency 86 %
 Peak intensity 1.100 cd/lm
 LEDs/each optic 1
 Light colour White
 Required components:
 C16142_HEKLA-SOCKET-K
 Bender Wirth: 491 Typ L8

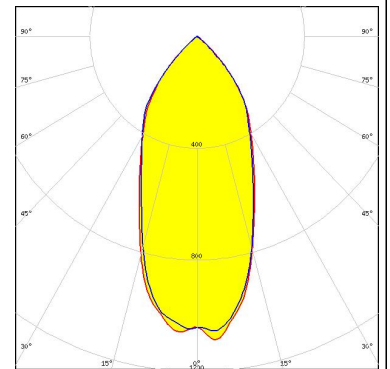
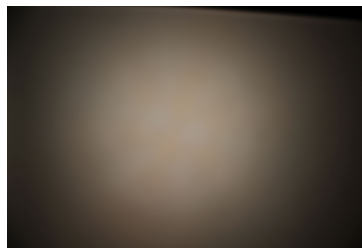

LED CDM-14 (Dim-To-Warm)
 FWHM 51.0°
 Efficiency 81 %
 Peak intensity 0.910 cd/lm
 LEDs/each optic 1
 Light colour White
 Required components:
 C16142_HEKLA-SOCKET-K
 C14658_BARBARA-RZ-LENS
 Bender Wirth: 491 Typ L8

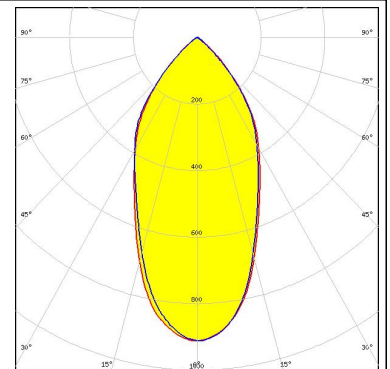
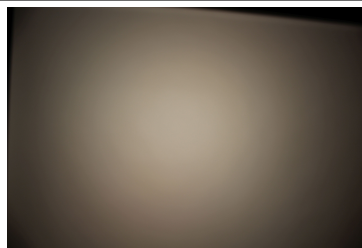

LED CDM-6 (Dim-To-Warm)
 FWHM 33.0°
 Efficiency 85 %
 Peak intensity 1.300 cd/lm
 LEDs/each optic 1
 Light colour White
 Required components:
 C16142_HEKLA-SOCKET-K
 C14658_BARBARA-RZ-LENS
 Bender Wirth: 490 Typ L8

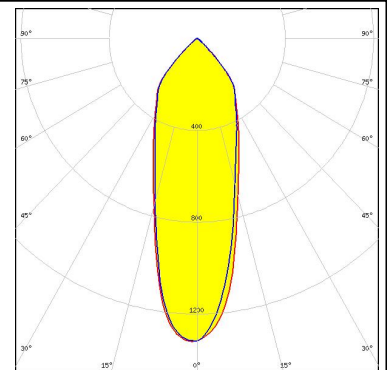
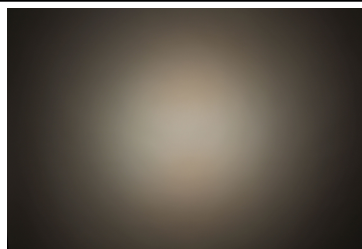

PHOTOMETRIC DATA (MEASURED):

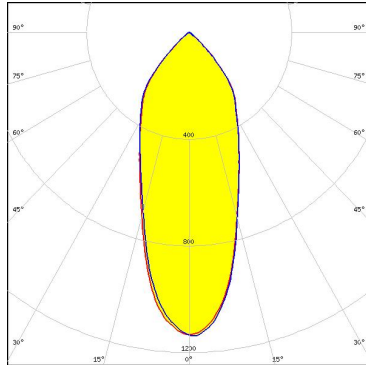
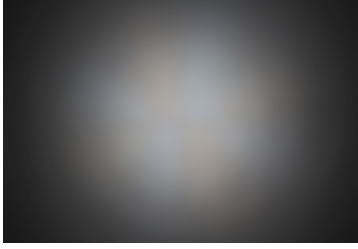
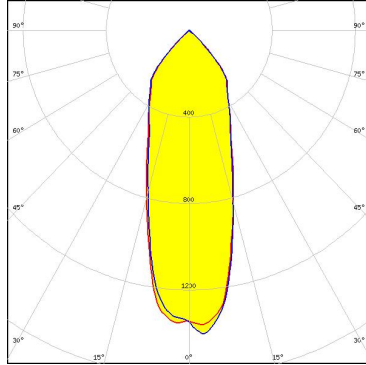
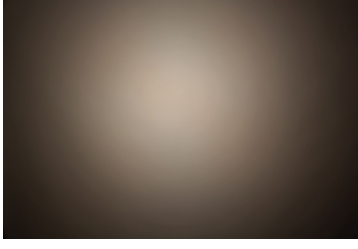
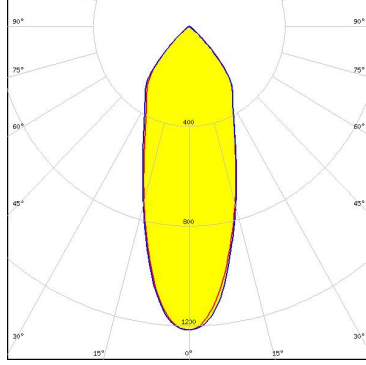
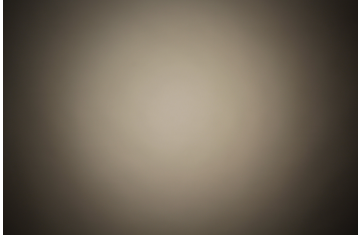
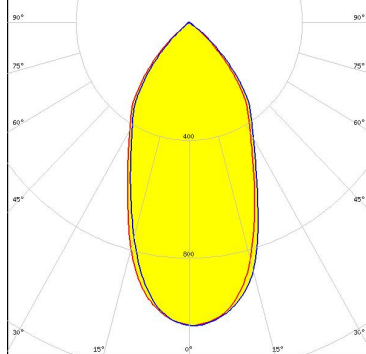
<p>LUMINUS</p> <p>LED CDM-9 (Dim-To-Warm)</p> <p>FWHM 40.0°</p> <p>Efficiency 84 %</p> <p>Peak intensity 1.100 cd/lm</p> <p>LEDs/each optic 1</p> <p>Light colour White</p> <p>Required components: C16142_HEKLA-SOCKET-K C14658_BARBARA-RZ-LENS Bender Wirth: 490 Typ L8</p>		
<p>LUMINUS</p> <p>LED CDM-9 (Dim-To-Warm)</p> <p>FWHM 35.0°</p> <p>Efficiency 88 %</p> <p>Peak intensity 1.500 cd/lm</p> <p>LEDs/each optic 1</p> <p>Light colour White</p> <p>Required components: C16142_HEKLA-SOCKET-K Bender Wirth: 490 Typ L8</p>		
<p>LUMINUS</p> <p>LED CTM-9 (Tunable White)</p> <p>FWHM 37.0°</p> <p>Efficiency 84 %</p> <p>Peak intensity 1.200 cd/lm</p> <p>LEDs/each optic 1</p> <p>Light colour White</p> <p>Required components: C16142_HEKLA-SOCKET-K C14658_BARBARA-RZ-LENS Bender Wirth: 495 Typ L8</p>		
<p>LUMINUS</p> <p>LED CXM-14</p> <p>FWHM 51.0°</p> <p>Efficiency 93 %</p> <p>Peak intensity 1.000 cd/lm</p> <p>LEDs/each optic 1</p> <p>Light colour White</p> <p>Required components: F15859_HEKLA-SOCKET-I</p>		

PHOTOMETRIC DATA (MEASURED):



LED CXM-9
 FWHM 43.0°
 Efficiency 94 %
 Peak intensity 1.200 cd/lm
 LEDs/each optic 1
 Light colour White
 Required components:
 F15255_HEKLA-SOCKET-C

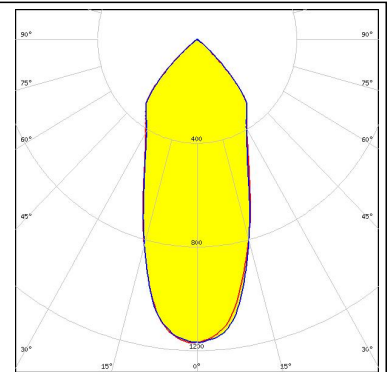
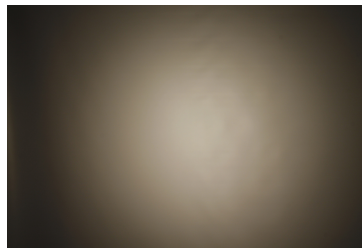

LED NJCWL024Z-V1MT: COB L-Type Tunable White
 FWHM 29.0°
 Efficiency 87 %
 Peak intensity 1.600 cd/lm
 LEDs/each optic 1
 Light colour White
 Required components:
 C16142_HEKLA-SOCKET-K
 Bender Wirth: 497 Typ L8

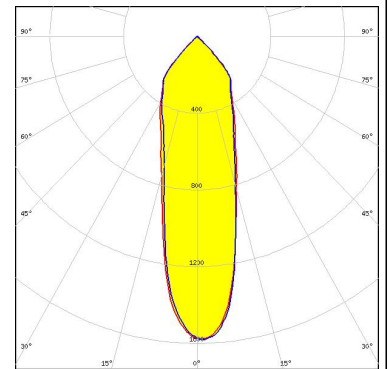
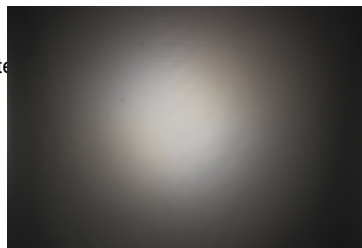



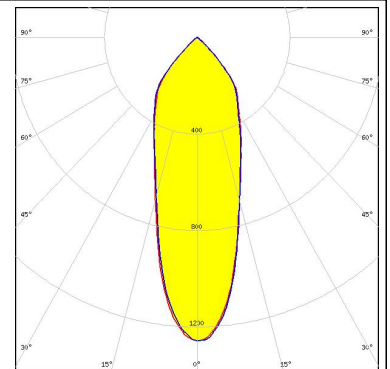
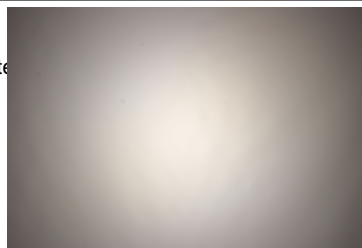

LED NJCWL024Z-V1MT: COB L-Type Tunable White
 FWHM 34.0°
 Efficiency 81 %
 Peak intensity 1.300 cd/lm
 LEDs/each optic 1
 Light colour White
 Required components:
 C16142_HEKLA-SOCKET-K
 C14658_BARBARA-RZ-LENS
 Bender Wirth: 497 Typ L8

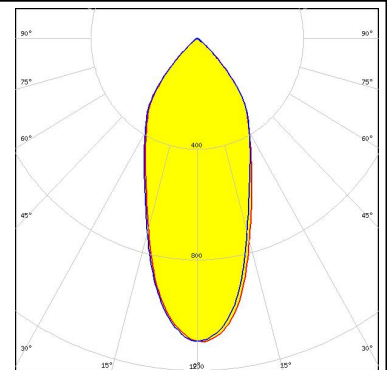
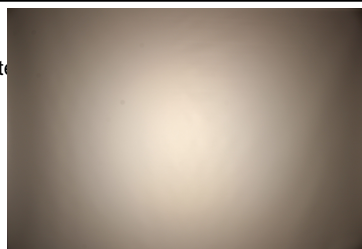

LED NVCWJ024Z-V1MT: COB J-Type Tunable White
 FWHM 43.0°
 Efficiency 84 %
 Peak intensity 1.100 cd/lm
 LEDs/each optic 1
 Light colour White
 Required components:
 C16142_HEKLA-SOCKET-K
 C14658_BARBARA-RZ-LENS
 Bender Wirth: 498 Typ L8

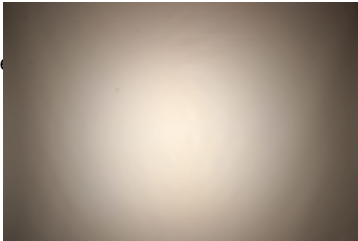
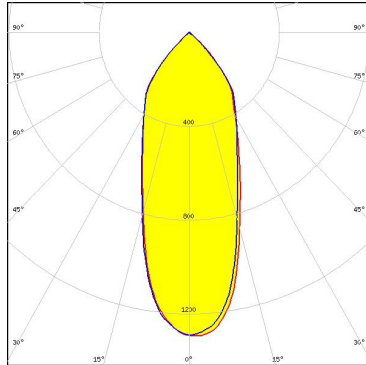
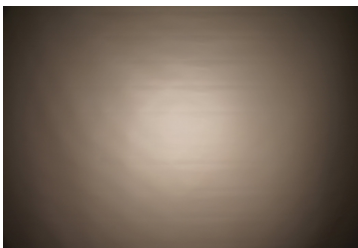
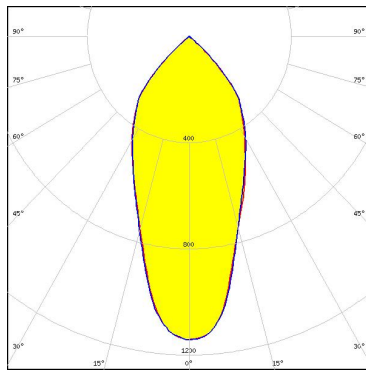

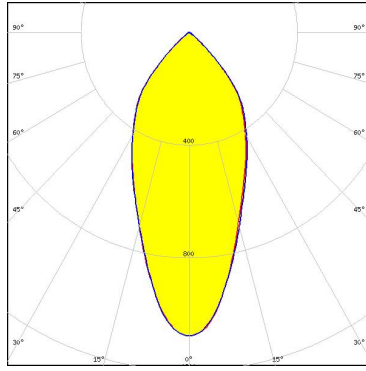
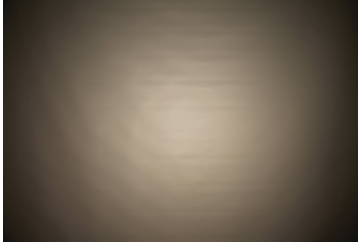
PHOTOMETRIC DATA (MEASURED):

<p>NICHIA</p> <p>LED NVCWJ024Z-V1MT: COB J-Type Tunable White</p> <p>FWHM 39.0°</p> <p>Efficiency 90 %</p> <p>Peak intensity 1.300 cd/lm</p> <p>LEDs/each optic 1</p> <p>Light colour White</p> <p>Required components: C16142_HEKLA-SOCKET-K Bender Wirth: 498 Typ L8</p>		
<p>PHILIPS</p> <p>LED Fortimo SLM L09 CoB</p> <p>FWHM 45.0°</p> <p>Efficiency 94 %</p> <p>Peak intensity 1.140 cd/lm</p> <p>LEDs/each optic 1</p> <p>Light colour White</p> <p>Required components: F15858_HEKLA-SOCKET-H</p>		
<p>PHILIPS</p> <p>LED Fortimo SLM L09 CoB</p> <p>FWHM 45.0°</p> <p>Efficiency 88 %</p> <p>Peak intensity 1.080 cd/lm</p> <p>LEDs/each optic 1</p> <p>Light colour White</p> <p>Required components: F15858_HEKLA-SOCKET-H C14658_BARBARA-RZ-LENS</p>		
<p>PHILIPS</p> <p>LED Fortimo SLM L13 CoB</p> <p>FWHM 53.0°</p> <p>Efficiency 84 %</p> <p>Peak intensity 0.920 cd/lm</p> <p>LEDs/each optic 1</p> <p>Light colour White</p> <p>Required components: C16142_HEKLA-SOCKET-K C14658_BARBARA-RZ-LENS Bender Wirth: 432 Typ L8</p>		

PHOTOMETRIC DATA (MEASURED):

PHILIPS

LED Fortimo SLM L13 CoB
FWHM 51.0°
Efficiency 90 %
Peak intensity 1.000 cd/lm
LEDs/each optic 1
Light colour White
Required components:
C16142_HEKLA-SOCKET-K
Bender Wirth: 432 Typ L8



SAMSUNG

LED COB D Series LES 9.8 mm
FWHM 43.0°
Efficiency 94 %
Peak intensity 1.200 cd/lm
LEDs/each optic 1
Light colour White
Required components:
F15255_HEKLA-SOCKET-C

SAMSUNG

LED COB D Series LES 9.8 mm
FWHM 44.0°
Efficiency 88 %
Peak intensity 1.090 cd/lm
LEDs/each optic 1
Light colour White
Required components:
F15255_HEKLA-SOCKET-C
C14658_BARBARA-RZ-LENS

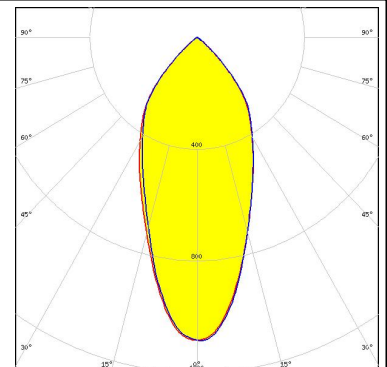
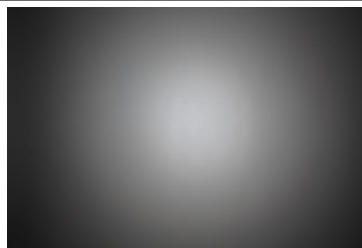

SAMSUNG

LED LC010C G2
FWHM 31.0°
Efficiency 92 %
Peak intensity 1.500 cd/lm
LEDs/each optic 1
Light colour White
Required components:
F15255_HEKLA-SOCKET-C

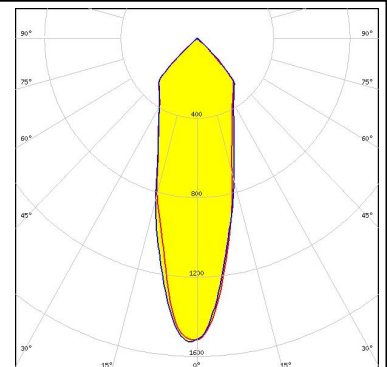
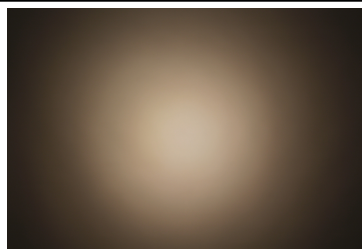

PHOTOMETRIC DATA (MEASURED):

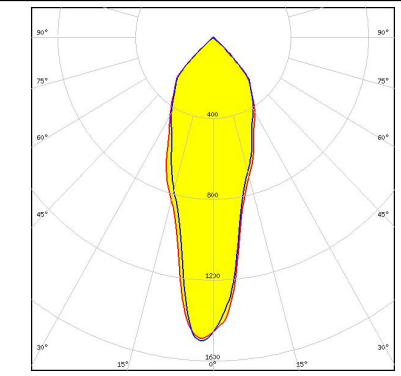
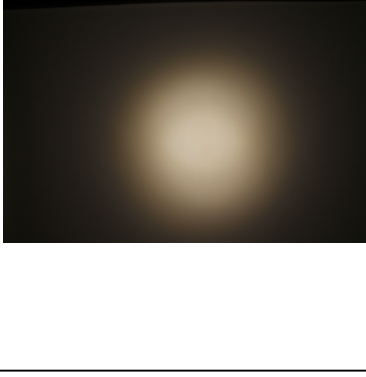
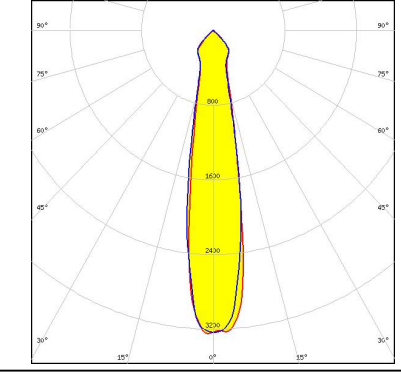
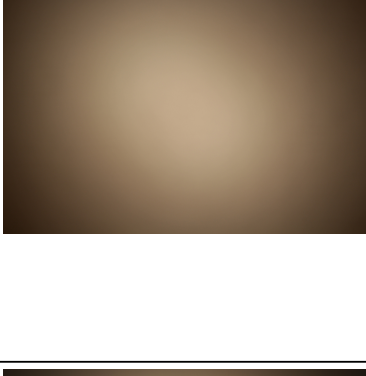
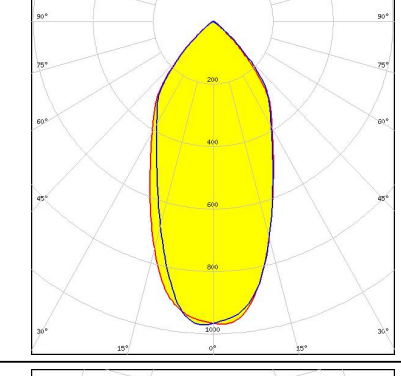
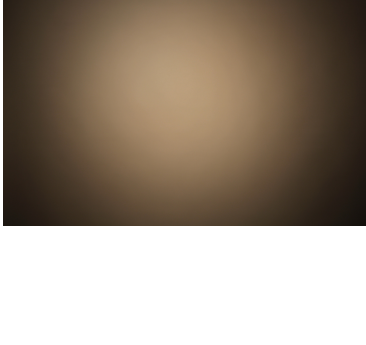
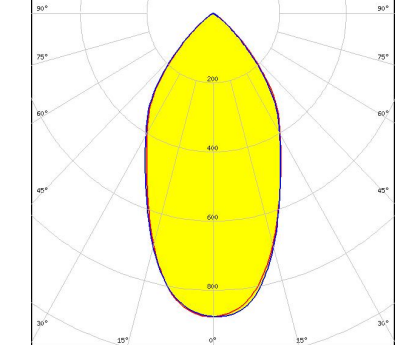
<p>SEOL SEOUL SEMICONDUCTOR</p> <p>LED MJT COB LES 6 FWHM 32.0° Efficiency 93 % Peak intensity 1.500 cd/lm LEDs/each optic 1 Light colour White Required components: F15255_HEKLA-SOCKET-C</p>		
<p>SEOL SEOUL SEMICONDUCTOR</p> <p>LED MJT COB LES 9.8 FWHM 20.0° Efficiency 92 % Peak intensity 3.300 cd/lm LEDs/each optic 1 Light colour White Required components: F15255_HEKLA-SOCKET-C</p>		
<p>TRIDONIC</p> <p>LED SLE G1 11mm 1000lm 927 Sunset R EXC FWHM 50.0° Efficiency 87 % Peak intensity 1.000 cd/lm LEDs/each optic 1 Light colour White Required components: F15859_HEKLA-SOCKET-I C14658_BARBARA-RZ-LENS</p>		
<p>TRIDONIC</p> <p>LED SLE G1 15mm 2000lm 927 Sunset R EXC FWHM 55.0° Efficiency 85 % Peak intensity 0.900 cd/lm LEDs/each optic 1 Light colour White Required components: F15859_HEKLA-SOCKET-I C14658_BARBARA-RZ-LENS</p>		

PHOTOMETRIC DATA (MEASURED):

TRIDONIC

LED SLE G7 LES09
 FWHM 41.0°
 Efficiency 91 %
 Peak intensity 1.200 cd/lm
 LEDs/each optic 1
 Light colour White
 Required components:
 F15255_HEKLA-SOCKET-C
 C14658_BARBARA-RZ-LENS

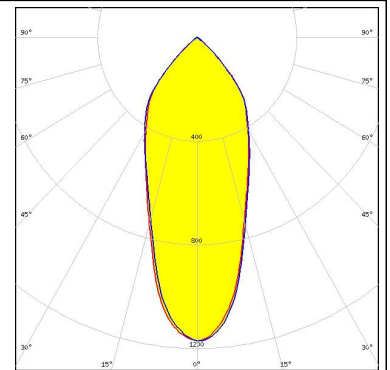

TRIDONIC

LED SLE G7 LES09
 FWHM 40.0°
 Efficiency 94 %
 Peak intensity 1.200 cd/lm
 LEDs/each optic 1
 Light colour White
 Required components:
 F15255_HEKLA-SOCKET-C

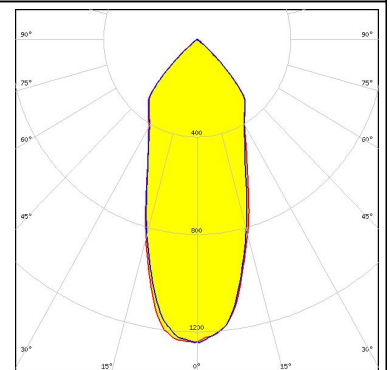
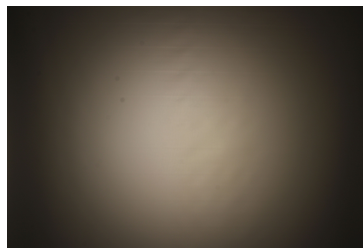

TRIDONIC

LED SLE G7 LES13
 FWHM 52.0°
 Efficiency 93 %
 Peak intensity 1.000 cd/lm
 LEDs/each optic 1
 Light colour White
 Required components:
 F15859_HEKLA-SOCKET-I

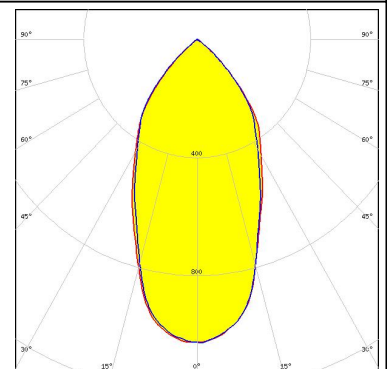
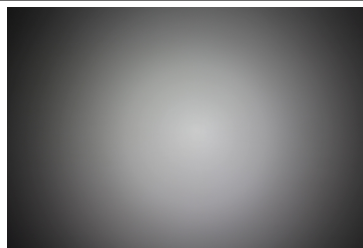

TRIDONIC

LED SLE G7 LES13
 FWHM 53.0°
 Efficiency 86 %
 Peak intensity 0.900 cd/lm
 LEDs/each optic 1
 Light colour White
 Required components:
 F15859_HEKLA-SOCKET-I
 C14658_BARBARA-RZ-LENS

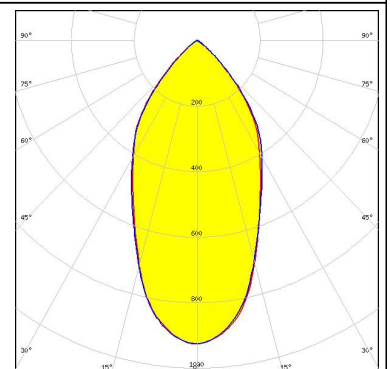
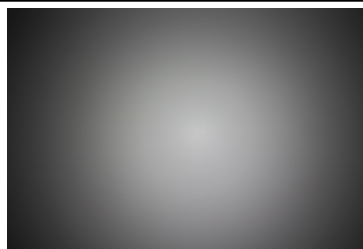

PHOTOMETRIC DATA (MEASURED):

TRIDONIC

LED SLE G7 LES15
FWHM 55.0°
Efficiency 93 %
Peak intensity 1.000 cd/lm
LEDs/each optic 1
Light colour White
Required components:
F15859_HEKLA-SOCKET-I

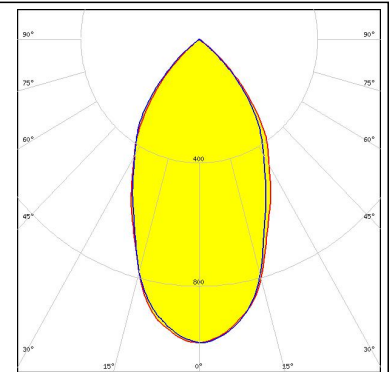
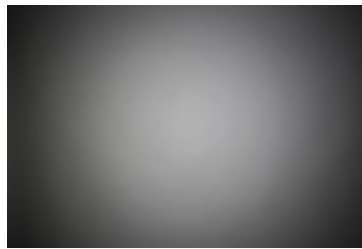

XICATO

LED XTM - 19mm LES
FWHM 62.0°
Efficiency 91 %
Peak intensity 0.870 cd/lm
LEDs/each optic 1
Light colour White
Required components:
C15743_XTM-ADAPTER-50-B

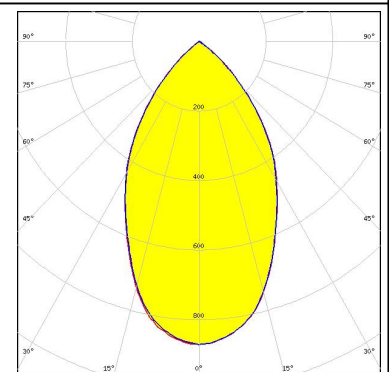

XICATO

LED XTM - 9mm LES
FWHM 41.0°
Efficiency 94 %
Peak intensity 1.200 cd/lm
LEDs/each optic 1
Light colour White
Required components:
C15743_XTM-ADAPTER-50-B

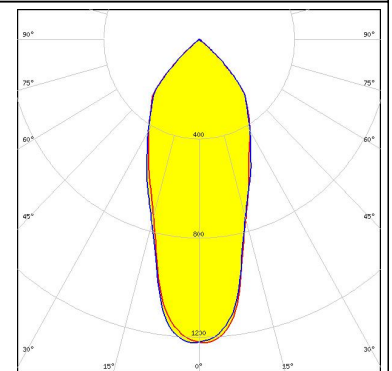
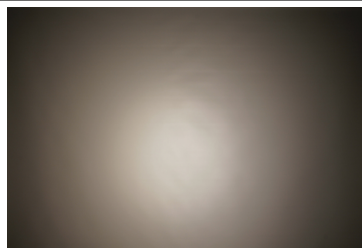

PHOTOMETRIC DATA (SIMULATED):

bridgelux.

LED V8 Gen6
FWHM 42.5°
Efficiency %
Peak intensity cd/lm
LEDs/each optic 1
Light colour White
Required components:
F15253_HEKLA-SOCKET-A

bridgelux.

LED V8 Gen6
FWHM 42.5°
Efficiency 0 %
Peak intensity 0.000 cd/lm
LEDs/each optic 1
Light colour White
Required components:
F15253_HEKLA-SOCKET-A

CITIZEN

LED CLL02x/CLU02x (LES10)
FWHM 43.0°
Efficiency 92 %
Peak intensity 1.300 cd/lm
LEDs/each optic 1
Light colour White
Required components:
F15255_HEKLA-SOCKET-C

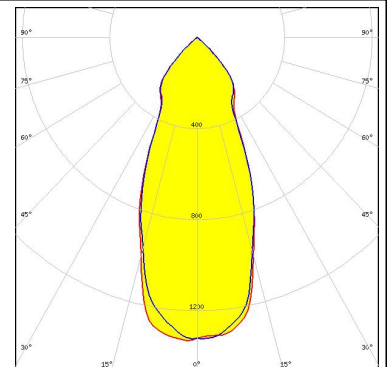

CITIZEN

LED CLL02x/CLU02x (LES10)
FWHM 45.0°
Efficiency 0 %
Peak intensity 0.000 cd/lm
LEDs/each optic 1
Light colour White
Required components:
F15255_HEKLA-SOCKET-C

PHOTOMETRIC DATA (SIMULATED):

CITIZEN

LED CLL03x/CLU03x
FWHM 47.0°
Efficiency 92 %
Peak intensity 1.220 cd/lm
LEDs/each optic 1
Light colour White
Required components:
F15859_HEKLA-SOCKET-I

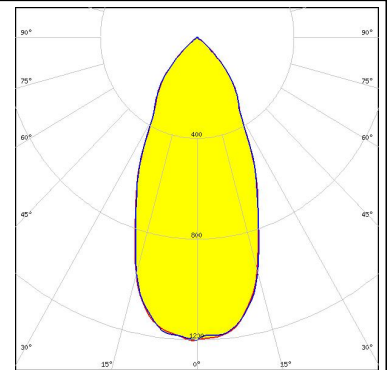

CREE

LED CXA/B 15xx
FWHM 44.0°
Efficiency %
Peak intensity cd/lm
LEDs/each optic 1
Light colour White
Required components:
F15256_HEKLA-SOCKET-D

CREE

LED CXA/B 1816 & CXA/B 1820 & CXA 1850
FWHM 46.0°
Efficiency %
Peak intensity cd/lm
LEDs/each optic 1
Light colour White
Required components:
F15254_HEKLA-SOCKET-B

CREE

LED CXA/B 1816 & CXA/B 1820 & CXA 1850
FWHM 46.0°
Efficiency 0 %
Peak intensity 0.000 cd/lm
LEDs/each optic 1
Light colour White
Required components:
F15254_HEKLA-SOCKET-B

PHOTOMETRIC DATA (SIMULATED):



LED COB T-Type
FWHM 42.0°
Efficiency 90 %
Peak intensity 1.420 cd/lm
LEDs/each optic 1
Light colour White
Required components:
F15848_HEKLA-SOCKET-G

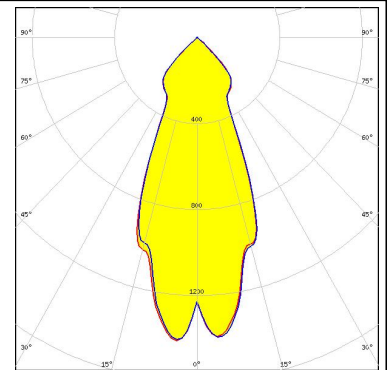

LED Soleriq S13 Gen2
FWHM 43.8°
Efficiency 93 %
Peak intensity 1.340 cd/lm
LEDs/each optic 1
Light colour White
Required components:
F15859_HEKLA-SOCKET-I

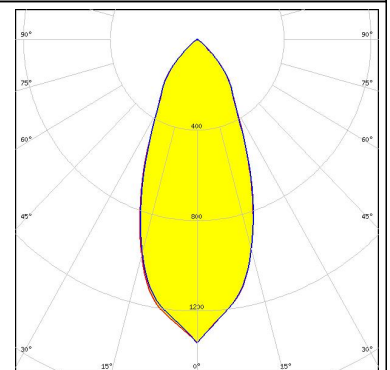

LED Soleriq S9
FWHM 44.3°
Efficiency 93 %
Peak intensity 1.300 cd/lm
LEDs/each optic 1
Light colour White
Required components:
F15255_HEKLA-SOCKET-C

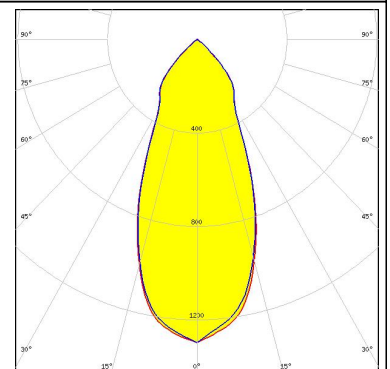

LED COB D Series LES 14.5 mm
FWHM 49.5°
Efficiency 88 %
Peak intensity 1.070 cd/lm
LEDs/each optic 1
Light colour White
Required components:
F15859_HEKLA-SOCKET-I

PHOTOMETRIC DATA (SIMULATED):

TRIDONIC

LED SLE G6 LES10
FWHM 49.0°
Efficiency 94 %
Peak intensity 1.100 cd/lm
LEDs/each optic 1
Light colour White
Required components:
F15255_HEKLA-SOCKET-C

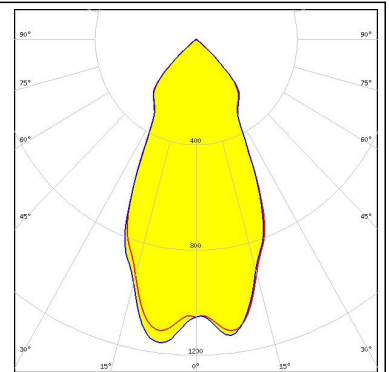

TRIDONIC

LED SLE G6 LES15
FWHM 48.0°
Efficiency 92 %
Peak intensity 1.200 cd/lm
LEDs/each optic 1
Light colour White
Required components:
F15859_HEKLA-SOCKET-I

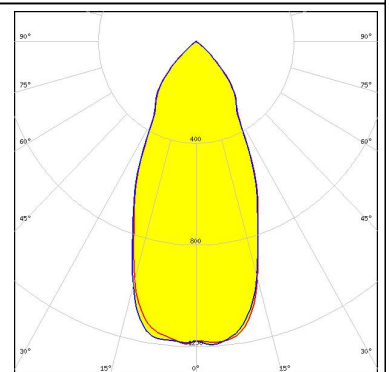

TRIDONIC

LED SLE G6 LES17
FWHM 49.0°
Efficiency 92 %
Peak intensity 1.160 cd/lm
LEDs/each optic 1
Light colour White
Required components:
F15859_HEKLA-SOCKET-I

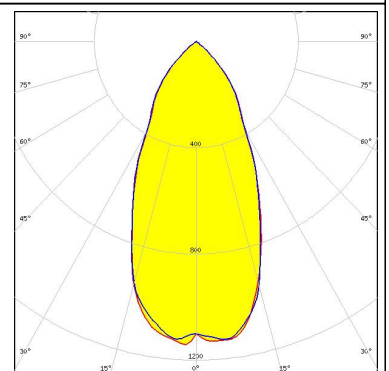

XICATO

LED XTM - 9mm LES
FWHM 48.0°
Efficiency 93 %
Peak intensity 1.220 cd/lm
LEDs/each optic 1
Light colour White
Required components:
C15743_XTM-ADAPTER-50-B

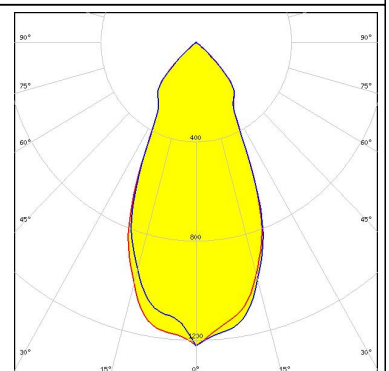

GENERAL INFORMATION:

NOTE: The typical beam angle will be changed by different color, chip size and chip position tolerance. The typical total beam angle is the full angle measured where the luminous intensity is half of the peak value.

Due to use of high power COB's with this product, special attention to proper thermal design is highly recommended. LEDiL has no liability for direct, indirect or consecutive damages arising from the LEDiL products being used outside of the recommended temperature range.

MATERIALS:

As part of our continuous research and improvement processes, and to ensure the best possible quality and availability of our products, LEDiL reserves the right to change material grades without notice.

PRODUCT DATA USER AGREEMENT AND DISCLAIMER:

The measured data in the provided downloadable LEDiL Product Datasheets and Mechanical 2D-Drawings is rounded and provided as reference for planning. LEDiL Oy's optical specifications have been verified by conducting performance testing of the products in accordance with the company's quality system. The reported data are averaged results of multiple measurements with typical variation. LEDiL Oy reserves the right to without prior notification make changes and improvements to its products.

LEDiL Oy assumes neither warranty, nor guarantee nor any other liability of any kind for the contents and correctness of the provided data. The provided data has been generated with highest diligence but the provided data may in reality not represent the complete possible variation range of all intrinsic parameters. Therefore, in certain cases a deviation from the provided data could occur.

LEDiL Oy reserves the right to undertake technical changes of its products without further notification which could lead to changes in the provided data. LEDiL Oy assumes no liability of any kind for the possible deviation from any provided data or any other damage resulting from the usage of the provided data.

The user agrees to this disclaimer and user agreement with the download or usage of the provided files.

LEDiL Oy

Joensuunkatu 13
FI-24240 SALO
Finland

LEDiL Inc.

228 West Page Street
Suite D
Sycamore IL 60178
USA

Local sales and technical support

www.ledil.com/where_to_buy

Shipping locations

Salo, Finland
Hong Kong, China

Distribution Partners

www.ledil.com/where_to_buy