

CCT Tunable LED Series Chip on Board

COB T-Series Tunable COB

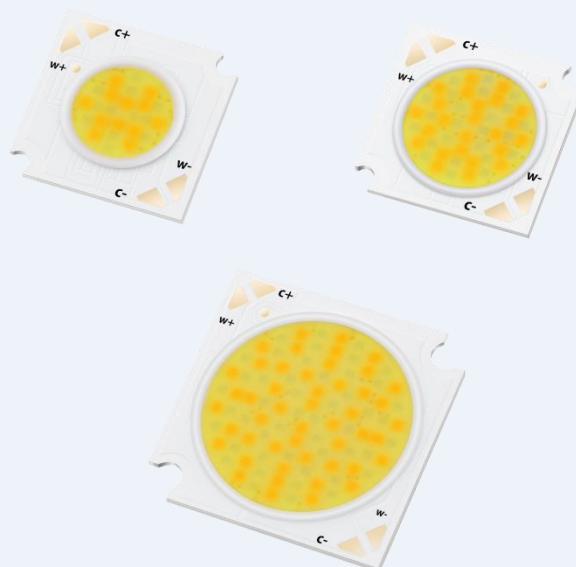

High efficacy COB LED package
Well-suited for use in spotlight applications

Features & Benefits

- Chip on Board (COB) solution makes it easy to design in
- Simple assembly reduces manufacturing cost
- Low thermal resistance
- InGaN/GaN MQW LED with long time reliability

Applications

- Spotlight / Downlight
- LED Retrofit Bulbs
- Outdoor Illumination



Table of Contents

1.	Characteristics	-----	3
2.	Product Code Information	-----	5
3.	Typical Characteristics Graphs	-----	8
4.	Outline Drawing & Dimension	-----	12
5.	Product Information Marking	-----	15
6.	Reliability Test Items & Conditions	-----	17
7.	Certification & Declaration	-----	18
8.	Label Structure	-----	19
9.	Packing Structure	-----	20
10.	Precautions in Handling & Use	-----	22

1. Characteristics

a) Absolute Maximum Rating

Item	Symbol	Model	Rating	Unit	Condition
Ambient / Operating Temperature	T_a	All model	-40 ~ +85	°C	-
Storage Temperature	T_{stg}	All model	-40 ~ +105	°C	-
LED Junction Temperature	T_j	All model	130	°C	-
Case Temperature	T_c	All model	105	°C	-
Forward Current	I_f	LC010T	400	mA	-
		LC020T	800		
		LC035T	1250		
Power Dissipation	P_D	LC010T	15	W	-
		LC020T	30		
		LC035T	45		

b) Electro-optical Characteristics (I_f = Sorting Current, $T_j = 25^\circ\text{C}$)

Item	Unit	Model	Rank	Min.	Typ.	Max.
Forward Voltage (V_f)	[V]	All model	-	32.0	35.5	38.0
Color Rendering Index (R_a)	-	All model	5	80	-	-
			7	90	-	-
Beam Angle	°		-	-	115	-
Nominal Power / Sorting Current	W / mA	LC010T	-	-	10 / 280	-
		LC020T	-	-	20 / 560	-
		LC035T	-	-	35 / 980	-
Thermal Resistance (Junction to T_c measurement point)	°C / W	LC010T	-	-	3.32	-
		LC020T	-	-	1.73	-
		LC035T	-	-	0.95	-

Notes:

- 1) The COB is tested in pulsed condition at rated test current (10 ms pulse width) and rated temperature ($T_j = T_c = 25^\circ\text{C}$)
Thermal Resistance is measured under conditions of $T_c = 85^\circ\text{C}$
- 2) Samsung maintains measurement tolerance of: forward voltage = $\pm 5\%$, CRI = ± 3
- 3) Refer to the derating curve, '3. Typical Characteristics Graph' designed within the range
- 4) Minimum operating current (I_{f_min}): LC010T = 2mA, LC020T = 4mA, LC035T = 8mA.

c) Luminous Flux Characteristics ($I_F = \text{Sorting Current}$)

Model	CRI (Ra) Min.	Nominal CCT (K)	Channel	Flux @ $T_J = 25\text{ }^\circ\text{C}$ (lm)		
				Min.	Typ.	Max.
LC010T	80	2700	W	1131	1190	-
		6500	C	1285	1352	-
	90	2700	W	939	988	-
		5000	C	1092	1149	-
LC020T	80	2700	W	2237	2355	-
		6500	C	2543	2676	-
	90	2700	W	1858	1956	-
		5000	C	2161	2275	-
LC035T	80	2700	W	4185	4405	-
		6500	C	4756	5006	-
	90	2700	W	3477	3660	-
		5000	C	4042	4255	-

Notes:

- 1) The COB is tested in pulsed operating condition at rated test current (10 ms pulse width) and rated temperature ($T_J = T_C = 25\text{ }^\circ\text{C}$).
- 2) Samsung maintains measurement tolerance of: Luminous flux = $\pm 7\%$, CRI = ± 3

2. Product Code Information

1	2	3	4	5	6	7	8	9	10	11	12	13	14	15	16	17	18
S	P	H	W	H	A	H	D	N	H	2	5	Y	Z	W	P	T	1

Digit	PKG Information	Code	Specification
1 2 3	Type	SPH	Samsung Package High Power
4 5	Color	WH	White
6	Product Version	A	Tunable COB
7 8	Form Factor	HD	COB
9	Lens Type	N	No lens
10	Wattage or Model	C F H	LC010T LC020T LC035T
11	Internal Code	2	General
12	CRI	5	Min 80
		7	Min 90
13	Forward Voltage (V)	Y	32.0 ~ 38.0
14	SDCM (WW/CW)	Z	WW Mac 3 / CW Mac 5
		3	WW Mac 3 / CW Mac 3
15	CCT (K), Channel W	W	2700 K
16	CCT (K), Channel C	P	6500 K
		R	5000 K
17 18	Luminous Flux	T1	Tunable COB Gen.1 level

a) Binning Structure (If = Sorting Current, T_j = 25°C)

CRI (R _a) Min.	Model	Product Code	V _F Rank	Color Rank	Flux Rank	Flux Range (Φ _v , Im)	
80	LC010T	SPHWAHDNC25Y☆WPT1	Y	WP	T1	WW	1131~
						CW	1285~
	LC020T	SPHWAHDNF25Y☆WPT1	Y	WP	T1	WW	2237~
						CW	2543~
	LC035T	SPHWAHDNH25Y☆WPT1	Y	WP	T1	WW	4185~
						CW	4756~
90	LC010T	SPHWAHDNC27Y☆WRT1	Y	WR	T1	WW	939~
						CW	1092~
	LC020T	SPHWAHDNF27Y☆WRT1	Y	WR	T1	WW	1858~
						CW	2161~
	LC035T	SPHWAHDNH27Y☆WRT1	Y	WR	T1	WW	3477~
						CW	4042~

Notes:

"☆" can be "Z" (WW Mac3/CW Mac5) or "3" (WW Mac3/CW Mac3).

b) Chromaticity Region & Coordinates (If = Sorting Current, $T_j = 25^\circ\text{C}$)

① Ra min 80 model

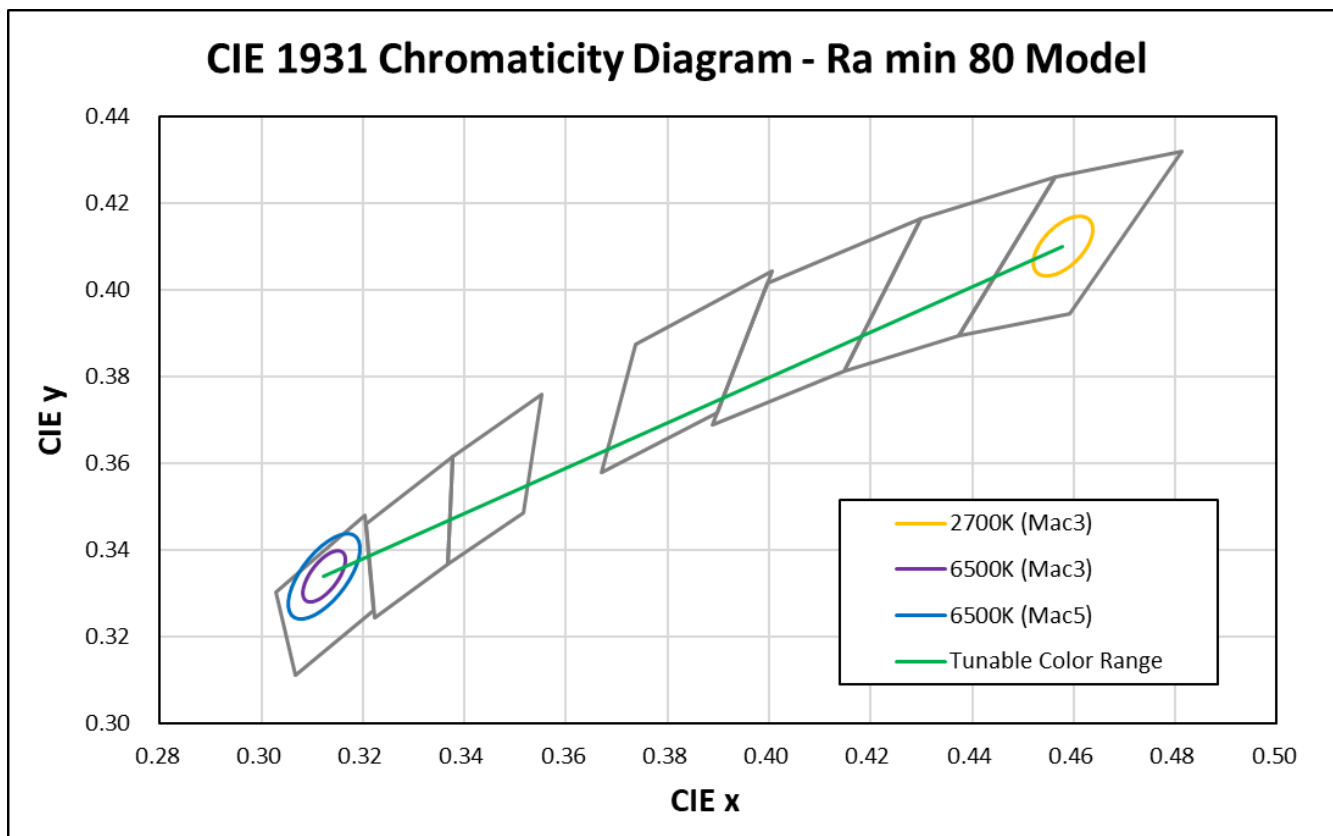

2700K (Mac3)				
x	y	Θ	a	b
0.4578	0.4101	53.70	0.0081	0.0042

6500K (Mac3)				
x	y	Θ	a	b
0.3123	0.3341	58.57	0.0067	0.0029

6500K (Mac5)				
x	y	Θ	a	b
0.3123	0.3341	58.57	0.0112	0.0048

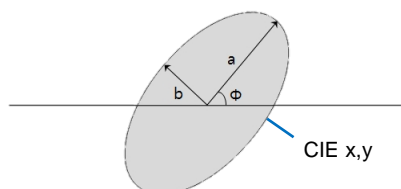
**Note:**

Samsung maintains measurement tolerance of: $C_x, C_y = \pm 0.005$

② Ra min 90 model

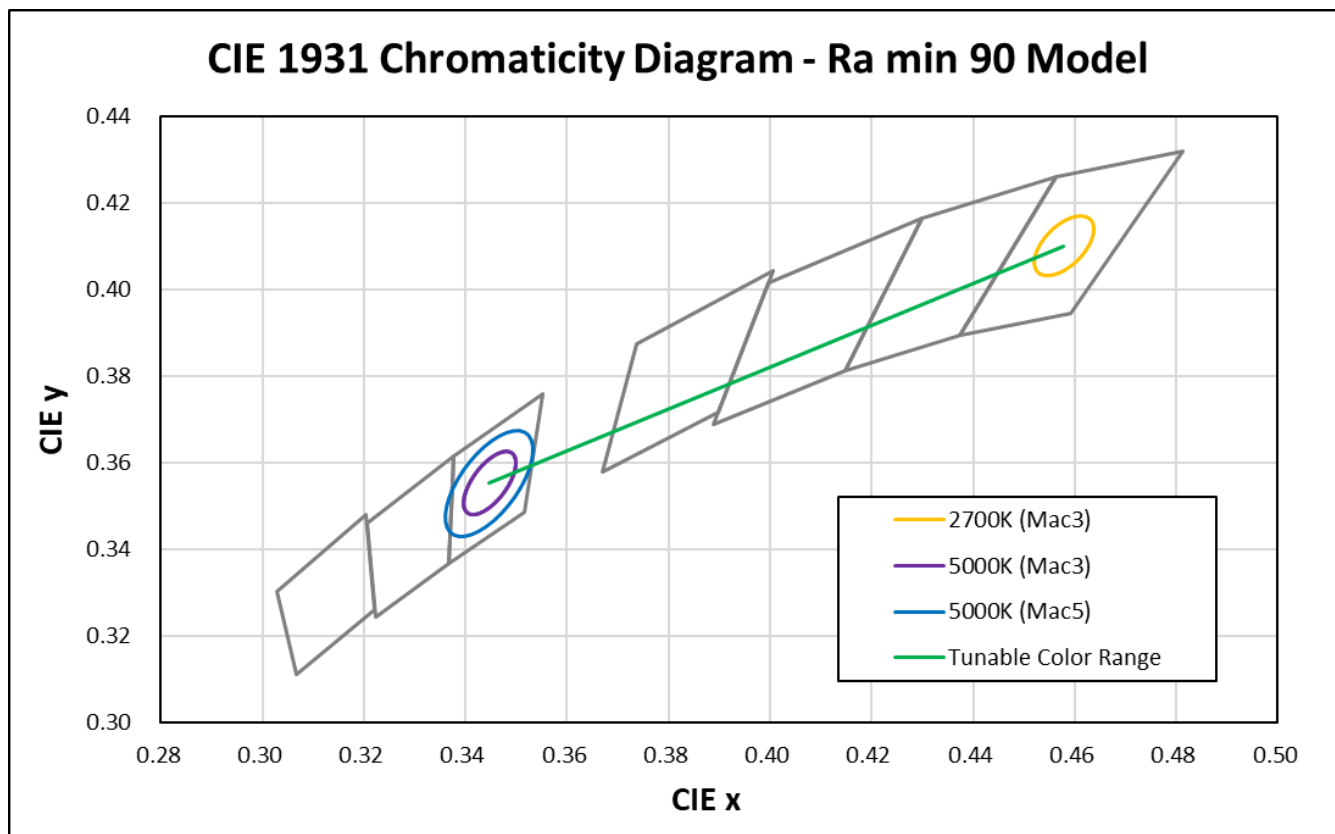

2700K (Mac3)				
x	y	θ	a	b
0.4578	0.4101	53.70	0.0081	0.0042

5000K (Mac3)				
x	y	θ	a	b
0.3447	0.3553	59.62	0.0082	0.0035

5000K (Mac5)				
x	y	θ	a	b
0.3447	0.3553	59.62	0.0137	0.0059

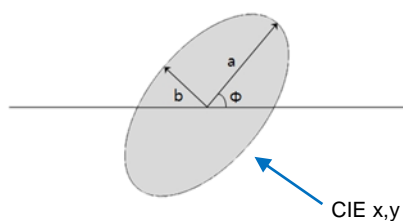
**Note:**

Samsung maintains measurement tolerance of: $C_x, C_y = \pm 0.005$

3. Typical Characteristics Graphs

a) Spectrum Distribution ($I_f = \text{Sorting Current}$, $T_j = 25^\circ\text{C}$)

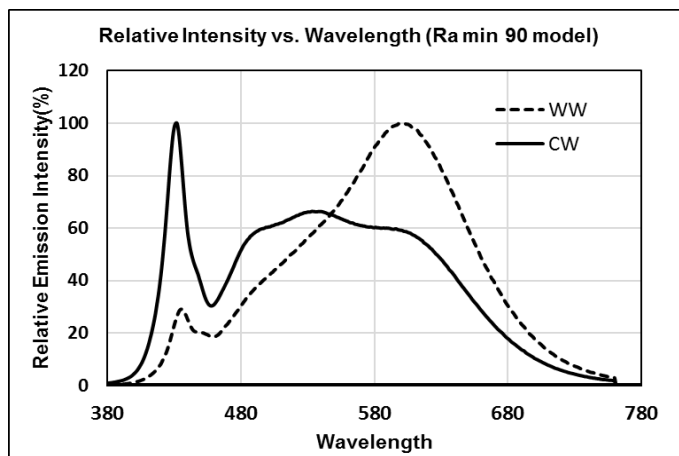
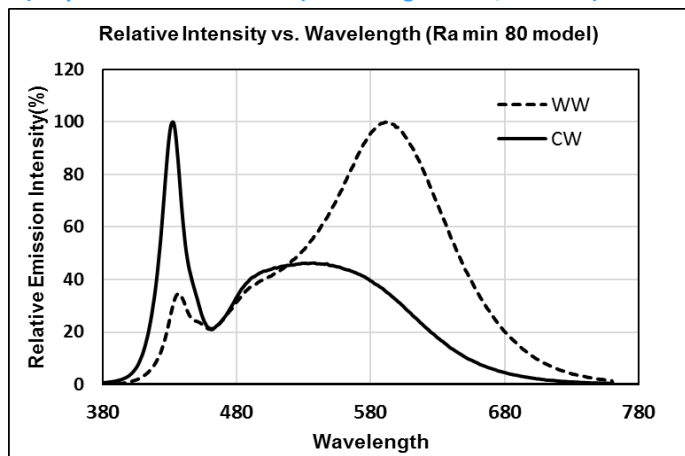

b) Forward Current Characteristics ($T_j = 25^\circ\text{C}$)

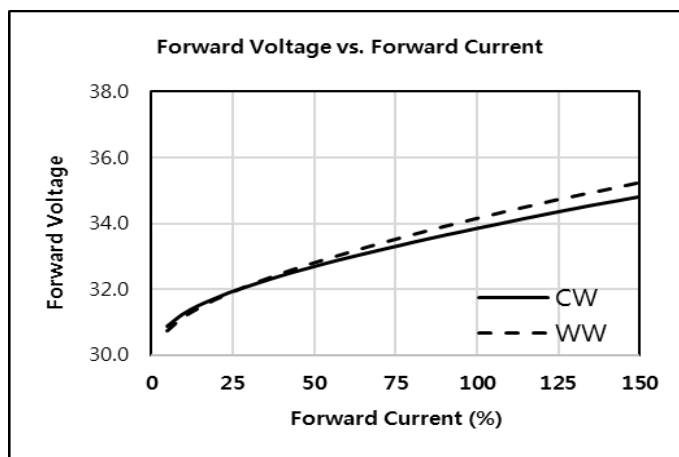
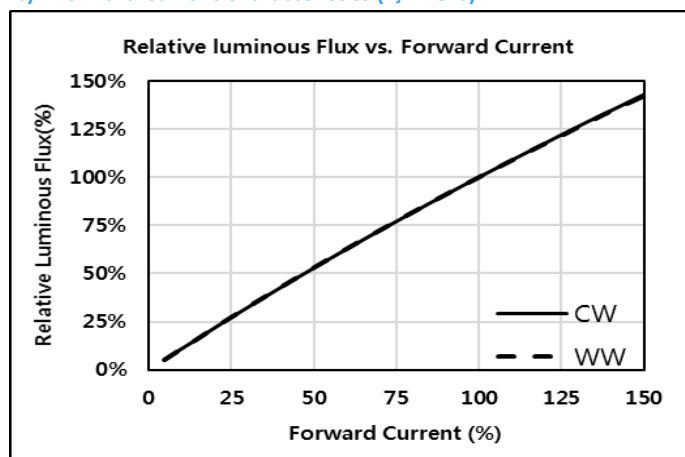

c) Temperature Characteristics ($I_f = \text{Sorting Current}$)

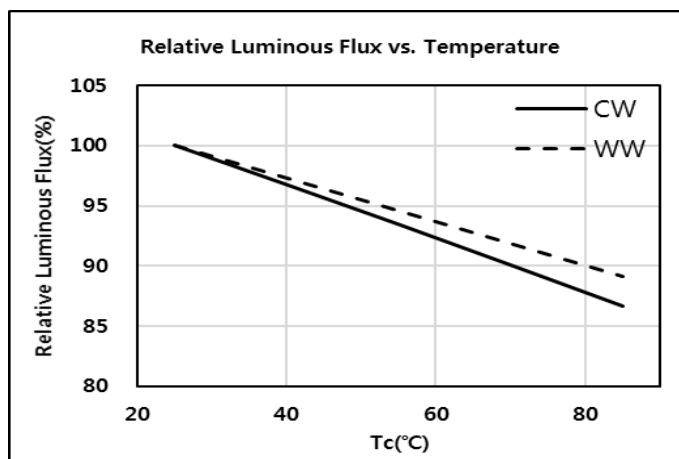
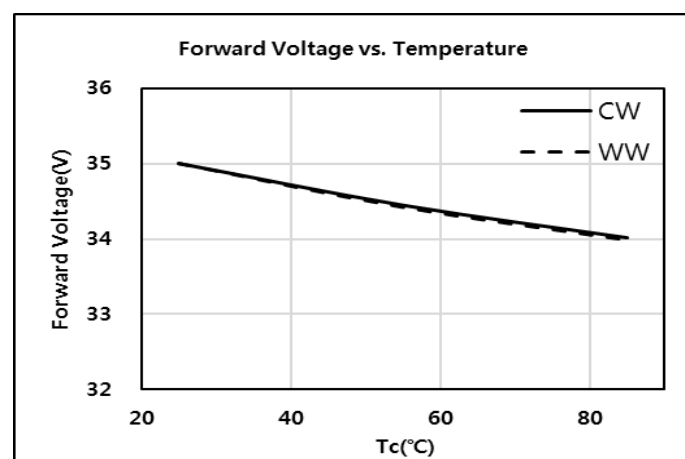

d) Color Shift Characteristics ($T_j = 25^\circ\text{C}$, $I_f = \text{Sorting Current}$)

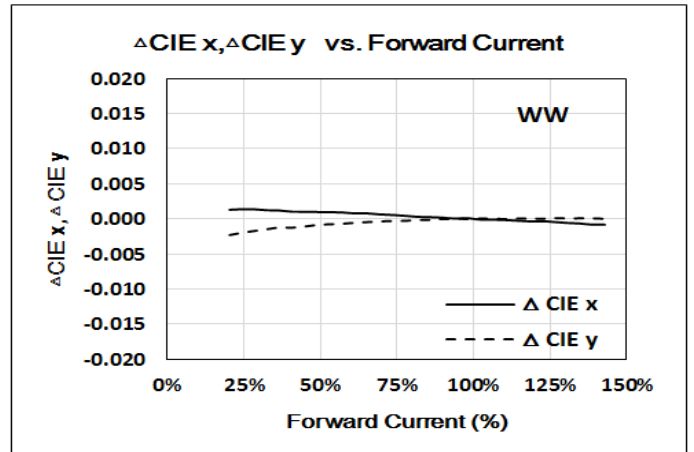
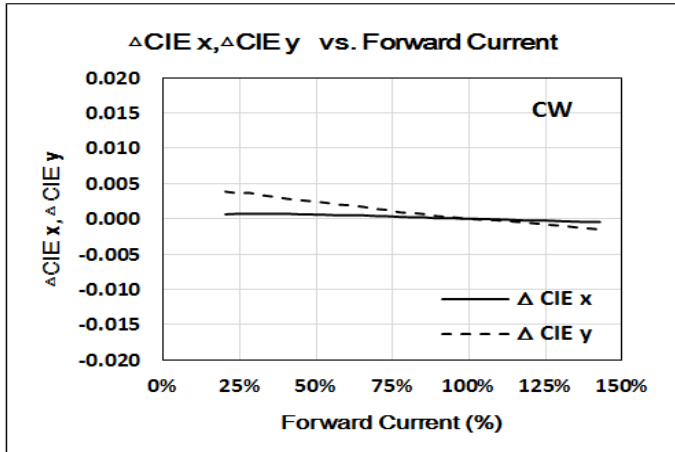

e) CCT, Color shift vs. Current ratio

CCT (K)	Ra 80 Model				Ra 90 Model			
	If_CW	If_WW	CIE x	CIE y	If_CW	If_WW	CIE x	CIE y
6500	100%	0%	0.3131	0.3326				
5700	87%	13%	0.3281	0.3401				
5000	71%	29%	0.3459	0.3501	100%	0%	0.3447	0.3553
4500	60%	40%	0.3594	0.3573	83%	17%	0.3606	0.3630
4000	46%	54%	0.3782	0.3673	64%	36%	0.3791	0.3720
3500	31%	69%	0.4008	0.3795	41%	59%	0.4025	0.3834
3000	12%	88%	0.4347	0.3977	15%	85%	0.4344	0.3989
2700	0%	100%	0.4613	0.4119	0%	100%	0.4578	0.4102

f) Beam Angle Characteristics ($I_f = \text{Sorting Current}$, $T_j = 25^\circ\text{C}$)

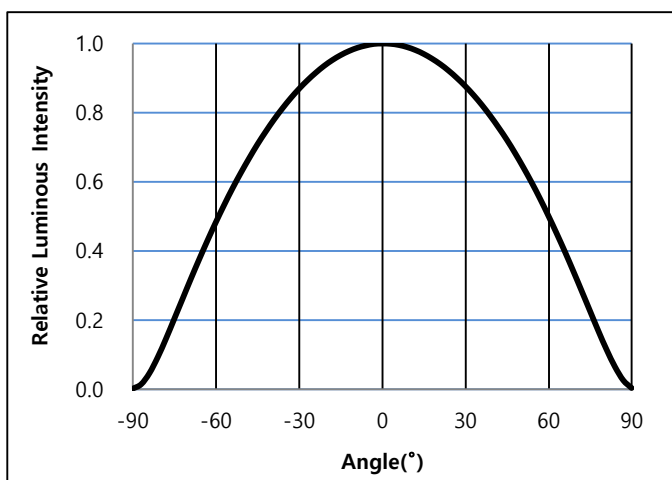

g) Derating Curve

1) LC010T

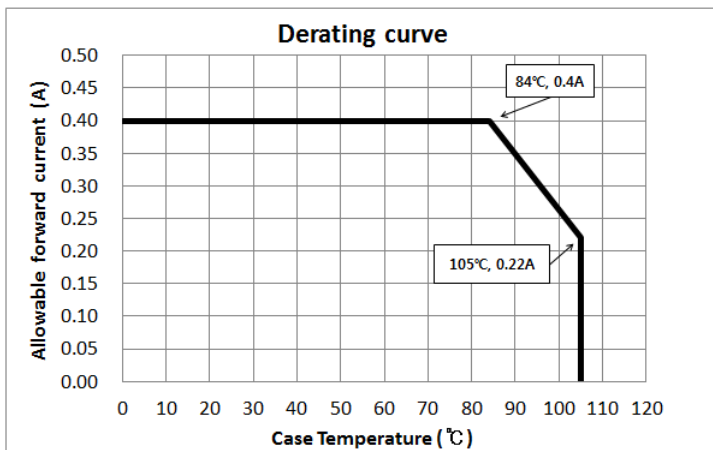

2) LC020T

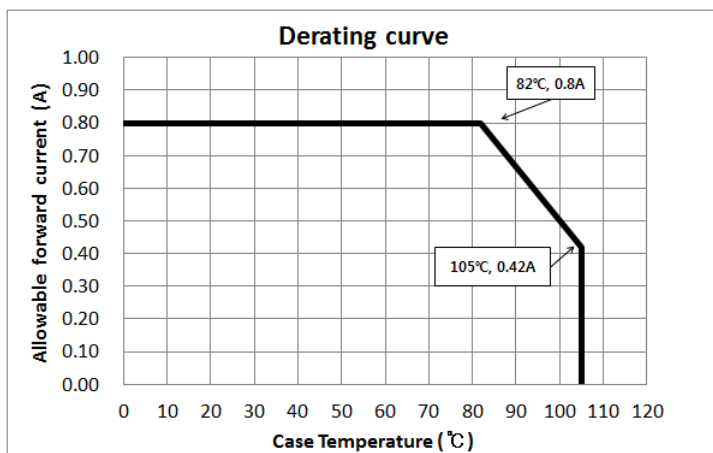

3) LC035T

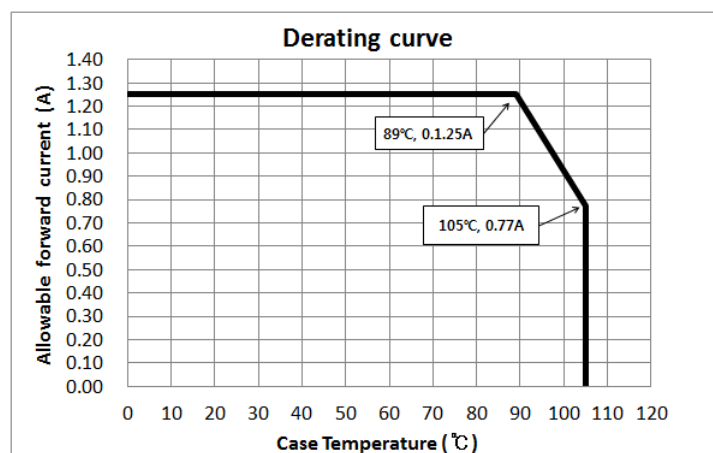

4. Outline Drawing & Dimension

a) LC010T

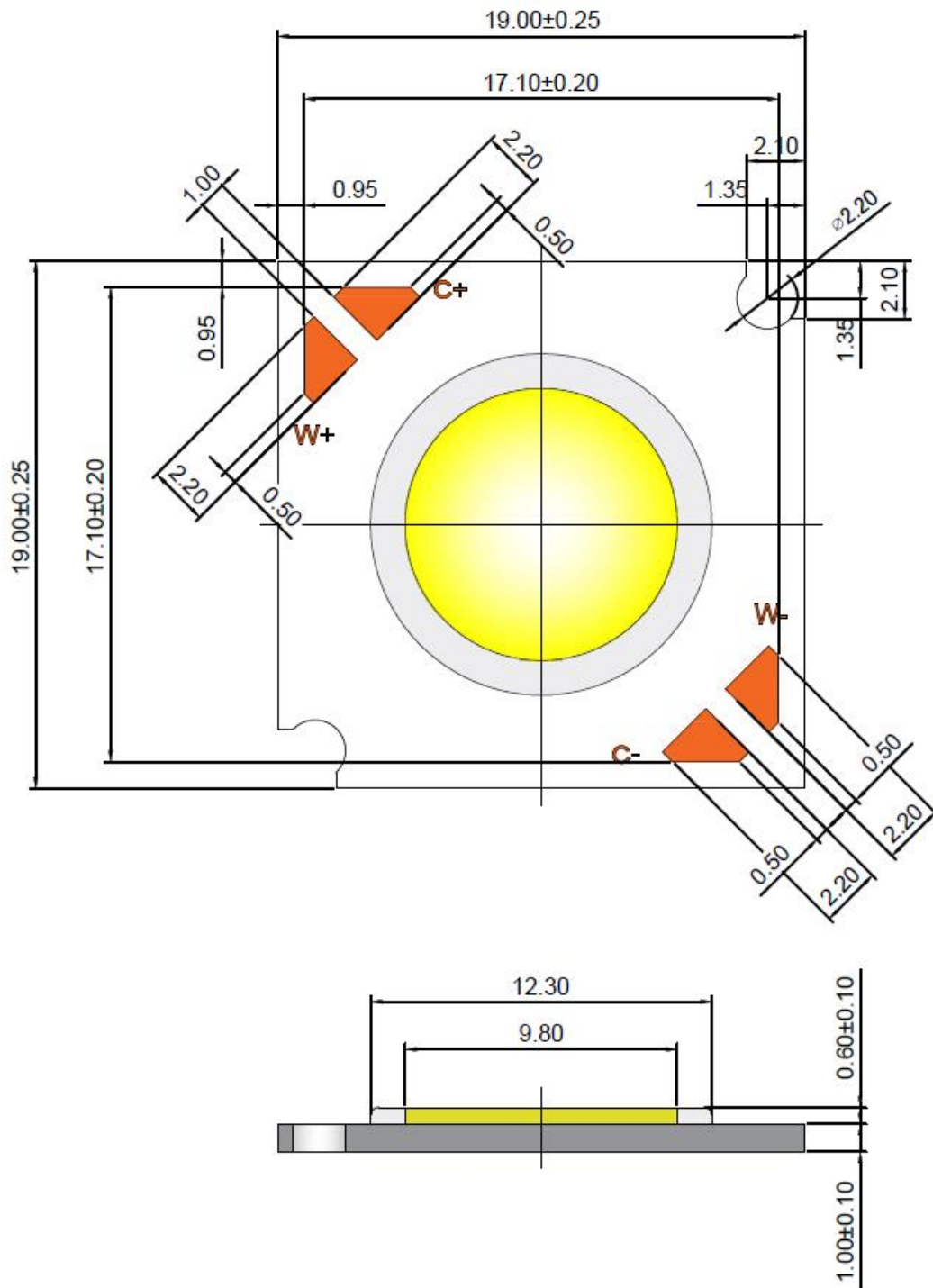

Unit: mm
Tolerance (Lateral): ± 0.25 mm
Tolerance (Height): ± 0.10 mm

b) LC020T

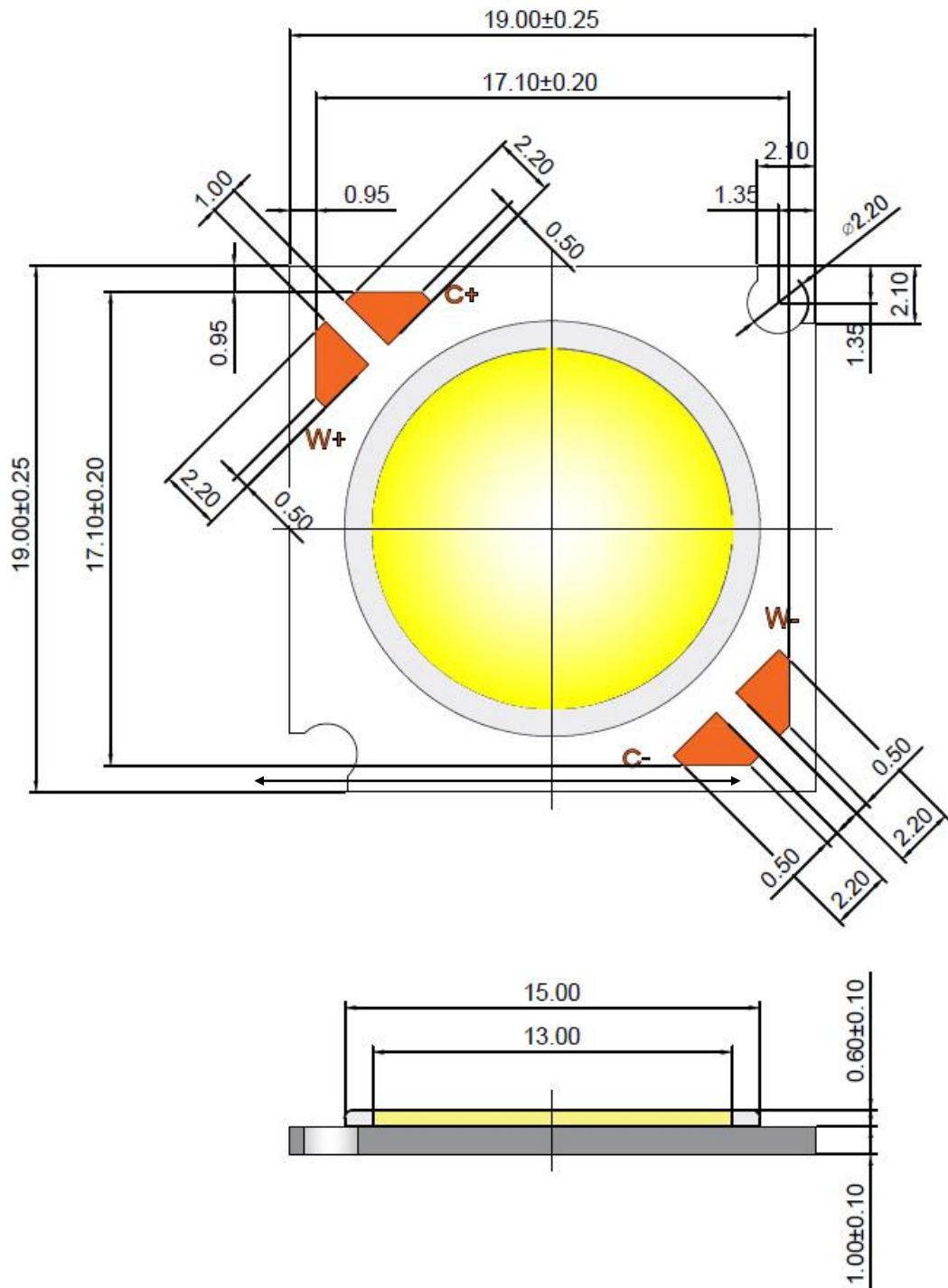

Unit: mm
 Tolerance (Lateral): ± 0.25 mm
 Tolerance (Height): ± 0.10 mm

c) LC035T

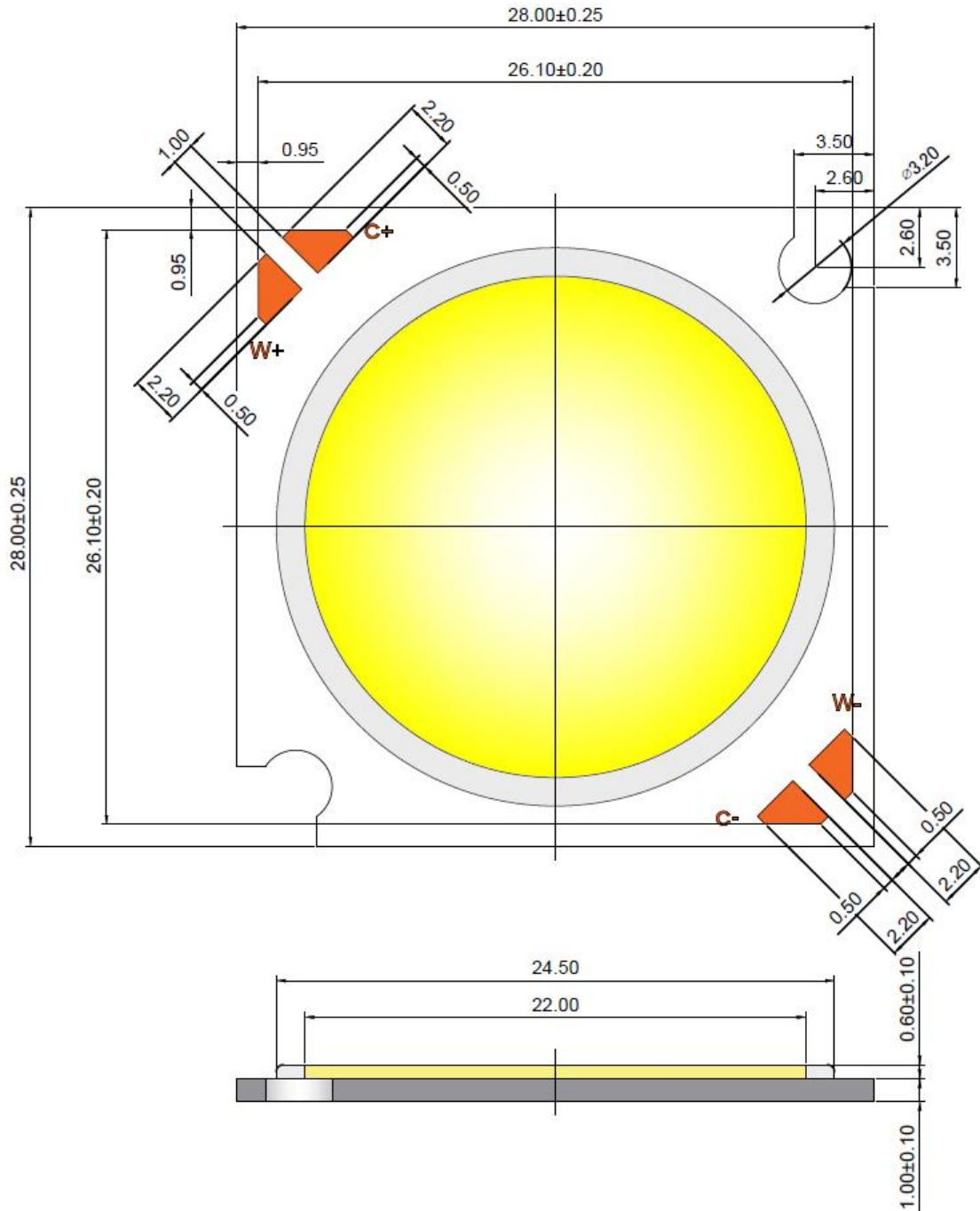

Unit: mm
 Tolerance (Lateral): ± 0.25 mm
 Tolerance (Height): ± 0.10 mm

5. Product Information Marking

5.1 Marking Position

a) LC010T

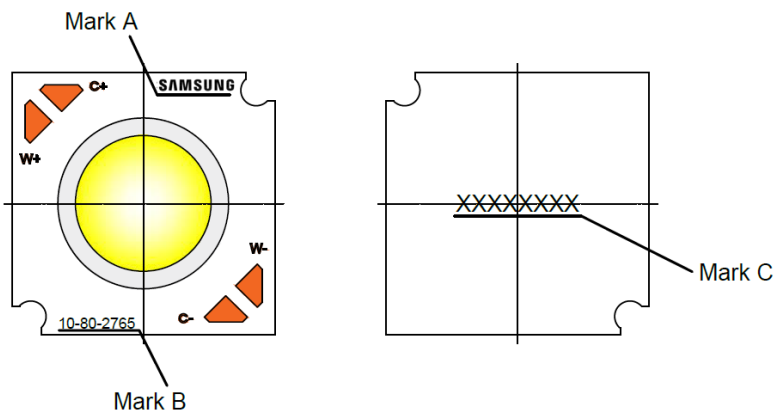

b) LC020T

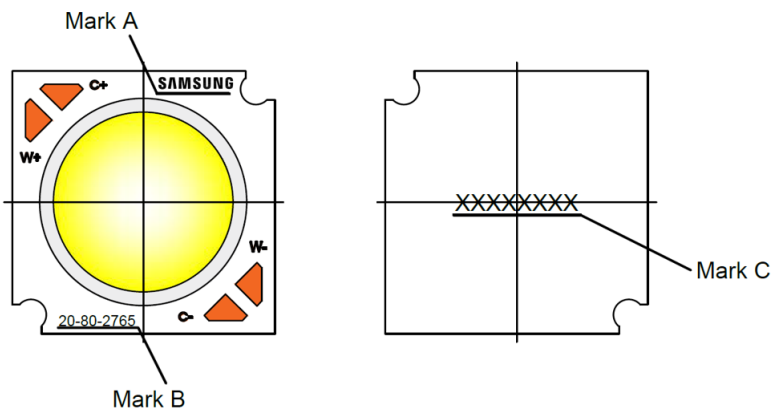

c) LC035T

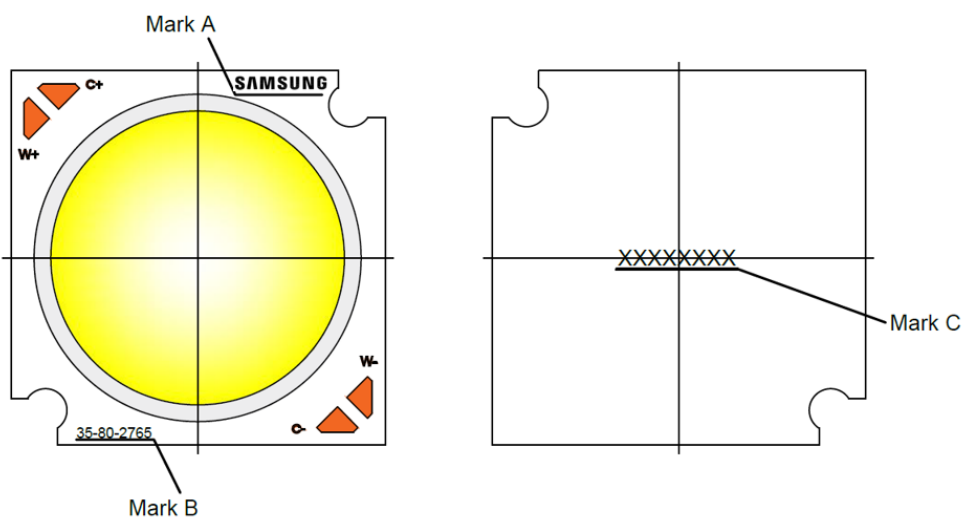

5.2 Marking Contents

Marking Position	Item	Content
Mark A	SAMSUNG LOGO	SAMSUNG Marking
Mark B	Power/Ra/CCT range	Please refer to below
Mark C	Lot number	

Samsung COB P/N	Samsung model code	Mark B
LC010T CRI80	SPHWHAH DNC25Y☆WPT1	10-80-2765
LC020T CRI80	SPHWHAH DNF25Y☆WPT1	20-80-2765
LC035T CRI80	SPHWHAH DNH25Y☆WPT1	35-80-2765
LC010T CRI90	SPHWHAH DNC27Y☆WRT1	10-90-2750
LC020T CRI90	SPHWHAH DNF27Y☆WRT1	20-90-2750
LC035T CRI90	SPHWHAH DNH27Y☆WRT1	35-90-2750

Notes :

"☆" can be "Z" (WW Mac3/CW Mac5) or "3" (WW Mac3/CW Mac3).

6. Reliability Test Items & Conditions

a) Test Items

Test Item	Test Condition	Test Hour / Cycle
High Temperature Operating Life Test	85°C, DC Derating, I_F	1000 h
Wet High Temperature Operating Life Test	60°C, 90 % RH, DC Derating, I_F	1000 h
Low Temperature Operating Life Test	-40°C, DC Derating I_F	1000 h
High Temperature Storage	120°C	1000 h
Low Temperature Storage	-40°C	1000 h
Wet High Temperature Storage	60°C, 90% RH	1000h
Powered Temperature Cycle	-40°C/ 85°C each 10 min, 20 min transfer power on/off each 5 min, DC Derating, I_F	100 cycles
Temperature Cycling	-45°C / 15min ~ 125°C / 15min Temperature change within 5min	500 cycles
ESD (HBM)	R ₁ : 10 MΩ R ₂ : 1.5 kΩ C: 100 pF V: ±2 kV	5 times
Vibration Test	20~ 80 Hz (displacement: 0.06 inch, max. 20 g) 80 ~ 2 kHz (max. 20 g) min. frequency ↔ max. frequency 4 min transfer	4 times
Mechanical Shock Test	1500g, 0.5 ms each of the 6 surfaces (3 axis x 2 sides)	5 times

b) Criteria for Judging the Damage

Item	Symbol	Test Condition ($T_c = 25^\circ\text{C}$)	Limit	
			Min.	Max.
Forward Voltage	V_F	$I_F = \text{Sorting Current}$	L.S.L. * 0.9	U.S.L. * 1.1
Luminous Flux	Φ_v	$I_F = \text{Sorting Current}$	L.S.L * 0.7	U.S.L * 1.3

7. Certification & Declaration

Item	Complaint to	Remark
	UL	E347623
Test & Certification Declaration	Photo-biological Safety	Risk group(at I _{max}) RG2 (LC010T) Ethr = 582.030 lx, RG1 at d ≥ 1.0 m (LC020T) Ethr = 689.304 lx, RG1 at d ≥ 1.3 m (LC035T) Ethr = 628.924 lx, RG1 at d ≥ 1.8 m
	Type Classification	Integral LED Module

8. Label Structure

a) Label Structure

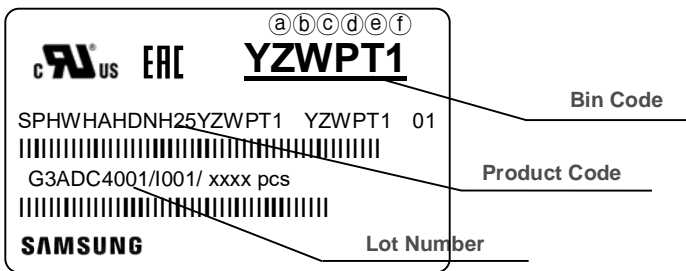

Note: Denoted bincode and product code above is only an example (see description on page 5)

Bin Code:

- ⒶⒷ: Forward Voltage bin (refer to page 3)
- ⒸⒹ: Chromaticity bin (refer to page 7)
- ⒺⒻ: Luminous Flux bin (refer to page 4)

b) Lot Number

The lot number is composed of the following characters:

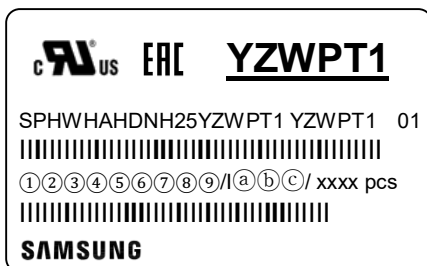

① ③④⑤⑥⑦⑧⑨ / ⒶⒷⒸ / xxxx pcs

- ① : Production site (G: Shenzhen, China)
- ② : 3(LED)
- ③ : Product state (A: Normal, B: Bulk, C: First Production, R: Reproduction, S: Sample)
- ④ : Year (D: 2019, E: 2020, F:2021...)
- ⑤ : Month (1~9, A, B, C)
- ⑥⑦⑧⑨ : Day (1~9, A, B~V)
- ⒶⒷⒸ : Product serial number (001 ~ 999)

9. Packing Structure

9.1 LC010T, LC020T

Packing material	Max. Quantity in pcs of COB	Dimension(mm)			
		Length	Width	Height	Tolerance
Tray	25	198	183	9	2
AL Bag	125 (5 trays)	300	240	-	1
Outer Box (Small)	750 (6 bags)	248	225	187	5

a) Packing Structure

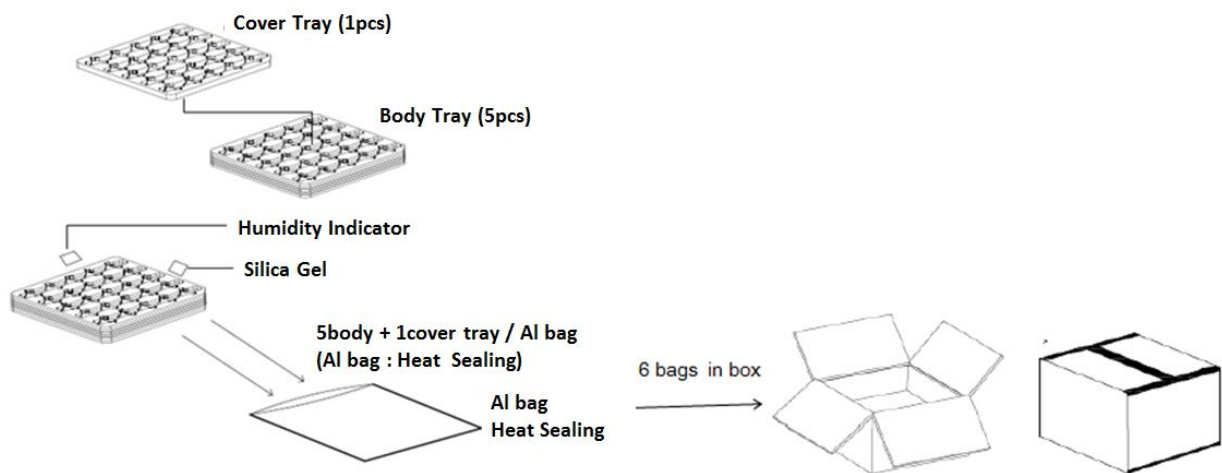

b) Tray

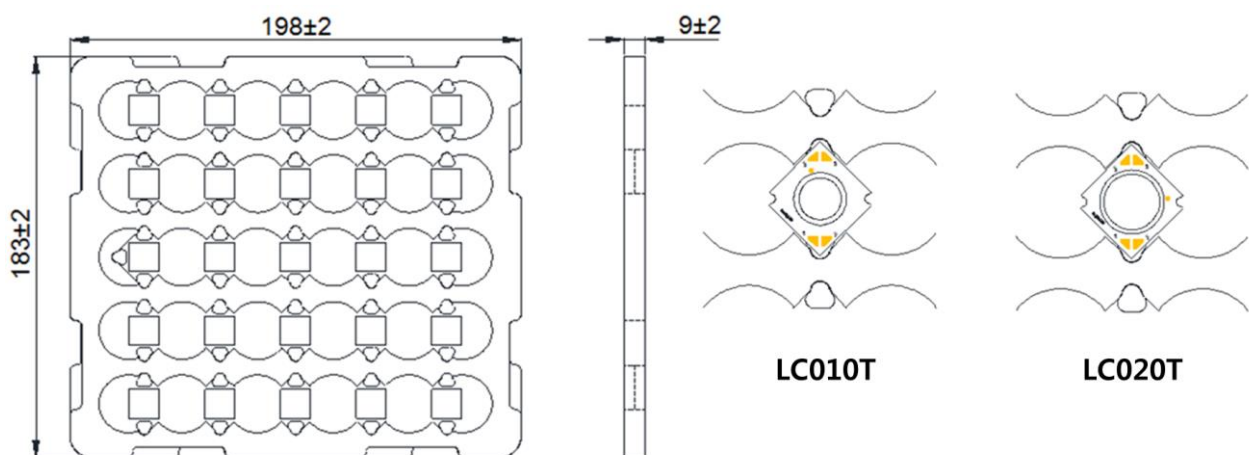

9.2 LC035T

Packing material	Max. Quantity	Dimension(mm)			
	in pcs of COB	Length	Width	Height	Tolerance
Tray	20	198	183	9	2
AL Bag	100 (5 trays)	300	240	-	1
Outer Box (Small)	600 (6 bags)	248	225	187	5

a) Packing Structure

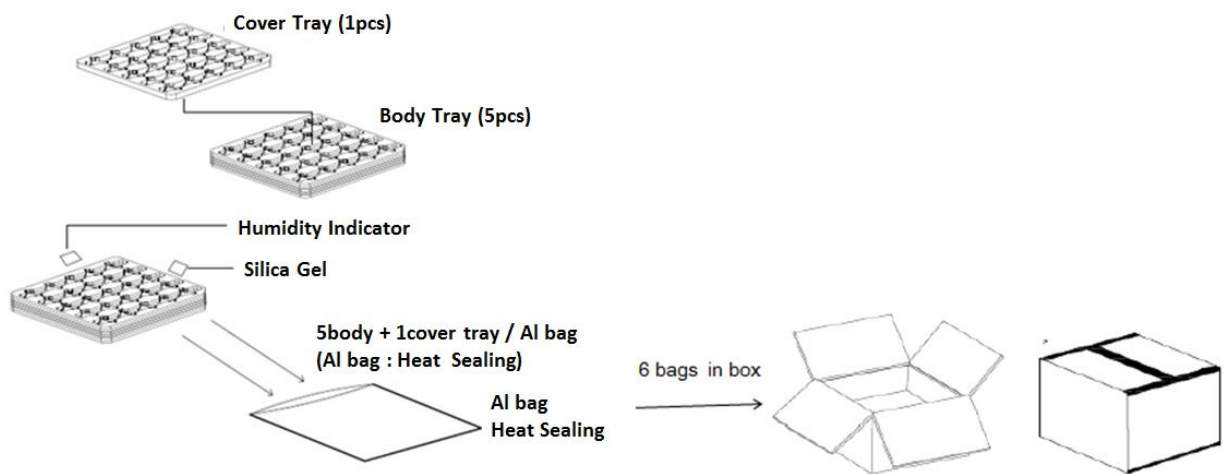

b) Tray

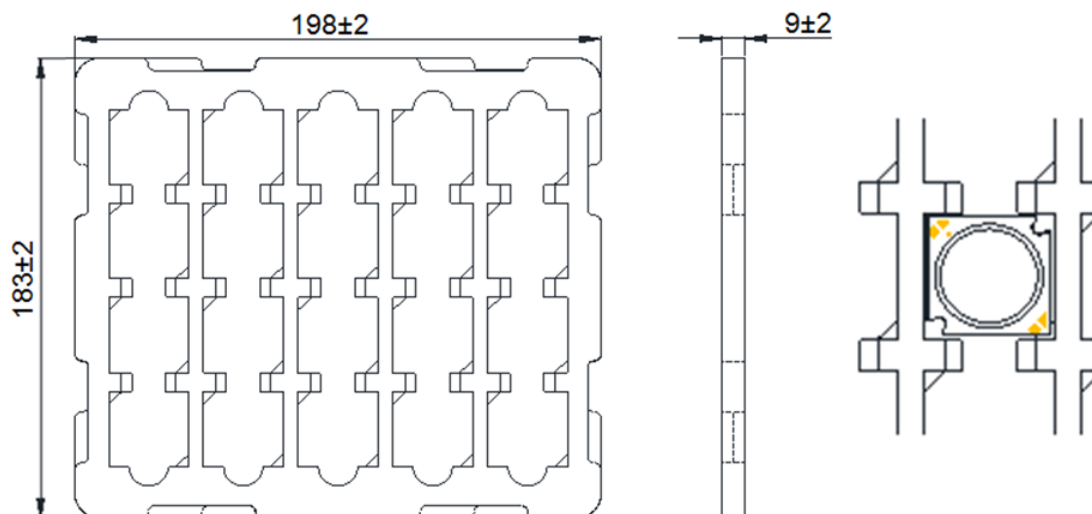

10. Precautions in Handling & Use

- 1) This device should not be used in any type of fluid such as water, oil, organic solvent, etc. Some solvent-based cleaning agent may damage the silicone resins used in the device.
- 2) LEDs must be stored in a clean environment. Shelf life of sealed bags is 12 months at temperature 0~40°C, 0~90 % RH.
- 3) After storage bag is opened, device subjected to soldering, solder reflow, or other high temperature processes must be:
 - a. Mounted within 672 hours (28 days) at an assembly line with a condition of no more than 30°C / 60 % RH, or
 - b. Stored at <10 % RH
- 4) Repack unused products with anti-moisture packing, fold to close any opening and then store in a dry place.
- 5) Devices require baking before mounting, if humidity card reading is >60 % at 23 ± 5°C.
- 6) Devices must be baked for 1 hour at 60 ± 5°C, if baking is required.
- 7) The LEDs are sensitive to the static electricity and surge current. It is recommended to use a wrist band or anti-electrostatic glove when handling the LEDs. If voltage exceeding the absolute maximum rating is applied to LEDs, it may cause damage or even destruction to LED devices. Damaged LEDs may show some unusual characteristics such as increase in leakage current, lowered turn-on voltage, or abnormal lighting of LEDs at low current.
- 8) The thermal management is one of the most critical factors for the LED lighting system. Especially the LED junction temperature should not exceed the absolute maximum rating while operation of LED lighting system.
For more information, please refer to Application Note 'Mechanical & Thermal Guide for COB'.
- 9) In case of driving LEDs around the extremely low current level, chips might exhibit different brightness due to the variation in I-V characteristics of each one. This is normal and does not adversely affect the performance of product.
- 10) VOCs (Volatile Organic Compounds) can be generated from adhesives, flux, hardener or organic additives used in luminaires (fixtures). Transparent LED silicone encapsulant is permeable to those chemicals and they may lead to a discoloration of encapsulant when they exposed to heat or light. This phenomenon can cause a significant loss of light emitted (output) from the luminaires. In order to prevent these problems, we recommend users to know the physical properties of materials used in luminaires and they must be carefully selected.
- 11) The resin area is very sensitive, please do not handle, press, touch, rub, clean, or pick by with tweezers on it. Instead, please pick at the handling area as indicated below.

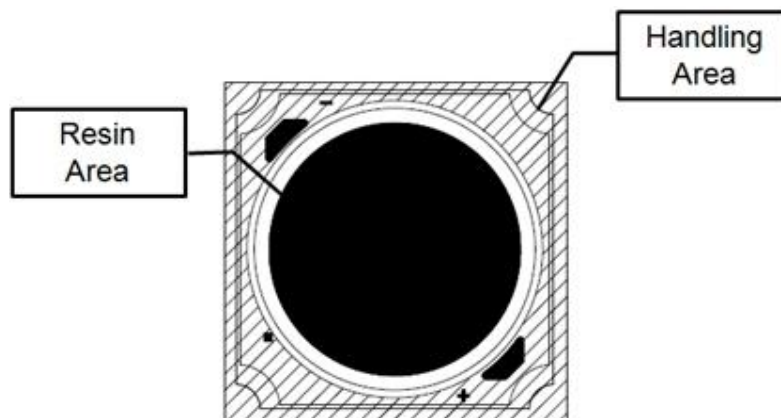

Legal and additional information.

[About Samsung Electronics Co., Ltd.](#)

Samsung Electronics Co., Ltd. inspires the world and shapes the future with transformative ideas and technologies, redefining the worlds of TVs, smartphones, wearable devices, tablets, cameras, digital appliances, printers, medical equipment, network systems and semiconductors.

We are also leading in the Internet of Things space through, among others, our Digital Health and Smart Home initiatives. We employ 307,000 people across 84 countries. To discover more, please visit our official website at www.samsung.com and our official blog at global.samsungtomorrow.com.

Copyright © 2015 Samsung Electronics Co., Ltd. All rights reserved.

Samsung is a registered trademark of Samsung Electronics Co., Ltd.

Specifications and designs are subject to change without notice. Non-metric weights and measurements are approximate. All data were deemed correct at time of creation. Samsung is not liable for errors or omissions. All brand, product, service names and logos are trademarks and/or registered trademarks

of their respective owners and are hereby recognized and acknowledged.

Samsung Electronics Co., Ltd.

95, Samsung 2-ro

Giheung-gu

Yongin-si, Gyeonggi-do, 446-711

KOREA

www.samsungled.com

SAMSUNG