

Dual color LED-3030 Series

3030A06-2760S25-U2S2P-B01

Datasheet

2700K and 6000K Dual color



FEATURES

- CCT Can be adjusted from 2700 to 6000K
- High luminous efficiency and high Color Rendering Index
- Compatible with reflow soldering process
- High power applications
- Low thermal resistance
- Long operation lif
- Wide viewing angle at 120°
- Silicone encapsulation
- Environmental friendly, RoHS compliance

APPLICATIONS

- LED strip light
- LED downlight
- LED spotlight
- Smart lighting
- Commercial lighting
- Residential lighting

Note: The information in this document is subject to change without notice.

PACKAGE DIMENSIONS

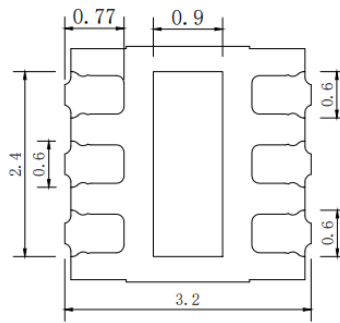
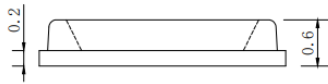
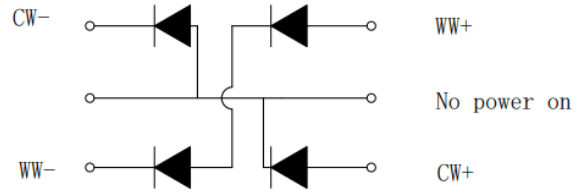
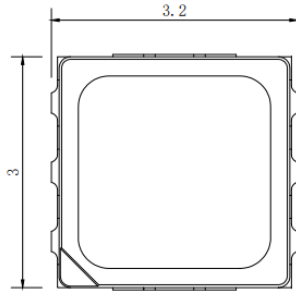

Recommended Solder Pad Design

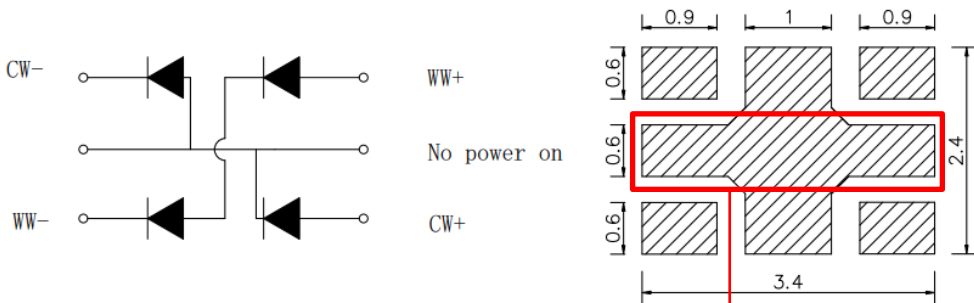

Notes(注):

This pad is used for wire connection , no power on
此焊盘用做导线连接，禁止通电

Notes:

1. All dimensions in millimeters.
2. Thickness tolerance of copper plate is $\pm 0.02\text{mm}$.
3. Thickness tolerance of product is $\pm 0.05\text{mm}$.
4. Tolerance is $\pm 0.1\text{mm}$ unless otherwise noted.

ABSOLUTE MAXIMUM RATINGS (T_j = 25°C)

Parameter	Symbol	Value	Unit
Forward current	IF	250	mA
Peak Forward Current	IFP	350	mA
Reverse Voltage	VR	10	V
Power Dissipation	Pd	1500	mW
Operating Temperature	Topr	-40~+85	°C
Storage Temperature	Tstg	-40~+100	°C
Soldering Temperature	Tsld	Reflow Soldering: 260°C for 10 seconds	
LED Junction Temperature	Tj	125	°C

Note:

I_{FP} Conditions: Pulse Width ≦ 10msec. and Duty ≦ 10%.

ELECTRO-OPTICAL CHARACTERISTICS (T_j = 25°C)

Parameter	Symbol	CCT	Test Condition	Min	Typ.	Max	Unit
Forward Voltage	V _F	All	IF=250mA	6.0	6.3	6.6	V
Viewing Angle	2θ _{1/2}	All	IF=250mA	--	120	--	deg.
Luminous Flux	Φ _v	2700K	IF=250mA	155	--	165	lm
	Φ _v	6000K	IF=250mA	170	--	180	lm
Color Rendering Index	CRI	All	IF=250mA	90	95	--	--
Red Color Rendering	R9	All	IF=250mA	50	--	--	--
Thermal Resistance	R _{th-js}	All	IF=250mA	--	15	--	°C/W

Notes :

1. Luminous flux is measured with an accuracy of ± 5%.
2. Chromaticity coordinate bins are measured with an accuracy of ± 0.01.
3. CRI is measured with an accuracy of ± 2.
4. Some color and CRI bins may have limited availability, please contact us before ordering.
5. All measurements were made under the standardized environment of Shineon

RELATIVE SPECTRAL POWER DISTRIBUTION ($T_j=25^\circ\text{C}$)

Spectrum Distribution 光谱分布

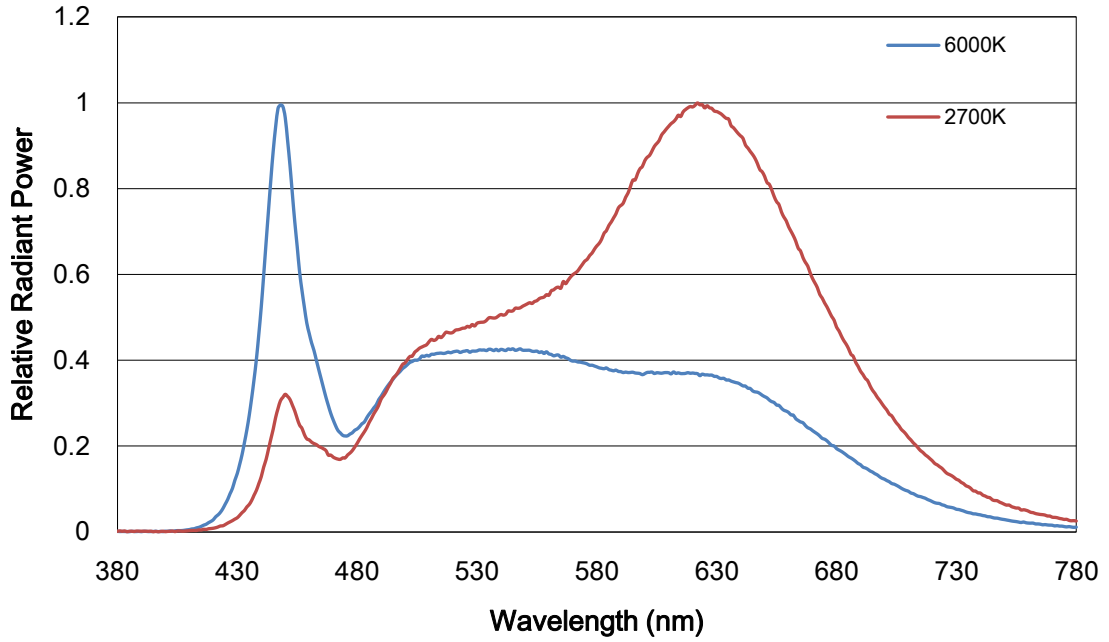

TYPICAL SPATIAL DISTRIBUTION

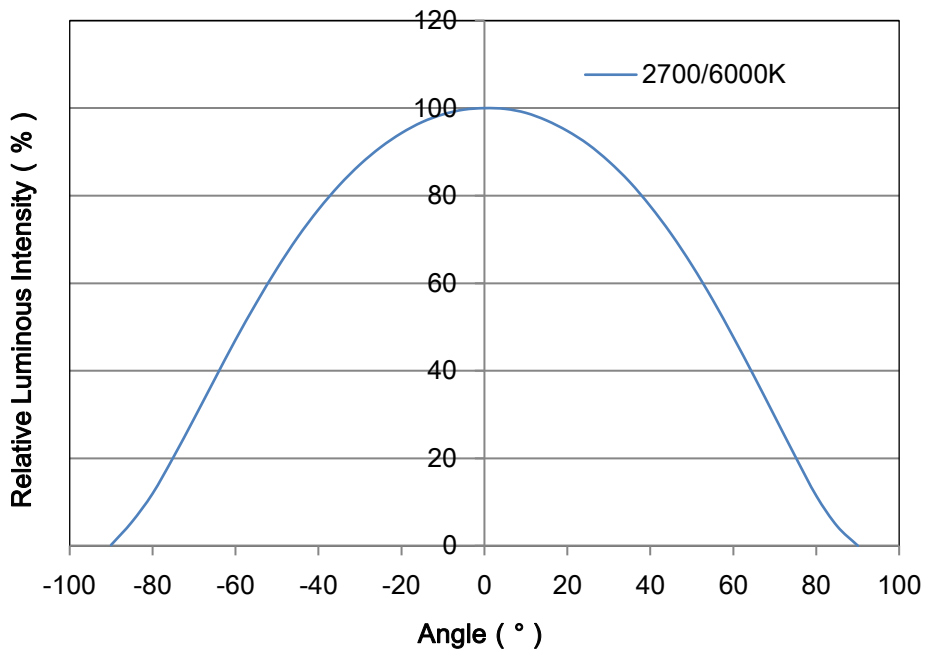

RELATIVE LUMINOUS FLUX VS. CURRENT
($T_j=25^{\circ}\text{C}$)

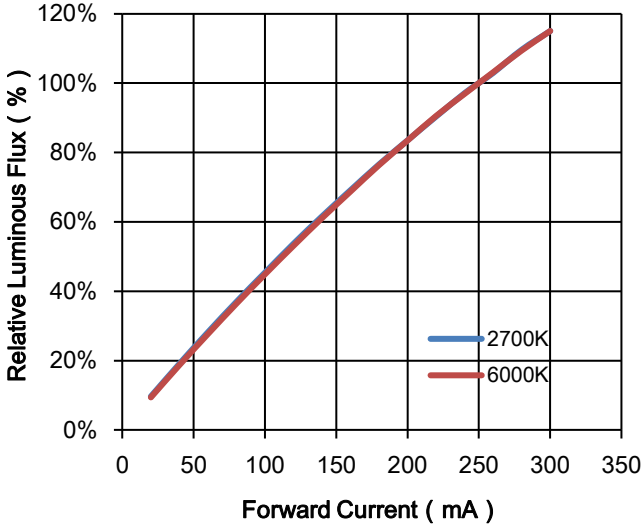

ELECTRICAL CHARACTERISTICS
($T_j=25^{\circ}\text{C}$)

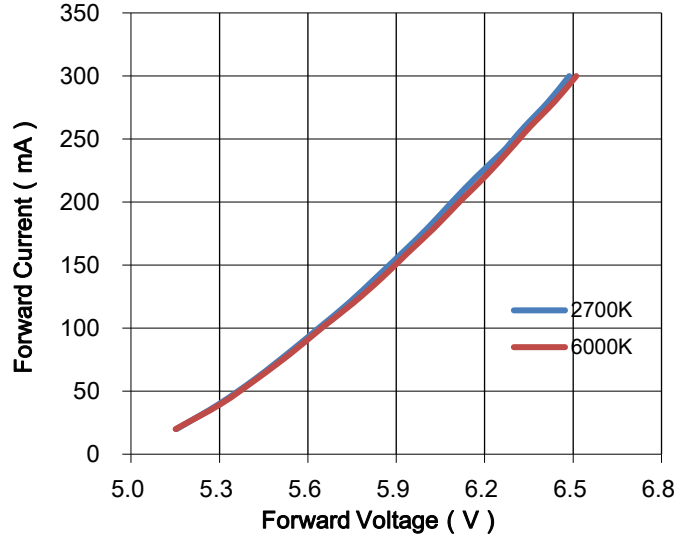

MAXIUM CURRENT VS. AMBIENT TEMPERATURE

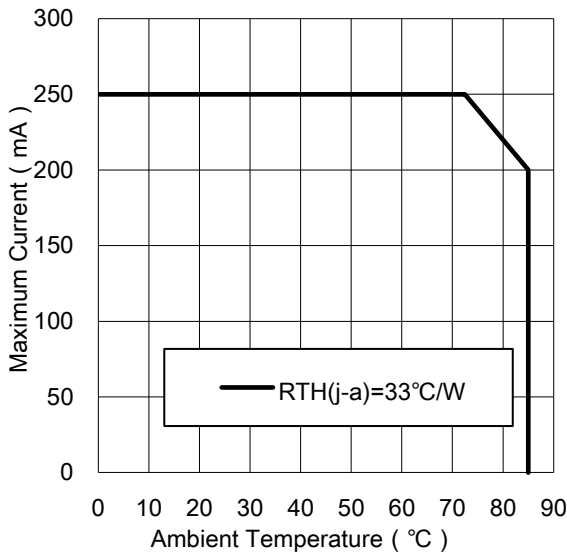

RELATIVE RADIANT FLUX VS. JUNCTION TEMPERATURE

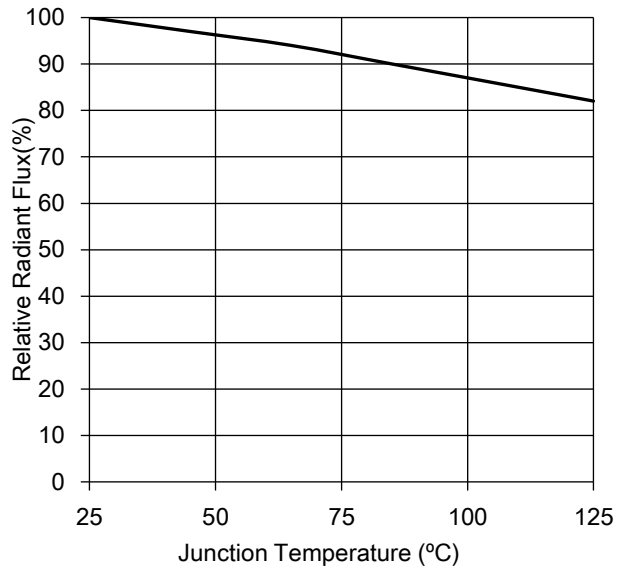

SORTING RANKS

(1) Luminous Flux (Tj=25°C)

Condition	CCT	Rank	Min.	Max.	Unit
250mA	2700K	Q53	155	165	lm
250mA	6000K	Q7	170	180	

Notes :

1. 5% tolerance for luminous intensity may be caused by measurement inaccuracy.

(2) Forward Voltage (Tj=25°C)

Condition	CCT	Rank	Min.	Max.	Unit
250mA	2700K 6000K	D0	6.0	6.2	V
		D1	6.2	6.4	
		D2	6.4	6.6	

Notes :

1. Measurement Uncertainty of the Forward Voltage : $\pm 0.1V$

(3) Chromaticity Bins ($T_j=25^{\circ}\text{C}$)

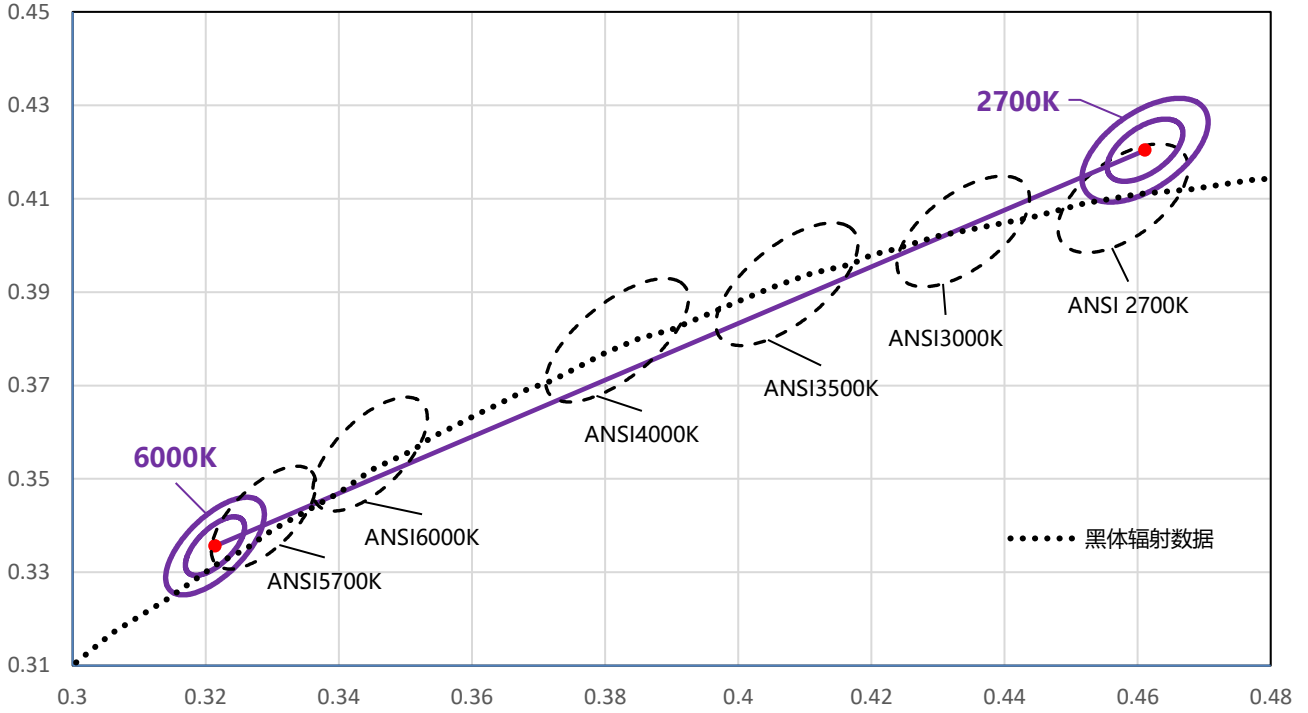

standard	Center color temperature	X	Y	θ	3step		5step	
					a	b	a	b
2700	2756K	0.4611	0.4204	53.17	0.00774	0.00411	0.01290	0.00685
6000	6018K	0.3214	0.3356	59.21	0.00708	0.003	0.0118	0.005

Notes :

1. Chromaticity coordinate bins are measured with an accuracy of ± 0.01 .

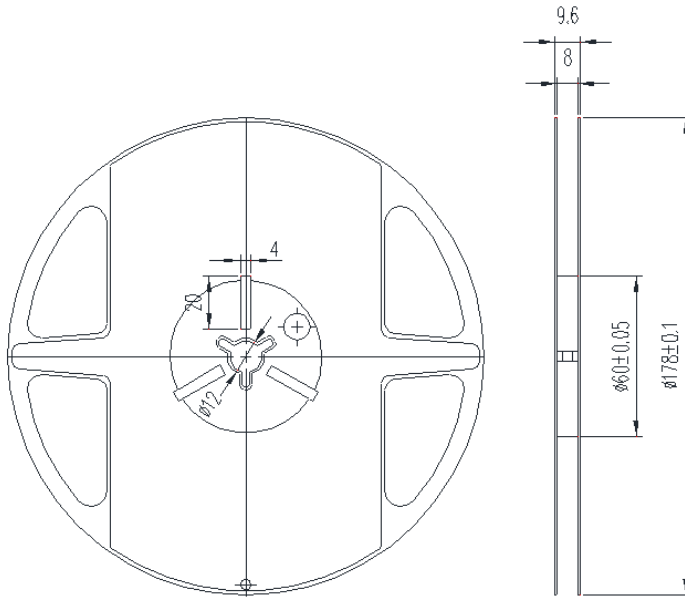
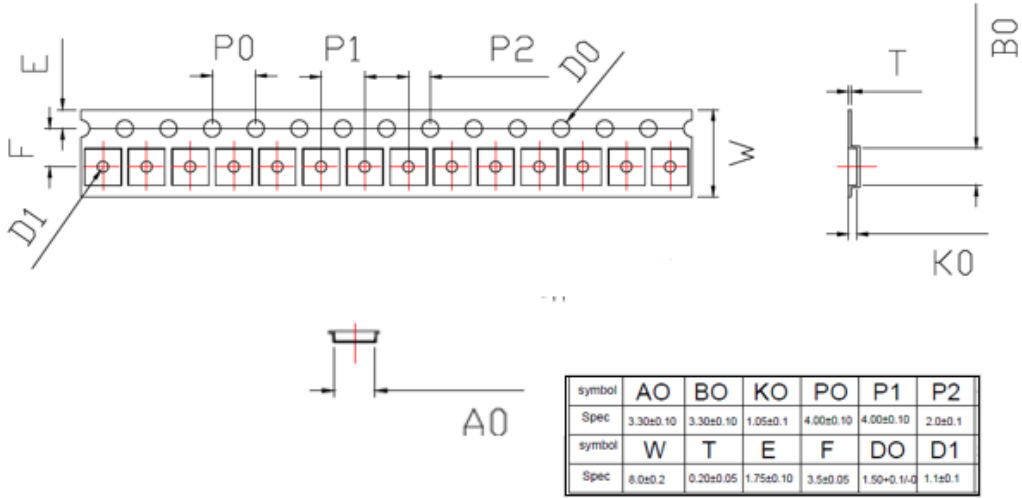
TAPE AND REEL

Notes:

- (1) Quantity : 4,000pcs/Reel
- (2) Cumulative Tolerance : Cumulative Tolerance/10 pitches to be $\pm 0.2\text{mm}$
- (3) Adhesion Strength of Cover Tape : Adhesion strength to be 0.1-0.7N when the cover tape is turned off from the carrier tape at the angle of 10° to the carrier tape
- (4) Package : P/N, Manufacturing data Code No. and quantity to be indicated on a damp proof Package.

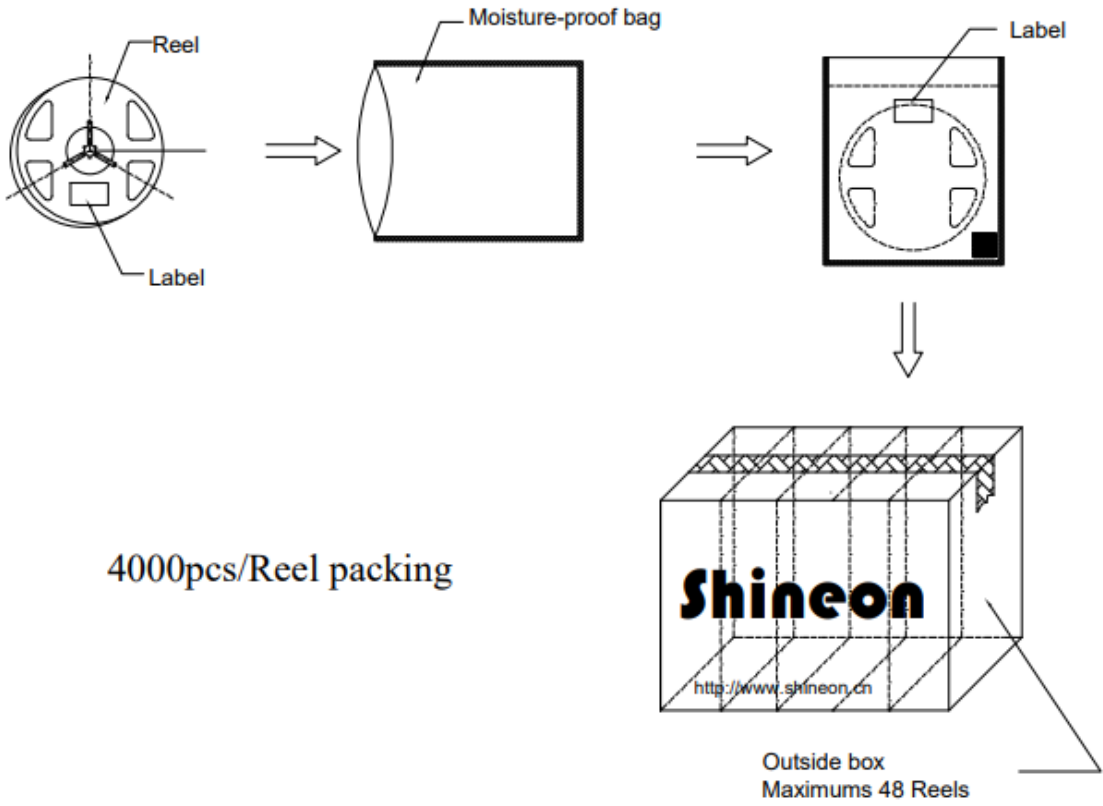
PACKAGING



REFLOW SOLDERING CHARACTERISTICS

For Reflow Process :

Preheating : 140°C~160°C±5°C,within 2 minutes.

Operation heating : 260°C(Max.) within 10 seconds.(Max)

Gradual Cooling (Avoid quenching).

Lead solder		Lead-free solder	
Pre-heat	120-150°C	Pre-heat	150-200°C
Pre-heat time	120 sec.Max.	Pre-heat time	120 sec.Max.
Peak Temperature	240°C Max.	Peak Temperature	260°C Max.
Soldering time condition	10 sec.Max.	Soldering time condition	10 sec.Max.

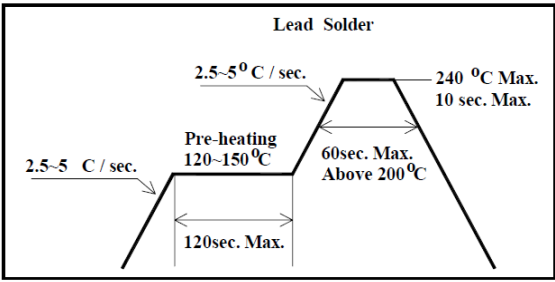
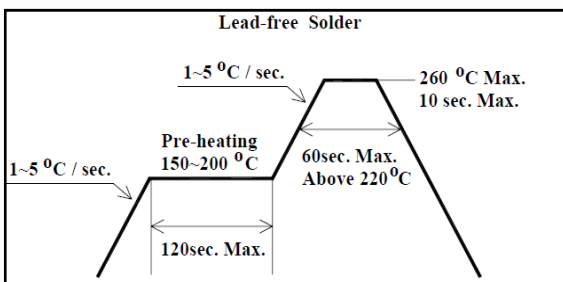
 <p>Lead Solder</p> <p>2.5~5 °C / sec.</p> <p>240 °C Max. 10 sec. Max.</p> <p>Pre-heating 120~150 °C</p> <p>60sec. Max. Above 200 °C</p> <p>2.5~5 C / sec.</p> <p>120sec. Max.</p>	 <p>Lead-free Solder</p> <p>1~5 °C / sec.</p> <p>260 °C Max. 10 sec. Max.</p> <p>Pre-heating 150~200 °C</p> <p>60sec. Max. Above 220 °C</p> <p>1~5 °C / sec.</p> <p>120sec. Max.</p>
---	--

Notes:

The encapsulated material of the LEDs is silicone . Therefore the LEDs have a soft surface on the top of package. The pressure to the top surface will be influence to the reliability of the LEDs. Precautions should be taken to avoid the strong pressure on the encapsulated part. So when using the picking up nozzle, the pressure on the silicone resin should be proper.

Reliability Test Items

Test Items	Test Duration	Number of Damaged
Steady State Operating Life of High Temperature (HTOL) Ts=85°C, IF=Max	1000hrs	0/20
Steady State Operating Life of Low Temperature (LTOL) Ta=-40°C, IF=Max	1000hrs	0/20
High Temperature Storage (HTS) 100°C	1000hrs	0/20
Low Temperature Storage (LTS) -40°C	1000hrs	0/20
Thermal Shock (TS) -45°C~125°C 15min dwell 20sec transfer	100cycles	0/20
Solder Resistance (SR) 265°C, 3X MSL	5sec	0/20
Solder Ability (SA) 245°C5sec, 95% coverage	5sec	0/11
Mechanical Shock (MS) 1500G 0.5msec pulse shock	Each6 axis	0/6
Random Vibration (RV) 6G RMS, 10-2000Hz, 10min	Per axis	0/6
Variable Vibration Frequency (VVF) 10-2000-10Hz, log or linear sweep rate, 20G for 1 min, 1.5mm each apply 3x per axis over	6hrs	0/6
Salt Spread (SS) 35°C, 30g/m2/day	48hrs	0/11

Item	Symbol	Test Condition	Criteria for Judgment	
			Min.	Max.
Forward	Vf	IF=Typical Current		U.S.L x1.1
Luminous Flux	lm	IF=Typical Current	L.S.L x0.7	
CCX&CCY	x,y	IF=Typical Current		Shift<0.02

PRECAUTION FOR USE

- (1) This device should not be used in any type of fluid such as water, oil, organic solvent, etc. When washing is required, IPA should be used.
- (2) When the LEDs are illuminating, operating current should be decided after considering the ambient maximum temperature.
- (3) LEDs must be stored to maintain a clean atmosphere. If the LEDs are stored for 3 months or more after being shipped from ShineOn, a sealed container with a nitrogen atmosphere should be used for storage.
- (4) The LEDs must be used within seven days after opening the moisture proof packing. Repack unused Products with anti-moisture packing, fold to close any opening and then store in a dry place.
- (5) The appearance and specifications of the product may be modified for improvement without notice.
- (6) This LED is sensitive to the static electricity and surge. It is recommended to use a wrist Band or anti-electrostatic glove when handling the LEDs.
- (7) On manual soldering, a solder tip must be needed as grounded for usage. If over voltage which exceeds the absolute maximum rating is applied to LEDs, it will cause damage LEDs and result in destruction. Damaged LEDs will show some unusual characteristics such as leak current remarkably increase ,turn-on voltage becomes lower and the LEDs get unlighted at low current.