

650V, 80A, Trench FS II Fast IGBT

General Description:

Using NCE's proprietary trench design and advanced FS (Field Stop) second generation technology, the 650V Trench FSII IGBT offers superior conduction and switching performances, and easy parallel operation;

Features

- Trench FSII Technology offering
- Very low $V_{CE(sat)}$
- High speed switching
- Positive temperature coefficient in $V_{CE(sat)}$
- Very tight parameter distribution
- High ruggedness, temperature stable behavior

Application

- Air Condition
- Inverters
- Motor drives

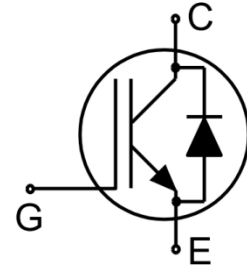

Schematic diagram

Package Marking and Ordering Information

Device	Device Package	Device Marking
NCE80TD65BT	TO-247	NCE80TD65BT



TO-247

Absolute Maximum Ratings ($T_C=25^\circ\text{C}$ unless otherwise noted)

Symbol	Parameter	Value	Units
V_{CES}	Collector-Emitter Voltage	650	V
V_{GES}	Gate- Emitter Voltage	± 30	V
	Gate- Emitter Voltage (AC)	± 40	V
I_C	Collector Current	160	A
	Collector Current @ $T_C = 100^\circ\text{C}$	80	A
I_{Cpuls}	Pulsed Collector Current, t_p limited by T_{jmax}	320	A
-	Turn off safe operating area, $V_{CE}=650\text{V}$, $T_j=175^\circ\text{C}$	320	A
I_F	Diode Continuous Forward Current @ $T_C = 100^\circ\text{C}$	80	A
I_{FM}	Diode Maximum Forward Current	320	A
P_D	Power Dissipation @ $T_C = 25^\circ\text{C}$	468	W
	Power Dissipation @ $T_C = 100^\circ\text{C}$	234	W
T_J, T_{stg}	Operating Junction and Storage Temperature Range	-55 to +175	$^\circ\text{C}$
T_L	Maximum Temperature for Soldering	260	$^\circ\text{C}$
t_{sc}	Short circuit withstand time $V_{GE}=15\text{V}$, $V_{CC}\leq 400\text{V}$, Allowed number of short circuits < 1000 Time between short circuits: $\geq 1.0\text{s}$, $T_j \leq 150^\circ\text{C}$	5	μs

Thermal Characteristic

Symbol	Parameter	Value	Units
R _{θJC}	Thermal Resistance, Junction to case for IGBT	0.32	°C/W
R _{θJC}	Thermal Resistance, Junction to case for Diode	0.44	°C/W
R _{θJA}	Thermal Resistance, Junction to Ambient	40	°C/W

Electrical Characteristics (T_C=25°C unless otherwise noted)

Symbol	Parameter	Conditions	Value			Units	
			Min.	Typ.	Max.		
Static Characteristics							
V _{(BR)CES}	Collector-Emitter Breakdown Voltage	V _{GE} =0V, I _{CE} =1mA	650	--	--	V	
I _{CES}	Collector-Emitter Leakage Current	V _{GE} =0V, V _{CE} =650V	--	--	75	uA	
I _{GES(F)}	Gate to Emitter Forward Leakage	V _{GE} =+30V, V _{CE} =0V	--	--	200	nA	
I _{GES(R)}	Gate to Emitter Reverse Leakage	V _{GE} =-30V, V _{CE} =0V	--	--	200	nA	
V _{CE(sat)}	Collector-Emitter Saturation Voltage	I _C =80A	T _J =25°C	--	1.7	1.9	V
		V _{GE} =15V		T _J =175°C	--	1.9	--
V _{GE(th)}	Gate Threshold Voltage	I _C =1mA, V _{CE} =V _{GE}	4.0	5.0	6.0	V	
Dynamic Characteristics							
C _{ies}	Input Capacitance	V _{CE} =25V, V _{GE} =0V, f=1MHz	--	9188	--	pF	
C _{oes}	Output Capacitance		--	258	--		
C _{res}	Reverse Transfer Capacitance		--	181	--		
Q _g	Total Gate Charge	V _{CC} =480V, I _C =80A, V _{GE} =15V	--	331	--	nC	
Q _{ge}	Gate to Emitter Charge		--	74	--		
Q _{gc}	Gate to Collector Charge		--	136	--		
I _{C(SC)}	Short circuit collector current Max.1000 short circuits Time between short circuits: ≥1.0s	V _{GE} =15V, V _{CC} ≤400V, t _{sc} ≤5us, T _J ≤150°C	--	450	--	A	
Switching Characteristics							
t _{d(ON)}	Turn-on Delay Time	V _{CC} =400V, I _C =80A, V _{GE} =0/15V, R _g =5Ω, Inductive Load	--	19	--	ns	
t _r	Rise Time		--	17	--		
t _{d(OFF)}	Turn-Off Delay Time		--	172	--		
t _f	Fall Time		--	20	--		
E _{on}	Turn-On Switching Loss		V _{CC} =400V, I _C =80A, V _{GE} =0/15V, R _g =5Ω, T _J =175°C	--	1.6	--	mJ
E _{off}	Turn-Off Switching Loss			--	1.2	--	
E _{ts}	Total Switching Loss			--	2.8	--	
E _{on}	Turn-On Switching Loss			--	2.0	--	
E _{off}	Turn-Off Switching Loss	V _{CC} =400V, I _C =80A, V _{GE} =0/15V, R _g =5Ω, T _J =175°C	--	1.6	--	mJ	
E _{ts}	Total Switching Loss		--	3.6	--		

Electrical Characteristics of the Diode ($T_c= 25^{\circ}\text{C}$ unless otherwise specified)

Symbol	Parameter	Conditions	Rating			Units
			Min.	Typ.	Max.	
V_{FM}	Diode Forward Voltage	$I_F=80\text{A}$	--	1.75	2.4	V
T_{rr}	Reverse Recovery Time	$I_F=80\text{A}$, $di/dt=200\text{A}/\mu\text{s}$	--	194	--	ns
I_{RRM}	Diode Peak Reverse Recovery Current		--	2.8	--	A
Q_{rr}	Reverse Recovery Charge		--	0.2	--	μC

Test Circuit

1) Gate Charge Test Circuit

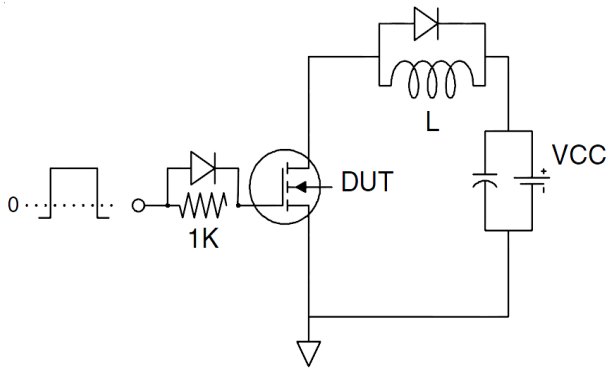

2) Switch Time Test Circuit

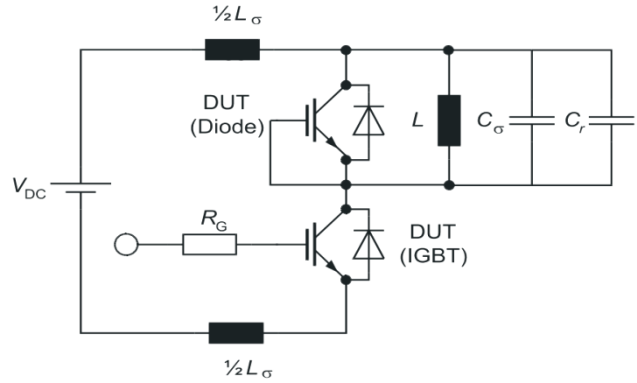

Switching characteristics

1) Definition of switching times

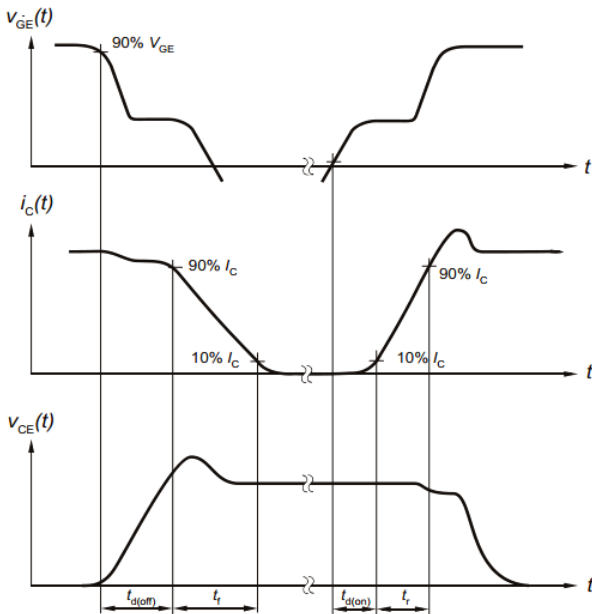

2) Definition of switching losses

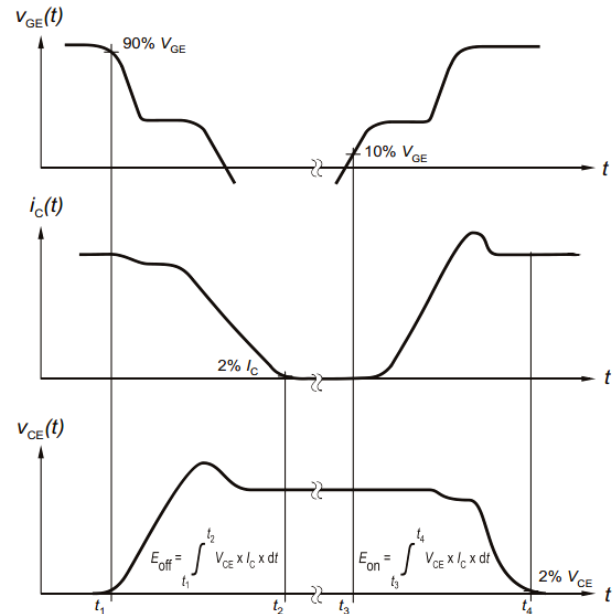

3) Definition of diode switching characteristics

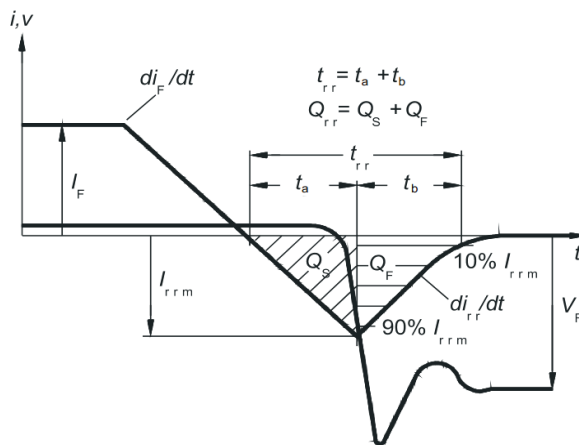

Typical Electrical and Thermal Characteristics

Figure 1 Output Characteristics

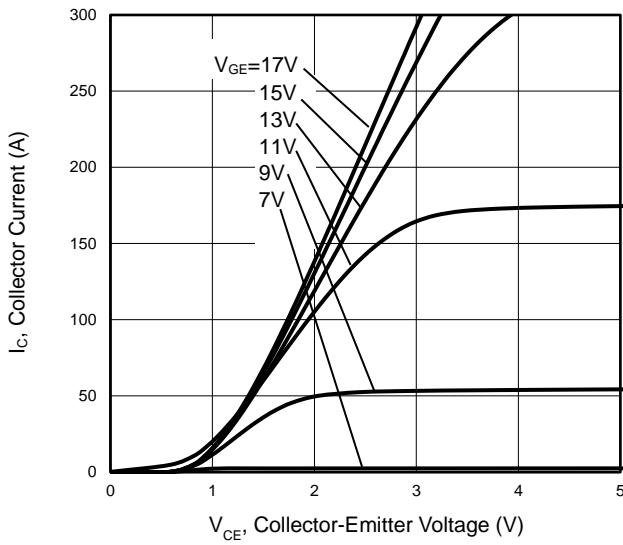

Figure 2 Transfer Characteristics

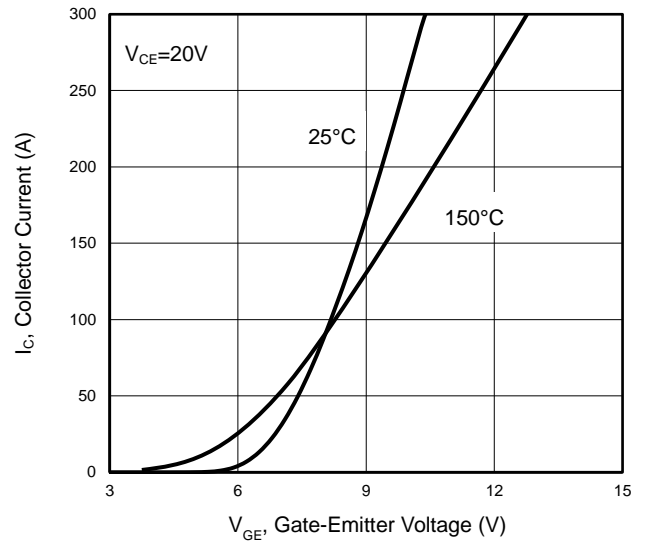

Figure 3 $V_{CE(sat)}$ vs. Temperature

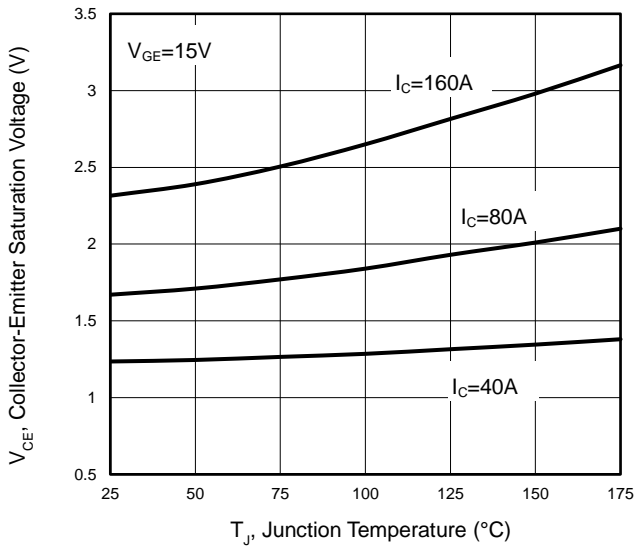

Figure 4 Saturation Voltage vs. V_{GE}

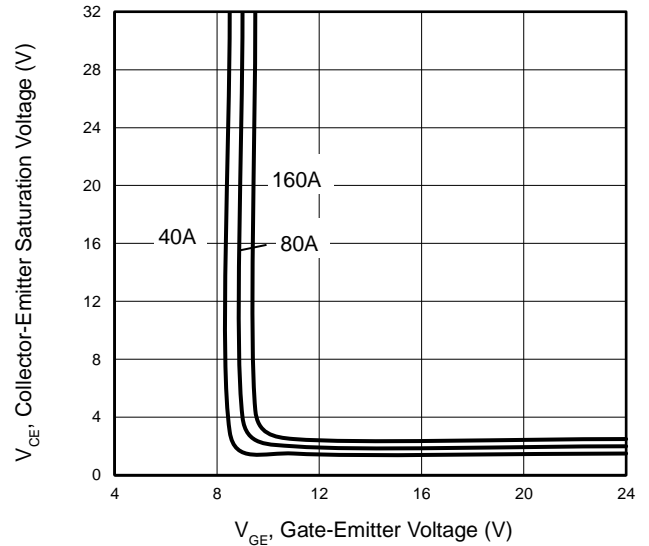

Figure 5 Capacitance Characteristics

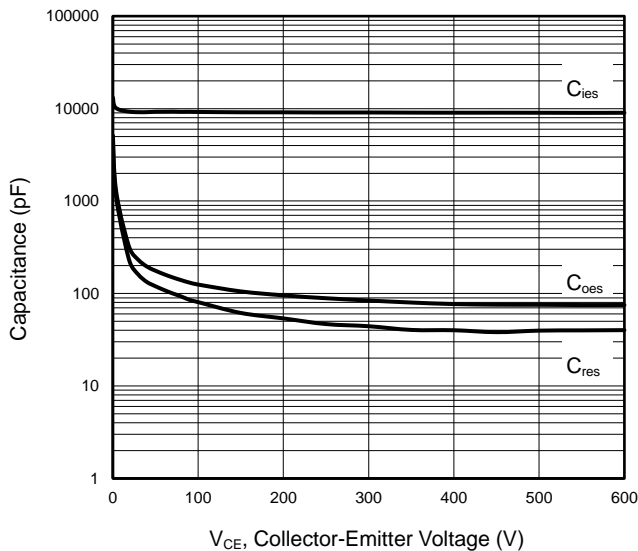
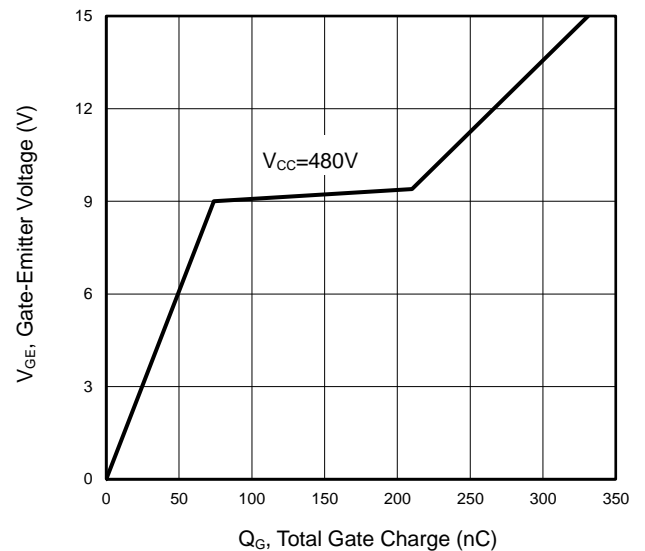

Figure 6 Gate Charge Wave Form



Typical Electrical and Thermal Characteristics

Figure 7 Forward Characteristics

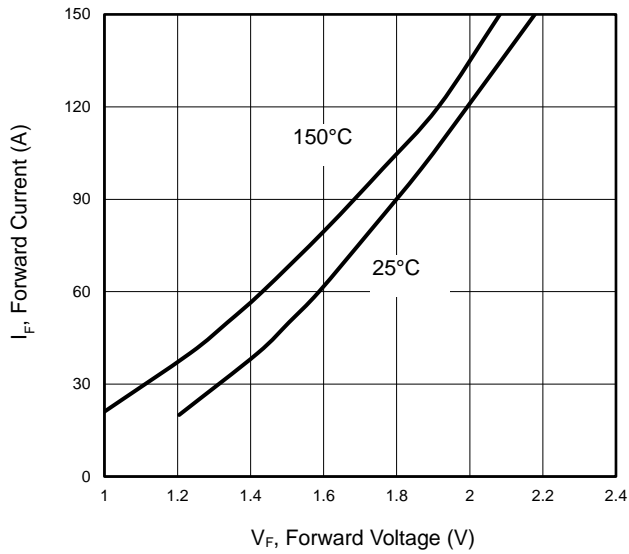

Figure 8 V_F vs. Temperature

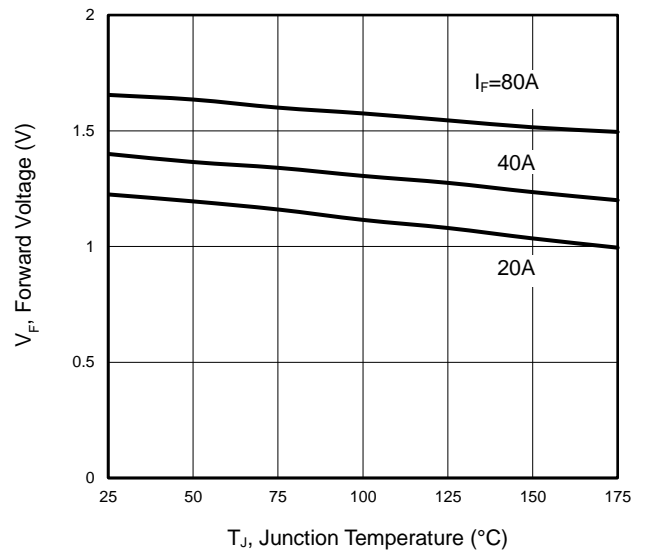

Figure 9 $V_{GE(th)}$ vs. Temperature

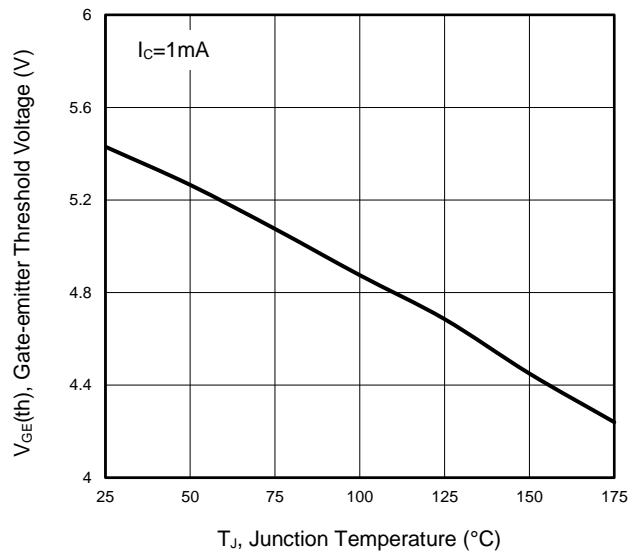

Figure 10 $V_{CE(sat)}$ vs. Collector Current

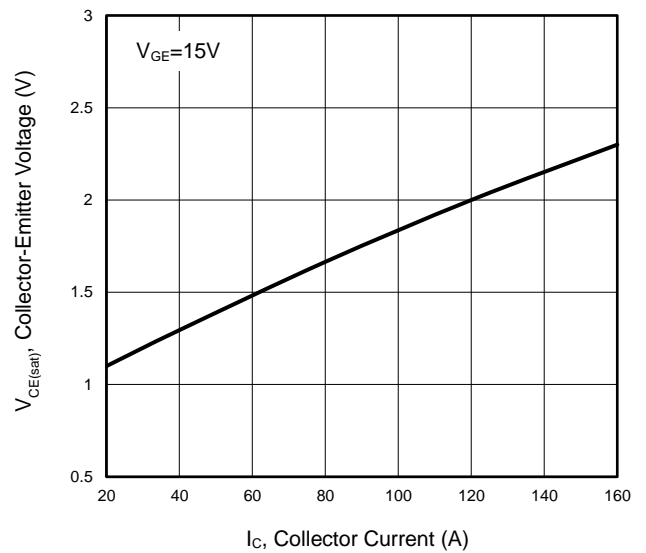

Figure 11 P_{tot} vs. Case Temperature

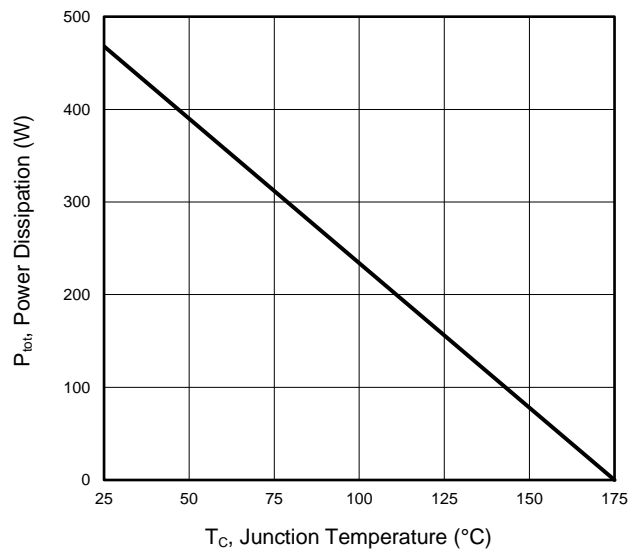
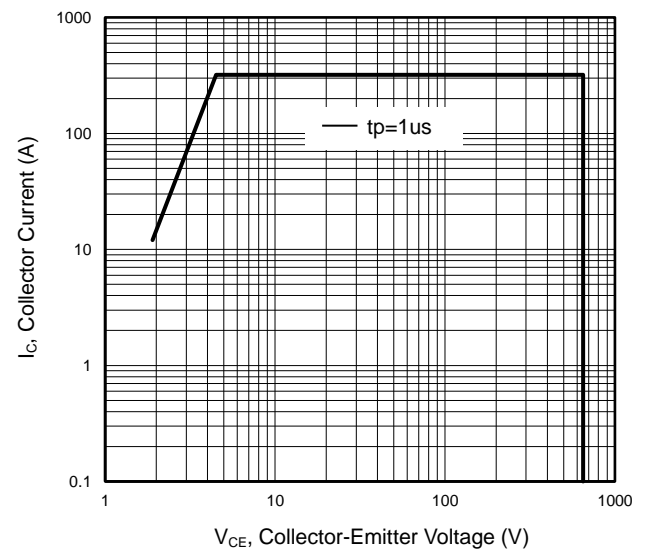

Figure 12 Forward Bias Safe Operating Area



Typical Electrical and Thermal Characteristics

Figure 13 Switching Loss vs. R_G

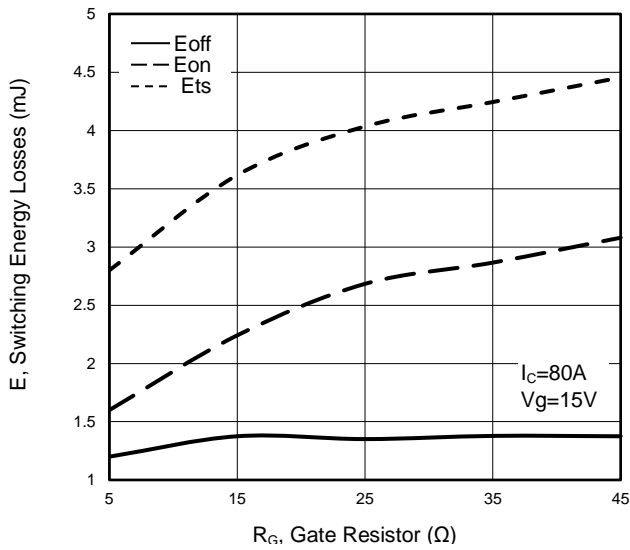

Figure 14 Switching Loss vs. Collector Current

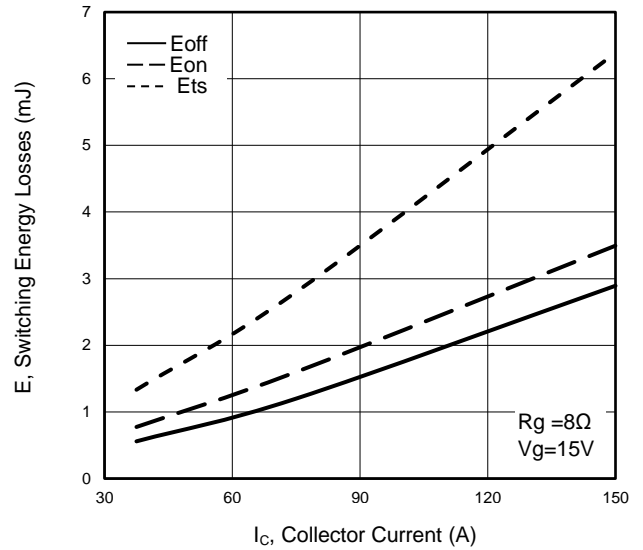

Figure 15 Switching Energy vs. Temperature

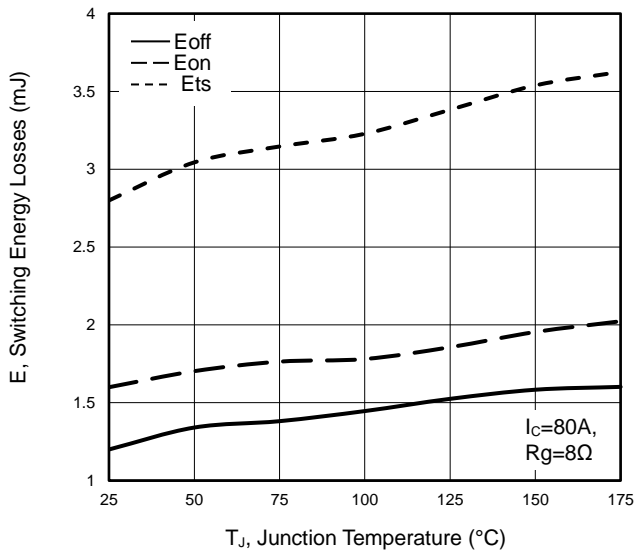

Figure 16 Switching Loss vs. Collector Current

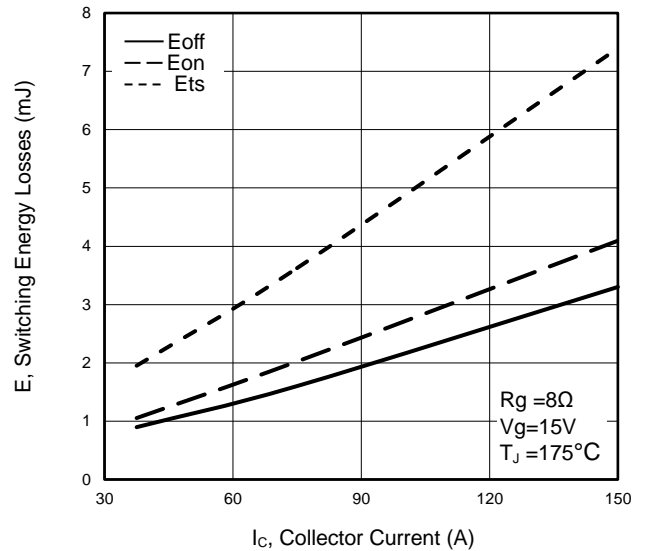

Figure 17 V_{CES} vs. Case Temperature

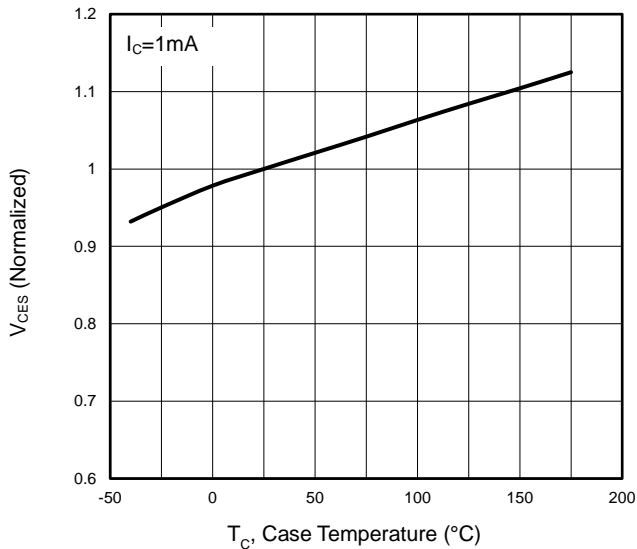
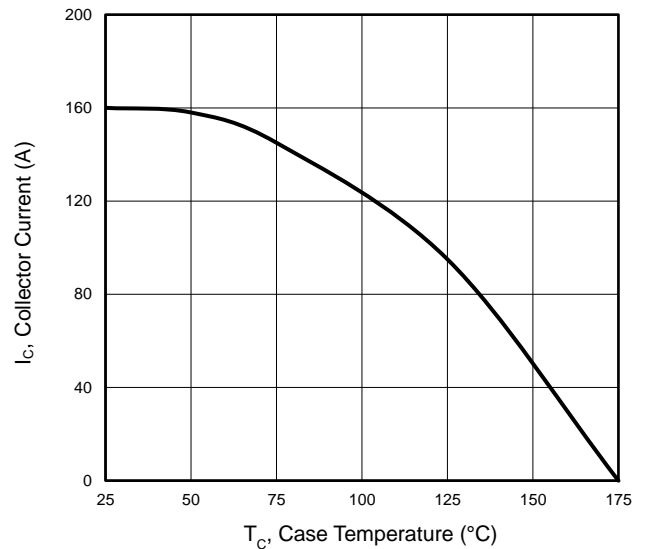

Figure 18 I_C vs. Temperature



Typical Electrical and Thermal Characteristics

Figure 19 Switching Time vs. I_C

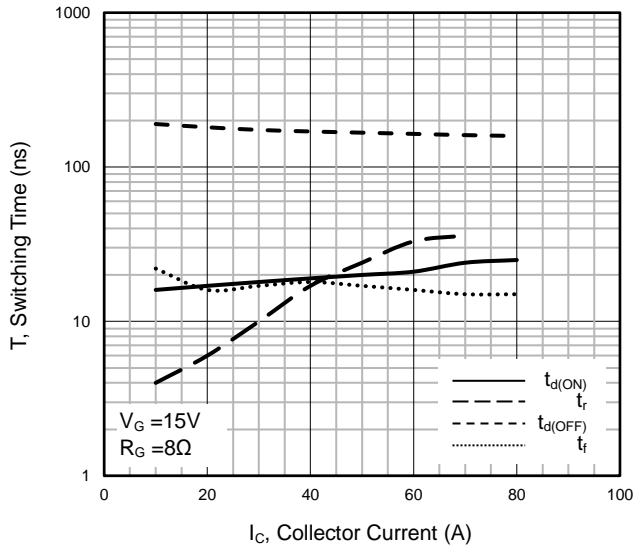

Figure 20 Switching Time vs. R_G

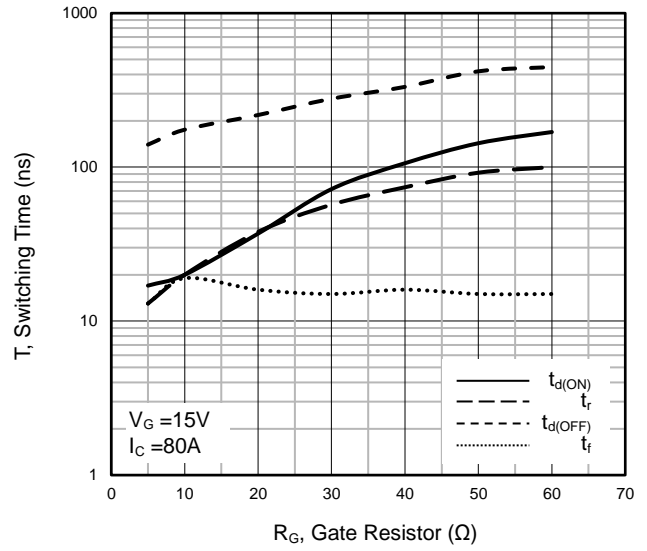

Figure 21 Switching Time vs. I_C

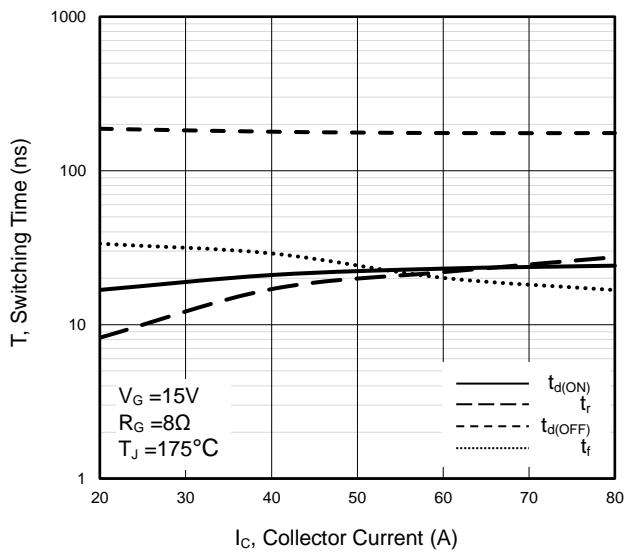
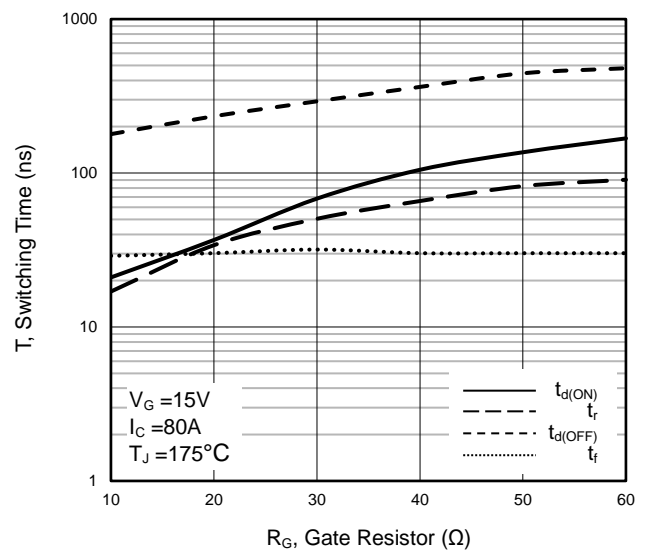
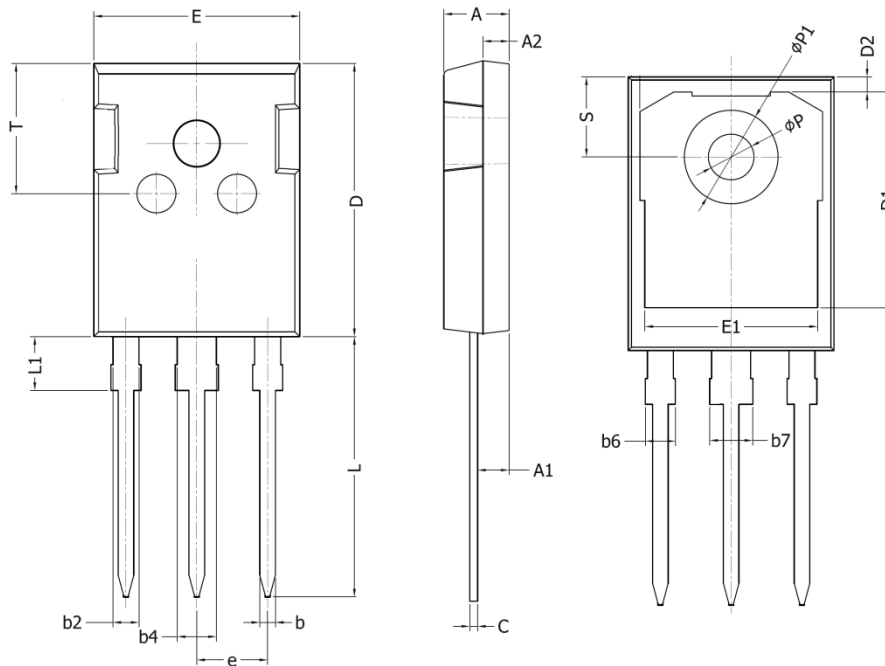

Figure 22 Switching Time vs. R_G



TO-247-P Package Information



Symbol	Dimensions In Millimeters		Dimensions In Inches	
	Min.	Max.	Min.	Max.
A	4.90	5.10	0.193	0.201
A1	2.31	2.51	0.091	0.099
A2	1.9	2.1	0.075	0.083
b	1.16	1.26	0.046	0.050
b2	1.96	2.06	0.077	0.081
b4	2.96	3.06	0.117	0.120
b6	-	2.25	-	0.089
b7	-	3.25	-	0.128
C	0.59	0.66	0.023	0.026
D	20.90	21.10	0.823	0.831
D1	16.25	16.85	0.640	0.663
D2	1.05	1.35	0.041	0.053
E	15.70	15.90	0.618	0.626
E1	13.10	13.50	0.516	0.531
e	5.436 BSC		0.214 BSC	
L	19.80	20.10	0.780	0.791
L1	-	4.30	-	0.169
P	3.40	3.60	0.134	0.142
P1	7.00	7.40	0.276	0.291
S	6.05	6.25	0.238	0.246
T	9.80	10.20	0.386	0.402

TO-247-B Package Information

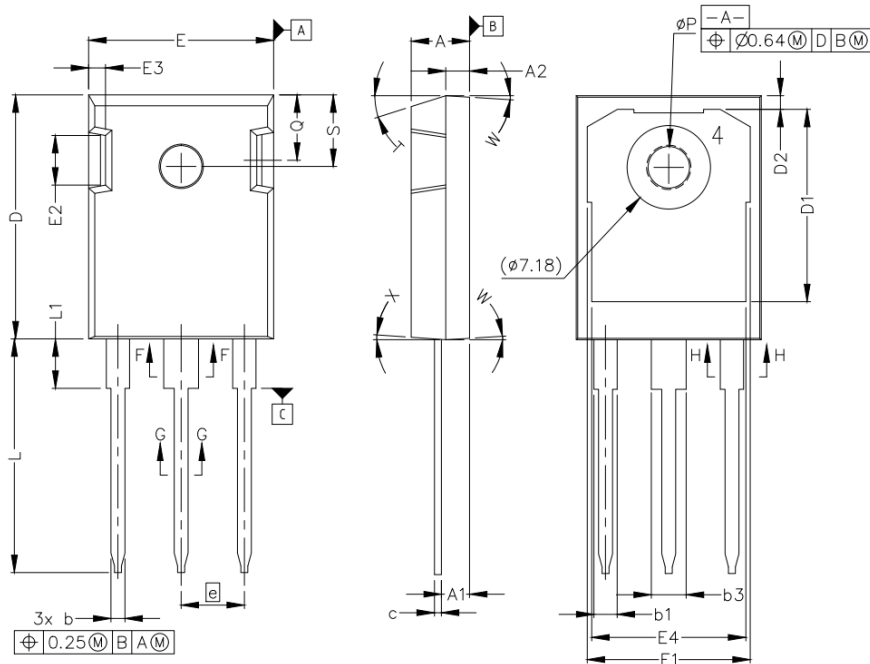

Symbol	Dimensions In Millimeters		Dimensions In Inches	
	Min.	Max.	Min.	Max.
A	4.83	5.21	0.190	0.205
A1	2.29	2.54	0.090	0.100
A2	1.91	2.16	0.075	0.085
b	1.07	1.33	0.042	0.052
b1	1.91	2.41	0.075	0.095
b3	2.87	3.38	0.113	0.133
c	0.55	0.68	0.022	0.027
D	20.80	21.10	0.819	0.831
D1	16.25	17.65	0.640	0.695
D2	0.95	1.25	0.037	0.049
E	15.75	16.13	0.620	0.635
E1	13.10	14.15	0.516	0.557
E2	3.68	5.10	0.145	0.201
E3	1.00	1.90	0.039	0.075
E4	12.38	13.43	0.487	0.529
e	5.44 BSC		0.214 BSC	
N	3.00		0.118	
L	19.81	20.32	0.780	0.800
L1	4.10	4.40	0.161	0.173
P	3.51	3.65	0.138	0.144
Q	5.49	6.00	0.216	0.236
S	6.04	6.30	0.238	0.248

Attention:

- Any and all NCE power products described or contained herein do not have specifications that can handle applications that require extremely high levels of reliability, such as life-support systems, aircraft's control systems, or other applications whose failure can be reasonably expected to result in serious physical and/or material damage. Consult with your NCE power representative nearest you before using any NCE power products described or contained herein in such applications.
- NCE power assumes no responsibility for equipment failures that result from using products at values that exceed, even momentarily, rated values (such as maximum ratings, operating condition ranges, or other parameters) listed in products specifications of any and all NCE power products described or contained herein.
- Specifications of any and all NCE power products described or contained herein stipulate the performance, characteristics, and functions of the described products in the independent state, and are not guarantees of the performance, characteristics, and functions of the described products as mounted in the customer's products or equipment. To verify symptoms and states that cannot be evaluated in an independent device, the customer should always evaluate and test devices mounted in the customer's products or equipment.
- NCE power Semiconductor CO.,LTD. strives to supply high-quality high-reliability products. However, any and all semiconductor products fail with some probability. It is possible that these probabilistic failures could give rise to accidents or events that could endanger human lives, that could give rise to smoke or fire, or that could cause damage to other property. When designing equipment, adopt safety measures so that these kinds of accidents or events cannot occur. Such measures include but are not limited to protective circuits and error prevention circuits for safe design, redundant design, and structural design.
- In the event that any or all NCE power products(including technical data, services) described or contained herein are controlled under any of applicable local export control laws and regulations, such products must not be exported without obtaining the export license from the authorities concerned in accordance with the above law.
- No part of this publication may be reproduced or transmitted in any form or by any means, electronic or mechanical, including photocopying and recording, or any information storage or retrieval system, or otherwise, without the prior written permission of NCE power Semiconductor CO.,LTD.
- Information (including circuit diagrams and circuit parameters) herein is for example only ; it is not guaranteed for volume production. NCE power believes information herein is accurate and reliable, but no guarantees are made or implied regarding its use or any infringements of intellectual property rights or other rights of third parties.
- Any and all information described or contained herein are subject to change without notice due to product/technology improvement, etc. When designing equipment, refer to the "Delivery Specification" for the NCE power product that you intend to use.
- This catalog provides information as of Sep.2010. Specifications and information herein are subject to change without notice.