

PROPRIETARY NOTE

THIS SPECIFICATION IS THE PROPERTY OF BOE BJ AND SHALL NOT BE REPRODUCED OR COPIED WITHOUT THE WRITTEN PERMISSION OF BOE BJ AND MUST BE RETURNED TO BOE BJ UPON ITS REQUEST



SPEC. NUMBER

PRODUCT GROUP

REV.

ISSUE DATE

PAGE

S8-65-8A-292

DID

P0

2019.08.20

1 OF 35

DV550FHM-NVD Preliminary Product Specification P0

BEIJING BOE Display TECHNOLOGY CO., LTD

PROPRIETARY NOTE

THIS SPECIFICATION IS THE PROPERTY OF BOE BJ AND SHALL NOT BE REPRODUCED OR COPIED WITHOUT THE WRITTEN PERMISSION OF BOE BJ AND MUST BE RETURNED TO BOE BJ UPON ITS REQUEST



SPEC. NUMBER

PRODUCT GROUP

REV.

ISSUE DATE

PAGE

S8-65-8A-292

DID

P0

2019.08.20

2 OF 35

REVISION HISTORY

Preliminary specification

Final specification

Revision No.

Page

Description of changes

Date

Prepared

P0

-

Initial Release

2019/08/20

SHI HAIJUN

PROPRIETARY NOTE

THIS SPECIFICATION IS THE PROPERTY OF BOE BJ AND SHALL NOT BE REPRODUCED OR COPIED WITHOUT THE WRITTEN PERMISSION OF BOE BJ AND MUST BE RETURNED TO BOE BJ UPON ITS REQUEST



SPEC. NUMBER

PRODUCT GROUP

REV.

ISSUE DATE

PAGE

S8-65-8A-292

DID

P0

2019.08.20

3 OF 35

Contents

No	ITEM	Page
	REVISIONS HISTORY	2
	CONTENTS	3
1	GENERAL DESCRIPTION	4
	1.1 Introduction	
	1.2 Features	
	1.3 Applications	
	1.4 General Specification	
2	ABSOLUTE MAXIMUM RATINGS	6
3	ELECTRICAL SPECIFICATIONS	7
	3.1 Open Cell Electrical Specifications	
	3.2 Converter Electrical Specifications	
4	INTERFACE CONNECTION	9
	4.1 Open Cell Input Signal & Power	
	4.2 BLU Input Signal & Power	
	4.3 LVDS Receiver Type	
5	SIGNAL TIMING SPECIFICATIONS	14
	5.1 Timing Parameters	
	5.2 Signal Timing Waveform	
	5.3 Input Signals, Basic Display Colors & Gray Scale Of Colors	
	5.4 Power Sequence	
6	OPTICAL SPECIFICATIONS	20
7	MECHANICAL CHARACTERISTICS	23
8	RELIABILITY	24
9	PRODUCT SERIAL NUMBER	25
10	PACKING INFORMATION	26
11	PRECAUTIONS	28
12	APPENDIX	33

PROPRIETARY NOTE

THIS SPECIFICATION IS THE PROPERTY OF BOE BJ AND SHALL NOT BE REPRODUCED OR COPIED WITHOUT THE WRITTEN PERMISSION OF BOE BJ AND MUST BE RETURNED TO BOE BJ UPON ITS REQUEST

BOE

SPEC. NUMBER

S8-65-8A-292

PRODUCT GROUP

DID

REV.

P0

ISSUE DATE

2019.08.20

PAGE

4 OF 35

1.0 GENERAL DESCRIPTION

1.1 Introduction

DV550FHM-NVD is a color active matrix TFT LCD Module using amorphous silicon TFT's (Thin Film Transistors) as an active switching devices. This module is A-A 0.88mm ELFD(Extra Large Format Display Video Wall). This module has a 55 inch diagonally measured active area with FHD resolutions (1920 horizontal by 1080 vertical pixel array). Each pixel is divided into RED, GREEN, BLUE dots which are arranged in vertical stripe and this module can display 16.7M colors. The TFT-LCD panel used for this module is adapted for a low reflection and higher color type.

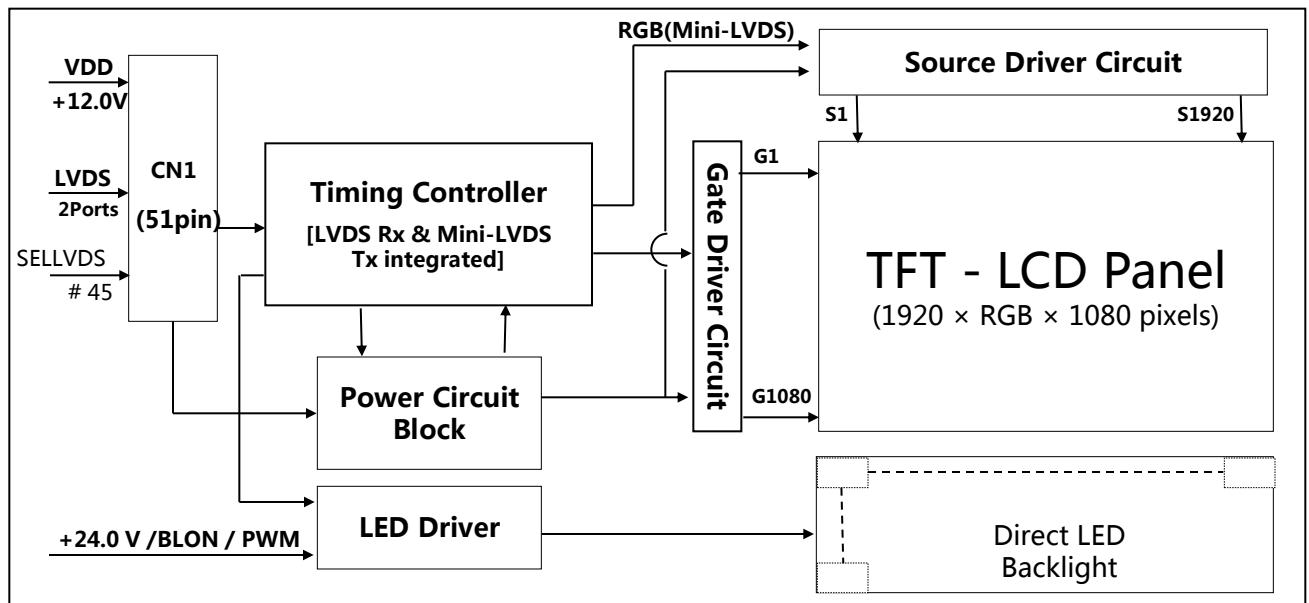

1.2 Features

- A-A 0.88mm Exrta-LFD
- LVDS interface with 2 pixel / clock
- High-speed response
- 8-bit color depth, display 16.7M colors
- Direct LED Backlight
- DE (Data Enable) only mode
- ADS technology is applied for high display quality
- RoHS compliant

PROPRIETARY NOTE

THIS SPECIFICATION IS THE PROPERTY OF BOE BJ AND SHALL NOT BE REPRODUCED OR COPIED WITHOUT THE WRITTEN PERMISSION OF BOE BJ AND MUST BE RETURNED TO BOE BJ UPON ITS REQUEST



SPEC. NUMBER

PRODUCT GROUP

REV.

ISSUE DATE

PAGE

S8-65-8A-292

DID

P0

2019.08.20

5 OF 35

1.3 Application

- High Definition Public Monitor
- Landscape and Portrait Display

1.4 General Specification

< Table 1. General Specifications >

Parameter	Specification	Unit	Remark
MDL Outline	1210.48(H)x 681.28(V)	mm	Without side seal
Active area	1209.6(H) × 680.4 (V)	mm	
Number of pixels	1920(H) × 1080(V)	pixels	
Pixel pitch	210(H) × RGB × 630(V)	um	
Pixel arrangement	Pixels RGB Vertical stripe		
Display colors	16.7M(8bits-true)	colors	
Display mode	Normally Black		
Brightness	500(Typ.)	nit	Center point
MDL Thickness	38.3(Body)/46(Mount)	mm	
Weight	14600	gram	
Power Consumption	202(Typ.)	Watt	
Surface Treatment	Haze25% ,3H, (Front Polarizer)		
Life Time	50,000	Hrs	Note 1

Note 1 : The life time is determined as the time which luminance of LED is 50% compare to the initial value at the typical LED current on condition of continuous operating in LCM state at 25±2 °C

PROPRIETARY NOTE

THIS SPECIFICATION IS THE PROPERTY OF BOE BJ AND SHALL NOT BE REPRODUCED OR COPIED WITHOUT THE WRITTEN PERMISSION OF BOE BJ AND MUST BE RETURNED TO BOE BJ UPON ITS REQUEST



SPEC. NUMBER S8-65-8A-292	PRODUCT GROUP DID	REV. P0	ISSUE DATE 2019.08.20	PAGE 6 OF 35
------------------------------	----------------------	------------	--------------------------	-----------------

2.0 ABSOLUTE MAXIMUM RATINGS

The followings are maximum values which, if exceed, may cause faulty operation or damage to the unit. The operational and non-operational maximum voltage and current values are listed in Table 2.

< Table 2. Absolute Specifications >

[VSS=GND=0V]

Parameter	Symbol	Min.	Max.	Unit	Remark
Power Supply Voltage	V_{DD}	$V_{SS}-0.3$	13.2	V	Ta = 25 °C
Logic Supply Voltage	V_{IN}	$V_{SS}-0.3$	$V_{DD}+0.3$	V	
Operating Temperature	T_{OP}	0	+50	°C	Note 1
Storage Temperature	T_{ST}	-20	+60	°C	
Operating Humidity	H_{OP}	10	80	%RH	
Storage Humidity	H_{ST}	5	90	%RH	

Note 1 : Temperature and relative humidity range are shown in the figure below.
Wet bulb temperature should be 39 °C max. and no condensation of water.

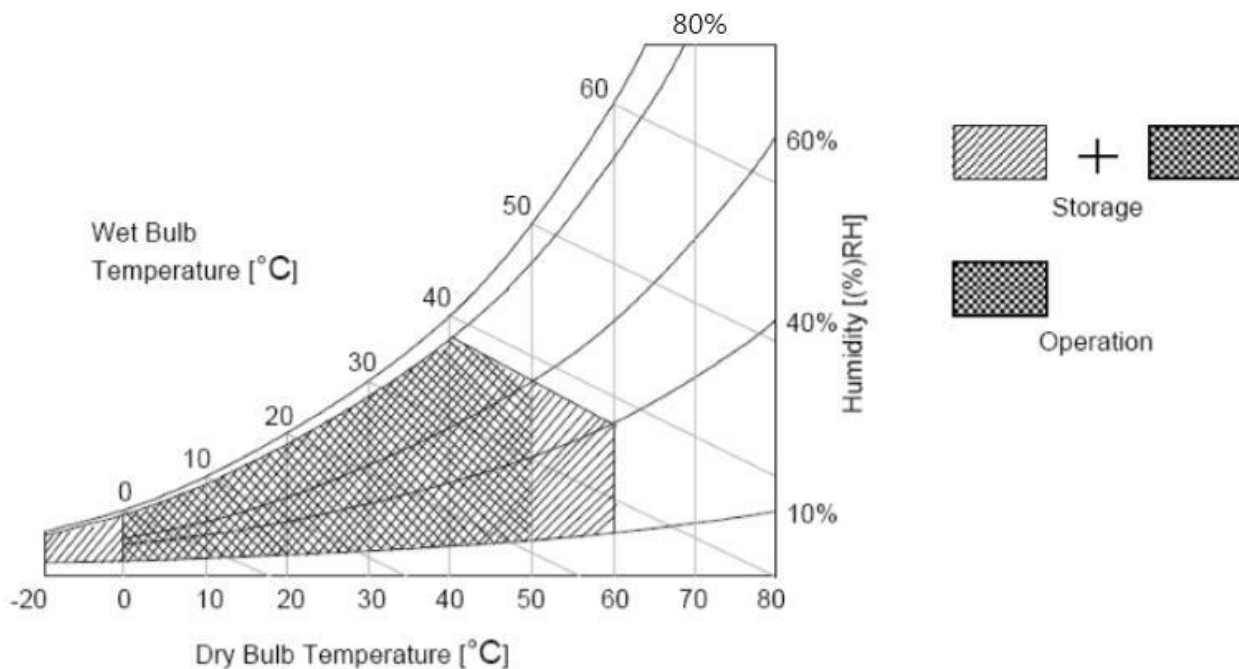

PROPRIETARY NOTE

THIS SPECIFICATION IS THE PROPERTY OF BOE BJ AND SHALL NOT BE REPRODUCED OR COPIED WITHOUT THE WRITTEN PERMISSION OF BOE BJ AND MUST BE RETURNED TO BOE BJ UPON ITS REQUEST

BOE

SPEC. NUMBER
S8-65-8A-292

PRODUCT GROUP
DID

REV.
P0

ISSUE DATE
2019.08.20

PAGE
7 OF 35

3.0 ELECTRICAL SPECIFICATIONS**3.1 Electrical Specifications**

< Table 3. Electrical Specifications >

[Ta =25±2 °C]

Parameter		Symbol	Values			Unit	Remark
			Min	Typ	Max		
Power Supply Input Voltage		VDD	10.8	12	13.2	Vdc	
Power Supply Ripple Voltage		VRP	-	-	300	mV	
Power Supply Current		IDD	-	600	1000	mA	Note 1
Power Consumption		PDD	-	7.2	10	Watt	
Rush current		IRUSH	-	-	5	A	Note 2
LVDS Interface	Differential Input High Threshold Voltage	VLVTH	+100		+600	mV	
	Differential Input Low Threshold Voltage	VLVTL	-600		-100	mV	
	Common Input Voltage	VLVC	1.0	1.2	1.4	V	
T-CON Option Selection Voltage	Input High Threshold Voltage	VIH	2.7	-	3.3	V	
	Input Low Threshold Voltage	VIL	0	-	0.6	V	

Note 1 : The supply voltage is measured and specified at the interface connector of LCM. The current draw and power consumption specified is for VDD=12.0V, Frame rate $f_v=60\text{Hz}$ and Clock frequency = 74.25MHz.

Test Pattern of power supply current

a) Typ : Color Test (L0/L255)

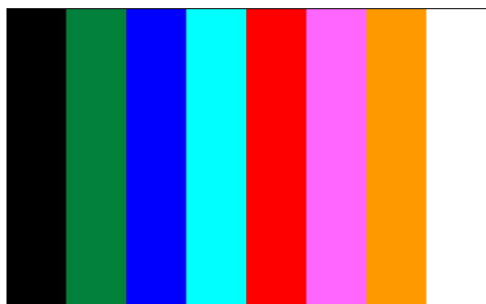

b) Max : Horizontal 1 Line (L0/L255)

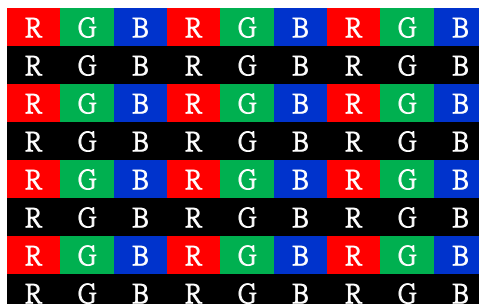

Note 2 : The duration of rush current is about 2ms and rising time of Power Input is 1ms(min)

PROPRIETARY NOTE

THIS SPECIFICATION IS THE PROPERTY OF BOE BJ AND SHALL NOT BE REPRODUCED OR COPIED WITHOUT THE WRITTEN PERMISSION OF BOE BJ AND MUST BE RETURNED TO BOE BJ UPON ITS REQUEST



SPEC. NUMBER
S8-65-8A-292

PRODUCT GROUP
DID

REV.
P0

ISSUE DATE
2019.08.20

PAGE
8 OF 35

3.2 Converter Electrical Specifications

< Table 4. Converter Electrical Specifications >

[Ta =25±2 °C]

Parameter	Symbol	Values			Unit	Remark
		Min	Typ	Max		
Power Supply Input Voltage	VDD	21.6	24	26.4	Vdc	
Power Supply Ripple Voltage	VRP	-	-	400	mV	
Power Supply Current	IDD	-	8.1	10	A	
Power Consumption	PDD	-	195	210	Watt	PWM Duty =100%
Backlight On/Off Control Voltage	V _{B_LON} (off)	0	-	0.3	V	
	V _{B_LON} (on)	2.4	3.3	3.6	V	
Backlight PWM	High Level	2.4	3.3	3.6	V	On duty
	Low Level	0	-	0.3	V	Off duty
	Dimming Ratio	1	-	100	%	Note 1
	PWM Frequency	100	-	300	Hz	
Light Bar Forward Voltage	V _{F_Light Bar}	9.6	-	13.6	V	
LED Forward Current	I _F	-	190	-	mA	
LED Life Time	-	50000	-	-	Hrs	Note 2

Note 1 :Ext_PWM Signal have to input available duty range. Between 99% and 100% ExtVBR-B duty have to be avoided. (99% < ExtVBR-B < 100%),But ExtVBR-B 0% and 100% is possible.

Note 2 : The duration of rush current is about 2ms and rising time of Power Input is 1ms(min)

PROPRIETARY NOTE

THIS SPECIFICATION IS THE PROPERTY OF BOE BJ AND SHALL NOT BE REPRODUCED OR COPIED WITHOUT THE WRITTEN PERMISSION OF BOE BJ AND MUST BE RETURNED TO BOE BJ UPON ITS REQUEST



SPEC. NUMBER

PRODUCT GROUP

REV.

ISSUE DATE

PAGE

S8-65-8A-292

DID

P0

2019.08.20

9 OF 35

4.0 INTERFACE CONNECTION**4.1 Module Input Signal & Power**

- Connector : IS050-C51B-C39-S (UJU) / FI-RE51S-HF-R1500 (JAE) or Equivalent.

< Table 5. Input Connector Pin Configuration >

Pin No	Symbol	Description	Pin No	Symbol	Description
1	VCC	Input Voltage	20	CH1[3]-	First LVDS data input Pair3 -
2	VCC	Input Voltage	21	CH1[3]+	First LVDS data input Pair3 +
3	VCC	Input Voltage	22	NC	Not Connected (1)
4	VCC	Input Voltage	23	NC	Not Connected (1)
5	VCC	Input Voltage	24	GND	Ground
6	NC	Not Connected	25	CH2[0]-	Second LVDS data input Pair0 -
7	GND	Ground	26	CH2[0]+	Second LVDS data input Pair0 +
8	GND	Ground	27	CH2[1]-	Second LVDS data input Pair1 -
9	GND	Ground	28	CH2[1]+	Second LVDS data input Pair1 +
10	CH1[0]-	First LVDS data input Pair0 -	29	CH2[2]-	Second LVDS data input Pair2 -
11	CH1[0]+	First LVDS data input Pair0 +	30	CH2[2]+	Second LVDS data input Pair2 +
12	CH1[1]-	First LVDS data input Pair1 -	31	GND	Ground
13	CH1[1]+	First LVDS data input Pair1 +	32	CH2CLK-	Second LVDS clock input -
14	CH1[2]-	First LVDS data input Pair2 -	33	CH2CLK+	Second LVDS clock input +
15	CH1[2]+	First LVDS data input Pair2 +	34	GND	Ground
16	GND	Ground	35	CH2[3]-	Second LVDS data input Pair3 -
17	CH1CLK-	First LVDS clock input -	36	CH2[3]+	Second LVDS data input Pair3 +
18	CH1CLK+	First LVDS clock input +	37	NC	Not Connected (1)
19	GND	Ground	38	NC	Not Connected (1)

PROPRIETARY NOTE

THIS SPECIFICATION IS THE PROPERTY OF BOE BJ AND SHALL NOT BE REPRODUCED OR COPIED WITHOUT THE WRITTEN PERMISSION OF BOE BJ AND MUST BE RETURNED TO BOE BJ UPON ITS REQUEST



SPEC. NUMBER
S8-65-8A-292

PRODUCT GROUP
DID

REV.
P0

ISSUE DATE
2019.08.20

PAGE
10 OF 35

Pin No	Symbol	Description	Pin No	Symbol	Description
39	GND	Ground	46	NC	Not Connected (1)
40	NC	Not Connected (1)	47	NC	Not Connected (1)
41	Local_ON	High : Local dimming ON Low : Local dimming OFF	48	NC	Not Connected (1)
42	NC	Not Connected (1)	49	NC	Not Connected (1)
43	NC	Not Connected (1)	50	NC	Not Connected (1)
44	NC	Not Connected (1)	51	NC	Not Connected (1)
45	SELLVDS	High : VESA Low or Open: JEIDA			

Notes : 1. NC(Not Connected) : This pins are only used for BOE internal operations.

2. Input Level of LVDS signal is based on the IEA 664 Standard.

3. Pin 41 Local dimming : This pin is used for selecting Local dimming ON or OFF.

If this Pin : High (3.3V) → Local dimming ON

Otherwise : Low (GND) → : Local dimming OFF

4. Pin 45 SELLVDS : This pin is used for selecting LVDS signal data format.

If this Pin : High (3.3V) →VESA LVDS format

Otherwise : Low (GND) or Open(NC) → JEIDA LVDS format

Rear view of LCM

IS050-C51B-C39-S (UJU)

/FI-RE51S-HF-R1500 (JAE)

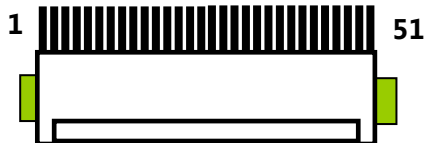

PROPRIETARY NOTE

THIS SPECIFICATION IS THE PROPERTY OF BOE BJ AND SHALL NOT BE REPRODUCED OR COPIED WITHOUT THE WRITTEN PERMISSION OF BOE BJ AND MUST BE RETURNED TO BOE BJ UPON ITS REQUEST



SPEC. NUMBER

PRODUCT GROUP

REV.

ISSUE DATE

PAGE

S8-65-8A-292

DID

P0

2019.08.20

11 OF 35

4.2 BLU Input Signal & Power

-Connector : 22022WR-H14B2 (Manufactured by Yeonho) .

-Mating Connector: 20022HS-14 (or Equivalent)

< Table 6. Input Connector Pin Configuration for Master Board >

Pin No	Symbol	Description	Pin No	Symbol	Description
1	VIN	Operating Voltage Supply, +24V DC regulated	8	GND	Ground and Current Return
2	VIN	Operating Voltage Supply, +24V DC regulated	9	GND	Ground and Current Return
3	VIN	Operating Voltage Supply, +24V DC regulated	10	GND	Ground and Current Return
4	VIN	Operating Voltage Supply, +24V DC regulated	11	NC	No Connection
5	VIN	Operating Voltage Supply, +24V DC regulated	12	BLON	BLU On-Off control: DC 0 to 0.3V off , DC 2.4 to 3.6V On
6	GND	Ground and Current Return	13	PWM	1%≤Duty≤100%
7	GND	Ground and Current Return	14	NC	No Connection

PROPRIETARY NOTE

THIS SPECIFICATION IS THE PROPERTY OF BOE BJ AND SHALL NOT BE REPRODUCED OR COPIED WITHOUT THE WRITTEN PERMISSION OF BOE BJ AND MUST BE RETURNED TO BOE BJ UPON ITS REQUEST



SPEC. NUMBER

PRODUCT GROUP

REV.

ISSUE DATE

PAGE

S8-65-8A-292

DID

P0

2019.08.20

12 OF 35

-Connector : 22022WR-H14B2 (Manufactured by Yeonho) .

-Mating Connector: 20022HS-14 (or Equivalent)

< Table 7. Input Connector Pin Configuration for Slave Board >

Pin No	Symbol	Description	Pin No	Symbol	Description
1	VIN	Operating Voltage Supply, +24V DC regulated	8	GND	Ground and Current Return
2	VIN	Operating Voltage Supply, +24V DC regulated	9	GND	Ground and Current Return
3	VIN	Operating Voltage Supply, +24V DC regulated	10	GND	Ground and Current Return
4	VIN	Operating Voltage Supply, +24V DC regulated	11	NC	No Connection
5	VIN	Operating Voltage Supply, +24V DC regulated	12	NC	No Connection
6	GND	Ground and Current Return	13	NC	No Connection
7	GND	Ground and Current Return	14	NC	No Connection

PROPRIETARY NOTE

THIS SPECIFICATION IS THE PROPERTY OF BOE BJ AND SHALL NOT BE REPRODUCED OR COPIED WITHOUT THE WRITTEN PERMISSION OF BOE BJ AND MUST BE RETURNED TO BOE BJ UPON ITS REQUEST



SPEC. NUMBER

PRODUCT GROUP

REV.

ISSUE DATE

PAGE

S8-65-8A-292

DID

P0

2019.08.20

13 OF 35

4.3 LVDS Interface

- LVDS Receiver : Timing Controller (LVDS Rx merged) / LVDS Data : Pixel Data
< Table 8. Input Connector Pin Configuration >

Channel No.	Data No.	8-bit LVDS Type	
		VESA	JEIDA
0	Bit-0	R0	R2
	Bit-1	R1	R3
	Bit-2	R2	R4
	Bit-3	R3	R5
	Bit-4	R4	R6
	Bit-5	R5	R7
	Bit-6	G0	G2
1	Bit-0	G1	G3
	Bit-1	G2	G4
	Bit-2	G3	G5
	Bit-3	G4	G6
	Bit-4	G5	G7
	Bit-5	B0	B2
	Bit-6	B1	B3
2	Bit-0	B2	B4
	Bit-1	B3	B5
	Bit-2	B4	B6
	Bit-3	B5	B7
	Bit-4	HS	HS
	Bit-5	VS	VS
	Bit-6	DE	DE
3	Bit-0	R6	R0
	Bit-1	R7	R1
	Bit-2	G6	G0
	Bit-3	G7	G1
	Bit-4	B6	B0
	Bit-5	B7	B1
	Bit-6	-	

PROPRIETARY NOTE

THIS SPECIFICATION IS THE PROPERTY OF BOE BJ AND SHALL NOT BE REPRODUCED OR COPIED WITHOUT THE WRITTEN PERMISSION OF BOE BJ AND MUST BE RETURNED TO BOE BJ UPON ITS REQUEST

BOE

SPEC. NUMBER

PRODUCT GROUP

REV.

ISSUE DATE

PAGE

S8-65-8A-292

DID

P0

2019.08.20

14 OF 35

5.0 SIGNAL TIMING SPECIFICATION**5.1 Timing Parameters (DE only mode)**

< Table 9. Timing Table >

Item		Symbols	Min	Typ	Max	Unit	Notes
Horizontal	Display Period	t _{HV}	960	960	960	t _{CLK}	1920/2
	Blank	t _{HB}	90	140	190	t _{CLK}	1
	Total	t _{HP}	1050	1100	1150	t _{CLK}	
Vertical	Display Period	t _V	1080	1080	1080	Lines	1
	Blank	t _{VB}	20	45	69	Lines	
	Total	t _{VP}	1100	1125	1149	Lines	

Item		Symbols	Min	Typ	Max	Unit	Notes
Frequency	DCLK	f _{CLK}	66.00	74.25	82	MHz	1920/2
	Horizontal	f _H	62.7	67.5	72.3	KHz	2
	Total	f _V	57	60	63	Hz	2

- Notes:
1. The input of HSYNC & VSYNC signal does not have an effect on normal operation (DE Only Mode).If you use spread spectrum of EMI, add some additional clock to minimum value for clock margin.
 2. The performance of the electro-optical characteristics may be influenced by variance of the vertical refresh rate and the horizontal frequency.
 3. LVDS Receiver Spread spectrum Clock is defined as below figure.

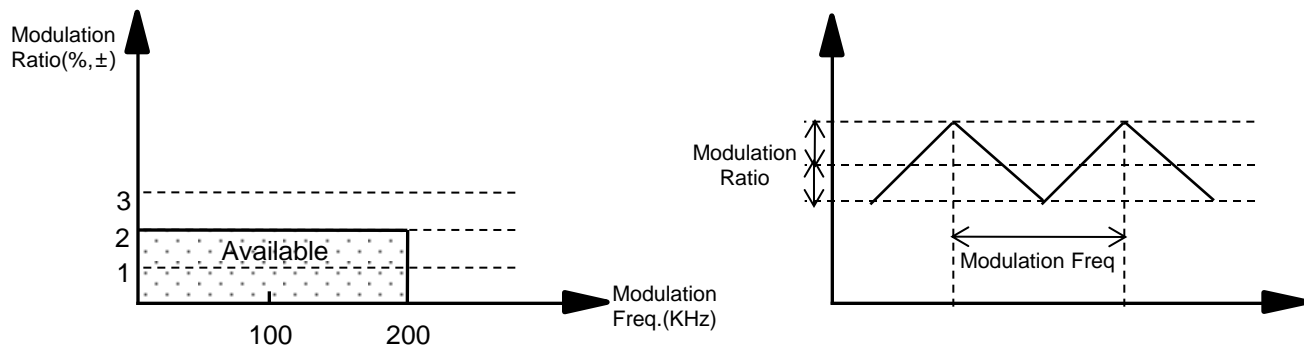

PROPRIETARY NOTE

THIS SPECIFICATION IS THE PROPERTY OF BOE BJ AND SHALL NOT BE REPRODUCED OR COPIED WITHOUT THE WRITTEN PERMISSION OF BOE BJ AND MUST BE RETURNED TO BOE BJ UPON ITS REQUEST



SPEC. NUMBER

PRODUCT GROUP

REV.

ISSUE DATE

PAGE

S8-65-8A-292

DID

P0

2019.08.20

15 OF 35

Please pay attention to the followings when you set Spread Spectrum Rate(SSR) and Modulation Frequency(FMOD)

- 1.Please set proper Spread Spectrum Rate(SSR) and Modulation Frequency (FMOD) of TV system LVDS output.
- 2.Please check FOS after you set Spread Spectrum Rate(SSR) and Modulation Frequency(FMOD) to avoid abnormal display. Especially, harmonic noise can appear when you use Spread Spectrum under FMOD 30 KHz.

5.2 Signal Timing Waveform

5.2.1 LVDS Input Signal Timing Diagram

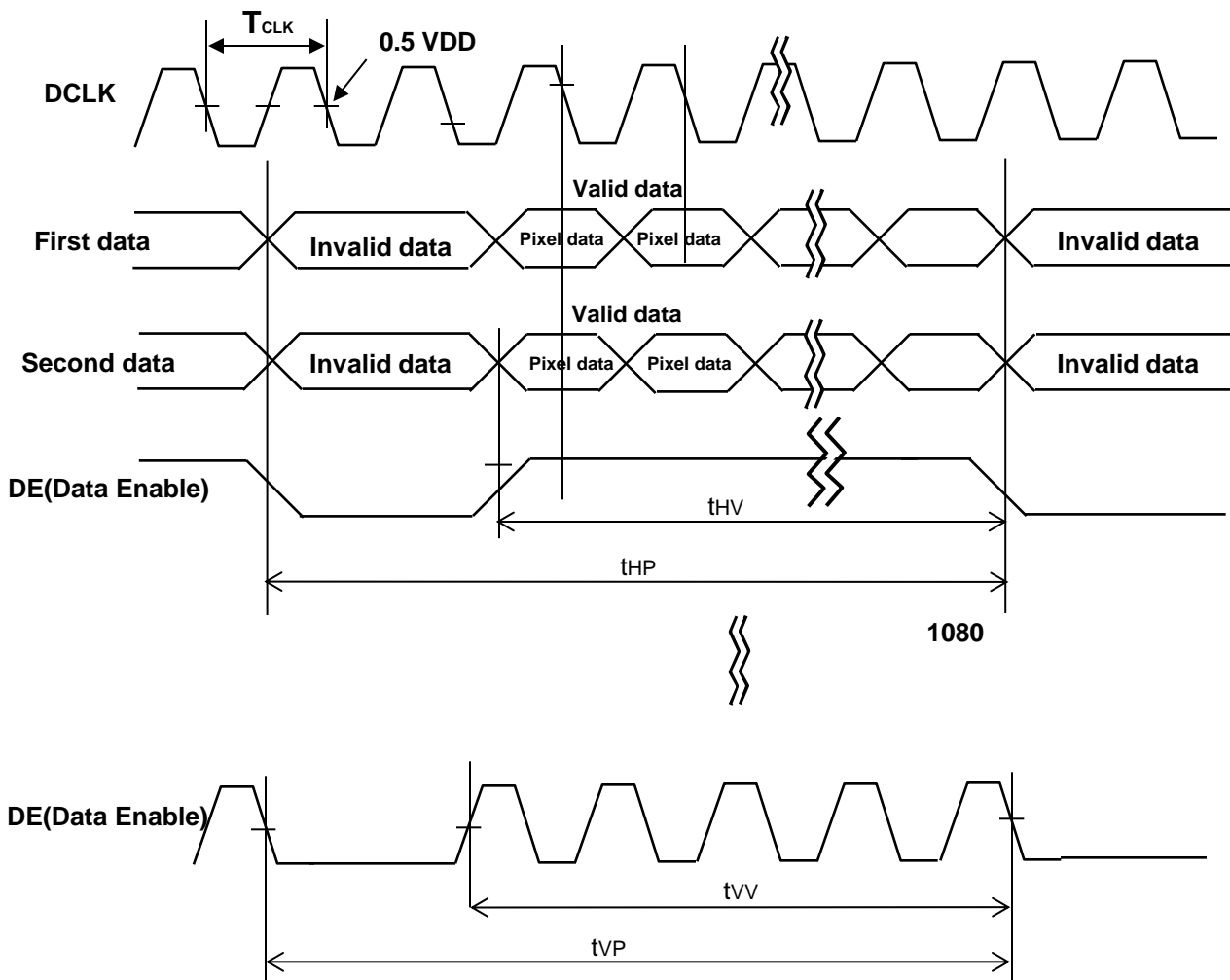

PROPRIETARY NOTE

THIS SPECIFICATION IS THE PROPERTY OF BOE BJ AND SHALL NOT BE REPRODUCED OR COPIED WITHOUT THE WRITTEN PERMISSION OF BOE BJ AND MUST BE RETURNED TO BOE BJ UPON ITS REQUEST



SPEC. NUMBER S8-65-8A-292	PRODUCT GROUP DID	REV. P0	ISSUE DATE 2019.08.20	PAGE 16 OF 35
------------------------------	----------------------	------------	--------------------------	------------------

5.2.2 LVDS Input Signal Characteristics

1) DC Specification

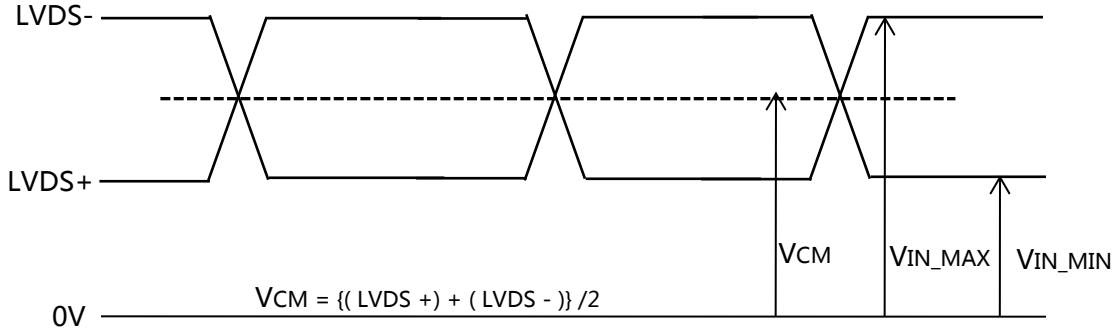

Description	Symbols	Min	Max	Unit
LVDS Common mode Voltage	VCM	1.0	1.4	V
LVDS Input Voltage Range	VIN	0.7	1.7	V
Change in common mode Voltage	ΔV_{CM}	-	200	mV

2) AC Specification

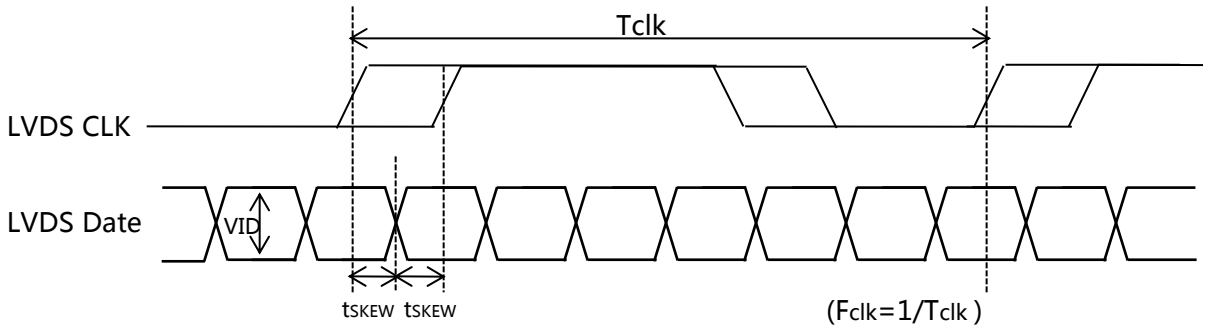

Description	Symbols	Min	Max	Unit	Notes
LVDS Differential Voltage	$ V_{ID} $	100	600	mV	Tested with Differential Probe
LVDS Clock to Data Skew	tsKEW	-	400	ps	
LVDS Clock to Clock Skew (Even to Odd)	tsKEW_EO	-	400	ps	

PROPRIETARY NOTE

THIS SPECIFICATION IS THE PROPERTY OF BOE BJ AND SHALL NOT BE REPRODUCED OR COPIED WITHOUT THE WRITTEN PERMISSION OF BOE BJ AND MUST BE RETURNED TO BOE BJ UPON ITS REQUEST



SPEC. NUMBER
S8-65-8A-292

PRODUCT GROUP
DID

REV.
P0

ISSUE DATE
2019.08.20

PAGE
17 OF 35

5.3 Input Signals, Basic Display Colors and Gray Scale of Colors

< Table 10. Input Signal and Display Color Table >

Color & Gray Scale		Input Data Signal																							
		Red Data						Green Data						Blue Data											
		R7	R6	R5	R4	R3	R2	R1	R0	G7	G6	G5	G4	G3	G2	G1	G0	B7	B6	B5	B4	B3	B2	B1	B0
Basic Colors	Black	0	0	0	0	0	0	0	0	0	0	0	0	0	0	0	0	0	0	0	0	0	0	0	0
	Blue	0	0	0	0	0	0	0	0	0	0	0	0	0	0	0	0	1	1	1	1	1	1	1	1
	Green	0	0	0	0	0	0	0	0	1	1	1	1	1	1	1	1	0	0	0	0	0	0	0	0
	Cyan	0	0	0	0	0	0	0	0	1	1	1	1	1	1	1	1	1	1	1	1	1	1	1	1
	Red	1	1	1	1	1	1	1	1	0	0	0	0	0	0	0	0	0	0	0	0	0	0	0	0
	Magenta	1	1	1	1	1	1	1	1	0	0	0	0	0	0	0	0	1	1	1	1	1	1	1	1
	Yellow	1	1	1	1	1	1	1	1	1	1	1	1	1	1	1	1	0	0	0	0	0	0	0	0
White	1	1	1	1	1	1	1	1	1	1	1	1	1	1	1	1	1	1	1	1	1	1	1	1	
Gray Scale of Red	Black	0	0	0	0	0	0	0	0	0	0	0	0	0	0	0	0	0	0	0	0	0	0	0	
	△	0	0	0	0	0	0	0	1	0	0	0	0	0	0	0	0	0	0	0	0	0	0	0	
	Darker	0	0	0	0	0	0	1	0	0	0	0	0	0	0	0	0	0	0	0	0	0	0	0	
	△																								
	▽																								
	Brighter	1	1	1	1	1	1	0	1	0	0	0	0	0	0	0	0	0	0	0	0	0	0	0	
	▽	1	1	1	1	1	1	1	0	0	0	0	0	0	0	0	0	0	0	0	0	0	0	0	
Red	1	1	1	1	1	1	1	1	0	0	0	0	0	0	0	0	0	0	0	0	0	0	0	0	
Gray Scale of Green	Black	0	0	0	0	0	0	0	0	0	0	0	0	0	0	0	0	0	0	0	0	0	0	0	
	△	0	0	0	0	0	0	0	0	0	0	0	0	0	0	0	1	0	0	0	0	0	0	0	
	Darker	0	0	0	0	0	0	0	0	0	0	0	0	0	0	1	0	0	0	0	0	0	0	0	
	△																								
	▽																								
	Brighter	0	0	0	0	0	0	0	0	1	1	1	1	1	1	0	1	0	0	0	0	0	0	0	
	▽	0	0	0	0	0	0	0	0	1	1	1	1	1	1	0	0	0	0	0	0	0	0	0	
Green	0	0	0	0	0	0	0	0	1	1	1	1	1	1	1	0	0	0	0	0	0	0	0		
Gray Scale of Blue	Black	0	0	0	0	0	0	0	0	0	0	0	0	0	0	0	0	0	0	0	0	0	0	0	
	△	0	0	0	0	0	0	0	0	0	0	0	0	0	0	0	0	0	0	0	0	0	0	1	
	Darker	0	0	0	0	0	0	0	0	0	0	0	0	0	0	0	0	0	0	0	0	0	0	1	
	△																								
	▽																								
	Brighter	0	0	0	0	0	0	0	0	0	0	0	0	0	0	0	1	1	1	1	1	1	1	0	
	▽	0	0	0	0	0	0	0	0	0	0	0	0	0	0	0	1	1	1	1	1	1	1	0	
Blue	0	0	0	0	0	0	0	0	0	0	0	0	0	0	0	1	1	1	1	1	1	1	1		
Gray Scale of White	Black	0	0	0	0	0	0	0	0	0	0	0	0	0	0	0	0	0	0	0	0	0	0	0	
	△	0	0	0	0	0	0	1	0	0	0	0	0	0	0	1	0	0	0	0	0	0	0	1	
	Darker	0	0	0	0	0	0	1	0	0	0	0	0	0	1	0	0	0	0	0	0	0	1	0	
	△																								
	▽																								
	Brighter	1	1	1	1	1	1	0	1	1	1	1	1	1	0	1	1	1	1	1	1	1	0	1	
	▽	1	1	1	1	1	1	1	0	1	1	1	1	1	1	0	1	1	1	1	1	1	1	0	
White	1	1	1	1	1	1	1	1	1	1	1	1	1	1	1	1	1	1	1	1	1	1	1		

PROPRIETARY NOTE

THIS SPECIFICATION IS THE PROPERTY OF BOE BJ AND SHALL NOT BE REPRODUCED OR COPIED WITHOUT THE WRITTEN PERMISSION OF BOE BJ AND MUST BE RETURNED TO BOE BJ UPON ITS REQUEST

BOE

SPEC. NUMBER

PRODUCT GROUP

REV.

ISSUE DATE

PAGE

S8-65-8A-292

DID

P0

2019.08.20

18 OF 35

5.4 Power Sequence

5.4.1 LCD driver circuit

To prevent a latch-up or DC operation of the LCD module, the power on/off sequence shall be as shown in below

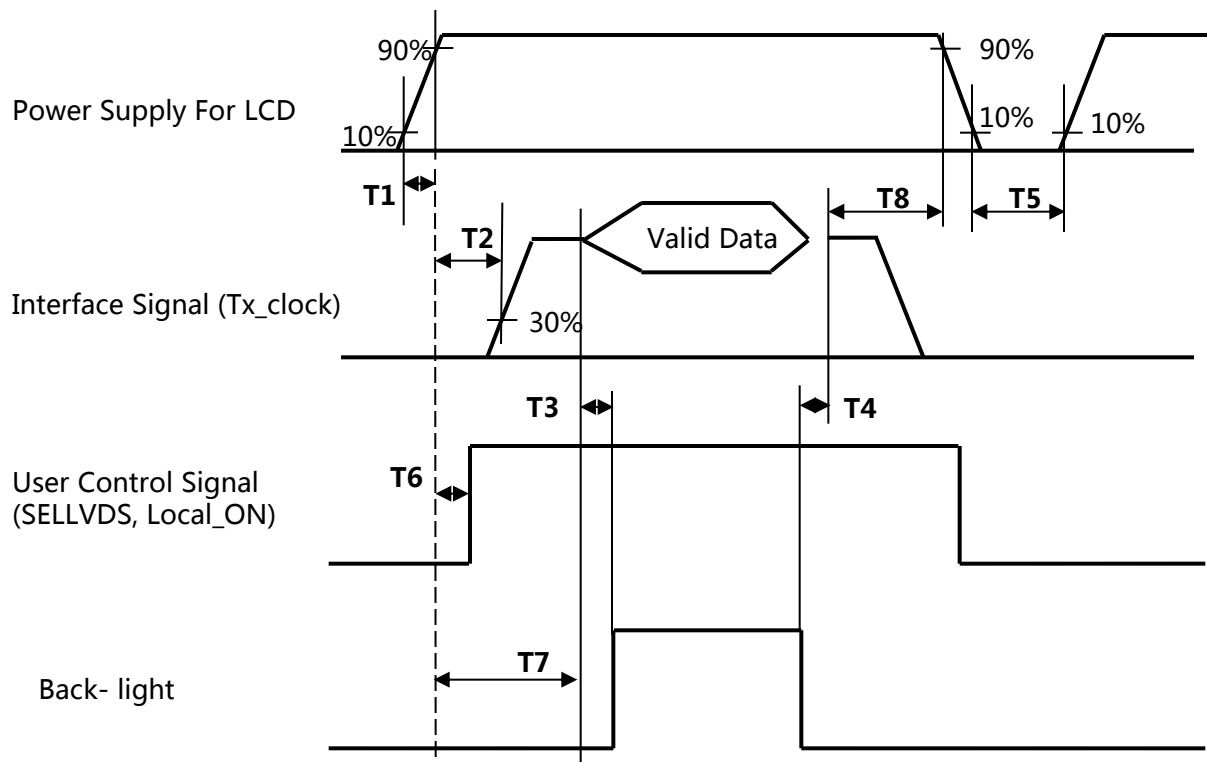

- $10\text{ms} \geq T1 \geq 0.5\text{ms}$
- $T7 \geq T2 \geq 0.1\text{ms}$
- $T3 \geq 400\text{ms}$
- $T4 \geq 200\text{ms}$
- $T5 \geq 5 \text{ sec}$
- $T2 \geq T6 \geq 0.1\text{ms}$
- $T7 \geq 1 \text{ sec}$
- $T8 \geq 100 \text{ ms}$

Notes:

1. When the power supply VDD is 0V, keep the level of input signals on the low or keep high impedance.
2. Do not keep the interface signal high impedance when power is on.
3. Back-light must be turn on after power for logic and interface signal are valid.

PROPRIETARY NOTE

THIS SPECIFICATION IS THE PROPERTY OF BOE BJ AND SHALL NOT BE REPRODUCED OR COPIED WITHOUT THE WRITTEN PERMISSION OF BOE BJ AND MUST BE RETURNED TO BOE BJ UPON ITS REQUEST



SPEC. NUMBER

PRODUCT GROUP

REV.

ISSUE DATE

PAGE

S8-65-8A-292

DID

P0

2019.08.20

19 OF 35

5.4 Power Sequence

5.4.2 Sequence for converter

Power supply for converter

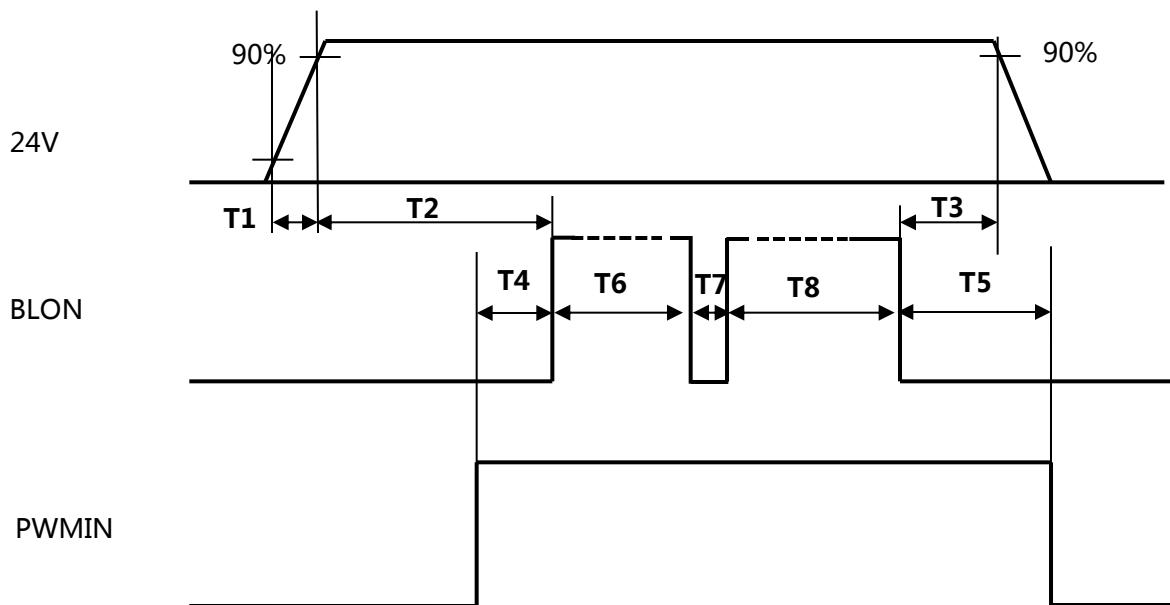

5.4.3 Input Voltage deep condition for converter

$VBL(Typ.) \times 1.1$

$VBL(Typ.) \times 0.9$

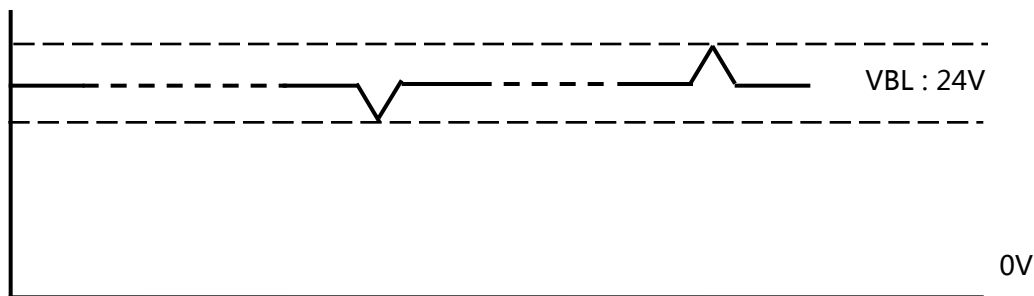

- $T1 / T3 \geq 10ms$
- $T2 \geq 200ms$
- $T4 / T5 \geq 0.1ms$
- $T6 / T8 \geq 2sec$
- $T7 \geq 500ms$

PROPRIETARY NOTE

THIS SPECIFICATION IS THE PROPERTY OF BOE BJ AND SHALL NOT BE REPRODUCED OR COPIED WITHOUT THE WRITTEN PERMISSION OF BOE BJ AND MUST BE RETURNED TO BOE BJ UPON ITS REQUEST



SPEC. NUMBER S8-65-8A-292	PRODUCT GROUP DID	REV. P0	ISSUE DATE 2019.08.20	PAGE 20 OF 35
------------------------------	----------------------	------------	--------------------------	------------------

6.0 OPTICAL SPECIFICATIONS

The test of optical specifications shall be measured in a dark room (ambient luminance ≤ 1 lux and temperature = 25 ± 2 °C) with the equipment of Luminance meter system (Goniometer system and PR730) and test unit shall be located at an approximate distance 50cm from the LCD surface at a viewing angle of θ and Φ equal to 0°. We refer to $\theta_{\Phi=0}$ (= θ_3) as the 3 o' clock direction (the "right"), $\theta_{\Phi=90}$ (= θ_{12}) as the 12 o' clock direction ("upward"), $\theta_{\Phi=180}$ (= θ_9) as the 9 o' clock direction ("left") and $\theta_{\Phi=270}$ (= θ_6) as the 6 o' clock direction ("bottom"). While scanning θ and/or Φ , the center of the measuring spot on the Display surface shall stay fixed. The measurement shall be executed after 30 minutes warm-up period. VDD shall be 12.0V +/-10% at 25°C. Optimum viewing angle direction is 6' clock.

< Table 11. Optical Table >

[VDD = 12.0V, Frame rate = 60Hz, Ta = 25 ± 2 °C]

Parameter		Symbol	Condition	Min	Typ	Max	Unit	Remark
Viewing Angle	Horizontal	Θ_3	CR > 10	-	89	-	Deg.	Note 1
		Θ_9		-	89	-	Deg.	
	Vertical	Θ_{12}		-	89	-	Deg.	
		Θ_6		-	89	-	Deg.	
Contrast ratio	LD ON	DCR	30000	45000:1	-		Note 2	
	LD OFF	CR	900:1	1200:1	-		Note 3	
Reproduction of color	White	W_x	$\Theta = 0^\circ$ (Center) Normal Viewing Angle	TYP. - 0.03	0.280	TYP. + 0.03		Note 4
		W_y			0.290			
	Red	R_x			0.632			
		R_y			0.340			
	Green	G_x			0.310			
		G_y			0.638			
	Blue	B_x			0.151			
		B_y			0.065			
Response Time	G to G	T_g	-	8	10	ms	Note 5	
Gamma Scale				2.0	2.2	2.4		
Brightness				400	500		nit	
Color Temperature					10000		K	
Color Gamut				70	72		%	
Brightness Uniformity		δ_{white}	41point	80	90		%	Note 6

PROPRIETARY NOTE

THIS SPECIFICATION IS THE PROPERTY OF BOE BJ AND SHALL NOT BE REPRODUCED OR COPIED WITHOUT THE WRITTEN PERMISSION OF BOE BJ AND MUST BE RETURNED TO BOE BJ UPON ITS REQUEST



SPEC. NUMBER S8-65-8A-292	PRODUCT GROUP DID	REV. P0	ISSUE DATE 2019.08.20	PAGE 21 OF 35
------------------------------	----------------------	------------	--------------------------	------------------

Note :

- Viewing angle is the angle at which the contrast ratio is greater than 10. The viewing are determined for the horizontal or 3, 9 o' clock direction and the vertical or 6, 12 o' clock direction with respect to the optical axis which is normal to the LCD surface.
- Contrast measurements shall be made at viewing angle of $\theta = 0^\circ$ and at the center of the LCD surface. Luminance shall be measured with all pixels in the view field set first to white, then to the dark (black) state. (See Figure 1 shown in Appendix) Luminance Contrast Ratio (CR) is defined mathematically.

$$CR\&DCR = \frac{\text{Luminance when displaying a white raster}}{\text{Luminance when displaying a black raster}}$$
- LD ON=Local dimming enable; LD OFF=Local dimming disable.
- The color chromaticity coordinates specified in Table 9 shall be calculated from the spectral data measured with all pixels first in red, green, blue and white. Measurements shall be made at the center of the panel.
- Response time is the average time required for display transition by switching the input signal as below table and is based on Frame rate $f_V = 60\text{Hz}$ to optimize. Each time in below table is defined as Figure 2 and shall be measured by switching.

Measured Response Time	Target																
	0	15	31	47	63	79	95	111	127	143	159	175	191	207	223	239	255
0																	
15																	
31																	
47																	
63																	
79																	
95																	
111																	
127																	
143																	
159																	
175																	
191																	
207																	
223																	
239																	
255																	

PROPRIETARY NOTE

THIS SPECIFICATION IS THE PROPERTY OF BOE BJ AND SHALL NOT BE REPRODUCED OR COPIED WITHOUT THE WRITTEN PERMISSION OF BOE BJ AND MUST BE RETURNED TO BOE BJ UPON ITS REQUEST



SPEC. NUMBER

PRODUCT GROUP

REV.

ISSUE DATE

PAGE

S8-65-8A-292

DID

P0

2019.08.20

22 OF 35

6. δ white = Minimum (Lon1,Lon2,..., Lon N) / Maximum (Lon1,Lon2,...,Lon N)*100(%), Where Lon1 to Lon N are the luminance with all pixels displaying white .

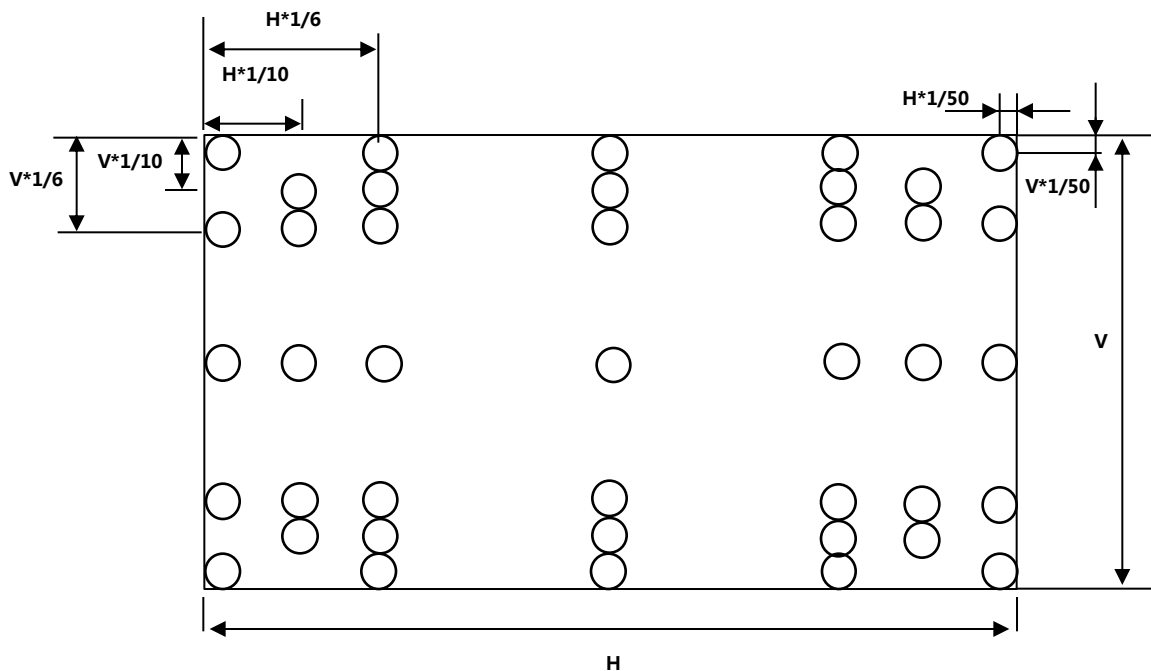

41 points for Brightness measure @ H,V: Active Area

PROPRIETARY NOTE

THIS SPECIFICATION IS THE PROPERTY OF BOE BJ AND SHALL NOT BE REPRODUCED OR COPIED WITHOUT THE WRITTEN PERMISSION OF BOE BJ AND MUST BE RETURNED TO BOE BJ UPON ITS REQUEST



SPEC. NUMBER

PRODUCT GROUP

REV.

ISSUE DATE

PAGE

S8-65-8A-292

DID

P0

2019.08.20

23 OF 35

7.0 MECHANICAL CHARACTERISTICS

7.1 Dimensional Requirements

Figure 3(located in Appendix) shows mechanical outlines for the model DV550FHM-NVD.

Other parameters are shown in Table 12.

< Table 12. Dimensional Parameters >

Parameter	Specification	Unit
Pixel pitch	210(H) ×RGB×630(V)	um
Number of pixels	1920(H) ×1080(V) (1 pixel = R + G + B dots)	pixels
MDL Size	1210.48(H)x 681.28(V)	mm
MDL Thickness	38.3(Body)/46(Mount)	mm
Weight	14600	gram

7.2 Anti-Glare and Polarizer Hardness

The surface of the LCD has an Anti-glare coating to minimize reflection and a coating to Reduce scratching (with front polarizer Haze 25%(typ.).

PROPRIETARY NOTE

THIS SPECIFICATION IS THE PROPERTY OF BOE BJ AND SHALL NOT BE REPRODUCED OR COPIED WITHOUT THE WRITTEN PERMISSION OF BOE BJ AND MUST BE RETURNED TO BOE BJ UPON ITS REQUEST



SPEC. NUMBER

PRODUCT GROUP

REV.

ISSUE DATE

PAGE

S8-65-8A-292

DID

P0

2019.08.20

24 OF 35

8.0 RELIABILITY TEST

The Reliability test items and its conditions are shown in below.

< Table 13. Reliability Test Parameters >

No	Test Items	Conditions
1	High temperature storage test	Ta = 60 °C, 240 hrs
2	Low temperature storage test	Ta = -20 °C, 240 hrs
3	High temperature & high humidity operation test	Ta = 50 °C, 80%RH, 240hrs
4	High temperature operation test	Ta = 50 °C, 240hrs
5	Low temperature operation test	Ta = 0 °C, 240hrs
6	Vibration test (Packing)	Frequency : 5 ~ 200 Hz, Random +Z(MDL Packing method); Gravity : 1.05Grms; Period : 2hrs;
7	Electro-static discharge test	Air : ±15kV ,150pF/330Ω ,100Point ,1time/Point Contact :±8kV ,150pF/330Ω ,100Point ,1time/Point No operation Failure; Pin Contact:±5KV,150pF/330Ω, Input connector Pin, 3 times/pin; No function loss;
8	Altitude storage / shipment	0 - 40,000 ft

PROPRIETARY NOTE

THIS SPECIFICATION IS THE PROPERTY OF BOE BJ AND SHALL NOT BE REPRODUCED OR COPIED WITHOUT THE WRITTEN PERMISSION OF BOE BJ AND MUST BE RETURNED TO BOE BJ UPON ITS REQUEST



SPEC. NUMBER S8-65-8A-292	PRODUCT GROUP DID	REV. P0	ISSUE DATE 2019.08.20	PAGE 25 OF 35
------------------------------	----------------------	------------	--------------------------	------------------

9.0 PRODCUT SERIAL NUMBER

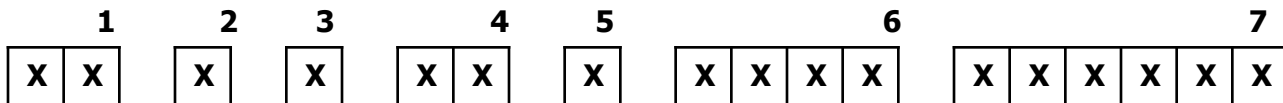

- 1. Control Number
- 2. Rank / Grade
- 3. Line Classification
- 4. Year (2011 : 11, 2012 : 12, ...)
- 5. Month (1,2,3, ... , 9, X, Y, Z)
- 6. Internal Use
- 7. Serial Number

PROPRIETARY NOTE

THIS SPECIFICATION IS THE PROPERTY OF BOE BJ AND SHALL NOT BE REPRODUCED OR COPIED WITHOUT THE WRITTEN PERMISSION OF BOE BJ AND MUST BE RETURNED TO BOE BJ UPON ITS REQUEST



SPEC. NUMBER

PRODUCT GROUP

REV.

ISSUE DATE

PAGE

S8-65-8A-292

DID

P0

2019.08.20

26 OF 35

10.0 PACKING INFORMATION

BOE provides the standard shipping container for customers, unless customer specifies their packing information. The standard packing method and Barcode information are shown in below.

10.1 Packing Order

LCD Module

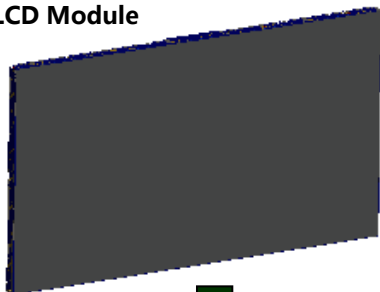

Shielding Bag

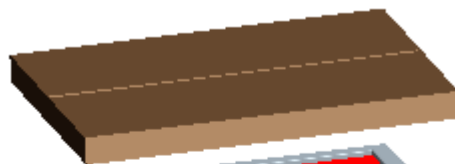
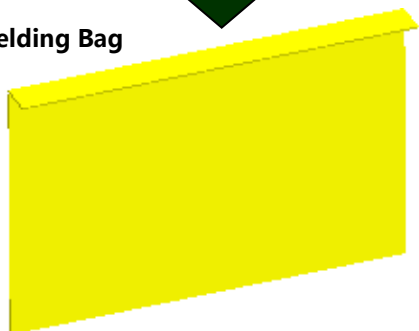

Top-Cover

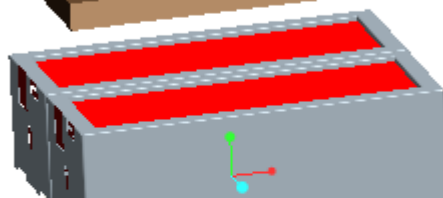

EPS Box

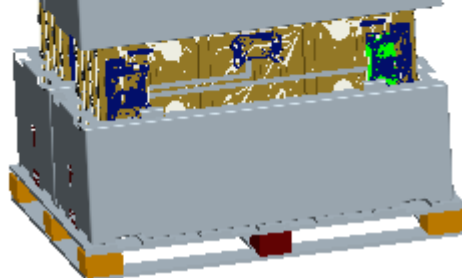

EPS Box



Pallet

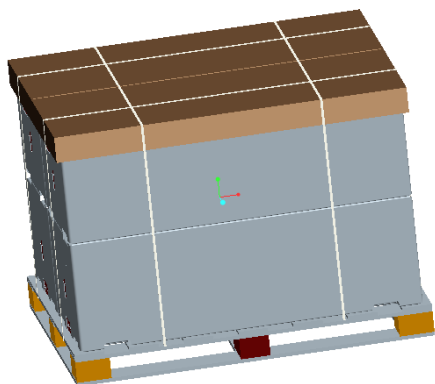

PROPRIETARY NOTE

THIS SPECIFICATION IS THE PROPERTY OF BOE BJ AND SHALL NOT BE REPRODUCED OR COPIED WITHOUT THE WRITTEN PERMISSION OF BOE BJ AND MUST BE RETURNED TO BOE BJ UPON ITS REQUEST



SPEC. NUMBER S8-65-8A-292	PRODUCT GROUP DID	REV. P0	ISSUE DATE 2019.08.20	PAGE 27 OF 35
------------------------------	----------------------	------------	--------------------------	------------------

10.2 Packing Note

- Box Dimension : 1360mm(L)x567mm(W)x884.5mm(H)
- Package Quantity in one Box : 5pcs

10.3 Box Label

- Label Size : 110 mm (L) × 55 mm (W)
- Contents

Model : DV550FHM-NVD

Q`ty : Module 5Q`ty in one box

Serial No. : Box Serial No. See next page for detail description.

Date : Packing Date

FG Code : FG Code of Product

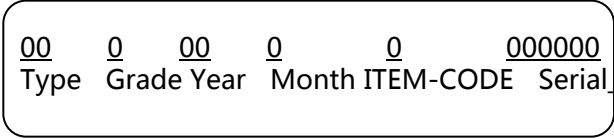
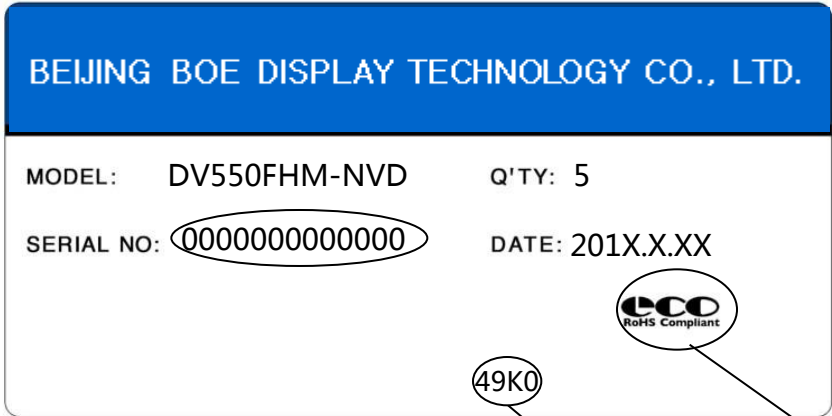

Internal CODE

RoHS Mark

PROPRIETARY NOTE

THIS SPECIFICATION IS THE PROPERTY OF BOE BJ AND SHALL NOT BE REPRODUCED OR COPIED WITHOUT THE WRITTEN PERMISSION OF BOE BJ AND MUST BE RETURNED TO BOE BJ UPON ITS REQUEST



SPEC. NUMBER	PRODUCT GROUP	REV.	ISSUE DATE	PAGE
S8-65-8A-292	DID	P0	2019.08.20	28 OF 35

11.0 PRECAUTIONS

Please pay attention to the followings when you use this TFT LCD Module.

11.1 Mounting Precautions

- Use finger-stalls with soft gloves in order to keep display clean during the incoming inspection and assembly process.
- You must mount a module using specified mounting holes (Details refer to the drawings).
- You should consider the mounting structure so that uneven force (ex. Twisted stress, Concentrated stress) is not applied to the module. And the case on which a module is mounted should have sufficient strength so that external force is not transmitted directly to the module.
- Do not apply mechanical stress or static pressure on module; Abnormal display cause by pressing some parts of module during assembly process, do not belong to product failure, the press should be agreed by two sides.
- Determine the optimum mounting angle, refer to the viewing angle range in the specification for each model.
- You should adopt radiation structure to satisfy the temperature specification.
- Acetic acid type and chlorine type materials for the cover case are not desirable because the former generates corrosive gas of attacking the polarizer at high temperature and the latter causes circuit break by electro-chemical reaction.
- Do not touch, push or rub the exposed polarizers with glass, tweezers or anything harder than HB pencil lead. And please do not rub with dust clothes with chemical treatment.
- Do not touch the surface of polarizer for bare hand or greasy cloth. (Some cosmetics are detrimental to the polarizer.)
- When the surface becomes dusty, please wipe gently with absorbent cotton or other soft materials like chamois soaks with petroleum benzine. Normal-hexane & alcohol is recommended for cleaning the adhesives used to attach front / rear polarizers. Do not use acetone, toluene, because they cause chemical damage to the polarizer.
- Wipe off saliva or water drops as soon as possible. Their long time contact with polarizer causes deformations and color fading.
- Do not apply static pressure on module, and avoid impact, vibration and falling.
- This module has its circuitry PCB's on the rear side and Driver IC, should be handled carefully in order not to be stressed.
- Avoid impose stress on PCB and Driver IC during assembly process, Do not drawing, bending, COF package & wire
- Do not disassemble the module.

PROPRIETARY NOTE

THIS SPECIFICATION IS THE PROPERTY OF BOE BJ AND SHALL NOT BE REPRODUCED OR COPIED WITHOUT THE WRITTEN PERMISSION OF BOE BJ AND MUST BE RETURNED TO BOE BJ UPON ITS REQUEST



SPEC. NUMBER	PRODUCT GROUP	REV.	ISSUE DATE	PAGE
S8-65-8A-292	DID	P0	2019.08.20	29 OF 35

11.2 Operating Precautions

- Do not connector or disconnect the cable to/from the Module at the "Power On" Condition.
- When the module is operating, do not lose CLK, ENAB signals. If any one of these signals is lost, the module would be damaged.
- Obey the supply voltage sequence. If wrong sequence is applied, the module would be damaged.
- The electrochemical reaction caused by DC voltage will lead to LCD module degradation, so DC drive should be avoided.
- The LCD modules use C-MOS LSI drivers, so customers are recommended that any unused input terminal would be connected to Vdd or Vss, do not input any signals before power is turn on, and ground you body, work/assembly area, assembly equipment to protect against static electricity.
- Do not exceed the absolute maximum rating value. (supply voltage variation, input voltage variation, variation in part contents and environmental temperature, and so on) Otherwise the Module may be damaged.
- Module has high frequency circuits. Sufficient suppression to the electromagnetic interference shall be done by system manufacturers. Grounding and shielding methods may be important to minimized the interference.
- Design the length of cable to connect between the connector for back-light and the converter as shorter as possible and the shorter cable shall be connected directly , The long cable between back-light and Converter may cause the Luminance of LED to lower and need a higher startup voltage
- The cables should be as short as possible between System Board and PCB interface.
- Connectors are precision devices to transmit electrical signals, and operators should plug in parallel
- Be careful for condensation at sudden temperature change. Condensation makes damage to polarizer or electrical contacted parts. And after fading condensation, smear or spot will occur.

11.3 Electrostatic Discharge Precautions

- Since a module is composed of electronic circuits, it is not strong to electrostatic discharge. Make certain that treatment persons are connected to ground through wrist band etc.
- Do not touch interface pin directly.

PROPRIETARY NOTE

THIS SPECIFICATION IS THE PROPERTY OF BOE BJ AND SHALL NOT BE REPRODUCED OR COPIED WITHOUT THE WRITTEN PERMISSION OF BOE BJ AND MUST BE RETURNED TO BOE BJ UPON ITS REQUEST



SPEC. NUMBER S8-65-8A-292	PRODUCT GROUP DID	REV. P0	ISSUE DATE 2019.08.20	PAGE 30 OF 35
------------------------------	----------------------	------------	--------------------------	------------------

11.4 Precautions for Strong Light Exposure

- Do not leave the module operation or storage in Strong light . Strong light exposure causes degradation of polarizer and color filter.

11.5 Precautions for Storage

A. Atmosphere Requirement

ITEM	UNIT	MIN	MAX
Storage Temperature	(°C)	5	40
Storage Humidity	(%rH)	35	75
Storage Life	6 months		
Storage Condition	<ul style="list-style-type: none">• The storage room should be equipped with a dark and good ventilation facility.• Prevent products from being exposed to the direct sunlight, moisture and water.• The product need to keep away from organic solvent and corrosive gas.• Be careful for condensation at sudden temperature change.• Storage condition is guaranteed under packing conditions.		

B. Package Requirement

- The product should be placed in a sealed polythene bag.
- Product Should be placed on the pallet, Which is away from the floor, Be cautions not to pile the product up.
- As the original protective film, do not use the adhesive protective film to avoid change of Pol color and characteristic.

11.6 Precautions for protection film

- Remove the protective film slowly, keeping the removing direction approximate 30-degree not vertical from panel surface, If possible, under ESD control device like ion blower, and the humidity of working room should be kept over 50%RH to reduce the risk of static charge.
- People who peeled off the protection film should wear anti-static strap and grounded well.

PROPRIETARY NOTE

THIS SPECIFICATION IS THE PROPERTY OF BOE BJ AND SHALL NOT BE REPRODUCED OR COPIED WITHOUT THE WRITTEN PERMISSION OF BOE BJ AND MUST BE RETURNED TO BOE BJ UPON ITS REQUEST



SPEC. NUMBER	PRODUCT GROUP	REV.	ISSUE DATE	PAGE
S8-65-8A-292	DID	P0	2019.08.20	31 OF 35

11.7 Appropriate Condition for Commercial Display

- Generally large-sized LCD modules are designed for consumer applications . Accordingly, long-term display like in Commercial Display application, can cause uneven display including image sticking. To optimize module's lifetime and function, several operating usages are required.

1. Normal operating condition

- Temperature: $20\pm 15^{\circ}\text{C}$
- Operating Ambient Humidity : $55\pm 20\%$
- Display pattern: dynamic pattern (Real display)

2. Special operating condition

a. Ambient condition

- Well-ventilated place is recommended to set up Commercial Display system.

b. Power and screen save

- Periodical power-off or screen save is needed after long-term display.

c. As the low temperature, the response time is greatly delayed. As the high temperatures (higher than the operating temperature) the LCD module may turn black screen. The above phenomenon cannot explain the failure of the display. When the temperature returns to the normal operating temperature, the LCD module will return to normal display.

d. When expose to drastic fluctuation of temperature (hot to cold or cold to hot) ,the LCD module may be affected; Specifically, drastic temperature fluctuation from cold to hot ,produces dew on the LCD module 's surface which may affect the operation of the polarizer and LCD module

e. Do not exceed the absolute maximum rating value. (supply voltage variation, input voltage variation, variation in part contents and environmental temperature, and so on) Otherwise the Module may be damaged.

f. Product reliability and functions are only guaranteed when the product is used under right operation usages. If product will be used in extreme conditions such as high temperature, high humidity, high altitude, special display images, running time, long time operation, outdoor operation, etc. It is strongly recommended to contact BOE for filed application engineering advice. Otherwise, its reliability and function may not be guaranteed. Extreme conditions are commonly found at airports, transit stations, banks, stock market and controlling systems.

PROPRIETARY NOTE

THIS SPECIFICATION IS THE PROPERTY OF BOE BJ AND SHALL NOT BE REPRODUCED OR COPIED WITHOUT THE WRITTEN PERMISSION OF BOE BJ AND MUST BE RETURNED TO BOE BJ UPON ITS REQUEST



SPEC. NUMBER	PRODUCT GROUP	REV.	ISSUE DATE	PAGE
S8-65-8A-292	DID	P0	2019.08.20	32 OF 35

3. Operating usages to protect against image sticking due to long-term static display.

- a. Suitable operating time: under 24 hours a day.
(The moving picture can be allowed for 24 hours a day)
- b. Static information display recommended to use with moving image.
 - Cycling display between 5 minutes' information(static) display and 10 seconds' moving image.
- c. Background and character (image) color change
 - Use different colors for background and character, respectively.
 - Change colors themselves periodically.
- d. Avoid combination of background and character with large different luminance.
 - Abnormal condition just means conditions except normal condition.
 - Black image or moving image is strongly recommended as a screen save

4. Lifetime in this spec. is guaranteed only when Commercial Display is used according to operating usages.

5. Module should be turned clockwise based on front view when used in portrait mode.

11.8 Other Precautions

A. LC Leak

- If the liquid crystal material leaks from the panel, it is recommended to wash the LC with acetone or ethanol and then burn it.
- In case of contact with hands, skin or clothes, it has to be washed away thoroughly with soap.
- If LC in mouth, mouth need to be washed, drink plenty of water to induce vomiting and follow medical advice.
- If LC touch eyes, eyes need to be washed with running water at least 15 minutes.

B. Rework

- When returning the module for repair or etc., Please pack the module not to be broken. We recommend to use the original shipping packages.

PROPRIETARY NOTE

THIS SPECIFICATION IS THE PROPERTY OF BOE BJ AND SHALL NOT BE REPRODUCED OR COPIED WITHOUT THE WRITTEN PERMISSION OF BOE BJ AND MUST BE RETURNED TO BOE BJ UPON ITS REQUEST



SPEC. NUMBER S8-65-8A-292	PRODUCT GROUP DID	REV. P0	ISSUE DATE 2019.08.20	PAGE 33 OF 35
------------------------------	----------------------	------------	--------------------------	------------------

12.0 APPENDIX

< Figure 1. Measurement Set Up >

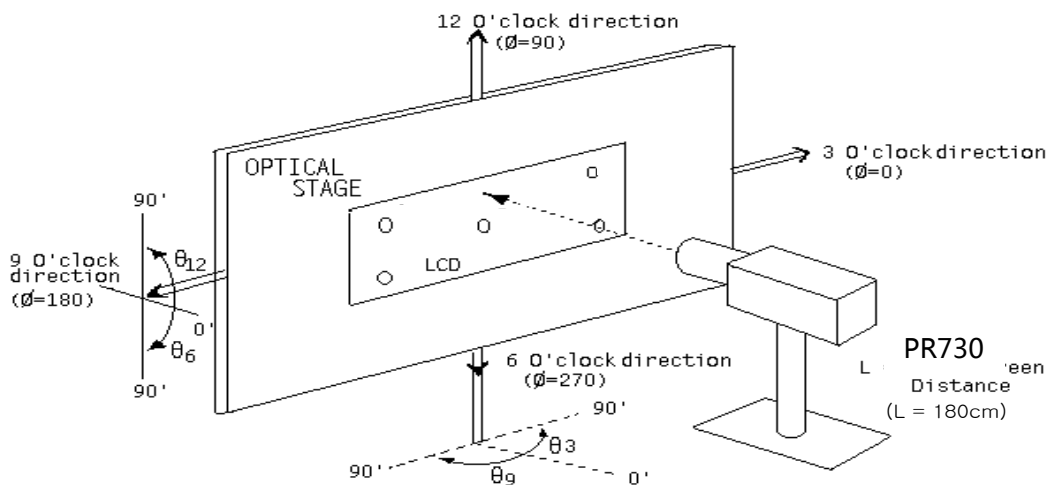

< Figure 2. Response Time Testing >

Any level of gray (Bright) Any level of gray (Dark) Any level of gray (Bright)

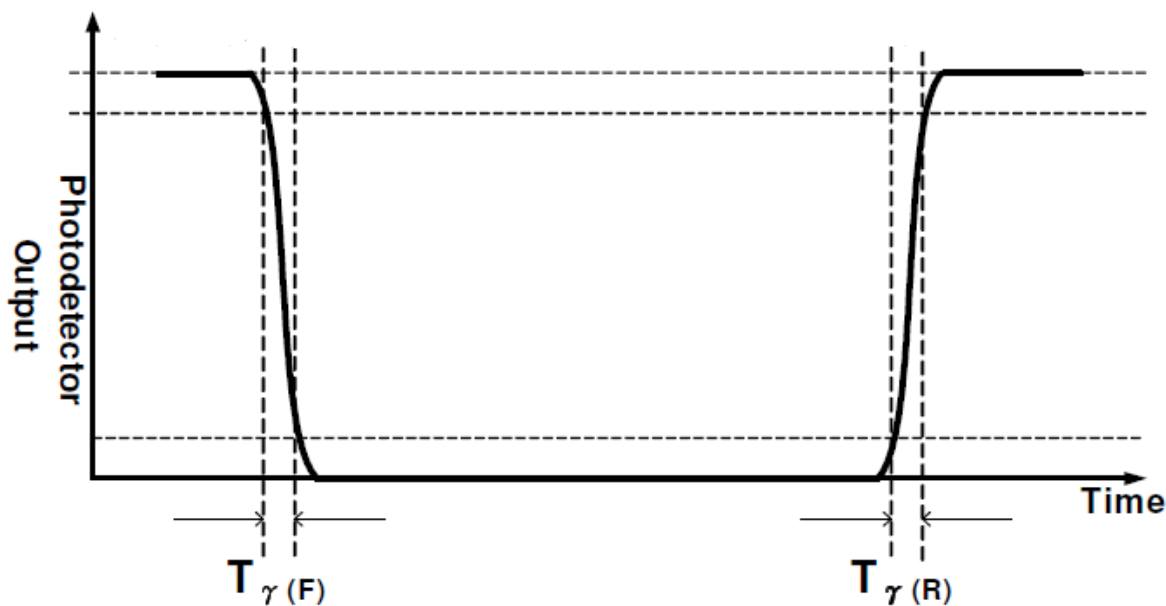

PROPRIETARY NOTE

THIS SPECIFICATION IS THE PROPERTY OF BOE BJ AND SHALL NOT BE REPRODUCED OR COPIED WITHOUT THE WRITTEN PERMISSION OF BOE BJ AND MUST BE RETURNED TO BOE BJ UPON ITS REQUEST



SPEC. NUMBER
S8-65-8A-292

PRODUCT GROUP
DID

REV.
P0

ISSUE DATE
2019.08.20

PAGE
34 OF 35

Figure 3. TFT-LCD Module Outline Dimensions (Front view)

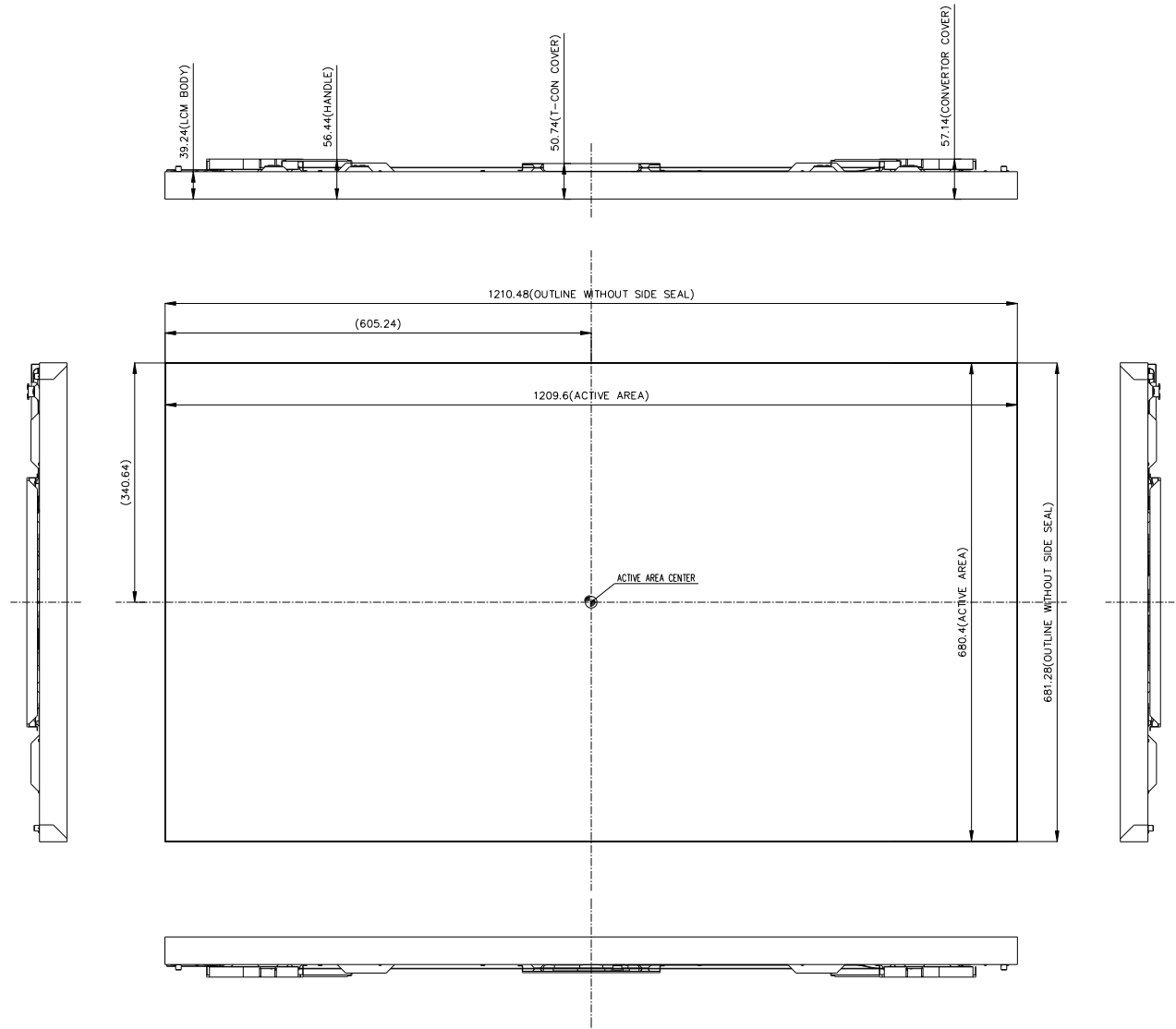

NOTES:
1. UNSPECIFIED DIMENSIONAL TOLERANCES TO BE GRADE 3.
2. MAX TORQUE: REFER TO DETAIL

TOLERANCE TABLE(±)				
DIMENSION	max	min	max	min
1-20	0.05	0.10	0.11	0.20
20-150	0.1	0.15	0.2	0.30
50-150	0.15	0.2	0.25	0.35
150-1500	0.2	0.25	0.3	0.4
150-1500	0.3	0.4	0.5	0.6
150-1500	0.4	0.5	0.6	0.8

UNLESS OTHERWISE SPECIFIED

PROPRIETARY NOTE

THIS SPECIFICATION IS THE PROPERTY OF BOE BJ AND SHALL NOT BE REPRODUCED OR COPIED WITHOUT THE WRITTEN PERMISSION OF BOE BJ AND MUST BE RETURNED TO BOE BJ UPON ITS REQUEST



SPEC. NUMBER
S8-65-8A-292

PRODUCT GROUP
DID

REV.
P0

ISSUE DATE
2019.08.20

PAGE
35 OF 35

Figure 4. TFT-LCD Module Outline Dimensions (Back view)

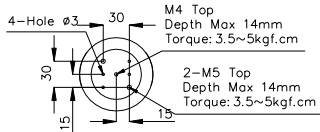
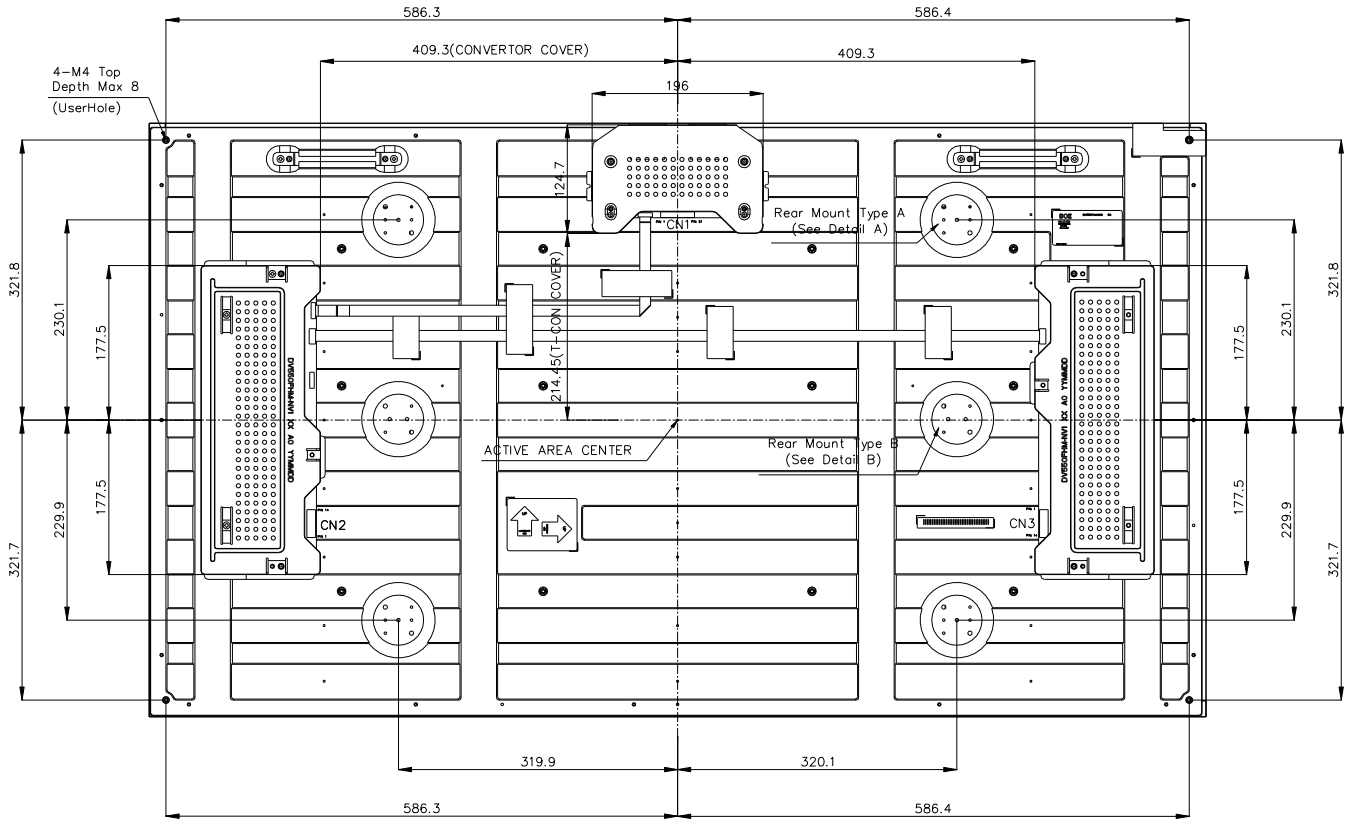

Detail A

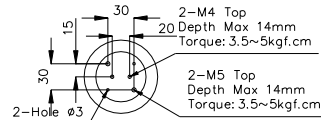

Detail B

NOTES:
1. UNSPECIFIED DIMENSIONAL TOLERANCES TO BE GRADE3.
2. CN1: ISO50-C51B-C39-S CN2~CN3: CIO114M1HR0-NH

TOLERANCE TABLE(±)				
DIMENSION	GRADE 1	GRADE 2	GRADE 3	GRADE 4
L ≤ 20	0.05	0.1	0.1	0.2
20 < L ≤ 50	0.1	0.15	0.2	0.25
50 < L ≤ 100	0.15	0.2	0.25	0.3
100 < L ≤ 200	0.2	0.25	0.3	0.5
200 < L	0.25	0.3	0.5	0.8

UNLESS OTHERWISE SPECIFIED