

3030A06-XXN10-2S-C6-LX Datasheet

This 3030 LED Light Source is a high performance energy efficient device which can handle high thermal and high driving current. The small package outline and high intensity make it an ideal choice for LED panel light, LED bulb light, LED tube light, backlighting and etc.

The White Power LED is available in the range of color temperature from 2600K to 7000K.

This part has a foot print that is compatible to most of the same size LED in the market today.

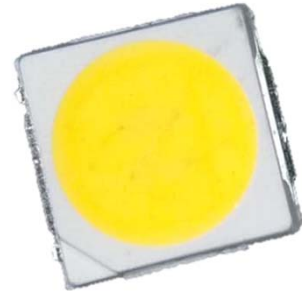

FEATURES

- Available in Cool White, Neutral White and Warm White color
- ANSI-compatible chromaticity bins
- High luminous Intensity and high efficiency
- Compatible with reflow soldering process
- Low thermal resistance
- Long operation life
- Wide viewing angle at 120°
- Silicone encapsulation
- Environmental friendly, RoHS compliance

APPLICATIONS

- Flat panel light
- Backlighting
- LED tube light
- Signage and channel letter
- Reading lamp
- Architectural lighting

Note: The information in this document is subject to change without notice.

PACKAGE DIMENSIONS

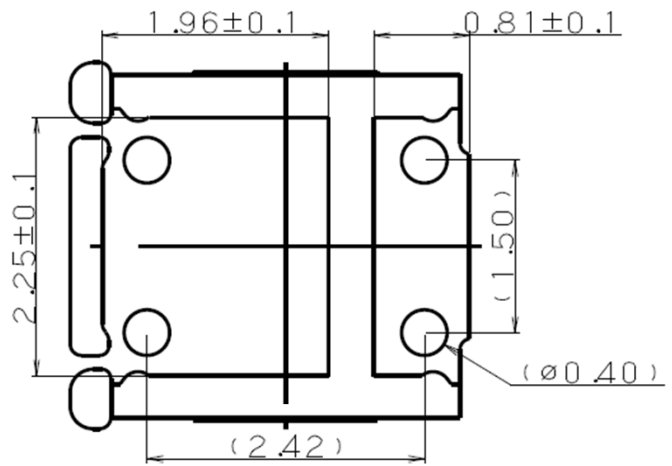
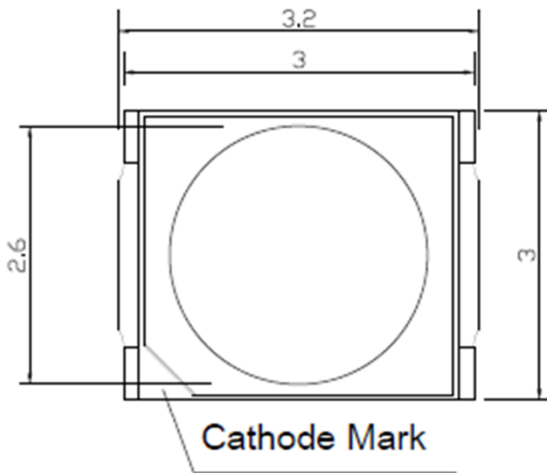

Notes:

1. All dimensions in millimeters.
2. Thickness tolerance of copper plate is $\pm 0.02\text{mm}$.
3. Thickness tolerance of product is $\pm 0.05\text{mm}$.
4. Tolerance is $\pm 0.1\text{mm}$ unless otherwise noted.

ABSOLUTE MAXIMUM RATINGS

Item	Symbol	Absolute Maximum Rating	Unit
Forward current	I_F	200	mA
Peak Forward Current ^[1]	I_{FP}	400	mA
Reverse Voltage	V_R	10	V
Power Dissipation	P_d	1000	mW
Operating Temperature	T_{opr}	-40~+85	°C
Storage Temperature	T_{stg}	-40~+100	°C
Soldering Temperature	T_{sld}	Reflow Soldering: 260°C for 10 seconds	
LED Junction Temperature	T_j	115	°C

Note:

I_{FP} Conditions: Pulse Width ≤ 10 msec. and Duty $\leq 1/10$.

CHARACTERISTICS (T_j=25°C)

Parameter	Symbol	Condition	Min	Typ	Max	Unit
Forward Voltage ^[1]	V_F	$I_F=150$ mA	5.8	6.2	6.6	V
Viewing Angle	$2\theta_{1/2}$	$I_F=150$ mA	--	120	--	deg.
Luminous Flux	Φ_v	$I_F=150$ mA	130	--	160	lm
Color Rendering Index	CRI	$I_F=150$ mA	70	--	--	--
Color Temperature	CCT	$I_F=150$ mA	2600	--	7000	K
Thermal Resistance (Junction to Solder Point)	R_{th-js}	$I_F=150$ mA	--	10	--	°C/W

Notes:

- Luminous flux is measured with an accuracy of $\pm 10\%$.
- Chromaticity coordinate bins are measured with an accuracy of ± 0.01 .
- CRI is measured with an accuracy of ± 2 ;
- Some color and CRI bins may have limited availability, please contact us before ordering.
- All measurements were made under the standardized environment of Shineon

RELATIVE SPECTRAL POWER DISTRIBUTION ($T_j=25^\circ\text{C}$)

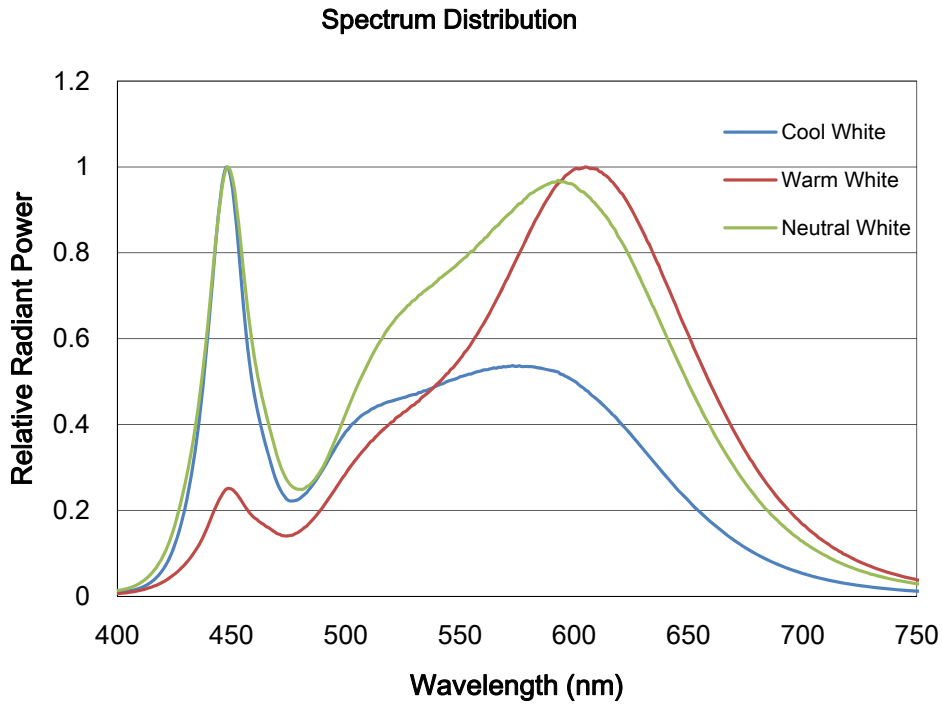

TYPICAL SPATIAL DISTRIBUTION

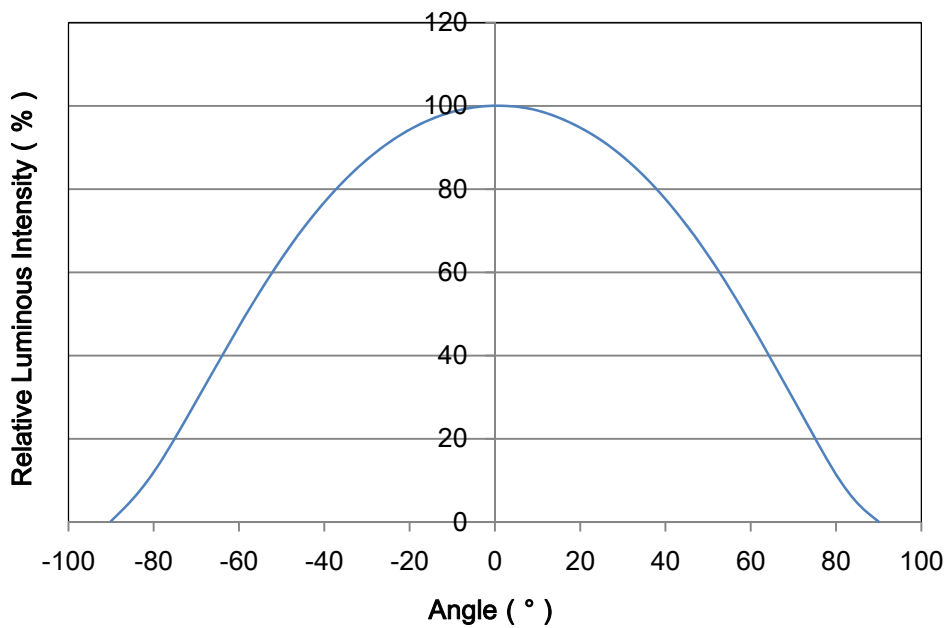

RELATIVE LUMINOUS FLUX VS. CURRENT ($T_j=25^{\circ}\text{C}$)

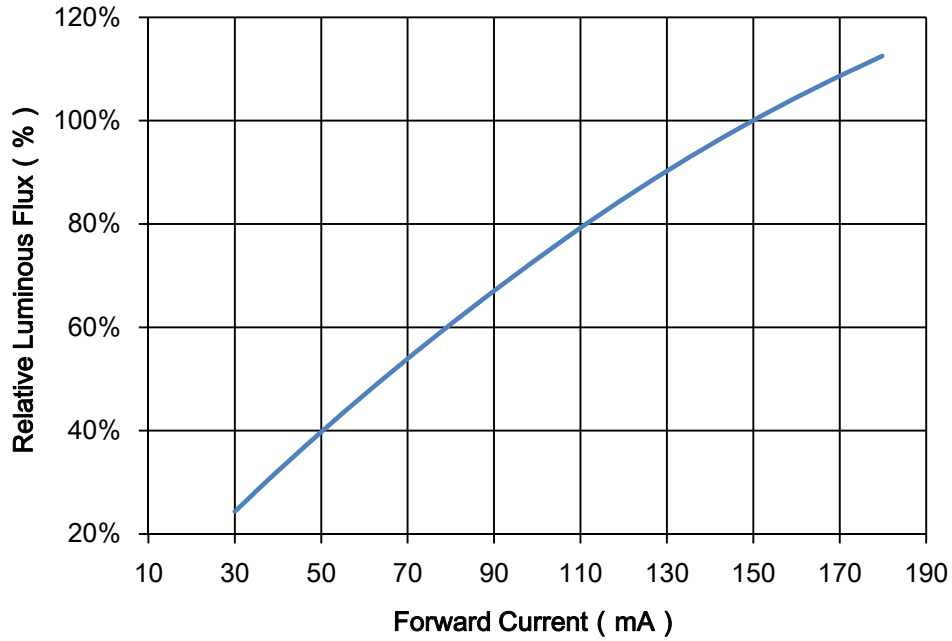

ELECTRICAL CHARACTERISTICS ($T_j=25^{\circ}\text{C}$)

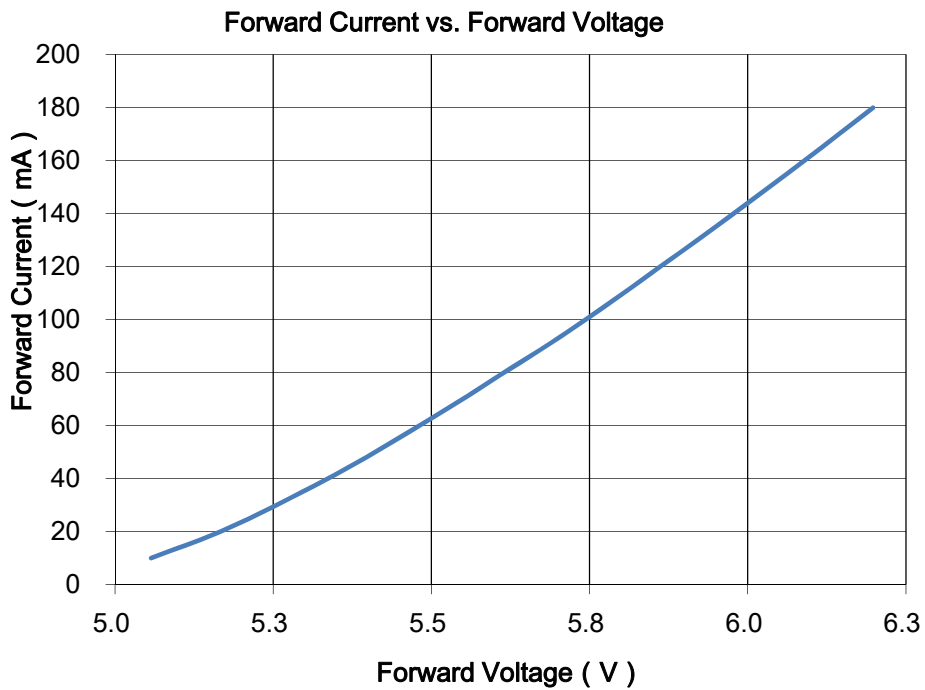

MAXIMUM CURRENT VS. AMBIENT TEMPERATURE

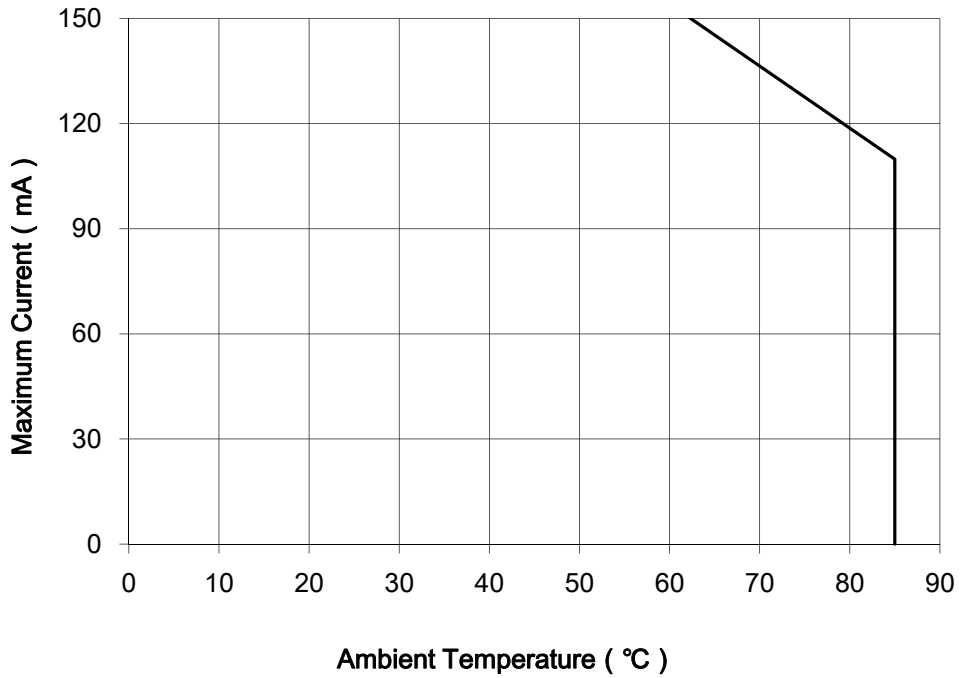

RELATIVE RADIANT FLUX VS. JUNCTION TEMPERATURE

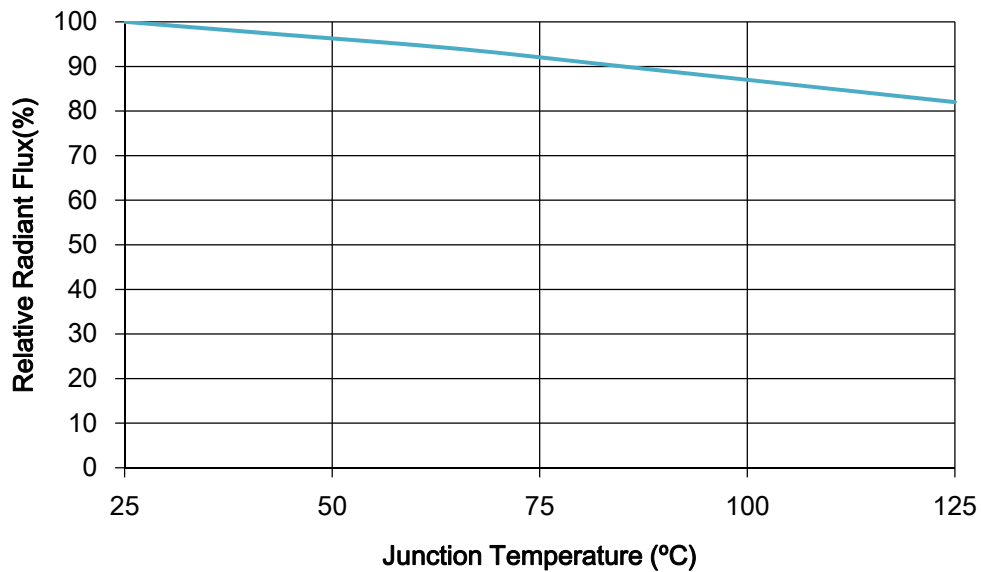

SORTING RANKS
(1) Luminous Flux (T_j=25°C)

Part Number	Condition	Rank	Unit
3030A06-27N10-2S-C6-LX	150mA	Q3	lm
		130-140	
3030A06-30N10-2S-C6-LX		Q4	
		140-150	
3030A06-40N10-2S-C6-LX		Q5	
		150-160	
3030A06-50N10-2S-C6-LX		Q5	
		150-160	
3030A06-57N10-2S-C6-LX		Q5	
		150-160	
3030A06-60N10-2S-C6-LX		Q5	
		150-160	
3030A06-65N10-2S-C6-LX	Q43		
	145-155		

(2) Forward Voltage (T_j=25°C)

Rank	Condition	Min.	Max.	Unit
C9	150mA	5.8	6.0	V
D0		6.0	6.2	
D1		6.2	6.4	
D2		6.4	6.6	

Notes:

1. 10% tolerance for luminous intensity may be caused by measurement inaccuracy.
2. Measurement Uncertainty of the Forward Voltage : ± 0.06V

(3) Chromaticity Bins

Part Number	3030A06-27N10-2S-C6-LX			CCT	2700K
Bin Code	Color Coordinates(x,y)				
A27-5	x	y	a	b	Theta°
	0.4578	0.4101	0.01290	0.00685	53.7

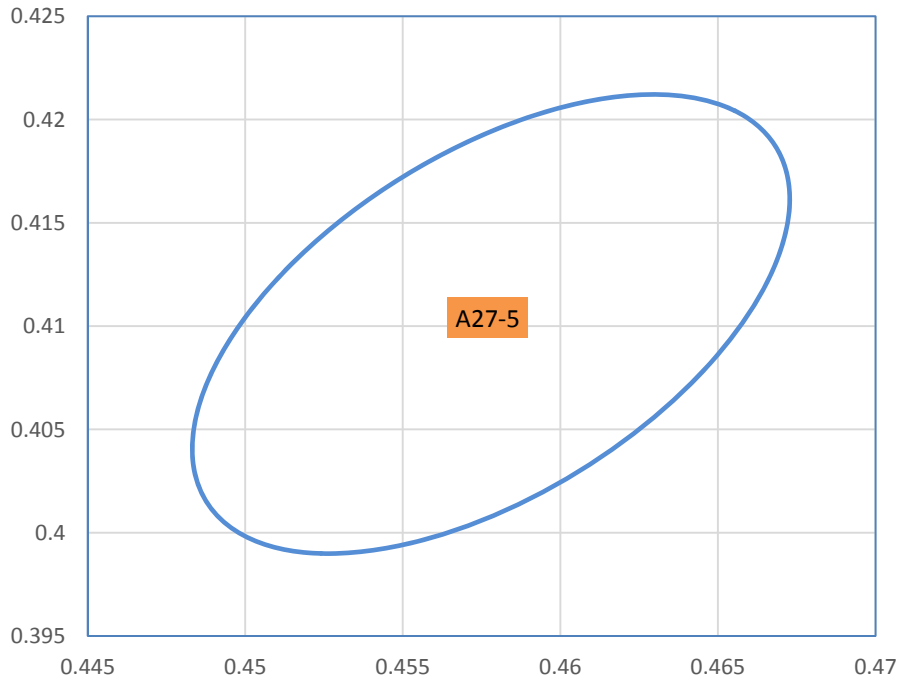

Part Number	3030A06-30N10-2S-C6-LX			CCT	3000K
Bin Code	Color Coordinates(x,y)				
A30-5	x	y	a	b	Theta°
	0.4338	0.4030	0.0139	0.0068	53.217

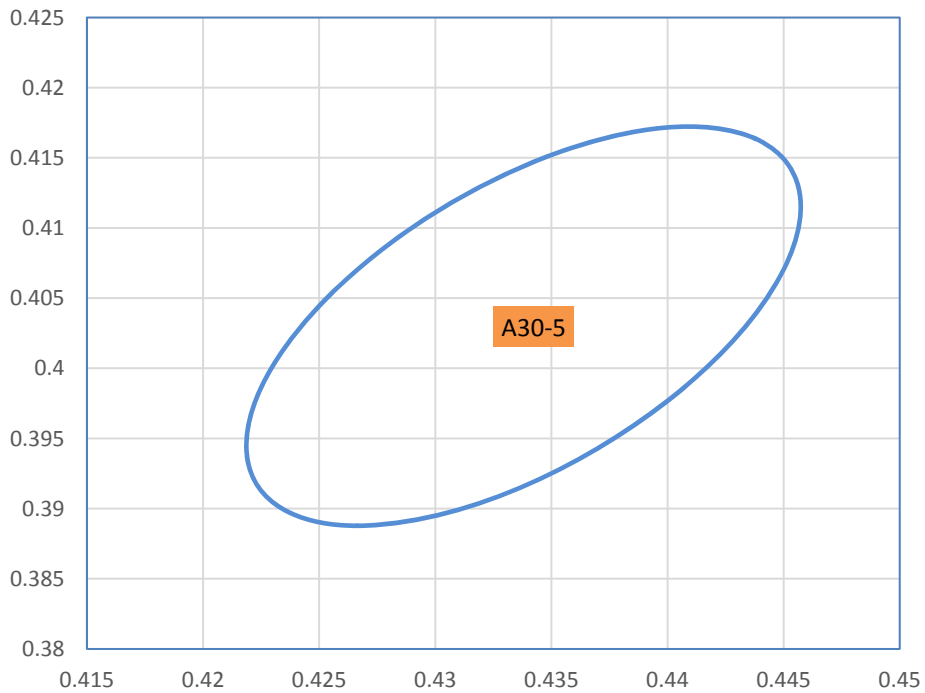

Part Number	3030A06-40N10-2S-C6-LX			CCT	4000K
Bin Code	Color Coordinates(x,y)				
A40-5	x	y	a	b	Theta°
	0.3818	0.3797	0.01565	0.0067	53.717

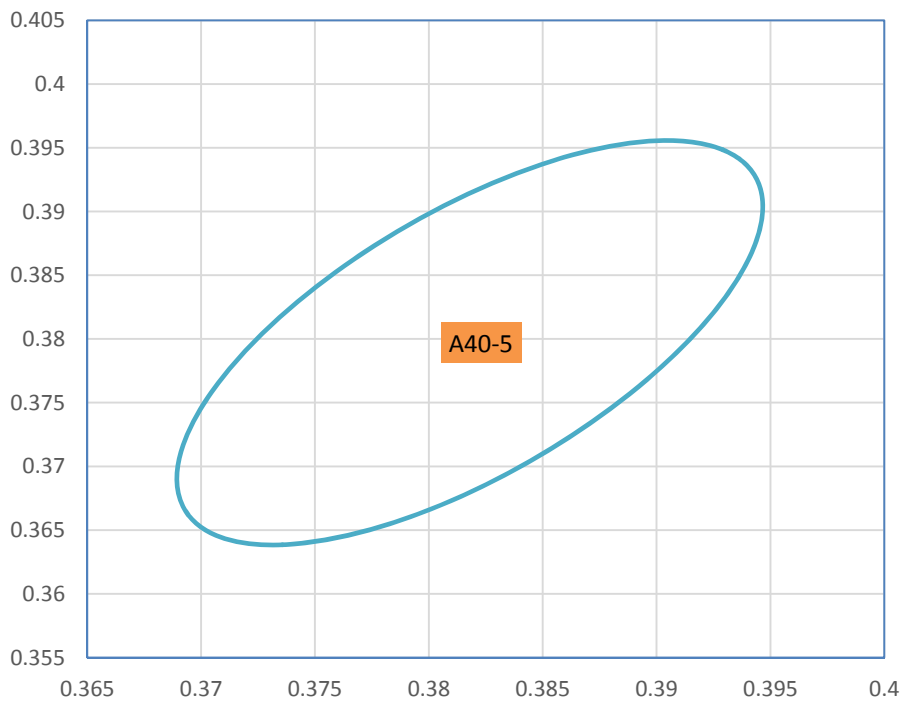

Part Number	3030A06-50N10-2S-C6-LX			CCT	5000K
Bin Code	Color Coordinates(x,y)				
A50-5	x	y	a	b	Theta°
	0.3447	0.3553	0.0137	0.0059	59.617

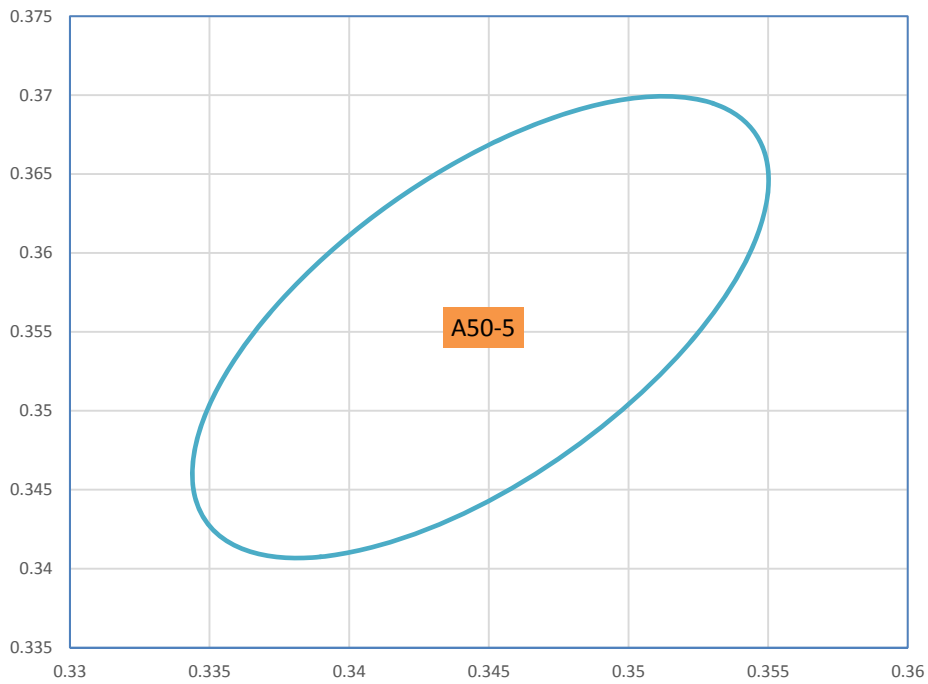

Part Number	3030A06-57N10-2S-C6-LX			CCT	5700K
Bin Code	Color Coordinates(x,y)				
A57-5	x	y	a	b	Theta°
	0.3287	0.3417	0.01243	0.00533	59.09

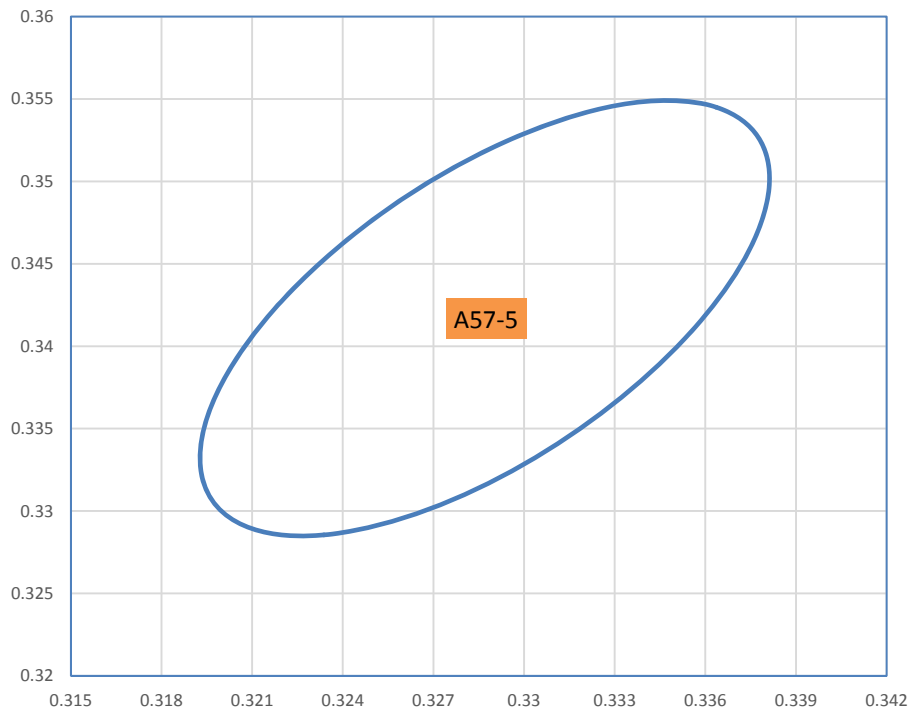

Part Number	3030A06-60N10-2S-C6-LX			CCT	6000K
Bin Code	Color Coordinates(x,y)				
A60-5	x	y	a	b	Theta°
	0.322	0.3365	0.01179	0.00504	59.21

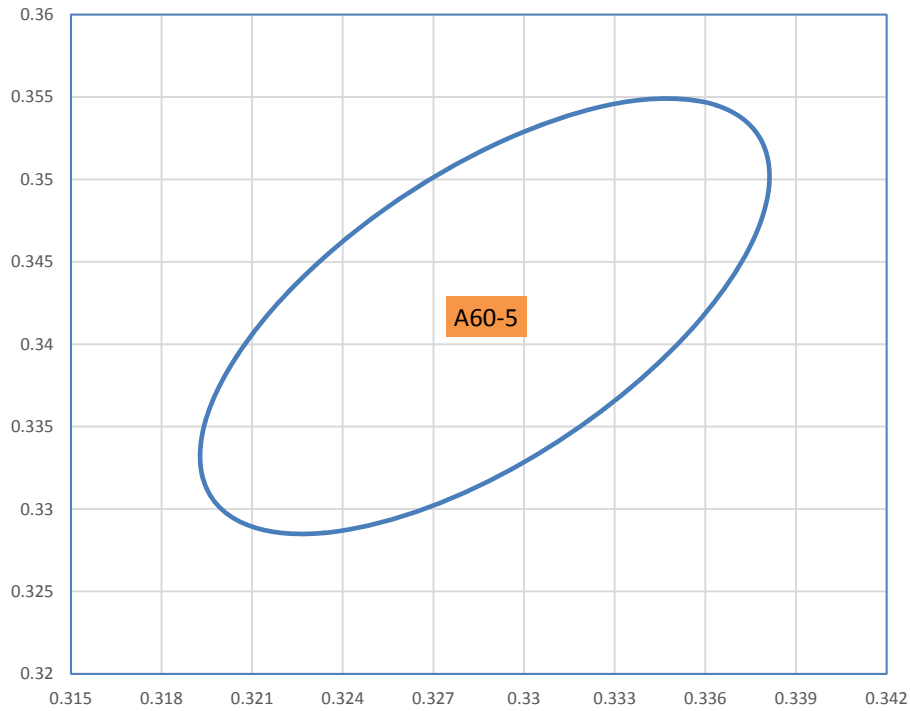

Part Number	3030A06-65N10-2S-C6-LX			CCT	6500K
Bin Code	Color Coordinates(x,y)				
A65-5	x	y	a	b	Theta°
	0.3123	0.3282	0.01115	0.00475	58.567

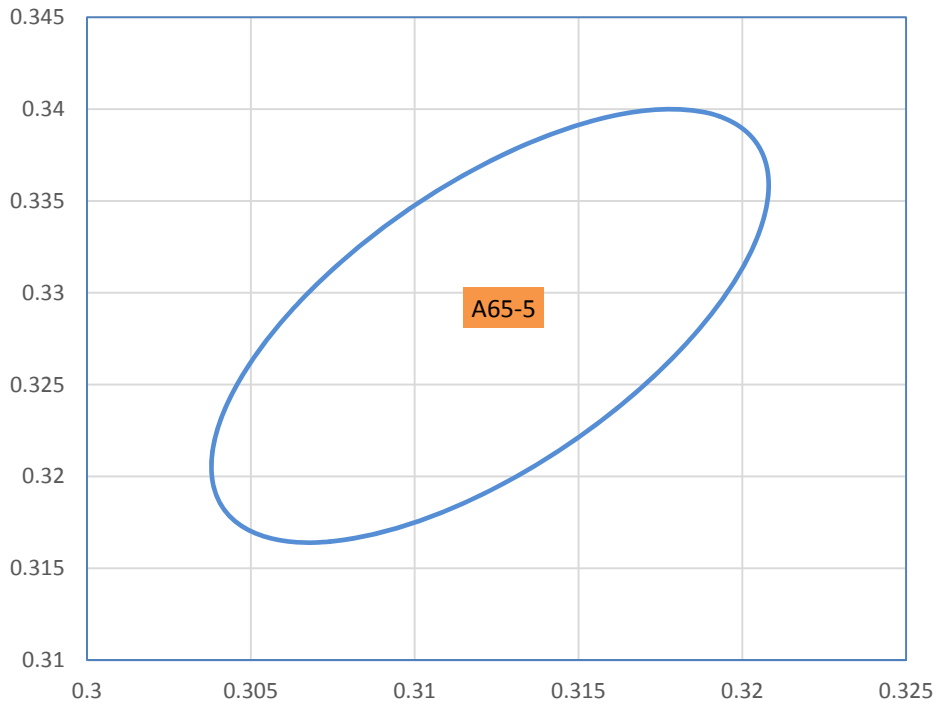

REFLOW SOLDERING CHARACTERISTICS

For Reflow Process:

Preheating : 140°C~160°C±5°C, within 2 minutes.

Operation heating : 260°C(Max.) within 10 seconds.(Max)

Gradual Cooling (Avoid quenching).

Lead solder		Lead-free solder	
Pre-heat	120-150°C	Pre-heat	150-200°C
Pre-heat time	120 sec.Max.	Pre-heat time	120 sec.Max.
Peak Temperature	240°C Max.	Peak Temperature	260°C Max.
Soldering time condition	10 sec.Max.	Soldering time condition	10 sec.Max.

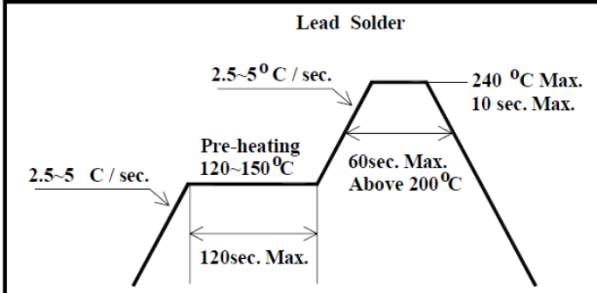
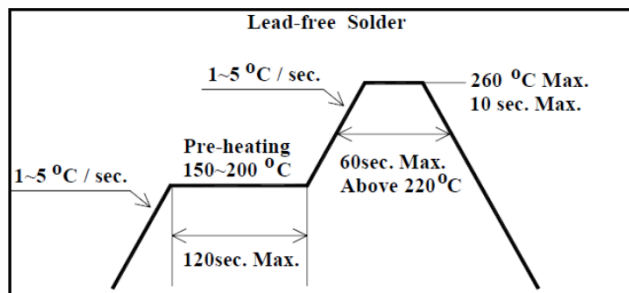
Lead Solder	Lead-free Solder
 <p>The diagram shows a reflow profile for Lead Solder. It starts with a heating ramp at 2.5-5 °C/sec. This is followed by a pre-heating plateau at 120-150°C for a maximum of 120 seconds. The temperature then rises to a peak of 240°C at a rate of 2.5-5 °C/sec. The peak is held for a maximum of 10 seconds. Finally, the temperature is cooled at 2.5-5 °C/sec. A note indicates that the time above 200°C is limited to a maximum of 60 seconds.</p>	 <p>The diagram shows a reflow profile for Lead-free Solder. It starts with a heating ramp at 1-5 °C/sec. This is followed by a pre-heating plateau at 150-200°C for a maximum of 120 seconds. The temperature then rises to a peak of 260°C at a rate of 1-5 °C/sec. The peak is held for a maximum of 10 seconds. Finally, the temperature is cooled at 1-5 °C/sec. A note indicates that the time above 220°C is limited to a maximum of 60 seconds.</p>

Notes:

The encapsulated material of the LEDs is silicone . Therefore the LEDs have a soft surface on the top of package. The pressure to the top surface will be influence to the reliability of the LEDs. Precautions should be taken to avoid the strong pressure on the encapsulated part. So when using the picking up nozzle, the pressure on the silicone resin should be proper.

TAPE AND REEL

symbol	AO	BO	KO	PO	P1	P2
Spec	3.30±0.10	3.30±0.10	1.05±0.1	4.00±0.10	4.00±0.10	2.0±0.1
symbol	W	T	E	F	DO	D1
Spec	8.0±0.2	0.20±0.05	1.75±0.10	3.5±0.05	1.50+0.1/-0	1.1±0.1

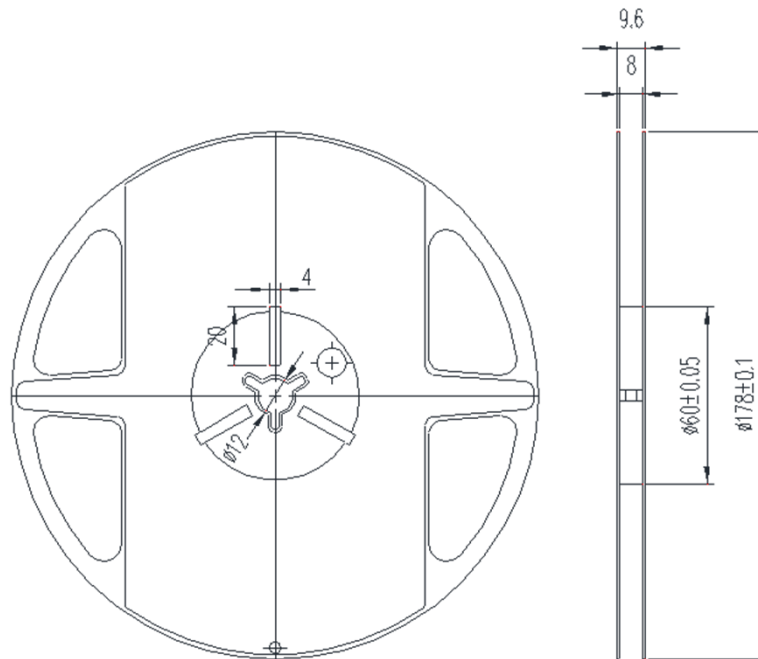
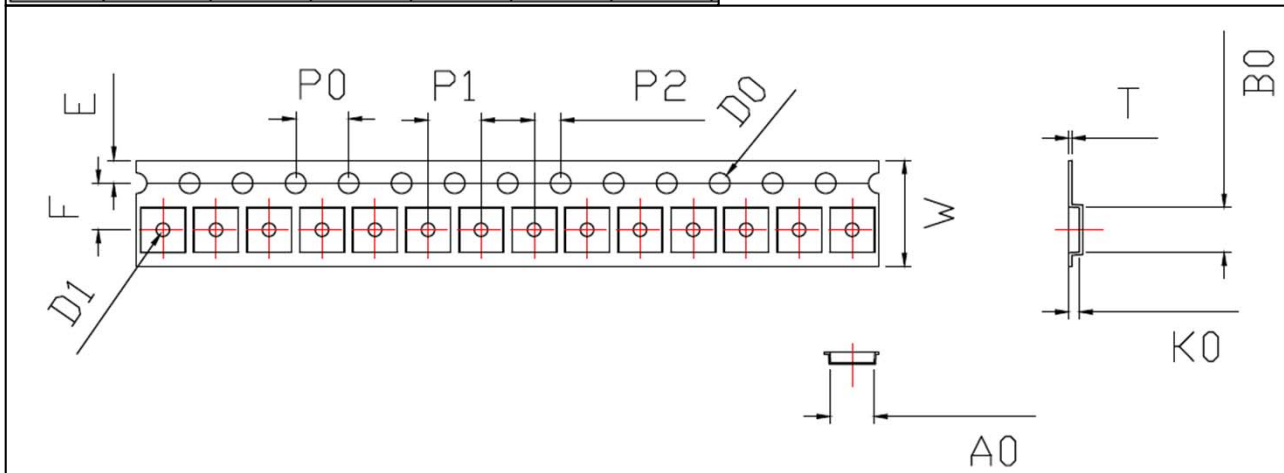

Note: The tolerances unless mentioned is $\pm 0.1\text{mm}$, Unit=mm

Notes:

- (1) Quantity : 4,000pcs/Reel
- (2) Cumulative Tolerance : Cumulative Tolerance/10 pitches to be $\pm 0.2\text{mm}$
- (3) Adhesion Strength of Cover Tape : Adhesion strength to be 0.1-0.7N when the cover tape is turned off from the carrier tape at the angle of 10° to the carrier tape
- (4) Package : P/N, Manufacturing data Code No. and quantity to be indicated on a damp proof Package.

PACKAGING

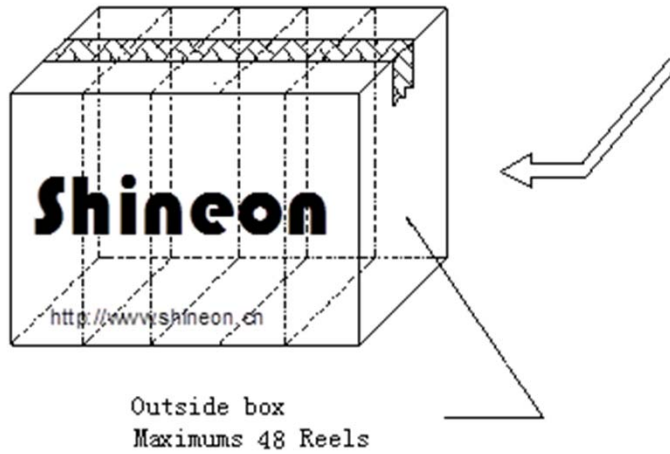
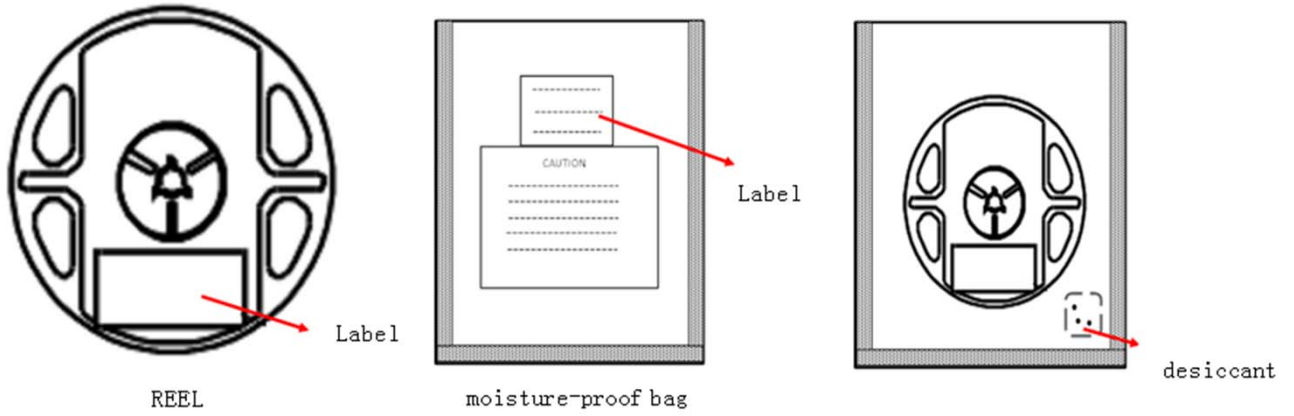

Reliability Test Items

Test Items	Test Duration	Number of Damaged
Steady State Operating Life of High Temperature (HTOL) $T_s=85^{\circ}\text{C}$, IF=Max	1000hrs	0/20
Steady State Operating Life of Low Temperature (LTOL) $T_a=-40^{\circ}\text{C}$, IF=Max	1000hrs	0/20
High Temperature Storage (HTS) 100°C	1000hrs	0/20
Low Temperature Storage (LTS) -40°C	1000hrs	0/20
Thermal Shock (TS) $-45^{\circ}\text{C}\sim 125^{\circ}\text{C}$ 15min dwell 30sec transfer	100cycles	0/20
Solder Resistance (SR) 265°C , 3X MSL	5sec	0/20
Solder Ability (SA) 245°C 5sec, 95% coverage	5sec	0/11

Item	Symbol	Test Condition	Criteria for Judgment	
			Min.	Max.
Forward	Vf	IF=Typical Current		U.S.L x1.1
Luminous Flux	Im	IF=Typical Current	L.S.L x0.7	
CCX&CCY	x,y	IF=Typical Current		Shift<0.02

PRECAUTION FOR USE

- (1) This device should not be used in any type of fluid such as water, oil, organic solvent, etc. When washing is required, IPA should be used.
- (2) When the LEDs are illuminating, operating current should be decided after considering the ambient maximum temperature.
- (3) LEDs must be stored to maintain a clean atmosphere. If the LEDs are stored for 3 months or more after being shipped from ShineOn, a sealed container with a nitrogen atmosphere should be used for storage.
- (4) The LEDs must be used within seven days after opening the moisture proof packing. Repack unused Products with anti-moisture packing, fold to close any opening and then store in a dry place.
- (5) The appearance and specifications of the product may be modified for improvement without notice.
- (6) This LED is sensitive to the static electricity and surge. It is recommended to use a wrist Band or anti-electrostatic glove when handling the LEDs.
- (7) On manual soldering, a solder tip must be needed as grounded for usage. If over voltage which exceeds the absolute maximum rating is applied to LEDs, it will cause damage LEDs and result in destruction. Damaged LEDs will show some unusual characteristics such as leak current remarkably increase ,turn-on voltage becomes lower and the LEDs get unlighted at low current.