



臻跃电子  
ZHENYUE ELECTRON



# 公司主营

The main business of the company

防水连接器  
Waterproof  
connectors

防水盒  
Waterproof  
box

接线端子  
Terminal  
blocks

公母插  
Male and  
female plugs

橡胶线  
Rubber  
wire

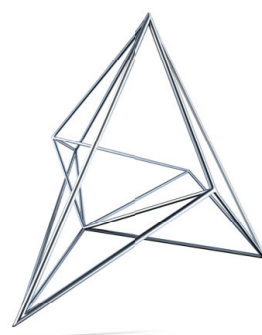

## Symmetron

МОСКВА  
Ленинградское ш., д. 69, к. 1  
Тел.: +7 495 961-20-20  
moscow@symmetron.ru

САНКТ-ПЕТЕРБУРГ  
ул. Таллинская, д. 7  
Тел.: +7 812 449-40-00  
spb@symmetron.ru

НОВОСИБИРСК  
ул. Блюхера, д. 716  
Тел.: +7 383 361-34-24  
sibir@symmetron.ru

[www.symmetron.ru](http://www.symmetron.ru)

# 企业简介

## Company Profile

广州臻跃电子科技有限公司位于广州市增城区，工厂设于东莞市桥头镇，占地面积1500平方米，是一家集研发、生产、销售于一体的现代化企业，专业制造防水连接器、防水接头、接线端子、公母对插、电缆防水接头等产品。

公司专注于IP68等级的防水连接器和接线连接器，凭借卓越的技术性能、严格的质量控制体系以及完善的销售服务，在行业中处于领先地位。产品广泛应用于户外照明、室内电源、水下设备、电缆电线、防水箱体、机电设备等多个领域。

臻跃不断推陈出新，持续开发多系列、高规格的产品，满足市场多样化需求。

Guangzhou Zhenyue Electronic Technology Co., Ltd. is located in Zengcheng District, Guangzhou, with a manufacturing facility in Qiaotou Town, Dongguan, covering an area of 1,500 square meters. We are a modern enterprise integrating R&D, production, and sales, specializing in waterproof connectors, cable glands, terminal blocks, male-female plug-in connectors, and related components.

Zhenyue focuses on IP68-rated waterproof connectors and wire connectors.

With outstanding technical performance, strict quality assurance, and attentive customer service, our products lead the industry in both standards and reliability.

Our solutions are widely used in outdoor lighting, indoor power supplies, underwater equipment, cable systems, waterproof enclosures, and electromechanical equipments.

We continuously innovate and expand our product lines to offer a diverse range of high-specification solutions tailored to various market needs.

### ■ 铜镀镍接线柱

Nickel-plated copper terminals

接线柱采用黄铜镀镍材质，有效提升导电性和抗腐蚀性能，延长使用寿命，大幅降低后期维护成本。

The terminals are made of nickel-plated brass, offering enhanced conductivity and corrosion resistance, extended service life, and significantly reduced after-sales maintenance costs.

### ■ 防水测试

Waterproof test

产品经过严格的防水测试，在4米水深条件下持续120小时测试，符合 EN60998-2-1:2004 和 EN62444:2013 防水标准。

The product has undergone rigorous waterproof testing, remaining fully sealed at a depth of 4 meters for 120 continuous hours. Test results comply with EN60998-2-1:2004 and EN62444:2013 waterproof standards.

### ■ PA66尼龙材质

PA66 nylon material

产品外壳及其他部件均采用 UL 认证的 PA66 尼龙材料。相比市面上常用的普通 PA6 材质，PA66 在抗腐蚀性、抗紫外线以及抗压强度方面表现更优，确保产品在各种环境下更耐用。

The product housing and other components are made of UL-approved PA66 nylon. Compared to the commonly used PA6, PA66 offers superior resistance to corrosion, UV exposure, and compressive stress, ensuring greater durability in demanding environments.

### ■ 证书齐全

Complete certificates

我们不断优化产品与工艺，持续提升产品品质，先后通过了 ISO9001 质量管理体系认证，以及 UL、TUV、CE、SAA、ROHS 等多项产品认证。

We continuously improve our products and manufacturing processes to enhance quality. Our company has obtained ISO9001 quality management system certification, as well as multiple product certifications including UL, TUV, CE, SAA, and RoHS.

### ■ 硅胶防水胶塞

Silicone waterproof plug

防水胶塞采用硅胶与丁腈橡胶材料，具备更强的密封性和抗拉性能，有效提升防水防尘效果。

The waterproof grommets are made of silicone and nitrile rubber (NBR), providing superior sealing and tensile strength, effectively enhancing waterproof and dustproof performance.

### ■ 款式多样

Various styles

近年来，公司不断加大在新品研发方面的投入，深入挖掘客户需求，持续推进创新设计。在保障产品质量的同时，积极实现产品多样化。

In recent years, we have increased investment in new product development, actively exploring customer needs and driving innovative design. While ensuring product quality, we continuously expand our product diversity.



# 防水连接器 Waterproof Connector

## Connector KJS-PG9-2P/3P(直通螺丝单壳款)



型号: Model:KJS-PG9-2P/3P

产品参数: Specifications

芯数: Number of Poles :2/3Pin

电压: Voltage Rating:400V

电流: Current Rating:24A

线平方数: Wire Section:0.08mm<sup>2</sup>-1.5mm<sup>2</sup>

外线直径: Min Wire Size OD:3-5mm/4-8mm

环境温度: Temperature Rating:-40'C-+105°C

防水等级: IP Code:IP68

外壳材质: Housing Materials:PA66

端子材质: Contact/Terminal Material:Nickel-Plated Brass

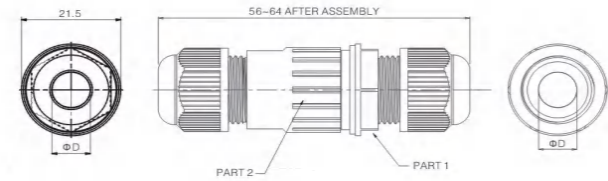

## Connector KJS-M20S-2P/3P/4P/5P(直通螺丝单壳款)



型号: Model:KJS-M20S-2P/3P/4P/5P

产品参数: Specifications

芯数: Number of Poles:2Pin/3Pin/4Pin/5pin

电压: Voltage Rating:450V

电流: Current Rating:24A

线平方数: Wire section:0.08mm<sup>2</sup>-2.5mm<sup>2</sup>

外线直径: Min Wire size OD :4-8mm,7-11mm

环境温度: Temperature Rating:-40°C-+105°C

防水等级: IP Code:IP68

外壳材质: Housing Materials :PA66

端子材质: Contact/Terminal Material:Nickel-Plated Brass

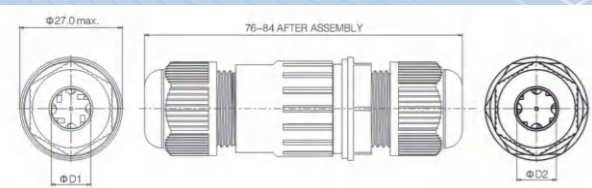

## Connector KJS-M25-2P/3P/4P/5P(直通螺丝单壳款)



型号: Model: KJS-M25-2P/3P/4P/5P

产品参数: Specifications

芯数: Number of Poles :2Pin/3Pin/4Pin/5pin

电压: Voltage Rating :450V

电流: Current Rating: 36A

线平方数: Wire Section: 0.08mm<sup>2</sup>-4.0mm<sup>2</sup>

外线直径: Min Wire Size OD : 5-8mm,8-12mm,10-14mm

环境温度: Temperature Rating: -40°C-+105°C

防水等级: IP Code : IP68

外壳材质: Housing Materials: PA66

端子材质: Contact/Terminal Material: Nickel-Plated Brass

## Connector 3Y-M20-2P/3P/4P/5P(三通Y型螺丝款)



型号: Model:3Y-M20-2P/3P/4P/5P

产品参数: Specifications

芯数: Number of Poles :2Pin/3Pin/4Pin/5pin

电压: Voltage Rating :450V

电流: Current Rating: 24A

线平方数: Wire Section:0.08mm<sup>2</sup>-2.5mm<sup>2</sup>

外线直径: Min Wire Size OD :4-8mm,7-11mm,(3-6mm) \*2

环境温度: Temperature Rating:-40°C-+105°C

防水等级: IP Code : IP68

外壳材质: Housing Materials:PA66

端子材质: Contact/Terminal Material:Nickel-Plated Brass

出线outgoing line :1TO2;1TO 3;1TO4

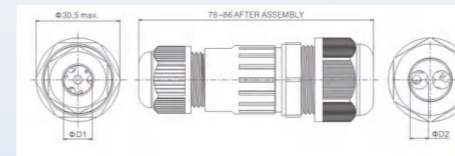

## Connector 3Y/4Y/5Y-M25-2P/3P/4P/5P(三/四/五通Y型螺丝)



型号: Model: 3Y/4Y/5Y-M25-2P/3P/4P/5P

产品参数: Specifications

芯数: Number of Poles :2Pin/3Pin/4Pin/5pin

电压: Voltage Rating :450V

电流: Current Rating: 36A

线平方数: Wire Section:0.08mm<sup>2</sup>-2.5mm<sup>2</sup>

外线直径: Min Wire Size OD :4-8mm,7-12mm,10-14mm  
(5-8.5mm)

环境温度: Temperature Rating:-40°C-+105°C

防水等级: IP Code : IP68

外壳材质: Housing Materials:PA66

端子材质: Contact/Terminal Material:Nickel-Plated Brass

出线outgoing line :1TO2;1TO 3;1TO4

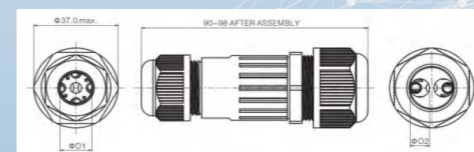

## Connector KJ-L16-2P/3P(直通螺丝单壳款)



型号: Model:KJ-L16-2P/3P

产品参数: Specifications

芯数: Number of Poles :2Pin/3Pin

电压: Voltage Rating:400V

电流: Current Rating:24A

线平方数: Wire section:0.08mm<sup>2</sup>-1.5mm<sup>2</sup>

外线直径: Min Wire Size OD:3-5mm/4-8mm

环境温度: Temperature Rating:-40°C-+105°C

防水等级: IP Code:IP68

外壳材质: Housing Materials:PA66

端子材质: Contact/Terminal Material:Nickel-Plated Brass



## 3T-M20-2P/3P/4P/5P (三通T型螺丝款)

型号: Model:3T-M20-2P/3P/4P/5P

产品参数: Specifications

芯数: Number of Poles: 2Pin/3Pin/4PIN/5PIN

电压: Voltage Rating :450V

电流: Current Rating: 24A

线平方数: Wire Section:0.08mm<sup>2</sup>-2.5mm<sup>2</sup>

外线直径: Min Wire Size OD :4-8mm,7-11mm

环境温度: Temperature Rating:-40°C-+105°C

防水等级: IP Code :Ip68

外壳材质: Housing Materials :Pa66

端子材质: Contact/Terminal Material :Nickel-Plated Brass

出线Outgoing line :1TO2

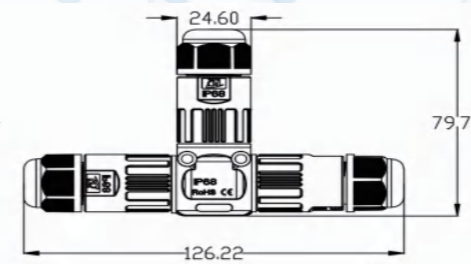

## Connector KJ-L20-2P/3P/4P/5P(直通螺丝单壳款)



型号: Model:KJ-L20-2P/3P/4P/5P

产品参数: Specifications

芯数: Number of Poles :2Pin/3Pin/4Pin/5pin

电压: Voltage Rating:450V

电流: Current Rating:24A

线平方数: Wire Section:0.08mm<sup>2</sup>-2.5mm<sup>2</sup>

外线直径: Min Wire Size OD:4-8mm,7-11mm

环境温度: Temperature Rating:-40°C-+105°C

防水等级: IP Code:IP68

外壳材质: Housing Materials :PA66

端子材质: Contact/Terminal Material:Nickel-Plated Brass



## Connector 4T-M20-2P/3P (四通螺丝款)

型号: Model:4T-M20-2P/3P

产品参数: Specifications

芯数: Number of Poles :2Pin/3Pin

电压: Voltage Rating :450V

电流: Current Rating: 24A

线平方数: Wire Section:0.08mm<sup>2</sup>-2.5mm<sup>2</sup>

外线直径: Min Wire Size OD :4-8mm,7-11mm)

环境温度: Temperature Rating:-40°C-+105°C

防水等级: IP Code :IP68

外壳材质: Housing Materials:PA66

端子材质: Contact/Terminal Material:Nickel-Plated Brass

出线outgoing line :1TO2;1TO 3;1TO 4

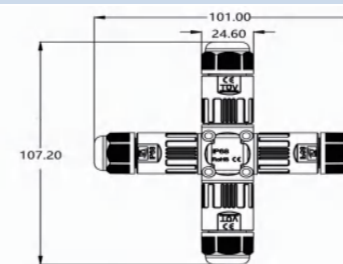

## Connector HTD-M16K-2P (直通快接款)

HOT

型号: Model:HTD-M16K-2P

产品参数: Specifications

芯数: Number of Poles: 2Pin

电压: Voltage Rating :250v

电流: Current Rating: 16A

线平方数: Wire Section:0.08mm<sup>2</sup>-1.5mm<sup>2</sup>

外线直径: Min Wire Size OD :3-5mm,4-8mm

环境温度: Temperature Rating:-40°C-+105°C

防水等级: IP Code :IP68

外壳材质: Housing Materials:PA66

端子材质: Contact/Terminal Material:Nickel-Plated Brass

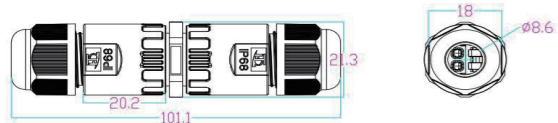

## Connector HTD-M20K-2P (直通快接款)

型号: Model:HTD-M20K-2P

产品参数: Specifications

芯数: Number of Poles: 2Pin

电压: Voltage Rating :250V

电流: Current Rating:32A

线平方数: Wire Section:0.08mm<sup>2</sup>-2.5mm<sup>2</sup>

外线直径: Min Wire Size OD :4-8mm, 7-11mm

环境温度: Temperature Rating:-40°C-+105°C

防水等级: IP Code :IP68

外壳材质: Housing Materials:PA66

端子材质: Contact/Terminal Material:Nickel-Plated Brass

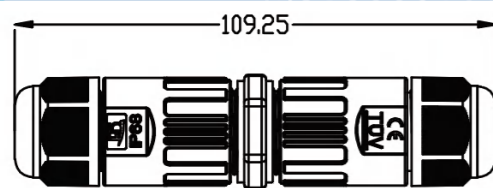

## Connector HTD-M25K-3P (直通快接款)

型号: Model:HTD-M25K-3P

产品参数: Specifications

芯数: Number of Poles :3Pin

电压: Voltage Rating :250V

电流: Current Rating:32A

线平方数: Wire Section:0.08mm<sup>2</sup>-2.5mm<sup>2</sup>

外线直径: Min Wire Size OD :4-8mm, 6-12mm

环境温度: Temperature Rating:-40°C-+105°C

防水等级: IP Code :IP68

外壳材质: Housing Materials:PA66

端子材质: Contact/Terminal Material :Nickel-Plated Brass

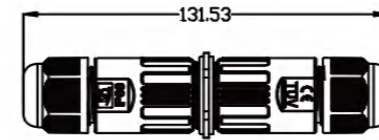

## HTD-M25-2P/3P/4P/5P (直通快接短款)

HOT

型号: Model:HTD-M25-2P/3P/4P/5P

产品参数: Specifications

芯数: Number of Poles: 2Pin/3Pin/4PIN/5PIN

电压: Voltage Rating :250V

电流: Current Rating: 32A(2P/3P)16A(4P/5P)

线平方数: Wire Section:0.08mm<sup>2</sup>-1.5mm<sup>2</sup>

外线直径: Min Wire Size OD :4-8mm, 7-12mm

环境温度: Temperature Rating:-40°C-+105°C

防水等级: IP Code :IP68

外壳材质: Housing Materials:PA66

端子材质: Contact/Terminal Material:Nickel-Plated Brass

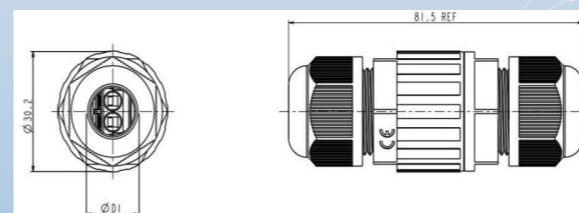

## Connector HTD-M20B-2P/3P (直通快接款)



型号: Model:HTD-M20B-2P/3P

产品参数: Specifications

芯数: Number of Poles: 2Pin/3Pin

电压: Voltage Rating :250V

电流: Current Rating: 24A

线平方数: Wire Section:0.08mm<sup>2</sup>-2.5mm<sup>2</sup>

外线直径: Min Wire Size OD :4-8mm,7-11mm

环境温度: Temperature Rating:-40°C-+105°C

防水等级: IP Code :IP68

外壳材质: Housing Materials:PA66

端子材质: Contact/Terminal Material:Nickel-Plated Brass



## Connector HTD-M25B-4P/5P (直通快接款)



型号: Model:HTD-M25B-4P/5P

产品参数: Specifications

芯数: Number of Poles: 4/5Pin

电压: Voltage Rating :250V

电流: Current Rating: 24A

线平方数: Wire Section:0.08mm<sup>2</sup>-2.5mm<sup>2</sup>

外线直径: Min Wire Size OD :4-8mm,7-11mm, 10-12mm

环境温度: Temperature Rating:-40°C-+105°C

防水等级: IP Code :IP68

外壳材质: Housing Materials:PA66

端子材质: Contact/Terminal Material:Nickel-Plated Brass



## Connector 3T-M25KJS-2P/3P/4P/5P (T型空壳款)

型号: Model:3T-M25KJS-2P/3P/4P/5P

产品参数: Specifications

芯数: Number of Poles :2Pin/3Pin/4Pin/5pin

电压: Voltage Rating :450V

电流: Current Rating: 36A

线平方数: Wire Section:0.08mm<sup>2</sup>-4.0mm<sup>2</sup>

外线直径: Min Wire Size OD :4-8mm,7-12mm,10-14mm

环境温度: Temperature Rating:-40°C-+105°C

防水等级: IP Code :IP68

外壳材质: Housing Materials:PA66

端子材质: Contact/Terminal Material:Nickel-Plated Brass

出线outgoing line :1T02;



## Connector 3Y-M25KJS-2P/3P/4P/5P (T型空壳款)

型号: Model:3Y-M25KJS-2P/3P/4P/5P

产品参数: Specifications

芯数: Number of Poles :2Pin/3Pin/4Pin/5pin

电压: Voltage Rating :450V

电流: Current Rating: 36A

线平方数: Wire Section:0.08mm<sup>2</sup>-4.0mm<sup>2</sup>

外线直径: Min Wire Size OD :4-8mm,7-12mm,10-14mm

环境温度: Temperature Rating:-40°C-+105°C

防水等级: IP Code :IP68

外壳材质: Housing Materials:PA66

端子材质: Contact/Terminal Material:Nickel-Plated Brass

出线outgoing line :1T02;



## Connector HTD-M16TK-2P (三通快接T款)



型号: Model:HTD-M16TK-2P

产品参数: Specifications

芯数: Number o Poles: 2Pin

电压: Voltage Rating :250V

电流: Current Rating:16A

线平方数: Wire Section:0.08mm<sup>2</sup>-1.5mm<sup>2</sup>

外线直径: Min Wire Size OD :3-5mm, 4-8mm

环境温度: Temperature Rating:-40°C-+105°C

防水等级: IP Code :IP68

外壳材质: Housing Materials:PA66

端子材质: Contact/Terminal Material:Nickel-Plated Brass



## Connector HTD-M20TK-2P (三通快接T款)

型号: Model:HTD-M20TK-2P

产品参数: Specifications

芯数: Number o Poles: 2Pin

电压: Voltage Rating :250V

电流: Current Rating:32A

线平方数: Wire Section:0.08mm<sup>2</sup>-2.5mm<sup>2</sup>

外线直径: Min Wire Size OD :4-8mm, 7-11mm

环境温度: Temperature Rating:-40°C-+105°C

防水等级: IP Code :IP68

外壳材质: Housing Materials:PA66

端子材质: Contact/Terminal Material:Nickel-Plated Brass

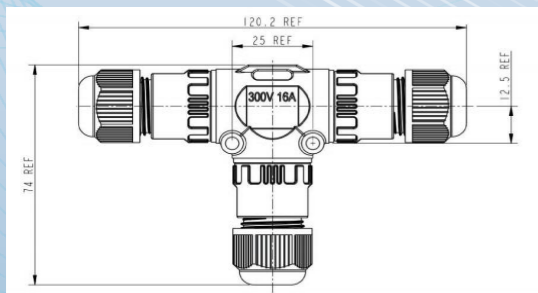

## Connector HTD-M20TB-2P/3P (三通快接T款)

型号: Model:HTD-M20TB-2P/3P

产品参数: Specifications

芯数: Number of Poles: 2Pin/3PIN

电压: Voltage Rating :250V

电流: Current Rating:24A

线平方数: Wire Section:0.08mm<sup>2</sup>-2.5mm<sup>2</sup>

外线直径: Min Wire Size OD :4-8mm, 7-11mm

环境温度: Temperature Rating:-40°C-+105°C

防水等级: IP Code :IP68

外壳材质: Housing Materials:PA66

端子材质: Contact/Terminal Material:Nickel-Plated Brass

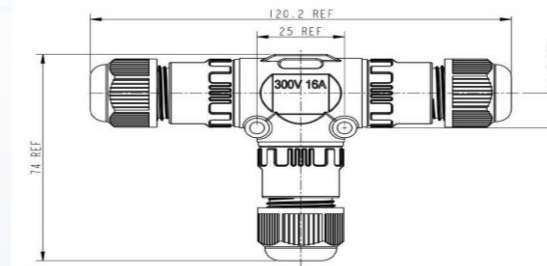

## Connector HTD-M25TK-3P (三通快接T款)

型号: Model:HTD-M25TK-3P

产品参数: Specifications

芯数: Number of Poles :3Pin

电压: Voltage Rating :250V

电流: Current Rating:32A

线平方数: Wire Section:0.08mm<sup>2</sup>-2.5mm<sup>2</sup>

外线直径: Min Wire Size OD :4-8mm, 6-12mm

环境温度: Temperature Rating:-40°C-+105°C

防水等级: IP Code :IP68

外壳材质: Housing Materials:PA66

端子材质: Contact/Terminal Material :Nickel-Plated Brass

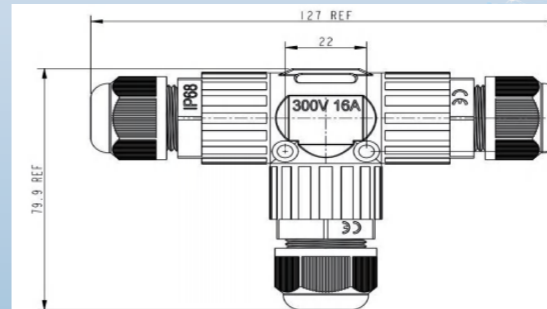

## Connector HTD-M15-2P/3P (公母螺丝款/焊接)

HOT

型号: Model:HTD-M15-2P/3P  
PScrew/welding type

产品参数: Specifications

芯数: Number of Poles: 2Pin/3Pin

电压: Voltage Rating :400V

电流: Current Rating: 24A

线平方数: Wire Section:0.08mm<sup>2</sup>-2.5mm<sup>2</sup>

外线直径: Min Wire Size OD :3-5mm, 4-8mm

环境温度: Temperature Rating:-40°C-+105°C

防水等级: IP Code :IP68

外壳材质: Housing Materials:PA66

端子材质: Contact/Terminal Material:Nickel-Plated Brass



## Connector HTD-M19-2P/3P/4P/5P (直通公母插螺丝款)

型号: Model:HTD-M19-2P/3P/4P/5P  
Screw type

产品参数: Specifications

芯数: Number of Poles: 2Pin/3Pin/4Pin/5pin

电压: Voltage Rating :450V

电流: Current Rating: 24A

线平方数: Wire Section:0.08mm<sup>2</sup>-2.5mm<sup>2</sup>

外线直径: Min Wire Size OD :4-8mm,7-11mm

环境温度: Temperature Rating:-40°C-+105°C

防水等级: IP Code :IP68

外壳材质: Housing Materials:PA66

端子材质: Contact/Terminal Material:Nickel-Plated Brass

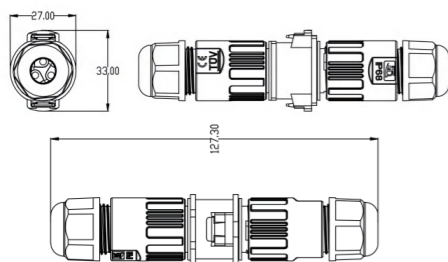

## Connector HTD-M19B-2P/3P (直通公母插快接款)

NEW

型号: Model:HTD-M19B-2P/3P  
Screw-free quick-connect

产品参数: Specifications

芯数: Number of Poles: 2Pin/3Pin

电压: Voltage Rating :250V

电流: Current Rating: 24A

线平方数: Wire Section:0.08mm<sup>2</sup>-2.5mm<sup>2</sup>

外线直径: Min Wire Size OD :4-8mm,7-11mm

环境温度: Temperature Rating:-40°C-+105°C

防水等级: IP Code :IP68

外壳材质: Housing Materials:PA66

端子材质: Contact/Terminal Material:Nickel-Plated Brass



## Connector HTD-M25 (直通网线款)

NEW

型号: Model:HTD-M25 Network connector

产品参数: Specifications

芯数: Number of Poles :5/6类

电压: Voltage Rating :0V

电流: Current Rating:0A

环境温度: Temperature Rating:-40°C-+105°C

防水等级: IP Code :IP68

外壳材质: Housing Materials:PA66

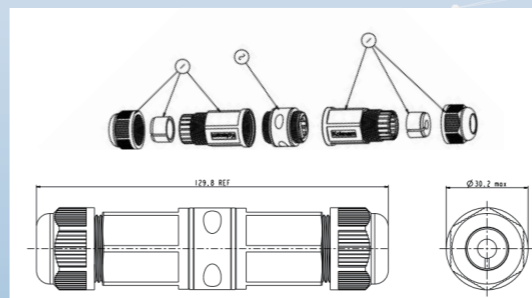

## 接线端子系列 Wiring Connector Series

### 21系列常规款-尼龙材质 21 Series/regular type Nylon material

接线范围

Wire Range

硬线/solid wire : 0.08-4mm<sup>2</sup> 电压/Voltage: 250V

软线/Strand wire: 0.08-2.5mm<sup>2</sup> 电流/Current: 32A



PCT-212

尺寸

12.5x21x14.4mm



PCT-213

尺寸

17.1x21x14.4mm



PCT-214

尺寸

21.7x21x14.4mm



PCT-215

尺寸

26.3x21x14.4mm



PCT-218

尺寸

40.4x21x14.4mm

HOT

### 橙色手柄 Orange handle

接线范围

Wire Range

硬线/solid wire : 0.08-4mm<sup>2</sup> 电压/Voltage: 250V

软线/Strand wire: 0.08-2.5mm<sup>2</sup> 电流/Current: 32A



PCT-2-1

尺寸

13.6x40.3x14.5mm



PCT-2-2

尺寸

13.6x40.3x14.5mm



PCT-2-3

尺寸

18.6x40.3x14.5mm



PCT-2-4

尺寸

23.6x40.3x14.5mm



PCT-2-5

尺寸

28.6x40.3x14.5mm

HOT

### 彩色手柄 Colorful handles

接线范围

Wire Range

硬线/solid wire : 0.08-4mm<sup>2</sup> 电压/Voltage: 250V

软线/Strand wire: 0.08-2.5mm<sup>2</sup> 电流/Current: 32A

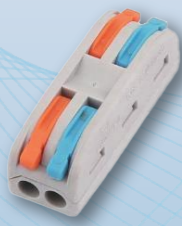

PCT-2-2



PCT-2-3



PCT-2-4



PCT-2-5

### 4mm<sup>2</sup>分线器-尼龙材质:4mm<sup>2</sup> 4mm<sup>2</sup> Deconcentrator-Nylon material

接线范围

Wire Range

硬线/solid wire : 0.08-4mm<sup>2</sup> 电压/Voltage: 250V

软线/Strand wire: 0.08-2.5mm<sup>2</sup> 电流/Current: 32A



PCT-422

尺寸

24.55x31.5x13.5mm



PCT-622

尺寸

33x31.5x13.5mm

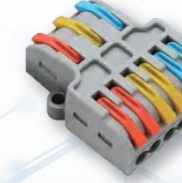

PCT-623

尺寸

33x31.5x13.5mm



PCT-923

尺寸

48x31.5x13.5mm

### 41系列 41 Series

接线范围

Wire Range

硬线/solid wire : 0.2-4mm<sup>2</sup> 电压/Voltage: 450V

软线/Strand wire: 0.2-4mm<sup>2</sup> 电流/Current: 32A



PCT-412

尺寸

13x19.4x9.6mm



PCT-413

尺寸

13x19.4x9.6mm



PCT-414

尺寸

13x19.4x9.6mm



PCT-415

尺寸

13x19.4x9.6mm

HOT

### 迷你常规款-尼龙材质 Mini regular type -Nylon materia

接线范围

Wire Range

硬线/solid wire : 0.08-1.5mm<sup>2</sup> 电压/Voltage: 250V

软线/Strand wire: 0.08-1.5mm<sup>2</sup> 电流/Current: 16A



PCT-2-2M

尺寸

26.1x11.14x8.45mm



PCT-2-3M

尺寸

26.1x11.14x11.92mm



PCT-2-4M

尺寸

26.1x11.14x15.43mm



PCT-2-5M

尺寸

26.1x11.14x19mm

NEW

## 923 端子台 923 terminal block

### 常规款(不带按钮, 底部带钩)Regular model (without button,with hook at the bottom)

#### 接线范围

Wire Range

软线需加锡

电压/Voltage: 450V

软线/Strand wire: 0.5-2.5mm<sup>2</sup> 电流/Current: 16A



923-2

尺寸

19.7x25.4x21.65mm带钩



923-3

尺寸

29.7x25.4x21.65mm带钩



923-4

尺寸

39.7x25.4x21.65mm带钩



923-5

尺寸

49.7x25.4x21.65mm带钩

### 按钮款(带按钮, 底部带钩)Button type (with button and hook at the bottom)

#### 接线范围

Wire Range

软线需加锡

电压/Voltage: 450V

软线/Strand wire: 0.5-2.5mm<sup>2</sup> 电流/Current: 16A

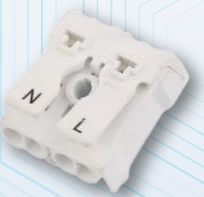

923-2B

尺寸

19.7x25.4x23.12mm带钩



923-3B

尺寸

29.7x25.4x23.12mm带钩



923-4B

尺寸

39.7x25.4x23.12mm带钩



923-5B

尺寸

49.7x25.4x23.12mm带钩

### 新款快速接头 Splicing type multifunction wire connector

#### 接线范围

Wire Range

硬线/solid wire : 0.2~ 4mm<sup>2</sup> 软线/Strand wire: 0.14 ~4mm<sup>2</sup>

电压/Voltage: 250V 电流/Current: 16A

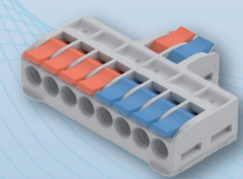

2222-62P

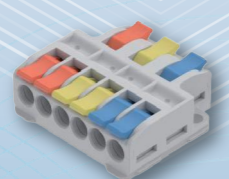

2222-63P

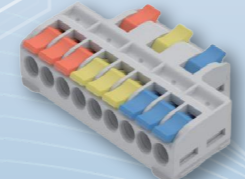

2222-93P



2222-84P

### 免破线快速接头Break free quick connector

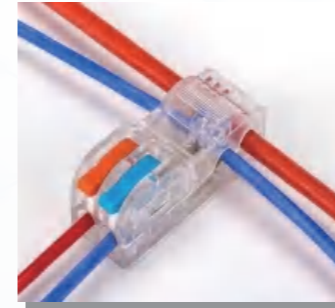

T22

尺寸

13x431x13.4mm

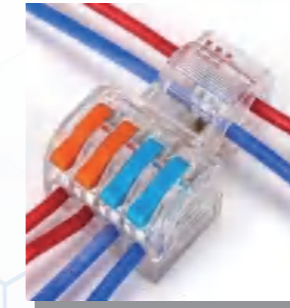

T24

尺寸

13x431x13.4mm

#### 接线范围

Wire Range

T端

A:0.5-1.5mm<sup>2</sup>

B:1.5-2.5mm<sup>2</sup>

C:2.5-6.0mm<sup>2</sup>

分线/Branch:

硬线/Solid wire: 0.08-4mm<sup>2</sup>

软线/Strand wire: 0.08-2.5mm<sup>2</sup>

电压/Voltage: 250V

电流/Current: 32A

只需一个端子零火线同时免破线, 实现二进二出或者四进四出。  
分线快速接线端子设计, 只需开合手柄快速括拔电线。

### 可拼接式多功能快速接头Splicing type multifunction wire connecto

#### 接线范围

Wire Range

硬线/solid wire : 0.2-4mm<sup>2</sup> 电压/Voltage: 450V

软线/Strand wire: 1.4-4mm<sup>2</sup> 电流/Current: 32A



2604D-2P



2604D-3P



2604D-3P



2604D-5P

### 新款快速接头 Splicing type multifunction wire connector

#### 接线范围

Wire Range

硬线/solid wire : 0.2-4mm<sup>2</sup> 电压/Voltage: 250V

软线/Strand wire: 0.14-4mm<sup>2</sup> 电流/Current: 16A

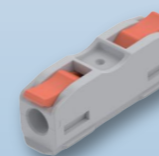

2222-2P

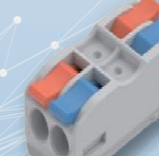

2222-2P



2222-3P

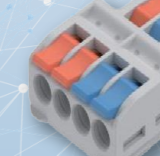

2222-42P



2222-62P

# 6平方大功率系列

NEW

## 常规款 6 square meters high power

接线范围  
Wire Range

电压/Voltage: 450V 0.5-6mm<sup>2</sup>  
电流/Current: 40A

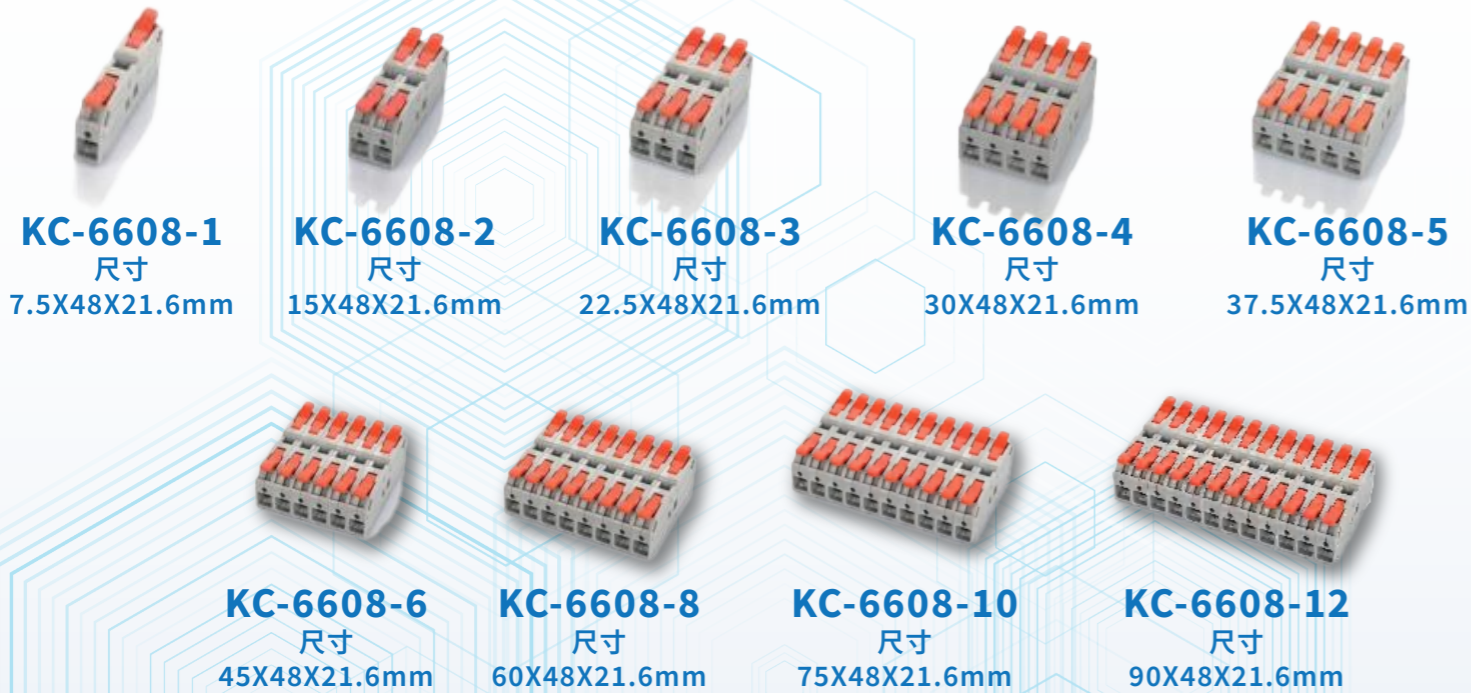

### KC-6608B款固定款 KC-6608B series:fixed type

接线范围  
Wire Range

电压/Voltage: 450V 0.5-6mm<sup>2</sup>  
电流/Current: 40A



# 轨道6平方大功率系列

NEW

## 轨道款Track 6 square high power

接线范围  
Wire Range

电压/Voltage: 450V 0.5-6mm<sup>2</sup>  
电流/Current: 40A



# KC-6601系列分线器

## KC-6601 Series splitter terminal



在左右两侧可按需增加孔位,比如KC-6601-1-3在右侧加三片孔位,可以变成KC-6601-1-6  
It can add poles at left or right side,like KC-6601-1-3,we can add 3 poles at right side,which turn to kc-6601-1-6.



分线器自定义组合设计:KC-6608和KC-6601系列可以自由按需组合一起。  
 Custom combination design of splitters:KC-6608& KC-6601 series can combine.  
 比如可以把多个KC-6601系列组合。它可以在左右两侧按需增加孔位。  
 For example:we can combine several KC-6601 series .As photo 2 pcs KC-6601-1-2 combined into KC-6601-2-4.

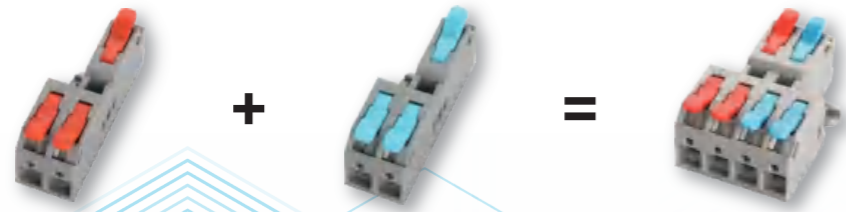

### 带耳固定款分线器 With fixed ears splitter terminal

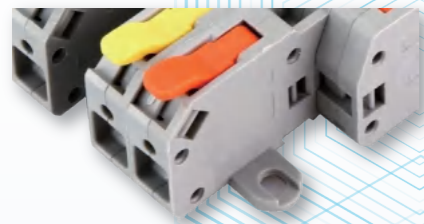

左右两边有固定孔位,可以定制无耳或者单耳。  
 There are fixed holes on the left and right sides, which can be customized without ears or single ears

接线范围  
 Wire Range

电压/Voltage: 450V  
 0.5-6mm<sup>2</sup>  
 电流/Current: 40A

- |                                          |                                            |                                           |                                              |
|------------------------------------------|--------------------------------------------|-------------------------------------------|----------------------------------------------|
| <b>KC-6601-2-4</b><br>尺寸<br>30X48X21.6mm | <b>KC-6601-2-6</b><br>尺寸<br>45X48X21.6mm   | <b>KC-6601-2-8</b><br>尺寸<br>60X48X21.6mm  | <b>KC-6601-2-10</b><br>尺寸<br>75X48X21.6mm    |
| <b>KC-6601-3-6</b><br>尺寸<br>45X48X21.6mm | <b>KC-6601-3-9</b><br>尺寸<br>67.5X48X21.6mm | <b>KC-6601-3-12</b><br>尺寸<br>90X48X21.6mm | <b>KC-6601-3-15</b><br>尺寸<br>112.5X48X21.6mm |
| <b>KC-6601-4-8</b><br>尺寸<br>60X48X21.6mm | <b>KC-6601-4-12</b><br>尺寸<br>90X48X21.6mm  | <b>KC-6601-5-10</b><br>尺寸<br>75X48X21.6mm | <b>KC-6601-5-15</b><br>尺寸<br>112.5X48X21.6mm |

也可以KC-6601系列和KC-6608系列组合  
 we also can combine KC-6601& KC-6608 series.As photo,KC-6601-1-2 + KC-6608-1 + KC-6601-1-3 =KC-6601-3-6.

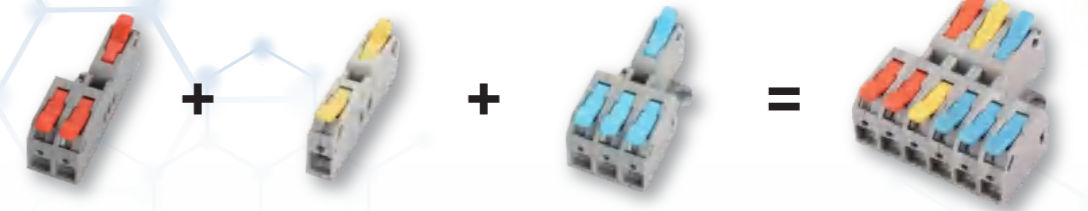

### 轨道款分线器 Din-railtype splitter terminal

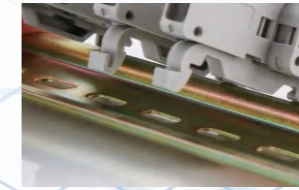

底部带轨道脚,可按需安装1到多个轨道脚。  
 There are din-rail feet on bottom,which can be installed 1 to more feet on demand

接线范围  
 Wire Range

电压/Voltage: 450V  
 0.5-6mm<sup>2</sup>  
 电流/Current: 40A

- |                                           |                                             |                                            |                                               |
|-------------------------------------------|---------------------------------------------|--------------------------------------------|-----------------------------------------------|
| <b>KC-6601-2-4D</b><br>尺寸<br>30X48X32.6mm | <b>KC-6601-2-6D</b><br>尺寸<br>45X48X32.6mm   | <b>KC-6601-2-8D</b><br>尺寸<br>60X48X32.6mm  | <b>KC-6601-2-10D</b><br>尺寸<br>75X48X32.6mm    |
| <b>KC-6601-3-6D</b><br>尺寸<br>45X48X32.6mm | <b>KC-6601-3-9D</b><br>尺寸<br>67.5X48X32.6mm | <b>KC-6601-3-12D</b><br>尺寸<br>90X48X32.6mm | <b>KC-6601-3-15D</b><br>尺寸<br>112.5X48X32.6mm |
| <b>KC-6601-4-8D</b><br>尺寸<br>60X48X32.6mm | <b>KC-6601-4-12D</b><br>尺寸<br>90X48X32.6mm  | <b>KC-6601-5-10D</b><br>尺寸<br>75X48X32.6mm | <b>KC-6601-5-15D</b><br>尺寸<br>112.5X48X32.6mm |

## Connector PI-ML16-2P 板端快接款



产品参数: Specifications

芯数: Number of Poles: 2Pin

电压: Voltage Rating :250V

电流: Current Rating: 16A

线平方数: Wire Section:0.08mm<sup>2</sup>-1.5mm<sup>2</sup>

外线直径: Min Wire Size OD :3-5mm, 4-8mm

环境温度: Temperature Rating:-40°C-+105°C

防水等级: IP Code :IP68

外壳材质: Housing Materials:PA66

端子材质: Contact/Terminal Material:Nickel-Plated Brass

## Connector PI-ML20-2P 板端快接款

型号: Model:PI-ML20-2P

产品参数: Specifications

芯数: Number of Poles: 2Pin

电压: Voltage Rating :250V

电流: Current Rating: 32A

线平方数: Wire Section:0.08mm<sup>2</sup>-2.5mm<sup>2</sup>

外线直径: Min Wire Size OD :4-8mm,7-10.5mm

环境温度: Temperature Rating:-40°C-+105°C

防水等级: IP Code :IP68

外壳材质: Housing Materials:PA66

端子材质: Contact/Terminal Material:Nickel-Plated Brass



## Connector PI-ML19-2P/3P

型号: Model:PI-ML19-2P/3P

产品参数: Specifications

螺纹外径: M20

芯数: Number of Poles: 2Pin/3Pin

电压: Voltage Rating :450V

电流: Current Rating: 24A

线平方数: Wire Section:0.08mm<sup>2</sup>-2.5mm<sup>2</sup>

外线直径: Min Wire Size OD :4-8mm,7-10.5mm

环境温度: Temperature Rating:-40°C-+105°C

防水等级: IP Code :IP68

外壳材质: Housing Materials:PA66

端子材质: Contact/Terminal Material:Nickel-Plated Brass



## Connector HTD-Y13K-2P 快速安装免螺丝

型号: Model:HTD-Y13K-2P

产品参数: Specifications

线材范围: Wire range:2\*0.75/1.0/1.5/2.5mm<sup>2</sup>

一进多出: One in, many out:1-2to/3to/4to/5to/6to

芯数: Number of Poles: 2Pin

电压: Voltage Rating :250V

电流: Current Rating: 32A

线平方数: Wire Section:0.08mm<sup>2</sup>-2.5mm<sup>2</sup>

外线直径: Min Wire Size OD :4-8mm,7-10.5mm

环境温度: Temperature Rating:-40°C-+105°C

防水等级: IP Code :IP68

外壳材质: Housing Materials:PA66

端子材质: Contact/Terminal Material:Nickel-Plated Brass



## M8/M10/M12防水公母插连接线 M8/M10/M12 male and female connector

型号: Model:HTD-M8/M10/M12-2P/3P/4P/5P

产品参数: Specifications

芯数: Number of Poles 2Pin/3Pin/4Pin/5Pin

电压: Voltage Rating :400V

电流: Current Rating: 24A

线平方数: Wire Section:0.08mm<sup>2</sup>-1.5mm<sup>2</sup>

环境温度: Temperature Rating:-40°C-+105°C

防水等级: IP Code:IP68

外壳材质: Housing Materials:PA66



## M12隔水器 M12 water separator

型号: Model:HTD-M12-2P/3P

产品参数: Specifications

芯数: Number of Poles 2Pin/3Pin

电压: Voltage Rating: 400V

电流: Current Rating: 24A

线平方数: Wire Section:0.08mm<sup>2</sup>-1.5mm<sup>2</sup>

环境温度: Temperature Rating:-40°C-+105°C

防水等级: IP Code:IP68

外壳材质: Housing Materials:PA66

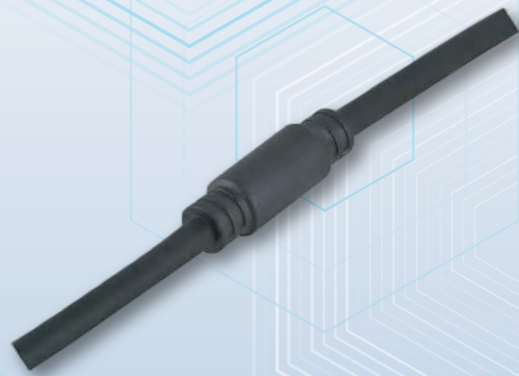

## M15防水公母插连接器M15 waterproof male and female connector

型号: Model:HTD-M15-2P/3P

产品参数: Specifications

芯数: Number of Poles 2Pin/3Pin

电压: Voltage: Rating: 400V

电流: Current Rating: 24A

线平方数: Wire Section:0.08mm<sup>2</sup>-1.5mm<sup>2</sup>

环境温度: Temperature Rating:-40°C-+105°C

防水等级: IP Code:IP68

外壳材质: Housing Materials:PA66



## M15-F型防水公母插连接器M15-f waterproof male and female connector

型号: Model:HTD-M15-F2/F3/F4/F5/F6

产品参数: Specifications

芯数: Number of Poles 2Pin/3Pin

电压: Voltage Rating: 400V

电流: Current Rating: 24A

线平方数: Wire Section:0.08mm<sup>2</sup>-1.5mm<sup>2</sup>

环境温度: Temperature Rating:-40°C-+105°C

防水等级: IP Code:IP68

外壳材质: Housing Materials:PA66



## Connector XY-M20T型公母型

NEW

型号: Model: XY-M20T-T-type male and female

产品参数: Specifications

芯数: Number of Poles: 2Pin/3PIN

电压: Voltage Rating :250V

电流: Current Rating: 32A

线平方数: Wire Section: 0.08mm<sup>2</sup>-2.5mm<sup>2</sup>

环境温度: Temperature Rating: -40°C-+105°C

防水等级: IP Code :IP67

外壳材质: Housing Materials: PA66

端子材质: Contact/Terminal Material: Nickel-Plated Brass



## Connector HTD-Y11/Y13/Y15-2P

型号: Model: HTD-Y11/Y13/Y15-2P

产品参数: Specifications

线材范围: Wire range: 2\*0.75/1.0/1.5/2.5mm<sup>2</sup>

一进多出: One in, many out: 1-2to/3to/4to/5to/6to

芯数: Number of Poles: 2Pin

电压: Voltage Rating :450V

电流: Current Rating: 24A

线平方数: Wire Section: 0.08mm<sup>2</sup>-2.5mm<sup>2</sup>

外线直径: Min Wire Size OD : 4-8mm, 7-10.5mm

环境温度: Temperature Rating: -40°C-+105°C

防水等级: IP Code :IP68

外壳材质: Housing Materials: PA66

端子材质: Contact/Terminal Material: Nickel-Plated Brass



## 圆形防水盒-H2/H3/H4

型号: Model: H2/H3/H4  
Round waterproof box

Model

防水等级: IP68  
Waterproof grade:

外壳材质: 尼龙PA66  
Enclosure material:

穿线孔径: 4-8mm/8-10.5mm  
Threading hole diameter:

适配电缆: 2x0.75<sup>2</sup>~3x2.5<sup>2</sup>  
Adapter cable:

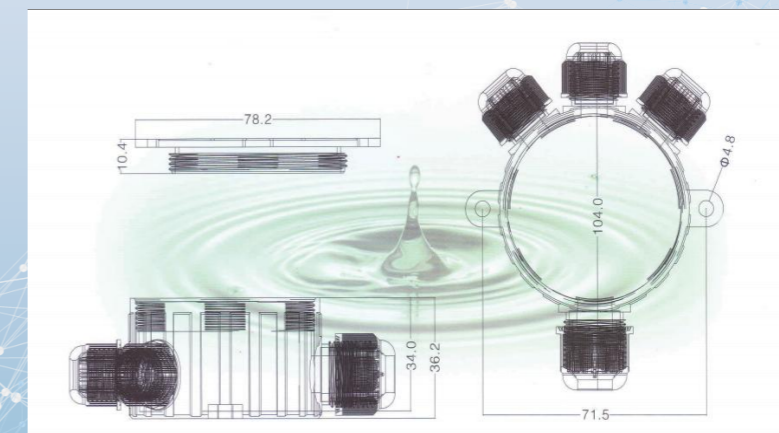
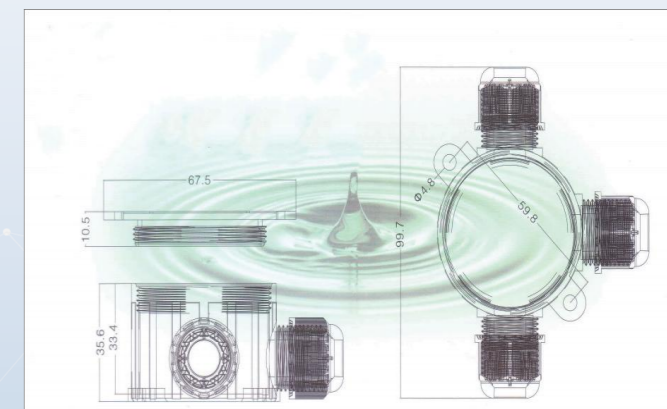
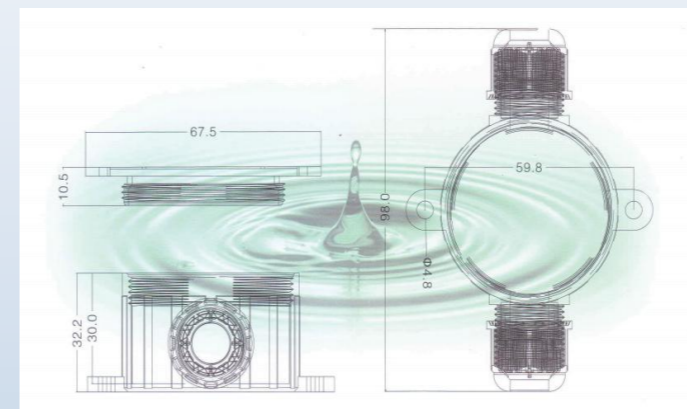

## IP68(中号)防水接线盒 IP68 waterproof junction box

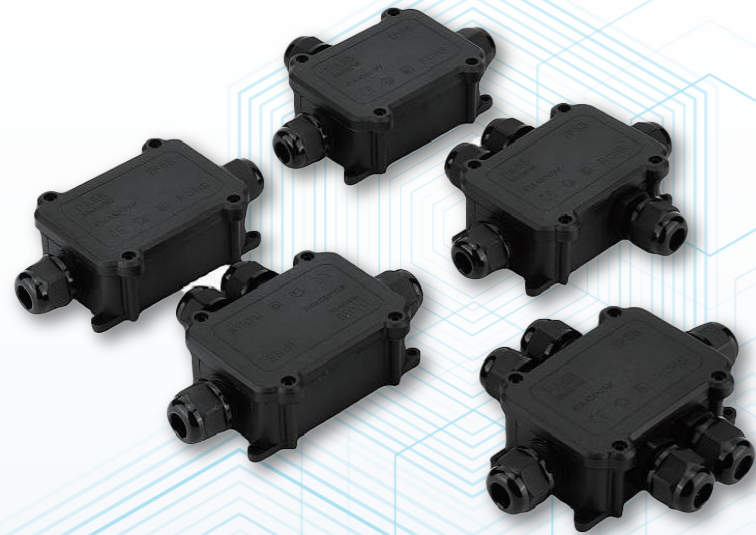

### 型号: CDE101-2T/3T/4T/5T/6T

Model

防水等级: IP68  
Waterproof grade:

外壳材质: 尼龙PA66  
Enclosure material:

外尺寸: 131.2\*68.8\*36.9mm  
External dimension:

内尺寸: 75.5\*45.5\*35mm  
Internal dimensions:

穿线孔径: 5-8mm/8-12mm  
Threading hole diameter:

适配电缆: 2x0.75<sup>2</sup>~3x2.5<sup>2</sup>  
Adapter cable:

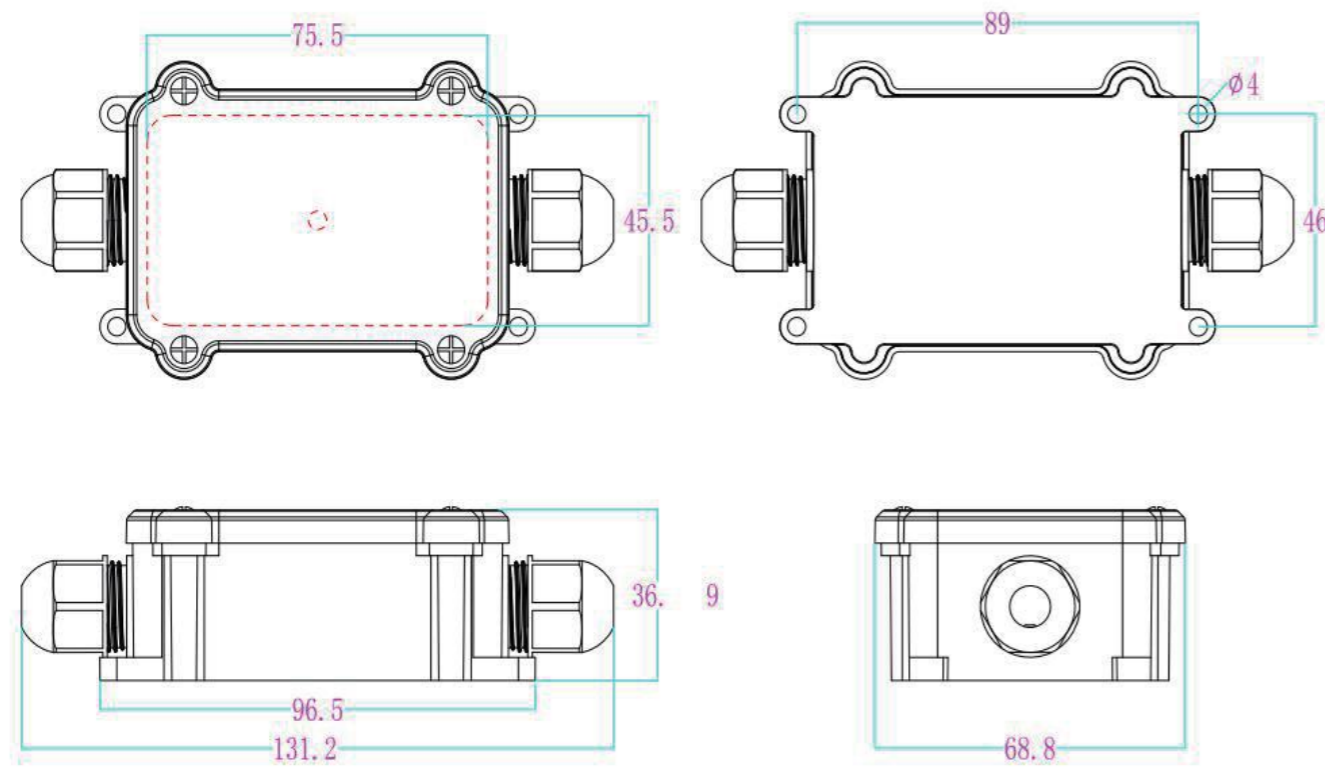

## IP68(大号)防水接线盒 IP68 waterproof junction box



### 型号: CDE102-2T/3T/4T/5T/6T

Model

防水等级: IP68  
Waterproof grade:

外壳材质: 尼龙PA66  
Enclosure material:

外尺寸: 160\*118\*47.9mm  
External dimension:

内尺寸: 100.3\*60.3\*47mm  
Internal dimensions:

穿线孔径: 5-8mm/8-12mm/10-14mm  
Threading hole diameter:

适配电缆: 2x0.75<sup>2</sup>~3x2.5<sup>2</sup>~3\*4<sup>2</sup>  
Adapter cable:

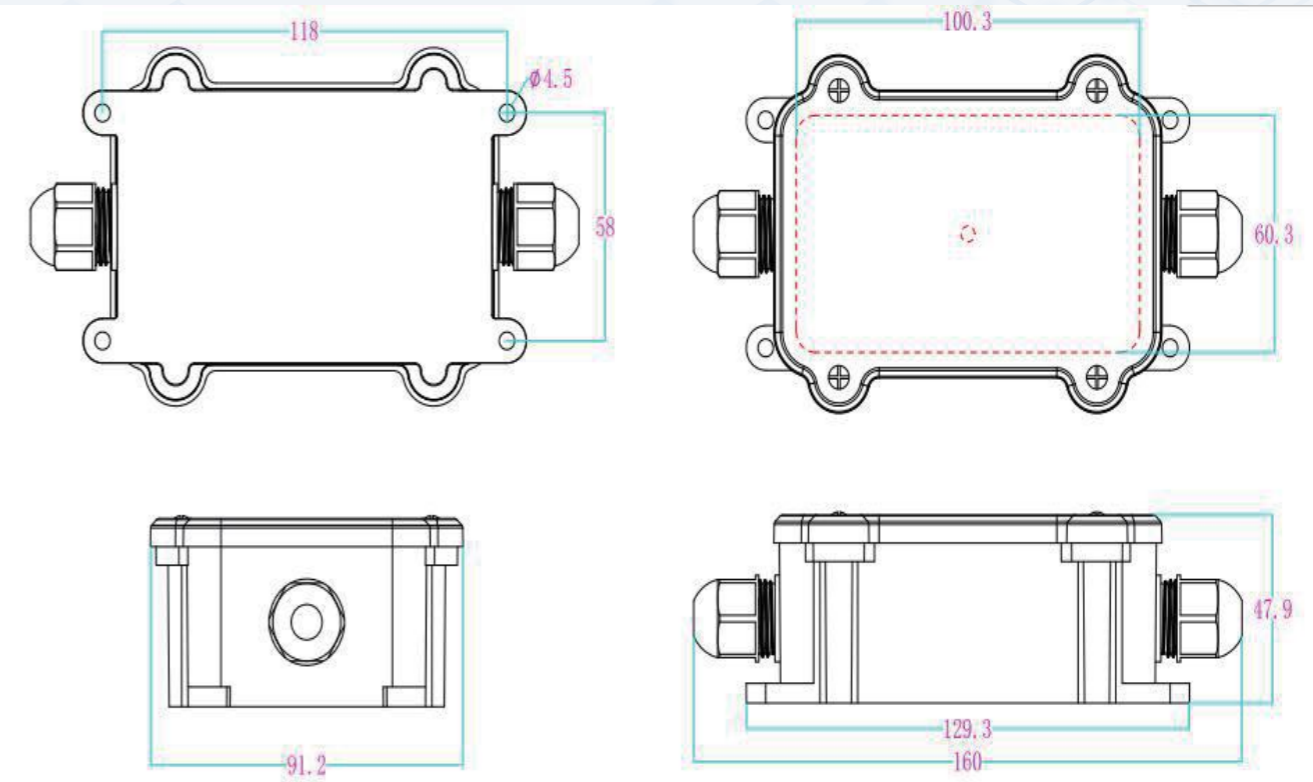

## IP68防水接线盒 IP68 waterproof junction box



### 型号: CDE107

Model

防水等级: IP68

Waterproof grade:

外壳材质: PC

Enclosure material:

外尺寸: 70\*70\*45mm

External dimension:

内尺寸: 60\*60\*37mm

Internal dimensions:

穿线孔径: 4-8mm/8-12mm

Threading hole diameter:

选配接头: PG13.5 M20-14

Optional join

适配电缆: 2x0.75<sup>2</sup>~3x4<sup>2</sup>

Adapter cable

### 型号: CDE106

Model

防水等级: IP68

Waterproof grade:

外壳材质: PC

Enclosure material:

外尺寸: 90\*90\*57mm

External dimension:

内尺寸: 80\*80\*49mm

Internal dimensions:

穿线孔径: 4-8mm/8-12mm/10-14mm

Threading hole diameter:

选配接头: PG7/PG9/PG13.5

Optional join

适配电缆: 2x0.75<sup>2</sup>~3x2.5<sup>2</sup>

Adapter cable

### 型号: CDE103-3Y

Model

防水等级: IP68

Waterproof grade:

外壳材质: PC

Enclosure material:

外尺寸: 105\*70.8\*38mm

External dimension:

内尺寸: 60\*50\*30mm

Internal dimensions:

穿线孔径: 5-8mm/8-12mm

Threading hole diameter:

适配电缆: 2x0.75<sup>2</sup>~3x2.5<sup>2</sup>

Adapter cable



## 金属透气阀 Metal vent valve



### 铝合金防水透气阀

防水 防尘 型号 齐全 螺纹 精准  
CE IP68



### 铝合金防水透气阀

防水 防尘 型号 齐全 螺纹 精准  
CE IP68



规格 Specifications	螺纹规格 Thread specification	螺纹外径AG Thread od AG	对边尺寸S Opposite side dimension	螺纹长度GL Thread length	透气量阻水压差 (10Kpa) Air permeability resistance water pressure difference	款式 style
M5	M5*0.8	4.7±0.2	8	8	160ml/min	单六角一字槽 Single hexagonal slot
M6	M6*1.0	5.7±0.2	10	5	170ml/min	
M8	M8*1.25	7.7±0.2	11	10	450ml/min	
M10	M10*1.5	9.7±0.2	16	8	800ml/min	
M12	M12*1.5	11.7±0.2	16	10	850ml/min	
M16	M16*1.5	15.7±0.2	18	7	1 400ml/min	
M20	M20*1.5	19.7±0.2	22	10	1500ml/min	

## 尼龙防水接头 Nylon waterproof joint



### PG-D型/PG-D Type

螺纹规格 Thread	适用电缆 Cable Range(mm)	螺纹外径 Threa O.D.L2(mm)	螺纹长度 Thread Length L2(mm)	扳手直径 Spanner Size A&E(mm)
PG7	4~6.5	12.5	9	19/16
PG9	4.5~8.5	15.2	9	22/19
PG11	5~10	18.6	9	24/22
PG13.5	6~11	20.4	10	26/24
PG16	8~13	22.5	10	30/27
PG21	13~18	28.3	12	36/33
PG29	18~25	37	12	46/42
PG36	23~32	47	15	56/52
PG42	30~38	54	18	65/60
PG48	37~44	59.3	18	69/68

### M-D型/M-D Type

螺纹规格 Thread	适用电缆 Cable Range(mm)	螺纹外径 Threa O.D.L2(mm)	螺纹长度 Thread Length L2(mm)	扳手直径 Spanner Size A&E(mm)
M8x1.25	2.5~4.5	8	7.5	13/12
M10x1.5	3~6	10	8	15/13
M12x1.5	4~6.5	12	9	17/16
M16x1.5	4.5~8.5	16	9	22/19
M18x1.5	5~10	18	9	24/22
M20x1.5	6~11	20	10	27/24
M22x1.5	8~13	22	10	29/27
M25x1.5	13~18	25	12	33/33
M28x1.5	13~18	28	12	35/33
M32x1.5	16~21	32	12	38/36
M36x1.5	18~25	36	12	45/42
M40x1.5	20~27	40	15	51/46
M46x1.5	23~32	46	15	53/52
M50x1.5	30~38	50	18	61/60
M63x1.5	37~44	60	18	71/68
M75x2	56~66	75	25	92/92
M90x2	66~77	90	25	111/110

## 铜镀镍防水接头 Copper nickel plated waterproof joint



### 公制螺纹M牙系类/Metric thread M series

螺纹规格 Thread	适用电缆 Cable Range (mm)	螺纹外径 Threa O.D.L2 (mm)	螺纹长度 Thread Length L2 (mm)	机扳口径 Spanner Size A&E (mm)	螺纹长度客 定制加长 Thread length(mm)	接线长度 G(Lmm) Thread length	扳手径 Spanner Size (mm)
M12X1.5	6.5~3	12	6	12-12.2	10	19	14/14
M14X1.5	8~4	14	7	14-14.2	10	19	16/18
M16X1.5	8~4	16	7	16-16.2	10	20	17/18
M18X1.5	10~6	18	7	18-18.2	10	21	20/21
M20X1.5	12~8	20	8	20-20.2	15	22	22/22
M22X1.5	14~10	22	8	22-22.2	15	23	24/24
M24X1.5	14~10	24	8	24-24.2	15	25	24/27
M25X1.5	14~10	25	8	25-25.2	15	25	24/27
	18~13	25	8	25-25.2	15	27	30/27
M27X1.5	18~13	27	8	27-27.2	15	27	30
M27X2	18~13	27	8	27-27.2	15	27	30
M28X1.5	18~13	28	8	28-28.2	15	27	30
M28X2	18~13	28	8	28-28.2	15	27	30
M30X1.5	18~13	30	8	30-30.2	15	29	30/34
M30X2	18~13	30	8	30-30.2	15	29	30/34
M32X1.5	22~15	32	9	32-32.2	15	29	34
M32X2	22~15	32	9	32-32.2	15	29	34
M33X1.5	22~15	33	9	33-33.2	15	29	34/36
M33X2	22~15	33	9	33-33.2	15	29	34/36
M36X1.5	25~18	36	9	36-36.2	15	31	40
M36X2	25~18	36	9	36-36.2	15	31	40
M37X1.5	25~18	37	9	37-37.2	15	31	40
M37X2	25~18	37	9	37-37.2	15	31	40
M40X1.5	25~18	40	10	40-40.2	15	31	43
	28~22	40	10	40-40.2	15	35	45

# 美规橡胶绝缘电线电缆

USA Standard Rubber Insulated Wire and Cable



高纯铜



高绝缘



高阻燃



耐弯折



长寿命

## 备注 | NOTE |

详细尺寸以产品规格书为准，型号规格可根据客户使用需求进行设计制造。

The product's detailed description please refer to the specification for approval, The types and specs could be customized by the request of clients.

## 美规橡胶绝缘电线电缆

UL HPN/HPN-R

### 产品用途 Application:

用于额定电压300V及以下动力装置、家用电器、电动工具、施工照明和机器内部等要求柔软或移动场所,作电气连接线或布线。  
The cables are used as electrical connected line or wiring in power installation, household appliances, electrically operated tools, construction lighting and machines inner rated voltage A.C 300V or below.

### 产品说明 Product Description:

- 型号: HPN/HPN-R  
Type: HPN/HPN-R
- 额定电压: 300V  
Rated Voltage: 300V
- 额定温度: 90°C&105°C  
Rated Temperature: 90°C&105°C
- 导体材料: 裸软铜绞线  
Conductor Material: Bare stranded copper
- 绝缘材料: 氯化聚乙烯  
Insulation Material: CPE
- 执行标准: UL62  
Executive Standard: UL62
- 绝缘颜色:  
Colour of insulation:  
三芯线: 黑色, 白色, 灰色  
3 cord: Black, White, Gray

### 产品结构图 Products Structural Drawing:



### 技术参数 Technical Parameter:

型号 Type	规格SPE. 芯线x截面mm <sup>2</sup> no.of cores x section	导体结构 Conductor constuction (No./mm)	绝缘厚度 Insulation thickness (mm)	护套厚度 Jacket thickness (mm)	参考外径 Over diamete! for reference (mm)	20°C导体直流电阻 Conductor D.C.resistance at 20°C (Ω/km)
HPN/HPN-R	18AWGx2C	4110.16	1.14	/	3.5+0.2x6.9+0.3	22.4
	18AWGx3C	4110.16	1.14/0.3(地)	/	3.7±0.2x9.1±0.3	22.4
	16AWGx2C	65/0.16	1.14	/	3.85±0.2x7.6±0.3	14.1
	16AWGx3C	65/0.16	1.14/0.3(地)	/	3.85+0.2x10.1±0.3	14.1
	14AWGx2C	104/0.16	1.52	/	4.9±0.2x9.8±0.3	8.88
	14AWGx3C	104/0.16	1.52/0.3(地)	/	4.9±0.2x12.5±0.3	8.88

# 欧规橡胶绝缘电线电缆

European Standard Rubber Insulated Wire and Cable



高纯铜



高绝缘



耐弯折



耐油性



耐气候

| 备注 | NOTE |

详细尺寸以产品规格书为准, 型号规格可根据客户使用需求进行设计制造。

The product's detailed description please refer to the specification for approval, The types and specs could be customized by the request of clients.

## 欧规橡胶绝缘电线电缆

H05RR-F

### 产品用途 Application:

用于额定电压300/500V及以下动力装置、家用电器、电动工具、施工照明和机器内部等要求柔软或移动场所,作电气连接线或布线。

The cables are used as electrical connected line or wiring in power installation, household appliances, electrically operated tools onstruction lighting and machines inner rated voltage A.C 300/500V or below.

### 产品说明 Product Description:

- 型号: H05RR-F  
Type: H05RR-F
- 额定电压: 300V/500V  
Rated Voltage: 300V/500V
- 额定温度: 960°C  
Rated Temperature: 60°C
- 导体材料: 裸软铜绞线  
Conductor Material: Bare stranded copper
- 绝缘材料: 氯化聚乙烯  
Insulation Material: CPE
- 执行标准: VDE 0282  
Executive Standard: VDE 0282
- 护套颜色: 黑色,白色,灰色  
Colour of jacket: Black,White,Gary
- 线芯颜色:  
Colour of insulation:  
二芯线:蓝色,棕色  
2 cord: Blue and Brown  
三芯线:黄/绿,蓝色,棕色  
3 cord: Yellow/Green,Blue and Brown  
四芯线:黄/绿,棕色,黑色,灰色  
4 cord: Yellow/Green,Brown,Black and Gary  
五芯线:黄/绿,蓝色,棕色,黑色,灰色  
5 cord:Yellow/Green,Blue,Brown,Black and Gary

### 产品结构图 Products Structural Drawing:



### 技术参数 Technical Parameter:

型号 Type	规格SPE. 芯线x截面mm <sup>2</sup> no.of cores x section	导体结构 Conductor constuction (No./mm)	绝缘厚度 Insulation thickness (mm)	护套厚度 Jacket thickness (mm)	参考外径 Over diamete! for reference (mm)	20°C导体直流电阻 Conductor D.C.resistance at 20°C (Ω/km)
H05RR-F	2x0.75	24/0.20	0.6	0.8	6.3±0.2	26.0
	2x1.0	32/0.20	0.6	0.9	6.7±0.2	19.5
	2x1.5	30/0.25	0.8	1.0	8.3±0.3	13.3
	2x2.5	49/0.25	0.9	1.1	10.0±0.3	7.98
	2x4.0	56/0.30	1.0	1.2	11.7±0.4	4.95
	3x0.75	24/0.20	0.6	0.9	6.8±0.2	26.0
	3x1.0	32/0.20	0.6	0.9	7.2±0.2	19.5
	3x1.5	30/0.25	0.8	1.0	8.9±0.3	13.3
	3x2.5	49/0.25	0.9	1.1	10.5±0.4	7.98
	3x4.0	56/0.30	1.0	1.2	12.4±0.4	4.95
	3x6.0	84/0.30	1.0	1.3	13.8±0.4	3.30
	4x0.75	24/0.20	0.6	0.9	7.5±0.3	26.0
	4x1.0	32/0.20	0.6	0.9	7.8±0.3	19.5
	4x1.5	30/0.25	0.8	1.1	9.9±0.3	13.3
	4x2.5	49/0.25	0.9	1.2	11.8±0.4	7.98
	4x4.0	56/0.30	1.0	1.3	13.8±0.4	4.95
	4x6.0	84/0.30	1.0	1.4	15.4±0.6	3.30
	5x0.75	24/0.20	0.6	1.0	8.4±0.3	26.0
	5x1.0	32/0.20	0.6	1.0	8.8±0.3	19.5
	5x1.5	30/0.25	0.8	1.1	10.8±0.4	13.3
5x2.5	49/0.25	0.9	1.3	13.2±0.5	7.98	
5x4.0	56/0.30	1.0	1.4	15.3±0.6	4.95	