

Model Name: P280HVN02.0

Issue Date : 2014/12/02

(*) Preliminary Specifications
() Final Specifications

Customer Signature	Date	AUO	Date
Approved By <hr/>		Approval By PM Director Kelly Kao <hr/>	<i>Kelly Kao</i>
Note		Reviewed By RD Director Eugene CC Chen <i>陳品川</i>	
		Reviewed By Project Leader Alex HM Chen <i>陳長慶</i>	
		Prepared By PM Travis Huang <i>Travis Huang</i>	

Contents

Record of Revision	4
1. General Description	5
3. Electrical Specification	7
3.1.1 Electrical Characteristics	7
3.1.2 AC Characteristics	7
3.1.3 Driver Characteristics	7
3.1.4 TCON Characteristics	8
3.2 Interface Connections	10
LVDS Option for 8bit	11
3.3 Signal Timing Specification	12
Timing Table (DE only Mode)	12
3.4 Signal Timing Waveforms	13
3.5 Color Input Data Reference	14
3.6 Power Sequence	15
3.7 Backlight Specification	16
3.7.1 Connector type:	16
3.7.2 Backlight Connector Dimension	16
3.7.3 Connector Pin Assignment	16
3.7.4 Absolute Maximum Rating	17
3.7.5 Recommended Operating Condition	17
3.7.6 Power Sequence for Backlight (LED)	19
4. Optical Specification	20
5. Mechanical Characteristics	23
Front View / Back View	24
6. Reliability Test Items	25
7. International Standard	26
7.1 Safety	26
7.2 EMC	26
8. Packing	27
8-1 DEFINITION OF LABEL:	27
B. Carton Label:	27
8-2 PACKING METHODS:	28
8-3 Pallet and Shipment Information	28
9. Precautions	29
9.1 Mounting Precautions	29
9.2 Operating Precautions	29

9.3	Operating Condition for Public Information Display	30
9.4	Electrostatic Discharge Control.....	30
9.5	Precautions for Strong Light Exposure.....	30
9.6	Storage.....	30
9.7	Handling Precautions for Protection Film.....	31

AUO Confidential For SYMMETRON Internal Use Only On 2015/07/16

1. General Description

This specification applies to the 28.0 inch Color TFT-LCD Module P280HVN02.0. This LCD module contains TFT active matrix type liquid crystal panel 1,920x358 pixels, and diagonal size of 28.0 inch. This module supports 1,920x358 mode. Each pixel is divided into Red, Green and Blue sub-pixels or dots which are arranged in vertical stripes. Gray scale or the brightness of the sub-pixel color is determined with a 8-bit gray scale signal for each dot. The P280HVN02.0 has been designed to apply the 8-bit 2 channel LVDS interface method. It is intended to support displays where high brightness, wide viewing angle, high color saturation, and high color depth.

* General Information

Items	Specification	Unit	Note
Active Screen Size	28.0	Inch	
Display Area	698.4(H) x 129.86(V)	mm	
Outline Dimension	733.78(H) x 165.34(V) x 17.9(D)	mm	1
Driver Element	a-Si TFT active matrix		
Display Colors	8 bit, 16.7M	Colors	
Number of Pixels	1,920x358	Pixel	3
Pixel Pitch	0.3637 (H) x 0.3637(W)	mm	
Pixel Arrangement	RGB vertical stripe		
Display Operation Mode	Normally Black		
Display Orientation	Landscape/Portrait Enable		
Surface Treatment	AG, Hardness 3H		Haze = 2%

Note:

- (1) D: 17.9 mm (front bezel to CB Cover)
- (2) LCD display as below illustrated when signal input with "ABC"
- (3) Active Timing (H) needs to be set as 1920*1080.

Rear side

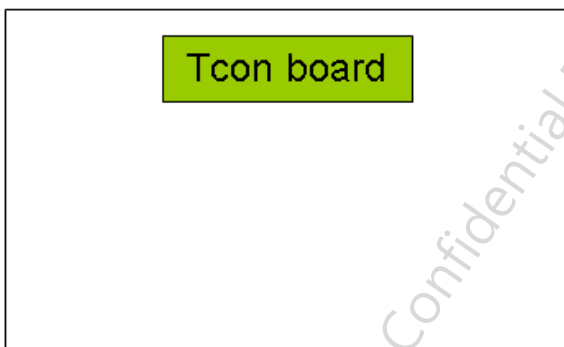

Front side

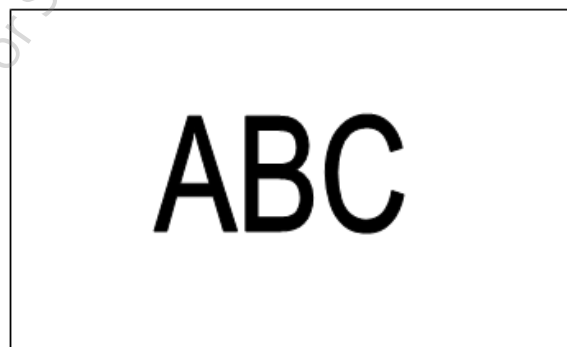

Absolute Maximum Ratings

The followings are maximum values which, if exceeded, may cause faulty operation or damage to the unit

Item	Symbol	Min	Max	Unit	Conditions
Logic/LCD Drive Voltage	Vcc	-0.3	14	[Volt]	Note 1
Input Voltage of Signal	Vin	-0.3	4	[Volt]	Note 1
Operating Temperature	TOP	0	+50	[°C]	Note 2
Operating Humidity	HOP	20	80	[%RH]	Note 2
Storage Temperature	TST	-20	+60	[°C]	Note 2
Storage Humidity	HST	20	80	[%RH]	Note 2
Panel Surface Temperature	PST		65	[°C]	Note 3

Note 1: Duration:50 msec.

Note 2 : Maximum Wet-Bulb should be 39 and No condensation.

The relative humidity must not exceed 90% non-condensing at temperatures of 40 or less. At temperatures greater than 40 , the wet bulb temperature must not exceed 39 .

Note 3: Surface temperature is measured at 50 Dry condition

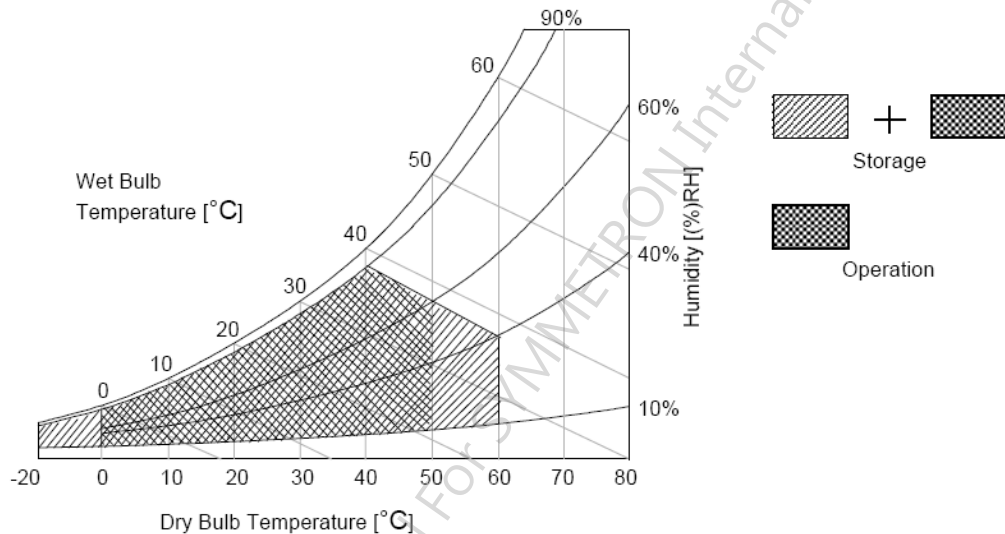

3. Electrical Specification

The LVDS input of P280HVN02.0 needs FHD input. The data input needs to be FHD.

3.1.1 Electrical Characteristics

Parameter		Symbol	Value			Unit	Note
			Min.	Typ.	Max		
LCD							
Power Supply Input Voltage		V_{DD}	10.8	12	13.2	V_{DC}	
Power Supply Input Current		I_{DD}	--	0.39	0.56	A	1
Power Consumption		P_C	--		5	Watt	1
Inrush Current		I_{RUSH}	-		4	A	2
Permissible Ripple of Power Supply Input Voltage (for input power=12V)		V_{RP}	--	--	$V_{DD} * 5\%$	mV_{pk-pk}	3
LVDS Interface	Input Differential Voltage	V_{ID}	200	400	600	mV_{DC}	4
	Differential Input High Threshold Voltage	V_{TH}	+100	--	+300	mV_{DC}	4
	Differential Input Low Threshold Voltage	V_{TL}	-300	--	-100	mV_{DC}	4
	Input Common Mode Voltage	V_{ICM}	1.1	1.25	1.4	V_{DC}	4
CMOS Interface	Input High Threshold Voltage	V_{IH} (High)	2.7	--	3.3	V_{DC}	7
	Input Low Threshold Voltage	V_{IL} (Low)	0	--	0.6	V_{DC}	
Backlight Power Consumption		P_{BL}	--	39.0		W	
Life Time(MTTF)			30000			--	8

3.1.2 AC Characteristics

Parameter		Symbol	Value			Unit	Note
			Min.	Typ.	Max		
LVDS Interface	Receiver Clock : Spread Spectrum Modulation range	F_{clk_ss}	F_{clk} -3%	--	F_{clk} +3%	MHz	9
	Receiver Clock : Spread Spectrum Modulation frequency	F_{ss}	30	--	200	KHz	9
	Receiver Data Input Margin Fclk = 85 MHz Fclk = 65 MHz	tRMG	-0.4 -0.5	-- --	0.4 0.5	ns	10

3.1.3 Driver Characteristics

Item	Symbol	Min	Max	Unit	condition
------	--------	-----	-----	------	-----------

Driver Surface Temperature	DST		100	[]	Note
----------------------------	-----	--	-----	-----	------

Note : Any point on the driver surface must be less than 100 under any conditions.

3.1.4 TCON Characteristics

Item	Symbol	Min	Max	Unit	condition
TCON Surface Temperature	TST		85	[]	Note

Note: Any point on the TCON surface must be less than 85 under any conditions.

Note :

1. Test Condition:

- (1) $V_{DD} = 12.0V$
- (2) $F_V =$ Type Timing, 60Hz, 120Hz or Other
- (3) $F_{CLK} =$ Max freq.
- (4) Temperature = 25
- (5) Test Pattern : White Pattern

2. Measurement condition : Rising time = 400us

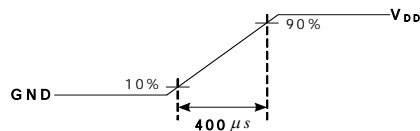

3. Test Condition:

- (1) The measure point of V_{RP} is in LCM side after connecting the System Board and LCM.
- (2) Under Max. Input current spec. condition.

4. $V_{ICM} = 1.25V$

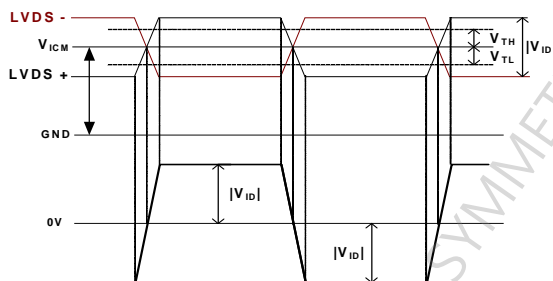

- 5. Do not attach a conducting tape to lamp connecting wire. If the lamp wire attach to conducting tape, TFT-LCD Module have a low luminance and the inverter has abnormal action because leakage current occurs between lamp wire and conducting tape.
- 6. The relative humidity must not exceed 80% non-condensing at temperatures of 40 or less. At temperatures greater than 40, the wet bulb temperature must not exceed 39. When operate at low temperatures, the brightness of LED will drop and the life time of LED will be reduced.
- 7. The measure points of V_{IH} and V_{IL} are in LCM side after connecting the System Board and LCM.
- 8. The lifetime (MTTF) is defined as the time which luminance of the LED is 50% compared to its original value. [Operating condition: Continuous operating at $T_a = 25 \pm 2$]

9. LVDS Receiver Clock SSCG (Spread spectrum clock generator) is defined as below figures

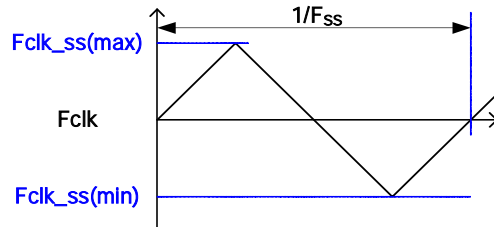

10. Receiver Data Input Margin

Parameter	Symbol	Rating			Unit	Note
		Min	Type	Max		
Input Clock Frequency	Fclk	Fclk (min)	--	Fclk (max)	MHz	$T=1/Fclk$
Input Data Position0	tRIP1	- tRMG	0	tRMG	ns	
Input Data Position1	tRIP0	$T/7- tRMG $	$T/7$	$T/7+ tRMG $	ns	
Input Data Position2	tRIP6	$2T/7- tRMG $	$2T/7$	$2T/7+ tRMG $	ns	
Input Data Position3	tRIP5	$3T/7- tRMG $	$3T/7$	$3T/7+ tRMG $	ns	
Input Data Position4	tRIP4	$4T/7- tRMG $	$4T/7$	$4T/7+ tRMG $	ns	
Input Data Position5	tRIP3	$5T/7- tRMG $	$5T/7$	$5T/7+ tRMG $	ns	
Input Data Position6	tRIP2	$6T/7- tRMG $	$6T/7$	$6T/7+ tRMG $	ns	

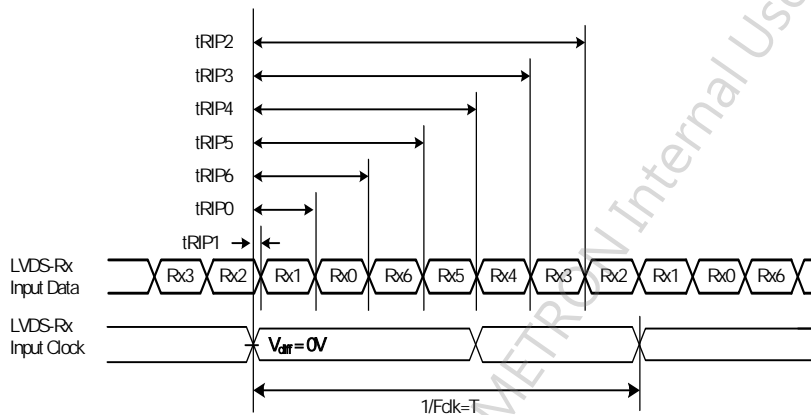

11. Please input the black signal after line 359 to avoid the unexpected image.

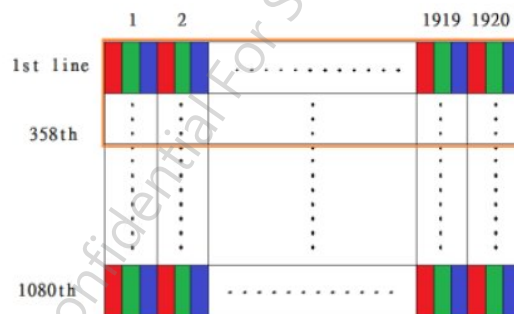

3.2 Interface Connections

● LCD connector : JAE FI-RE51S-HF (JAE)

PIN	Symbol	Description	PIN	Symbol	Description
1	Open	No connection (Internal Open)	26	GND	Ground
2	N.C.	AUO Internal Use Only	27	GND	Ground
3	N.C.	AUO Internal Use Only	28	CH2_0-	LVDS Channel 2, Signal 0-
4	N.C.	AUO Internal Use Only	29	CH2_0+	LVDS Channel 2, Signal 0+
5	N.C.	AUO Internal Use Only	30	CH2_1-	LVDS Channel 2, Signal 1-
6	N.C.	AUO Internal Use Only	31	CH2_1+	LVDS Channel 2, Signal 1+
7	LVDS_SEL	Open/High(3.3V) for NS, Low(GND) for JEIDA	32	CH2_2-	LVDS Channel 2, Signal 2-
8	N.C.	No connection	33	CH2_2+	LVDS Channel 2, Signal 2+
9	N.C.	No connection	34	GND	Ground
10	GND	Ground	35	CH2_CLK-	LVDS Channel 2, Clock -
11	GND	Ground	36	CH2_CLK+	LVDS Channel 2, Clock +
12	CH1_0-	LVDS Channel 1, Signal 0-	37	GND	Ground
13	CH1_0+	LVDS Channel 1, Signal 0+	38	CH2_3-	LVDS Channel 2, Signal 3-
14	CH1_1-	LVDS Channel 1, Signal 1-	39	CH2_3+	LVDS Channel 2, Signal 3+
15	CH1_1+	LVDS Channel 1, Signal 1+	40	N.C.	AUO Internal Use Only
16	CH1_2-	LVDS Channel 1, Signal 2-	41	N.C.	AUO Internal Use Only
17	CH1_2+	LVDS Channel 1, Signal 2+	42	GND	Ground
18	GND	Ground	43	GND	Ground
19	CH1_CLK-	LVDS Channel 1, Clock -	44	GND	Ground
20	CH1_CLK+	LVDS Channel 1, Clock +	45	GND	Ground
21	GND	Ground	46	GND	Ground
22	CH1_3-	LVDS Channel 1, Signal 3-	47	N.C.	No connection
23	CH1_3+	LVDS Channel 1, Signal 3+	48	V _{DD}	Power Supply, +12V DC Regulated
24	N.C.	AUO Internal Use Only	49	V _{DD}	Power Supply, +12V DC Regulated
25	N.C.	AUO Internal Use Only	50	V _{DD}	Power Supply, +12V DC Regulated
			51	V _{DD}	Power Supply, +12V DC Regulated

Note 1: All GND (ground) pins should be connected together and should also be connected to the LCD's metal frame.

Note 2: All V_{DD} (power input) pins should be connected together.

Note 3: All NC (no connection) pins please leave this pin unoccupied. It can not be connected by any signal (Low/GND/High).

LVDS Option for 8bit

LVDS Option = High/Open → NS

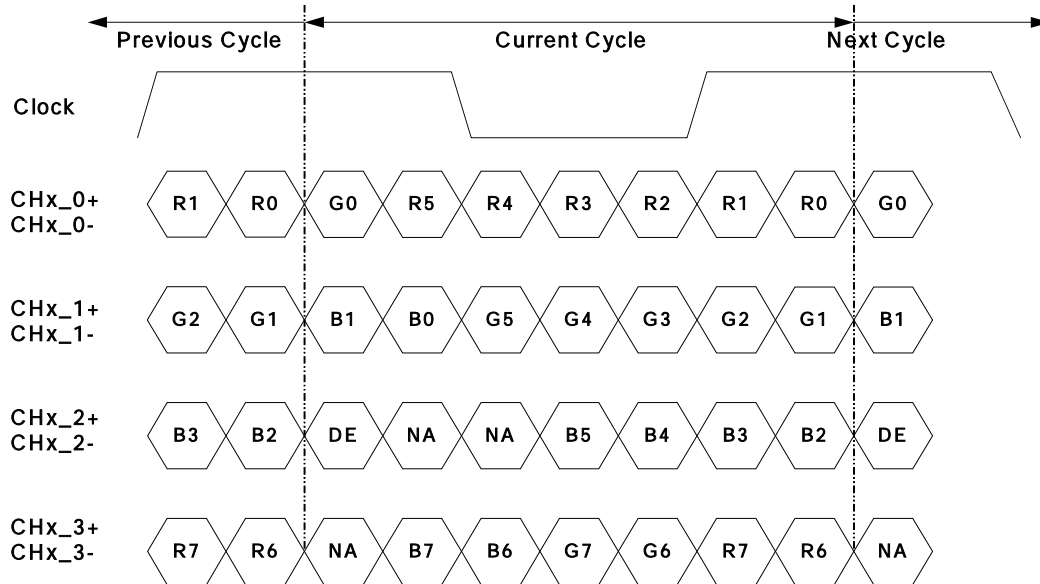

Note: x = 1, 2, 3, 4...

LVDS Option = Low → JEIDA

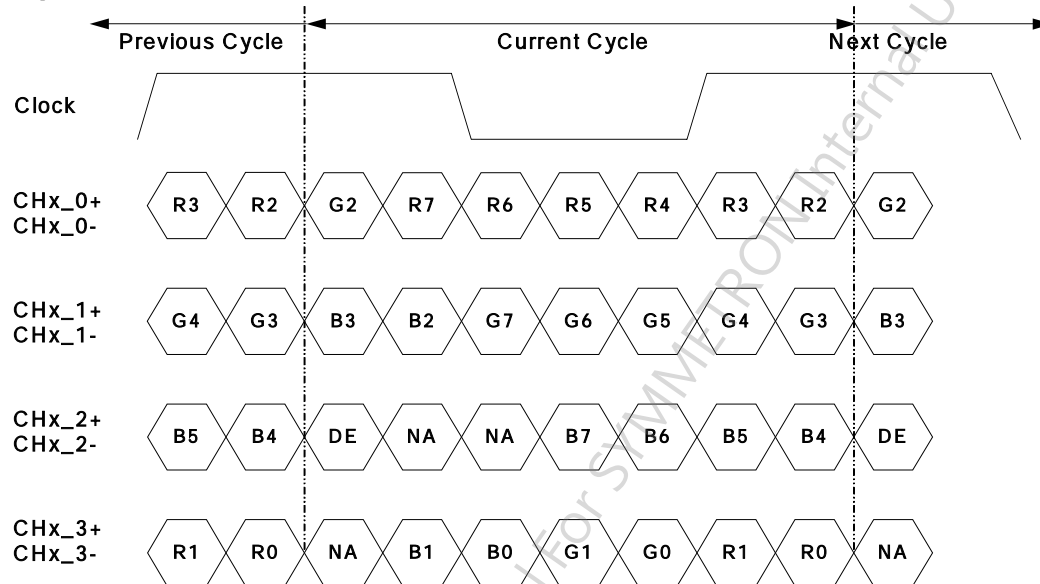

Note: x = 1, 2, 3, 4...

3.3 Signal Timing Specification

This is the signal timing required at the input of the user connector. All of the interface signal timing should be satisfied with the following specifications for its proper operation.

Timing Table (DE only Mode)

Vertical Frequency Range (60Hz)

Signal	Item	Symbol	Min.	Typ.	Max	Unit
Vertical Section	Period	Tv	1096	1125	1480	Th
	Active	Tdisp (v)	1080			Th
	Blanking	Tblk (v)	16	45	400	Th
Horizontal Section	Period	Th	1030	1100	1325	Tclk
	Active	Tdisp (h)	960			Tclk
	Blanking	Tblk (h)	70	140	368	Tclk
Clock	Frequency	Fclk=1/Tclk	50	74.25	82	MHz
Vertical Frequency	Frequency	Fv	47	60	63	Hz
Horizontal Frequency	Frequency	Fh	60	67.5	73	KHz

Notes:

(1) Display position is specific by the rise of DE signal only.

Horizontal display position is specified by the rising edge of 1st DCLK after the rise of 1st DE, is displayed on the left edge of the screen.

(2) Vertical display position is specified by the rise of DE after a "Low" level period equivalent to eight times of horizontal period. The 1st data corresponding to one horizontal line after the rise of 1st DE is displayed at the top line of screen.

(3) If a period of DE "High" is less than 1920 DCLK or less than 358 lines, the rest of the screen displays black.

(4) The display position does not fit to the screen if a period of DE "High" and the effective data period do not synchronize with each other.

3.4 Signal Timing Waveforms

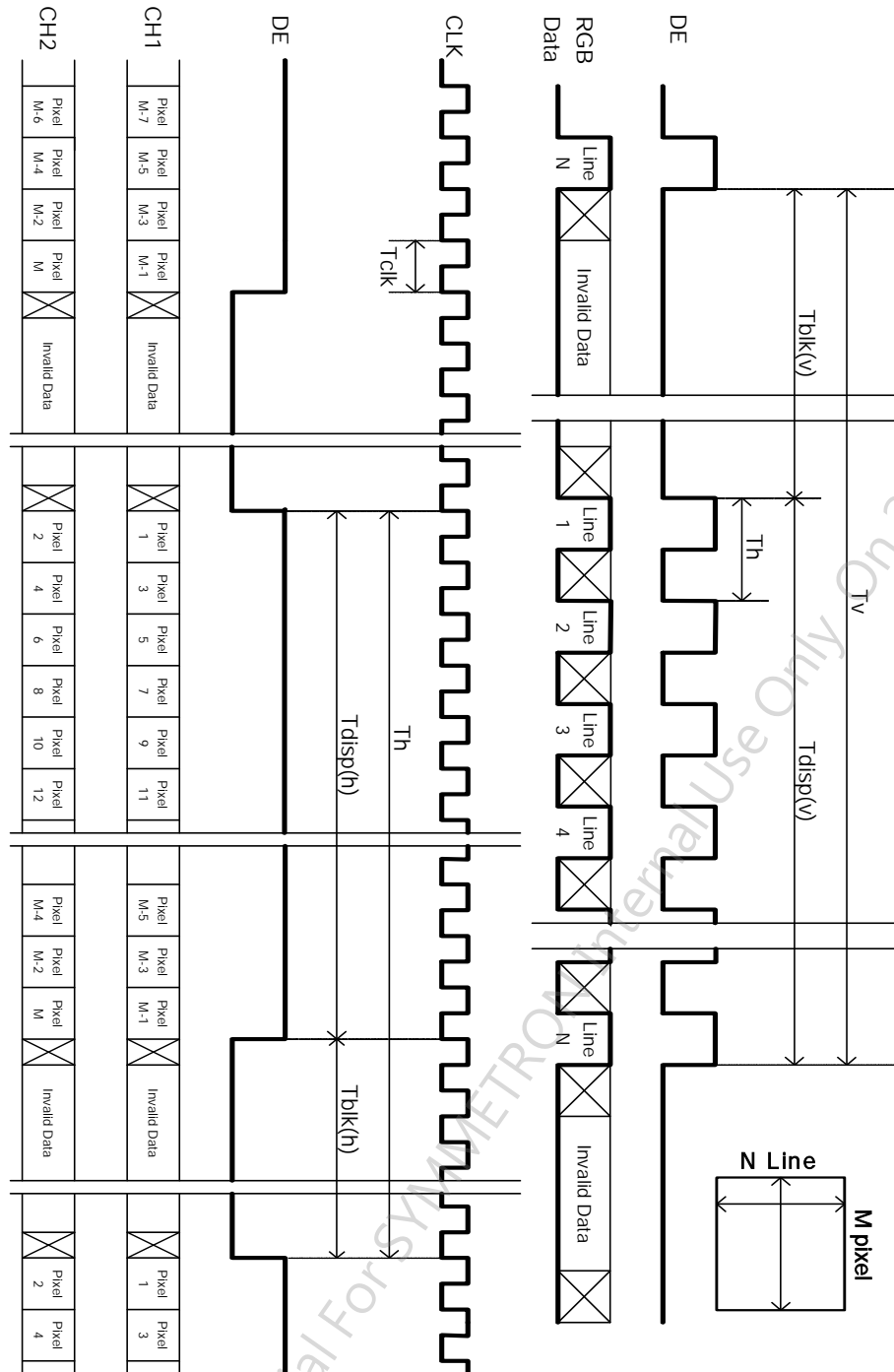

3.5 Color Input Data Reference

The brightness of each primary color (red, green and blue) is based on the 10 bit gray scale data input for the color; the higher the binary input, the brighter the color. The table below provides a reference for color versus data input.

COLOR DATA REFERENCE

Color		Input Color Data																							
		RED								GREEN								BLUE							
		MSB				LSB				MSB				LSB				MSB				LSB			
		R7	R6	R5	R4	R3	R2	R1	R0	G7	G6	G5	G4	G3	G2	G1	G0	B7	B6	B5	B4	B3	B2	B1	B0
Basic Color	Black	0	0	0	0	0	0	0	0	0	0	0	0	0	0	0	0	0	0	0	0	0	0	0	0
	Red(255)	1	1	1	1	1	1	1	1	0	0	0	0	0	0	0	0	0	0	0	0	0	0	0	0
	Green(255)	0	0	0	0	0	0	0	0	1	1	1	1	1	1	1	1	0	0	0	0	0	0	0	0
	Blue(255)	0	0	0	0	0	0	0	0	0	0	0	0	0	0	0	0	1	1	1	1	1	1	1	1
	Cyan	0	0	0	0	0	0	0	0	1	1	1	1	1	1	1	1	1	1	1	1	1	1	1	1
	Magenta	1	1	1	1	1	1	1	1	0	0	0	0	0	0	0	0	1	1	1	1	1	1	1	1
	Yellow	1	1	1	1	1	1	1	1	1	1	1	1	1	1	1	1	0	0	0	0	0	0	0	0
	White	1	1	1	1	1	1	1	1	1	1	1	1	1	1	1	1	1	1	1	1	1	1	1	1
R	RED(000)	0	0	0	0	0	0	0	0	0	0	0	0	0	0	0	0	0	0	0	0	0	0	0	0
	RED(001)	0	0	0	0	0	0	0	1	0	0	0	0	0	0	0	0	0	0	0	0	0	0	0	0

	RED(254)	1	1	1	1	1	1	1	0	0	0	0	0	0	0	0	0	0	0	0	0	0	0	0	0
	RED(255)	1	1	1	1	1	1	1	1	0	0	0	0	0	0	0	0	0	0	0	0	0	0	0	0
G	GREEN(000)	0	0	0	0	0	0	0	0	0	0	0	0	0	0	0	0	0	0	0	0	0	0	0	0
	GREEN(001)	0	0	0	0	0	0	0	0	0	0	0	0	0	0	0	1	0	0	0	0	0	0	0	0

	GREEN(254)	0	0	0	0	0	0	0	0	1	1	1	1	1	1	1	0	0	0	0	0	0	0	0	0
	GREEN(255)	0	0	0	0	0	0	0	0	1	1	1	1	1	1	1	1	0	0	0	0	0	0	0	0
B	BLUE(000)	0	0	0	0	0	0	0	0	0	0	0	0	0	0	0	0	0	0	0	0	0	0	0	0
	BLUE(001)	0	0	0	0	0	0	0	0	0	0	0	0	0	0	0	0	0	0	0	0	0	0	0	1

	BLUE(254)	0	0	0	0	0	0	0	0	0	0	0	0	0	0	0	0	1	1	1	1	1	1	1	0
	BLUE(255)	0	0	0	0	0	0	0	0	0	0	0	0	0	0	0	0	1	1	1	1	1	1	1	1

3.6 Power Sequence

◆ Power Sequence of LCD

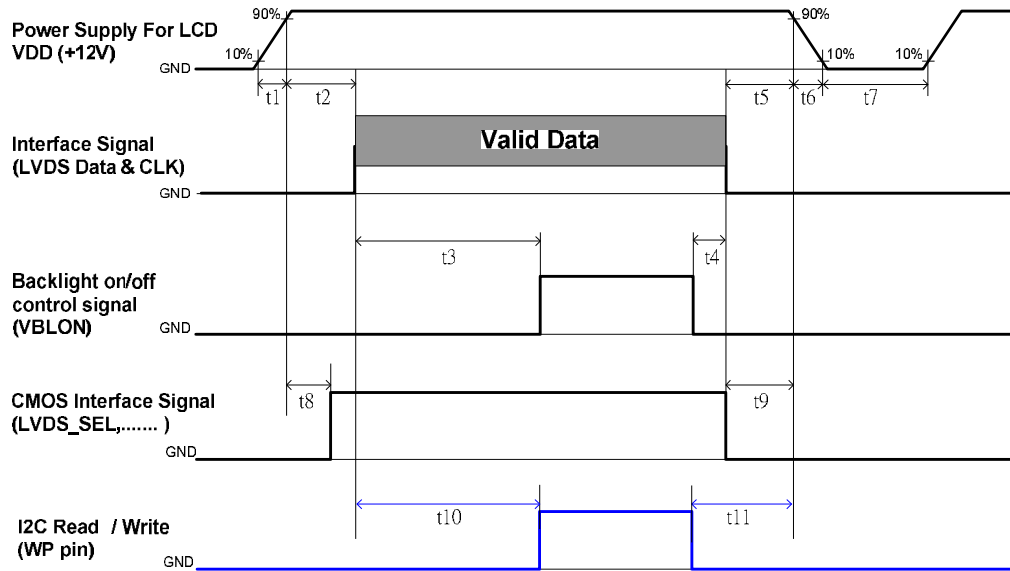

Parameter	Values			Unit
	Min.	Type.	Max.	
t1	0.4	---	30	ms
t2	0.1	---	50	ms
t3	450	---	---	ms
t4	0 ^{*1}	---	---	ms
t5	0	---	---	ms
t6	---	---	---	ms
t7	500	---	---	ms
t8	10 ^{*3}	---	50	ms
t9	0	---	---	ms
t10	450	---	---	ms
t11	150	---	---	ms

Note:

- (1) t4=0 : concern for residual pattern before BLU turn off.
- (2) t6 : voltage of VDD must decay smoothly after power-off. (customer system decide this value)
- (3) When CMOS Interface signal is N.C. (no connection), opened in Transmitted end, t8 timing spec can be negligible.

3.7 Backlight Specification

The backlight unit contains 76pcs LED. It includes two LED light bars and each light bar contains 38pcs LED. (4strings and 19pcs LED of each string)

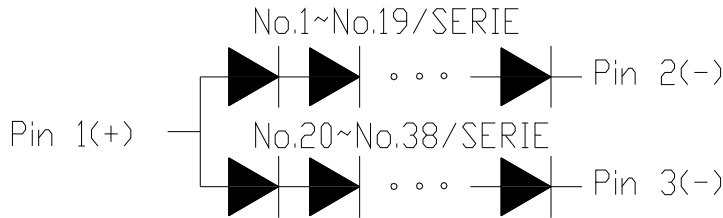

3.7.1 Connector type:

Backlight Connector	Manufacturer	ENTERYor compatible
	Connector Model Number	3707K-S03N-04L
Mating Connector	Manufacturer	ENTERYor compatible
	Connector Model Number	H112K-D03N-20B

3.7.2 Backlight Connector Dimension

Hx Vx D = 4.9x2.6x4.25 Pitch=1.0 (unit=mm)

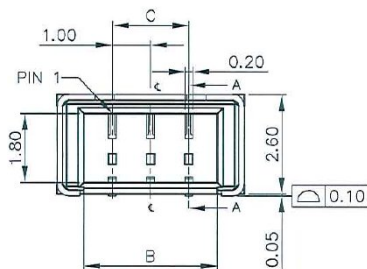

3.7.3 Connector Pin Assignment

PIN NO.	SYMBOL	FUNCTION
1	Va(1)	LED Anode (Positive)
2	Vc(1)	LED Cathode (Negative)
3	Vc(2)	LED Cathode (Negative)

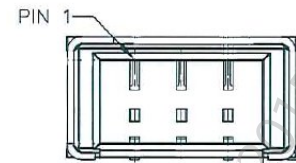
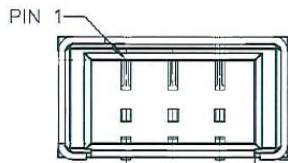
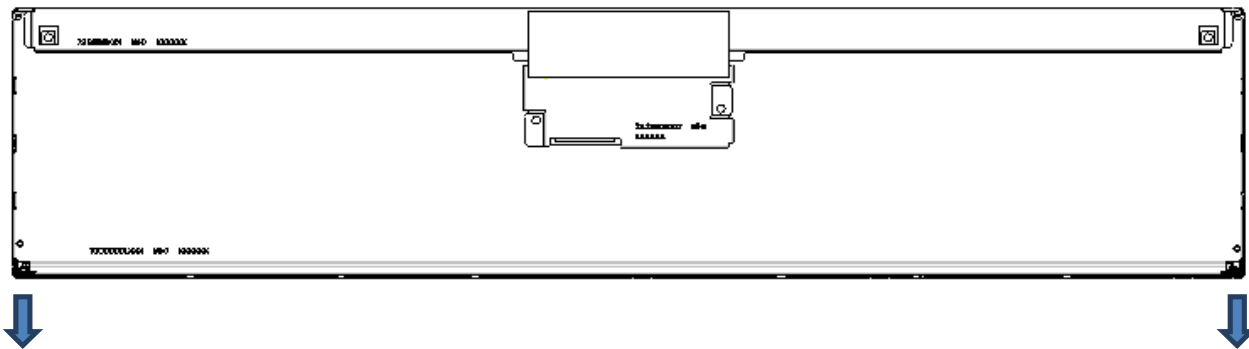

3.7.4 Absolute Maximum Rating

Symbol	Description	Min	Max	Unit	Remark
Is	LED String Current	0	150	mA	100% Duty Ratio
			300	mA	Duty Ratio 10% Pulse Time = 10ms

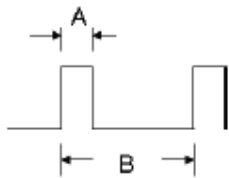

Duty ratio= (A / B) X 100% ; (A: Pulse time, B: Period)

3.7.5 Recommended Operating Condition

Symbol	Description	Min.	Typ.	Max.	Unit	Remark
Is	LED String Current	-	120	-	mA	100% Duty ratio of LED Chip
Vs	LED String Voltage	57	62.7	68.4	Volt	Note 3-1 and Note 3-5
Vs	Maximum Vs Voltage Deviation of light bar	-	-	1.9	Volt	Note 3-2
P _{BLU}	LED Light Bar Power Consumption	-	30.1	32.8	Watt	Note 3-3
LT _{LED}	LED Life Time	30000	-	-	Hour	Note 3-4
OVP	Over Voltage Protection in system board	75.2	-	-	Volt	Note 3-5

Note 3-1:

V_s (Typ.) = V_F (Typ.) X LED No. (one string);

- a. V_F : LED chip forward voltage, V_F (Min.)=3.0V, V_F (Typ.)=3.3V, V_F (Max.)=3.6V
- b. The same equation to calculate V_s (Min.) & V_s (Max.) for respective V_F (Min.) & V_F (Max.);

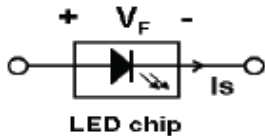

Note 3-2:

ΔV_s (Max.) = ΔV_F X LED No. (one string);

- a. ΔV_F : LED chip forward voltage deviation (0.2V , each Bin of LED V_F)

Note 3-3:

P_{BLU} (Typ.) = V_s (Typ.) X I_s (Typ.) X 4 (4 is total String No. of BLU)

P_{BLU} (Max.) = V_s (Max.) X I_s (Typ.) X 4

Note 3-4:

Definition of life time:

- a. Brightness of LED becomes to 50% of its original value
- b. Test condition: I_s = 120mA and 25 (Room Temperature)

Note 3-5:

Recommendation for LED driver power design:

Due to there are electrical property deviation in LED & monitor set system component after long time operation. AUO strongly recommend the design value of LED driver board OVP (over voltage protection) should be 10% higher than max. value of LED string voltage (V_s) at least.

Note 3-6:

AUO strongly recommend “Analog Dimming” method for backlight brightness control for Wavy Noise Free. Otherwise, recommend that Dimming Control Signal (PWM Signal) should be synchronized with Frame Frequency

3.7.6 Power Sequence for Backlight (LED)

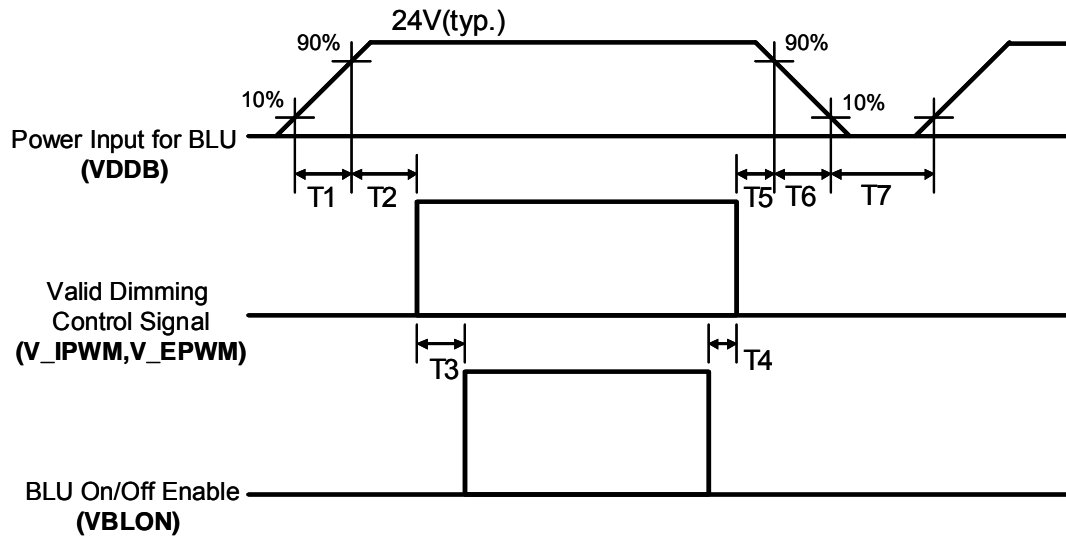

Dip condition

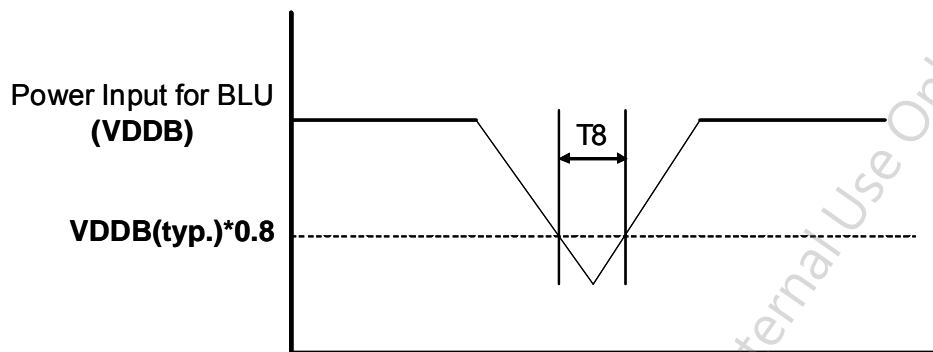

Parameter	Value			Units
	Min	Typ	Max	
T1	20	-	-	ms ⁻¹
T2 (Normal)	500	-	-	ms
T3 (Normal)	250	-	-	ms
T4	0	-	-	ms
T5	1	-	-	ms
T6	-	-	-	ms
T8	-	-	10	Ms

4. Optical Specification

Optical characteristics are determined after the unit has been 'ON' and stable for approximately 45 minutes in a dark environment at 25°C while panel is placed in the default position. The default position is T-con side as the up side of panel. The value specified is at an approximate distance 50cm from the LCD surface at a viewing angle of φ and θ equal to 0°.

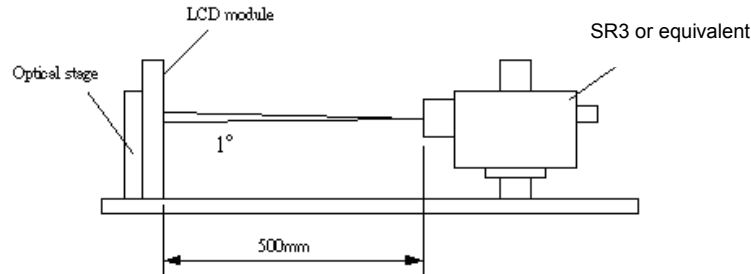

Parameter	Symbol	Values			Unit	Notes	
		Min.	Typ.	Max			
Contrast Ratio	CR	2400	3000	--		1	
Surface Luminance (White)	L _{WH}	560	700	--	cd/m ²	2	
Luminance Variation	$\delta_{\text{WHITE}(9P)}$	--	--	1.33		3	
Response Time (G to G)	T _Y	--	6.5	10	Ms	4	
Color Gamut	NTSC	68	72		%		
Color Coordinates							
Red	R _X	Typ.-0.03	0.630	Typ.+0.03			
	R _Y		0.331				
Green	G _X		0.294				
	G _Y		0.622				
Blue	B _X		0.151				
	B _Y		0.049				
White	W _X		0.254				
	W _Y	0.276					
Viewing Angle							
x axis, right($\varphi=0^\circ$)	θ_r	--	89	--	degree	5	
	θ_l	--	89	--	degree		
	y axis, up($\varphi=90^\circ$)	θ_u	--	89	--		degree
	y axis, down ($\varphi=270^\circ$)	θ_d	--	89	--		degree

Note:

1. Contrast Ratio (CR) is defined mathematically as:

$$\text{Contrast Ratio} = \frac{\text{Surface Luminance of } L_{\text{On5}}}{\text{Surface Luminance of } L_{\text{Off5}}}$$

- Surface luminance is luminance value at point 5 across the LCD surface 50cm from the surface with all pixels displaying white. From more information see FIG 2. $L_{WH} = L_{on5}$ where L_{on5} is the luminance with all pixels displaying white at center 5 location.
- The variation in surface luminance, δ_{WHITE} is defined (center of Screen) as:

$$\delta_{WHITE(9P)} = \text{Maximum}(L_{on1}, L_{on2}, \dots, L_{on9}) / \text{Minimum}(L_{on1}, L_{on2}, \dots, L_{on9})$$
- Response time T is the average time required for display transition by switching the input signal for five luminance ratio (0%,25%,50%,75%,100% brightness matrix) and is based on $F_v=60\text{Hz}$ to optimize.

Measured Response Time		Target				
		0%	25%	50%	75%	100%
Start	0%		0% to 25%	0% to 50%	0% to 75%	0% to 100%
	25%	25% to 0%		25% to 50%	25% to 75%	25% to 100%
	50%	50% to 0%	50% to 25%		50% to 75%	50% to 100%
	75%	75% to 0%	75% to 25%	75% to 50%		75% to 100%
	100%	100% to 0%	100% to 25%	100% to 50%	100% to 75%	

- Viewing angle is the angle at which the contrast ratio is greater than 10. The angles are determined for the horizontal or x axis and the vertical or y axis with respect to the z axis which is normal to the LCD surface. For more information see FIG4.

FIG. 2 Luminance

Definition of White Variation (W):

Measure the luminance of gray level 255 at 3 points

$$W = \text{Maximum} [L (1), L (2), L (3)] / \text{Minimum} [L (1), L (2), L (3)]$$

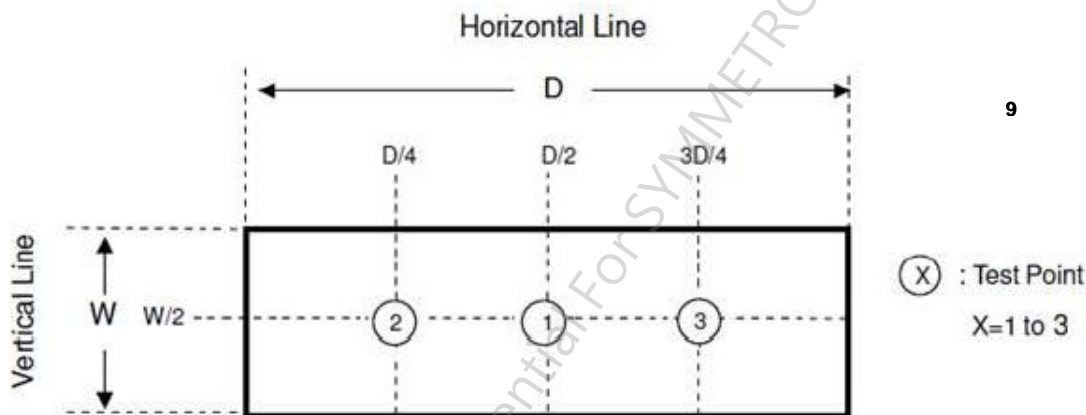
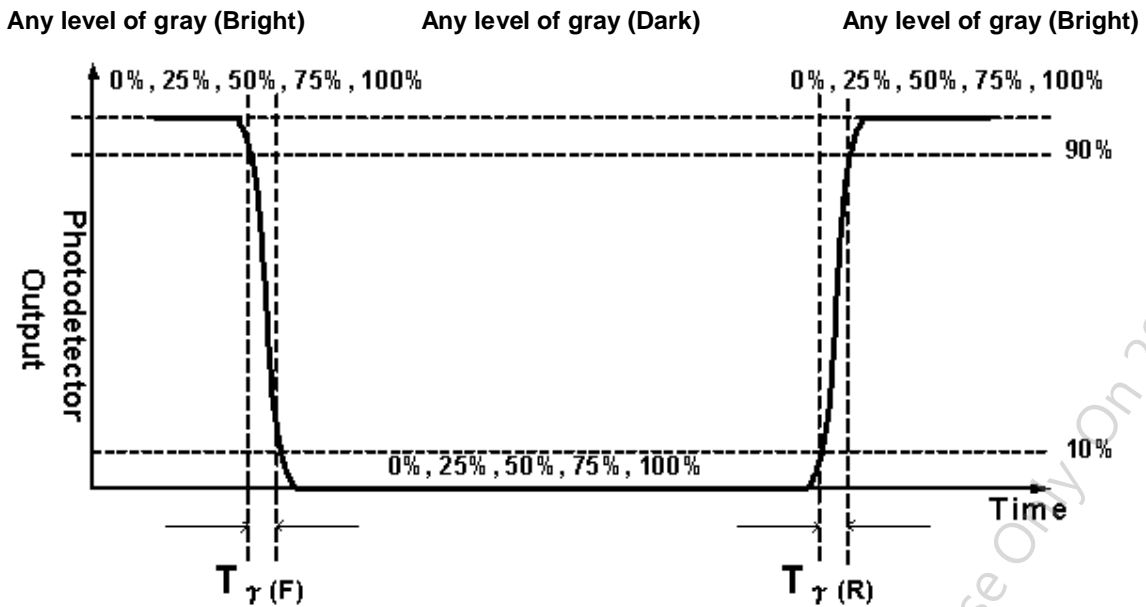
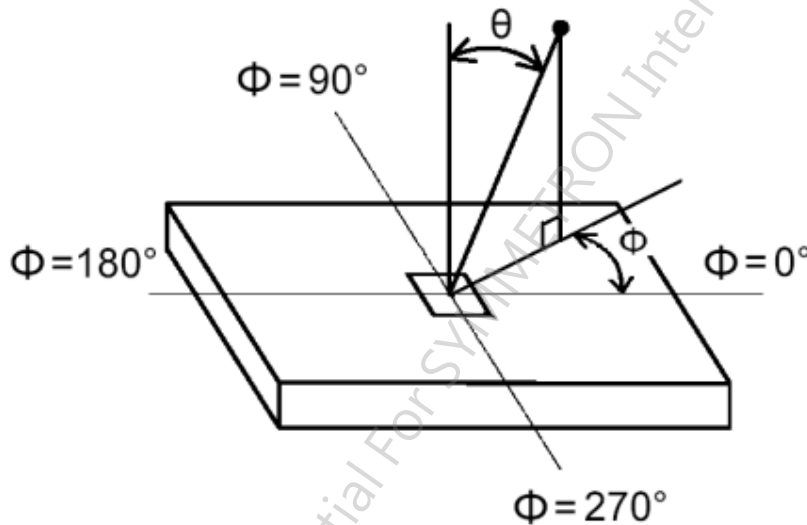

FIG.3 Response Time

The response time is defined as the following figure and shall be measured by switching the input signal for “any level of gray(bright)” and “any level of gray(dark)”.



6. FIG.4 Viewing Angle



5. Mechanical Characteristics

The contents provide general mechanical characteristics for the model P280HVN02.0. In addition the figures in the next page are detailed mechanical drawing of the LCD.

Outline Dimension	Horizontal (typ.)	733.78 mm
	Vertical (typ.)	165.43 mm
	Depth (typ.)	17.9 mm
Bezel Opening Area	Horizontal (typ.)	702.4 mm
	Vertical (typ.)	133.86 mm
Active Display Area	Horizontal	698.4 mm
	Vertical	129.86 mm
Weight	Typ 1100g	

5.1 Placement suggestions:

The Suggestion placement is as following:

1. Landscape mode: The default placement is T-Con Side as the top side.
2. Portrait mode: The default placement is T-Con side has to be placed in the right side via viewing from the front.

Landscape (Front view)

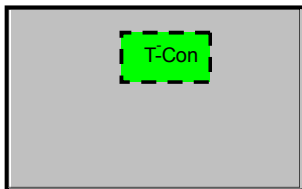

Portrait (Front view)

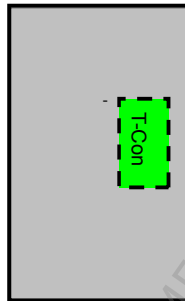

6. Reliability Test Items

	Test Items	Q'ty	Condition
1	High Temperature Storage	3 pcs	60 , 300hrs
2	Low Temperature Storage	3 pcs	-20 , 300hrs
3	High Temperature Operation	3 pcs	50 , 300hrs
4	Low Temperature Operation	3 pcs	-5 , 300hrs

AUO Confidential For SYMMETRON Internal Use Only On 2015/07/16

7. International Standard

7.1 Safety

(1) UL60950-1, 2nd Ed., Underwriters Laboratories, (AUO file number: E204356)

Standard for safety of information technology equipment including electrical business equipment

(2) IEC 60950-1

(3) EN60950-1

European Committee for Electro technical Standardization (CENELEC)

European Standard for safety of information technology equipment including electrical business equipment

7.2 EMC

(1) ANSI C63.4 "Methods of Measurement of Radio-Noise Emissions from Low-Voltage Electrical and Electrical Equipment in the Range of 9kHz to 40GHz." American National standards Institute(ANSI), 1992

(2) C.I.S.P.R "Limits and Methods of Measurement of Radio Interface Characteristics of Information Technology Equipment." International Special committee on Radio Interference.

(3) EN 55022 "Limits and Methods of Measurement of Radio Interface Characteristics of Information Technology Equipment." European Committee for Electro technical Standardization. (CENELEC), 1998



8. Packing

8-1 DEFINITION OF LABEL:

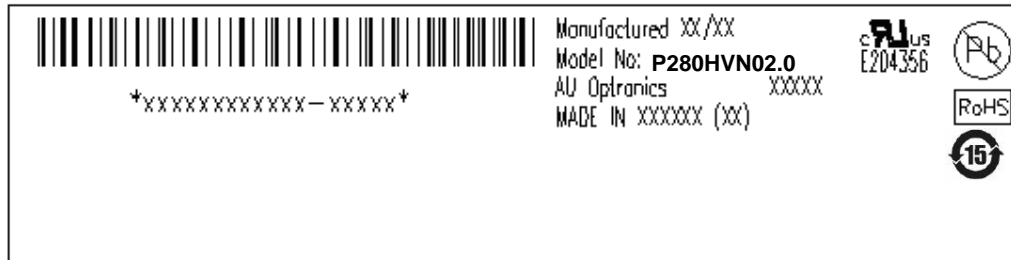
A. Panel Label:



Green mark description

- (1) For Pb Free Product, AUO will add  for identification.
- (2) For RoHs compatible products, AUO will add  for identification.

Note: The green Mark will be present only when the green documents have been ready by AUO internal green team. (definition of green design follows the AUO green design checklist.)

B. Carton Label:

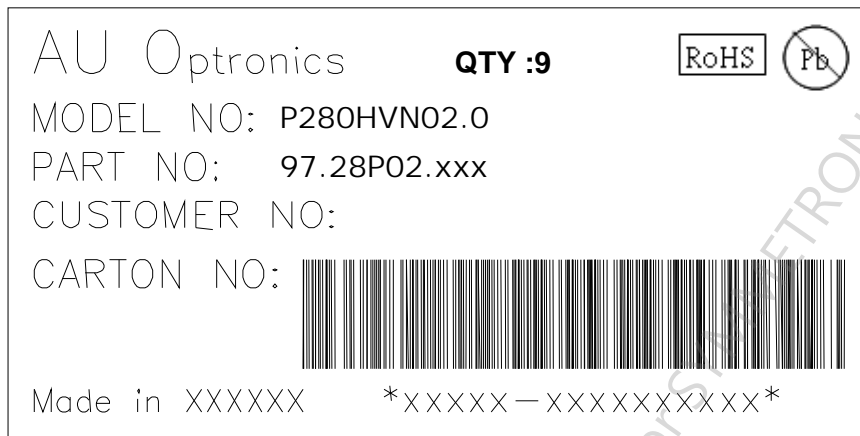

8-2 PACKING METHODS:

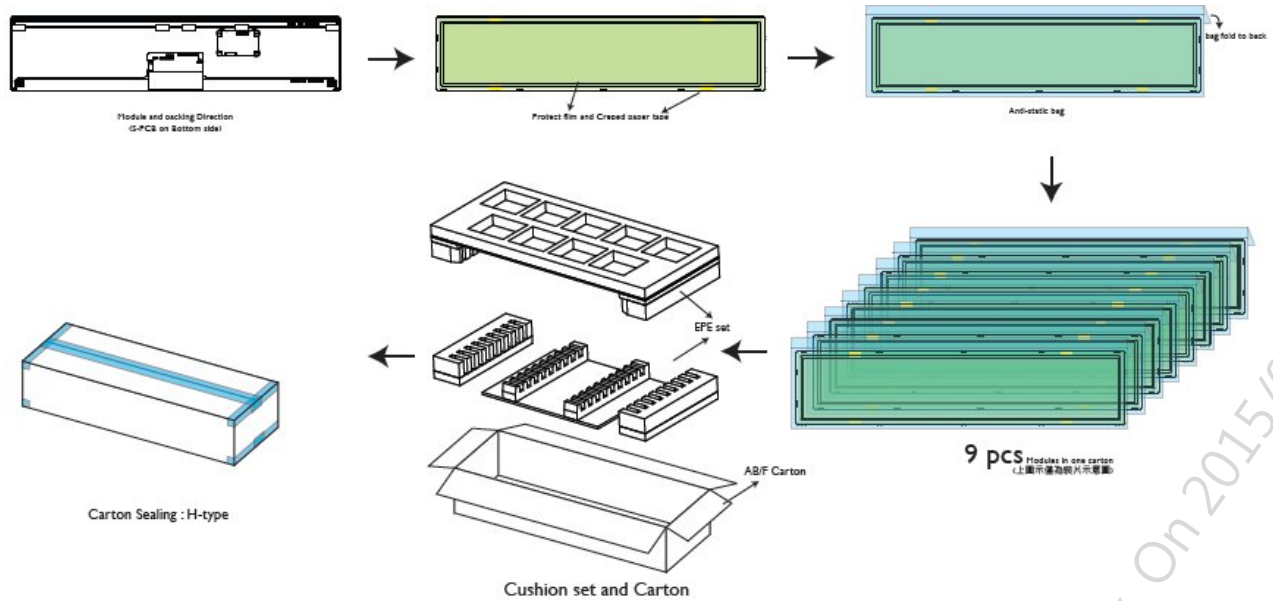

8-3 Pallet and Shipment Information

Item	Specification			Packing Remark Qty.
	Qty.	Dimension	Total Weight (kg)	
Packing BOX	9pcs/box	832(L)*368(W)*265(H)	11.5kg	9pcs/box Cushion = 2.5kg (Includes bottom cardboard)
Pallet	1	1150(L)*845(W)*132(H)	Pallet	1
Boxes per Pallet	24 Boxes /pallet			
Panels per Pallet	216 pcs /pallet			

9. Precautions

Please pay attention to the followings when you use this TFT LCD module.

9.1 Mounting Precautions

- (1) You must mount a module using holes arranged in four corners or four sides.
- (2) You should consider the mounting structure so that uneven force (ex. twisted stress) is not applied to module. And the case on which a module is mounted should have sufficient strength so that external force is not transmitted directly to the module.
- (3) Please attach the surface transparent protective plate to the surface in order to protect the polarizer. Transparent protective plate should have sufficient strength in order to resist external force.
- (4) You should adopt radiation structure to satisfy the temperature specification.
- (5) Acetic acid type and chlorine type materials for the cover case are not desirable because the former generates corrosive gas of attacking the polarizer at high temperature and the latter cause circuit broken by electro-chemical reaction.
- (6) Do not touch, push or rub the exposed polarizer with glass, tweezers or anything harder than HB pencil lead. And please do not rub with dust clothes with chemical treatment. Do not touch the surface of polarizer for bare hand or greasy cloth. (Some cosmetics are detrimental to the polarizer.)
- (7) When the surface becomes dusty, please wipe gently with absorbent cotton or other soft materials like chamois soaks with petroleum benzene. Normal-hexane is recommended for cleaning the adhesives used to attach front/ rear polarizer. Do not use acetone, toluene and alcohol because they cause chemical damage to the polarizer.
- (8) Wipe off saliva or water drops as soon as possible. Their long time contact with polarizer causes deformations and color fading.
- (9) Do not open the case because inside circuits do not have sufficient strength.

9.2 Operating Precautions

- (1) The spike noise causes the mis-operation of circuits. It should be lower than following voltage:
 $V = \pm 200\text{mV}$ (Over and under shoot voltage)
- (2) Response time depends on the temperature. (In lower temperature, it becomes longer..)
- (3) Brightness depends on the temperature. (In lower temperature, it may become lower.) And in lower temperature, response time (required time that brightness is stable after turned on) becomes longer.
- (4) Be careful for condensation at sudden temperature change. Condensation makes damage to polarizer or electrical contacted parts. And after fading condensation, smear or spot will occur.
- (5) When fixed patterns are displayed for a long time, remnant image is likely to occur.
- (6) Module has high frequency circuits. Sufficient suppression to the electromagnetic interference shall be done by system manufacturers. Grounding and shielding methods may be important to minimize the interface.

9.3 Operating Condition for Public Information Display

The device listed in the product specification is designed and manufactured for PID (Public Information Display) application. To optimize module's lifetime and function, below operating usages are required.

(1) Normal operating condition

1. Operating temperature: 5~40
2. Operating humidity: 10~90%
3. Display pattern: dynamic pattern (Real display).

Note) Long-term static display would cause image sticking.

(2) Operation usage to protect against abnormal display due to long-term static display.

- (1) Suitable operating time: under **20** hours a day.
- (2) Liquid Crystal refresh time is required. Cycling display between 5 minutes' information (static) display and 10 seconds' moving image.
- (3) Periodically change background and character (image) color.
- (4) Avoid combination of background and character with large different luminance.

(3) Periodically adopt one of the following actions after long time display.

- A. Running the screen saver (motion picture or black pattern)
- B. Power off the system for a while

(4) LCD system is required to place in well-ventilated environment. Adapting active cooling system is highly recommended.

(5) Product reliability and functions are only guaranteed when the product is used under right operation usages. If product will be used in extreme conditions, such as high temperature/humidity, display stationary patterns, or long operation time etc..., it is strongly recommended to contact AUO for filed application engineering advice. Otherwise, its reliability and function may not be guaranteed. Extreme conditions are commonly found at airports, transit stations, banks, stock market and controlling systems.

9.4 Electrostatic Discharge Control

Since a module is composed of electronic circuits, it is not strong to electrostatic discharge. Make certain that treatment persons are connected to ground through wristband etc. And don't touch interface pin directly.

9.5 Precautions for Strong Light Exposure

Strong light exposure causes degradation of polarizer and color filter.

9.6 Storage

When storing modules as spares for a long time, the following precautions are necessary.

- (1) Store them in a dark place. Do not expose the module to sunlight or fluorescent light. Keep the temperature between 5 and 35 at normal humidity.

- (2) The polarizer surface should not come in contact with any other object. It is recommended that they be stored in the container in which they were shipped.
- (3) Storage condition is guaranteed under packing conditions.
- (4) The phase transition of Liquid Crystal in the condition of the low or high storage temperature will be recovered when the LCD module returns to the normal condition.

9.7 Handling Precautions for Protection Film

- (1) The protection film is attached to the bezel with a small masking tape. When the protection film is peeled off, static electricity is generated between the film and polarizer. This should be peeled off slowly and carefully by people who are electrically grounded and with well ion-blown equipment or in such a condition, etc.
- (2) When the module with protection film attached is stored for a long time, sometimes there remains a very small amount of glue still on the bezel after the protection film is peeled off.
- (3) You can remove the glue easily. When the glue remains on the bezel or its vestige is recognized, please wipe them off with absorbent cotton waste or other soft material like chamois soaked with normal-hexane.