

Apr.1.2020 Copyright 2020 HIROSE ELECTRIC CO., LTD. All Rights Reserved.  
In case of consideration for using Automotive equipment / device which demand high reliability, kindly contact our sales window correspondents.

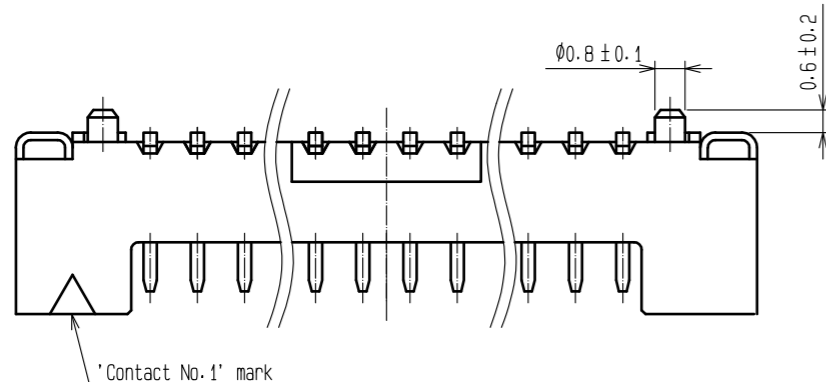

HRS DRAWING FOR REFERENCE

Recommended pattern

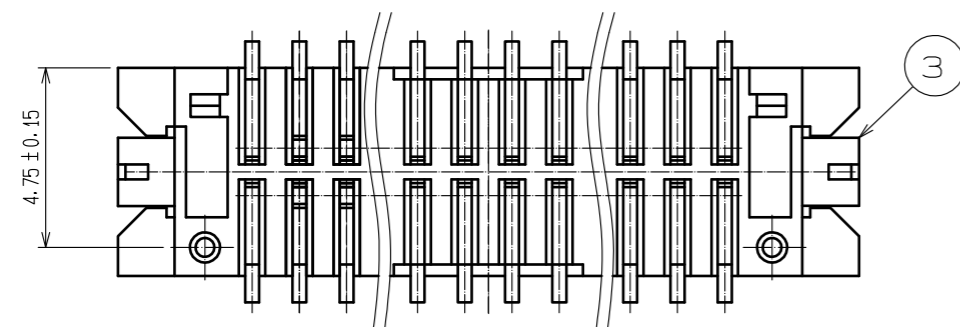
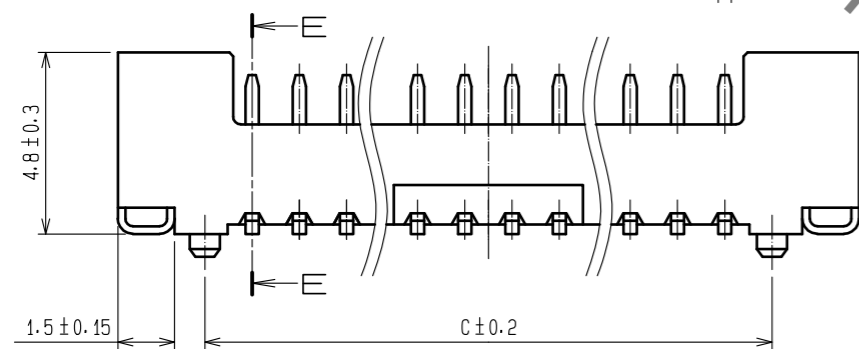
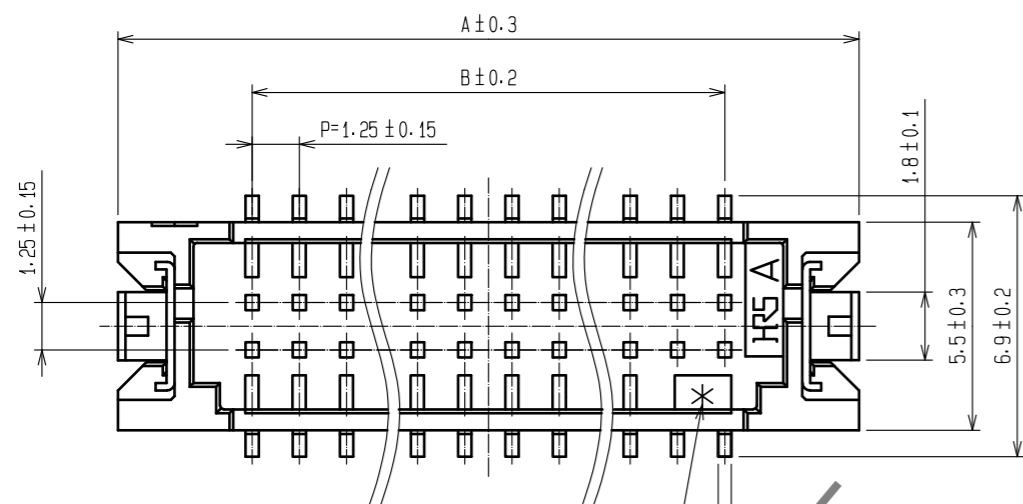
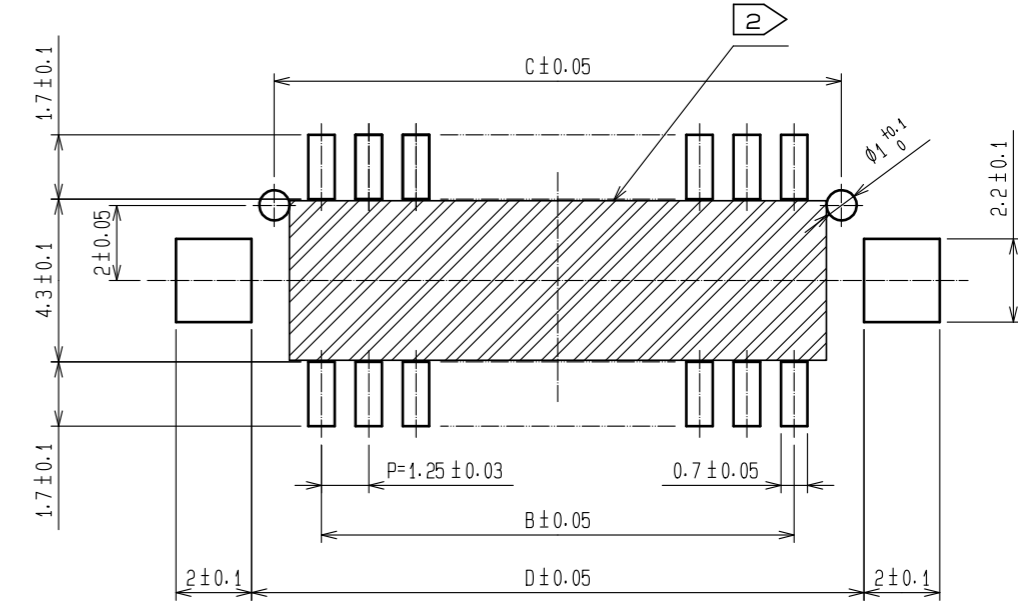

Mated connectors

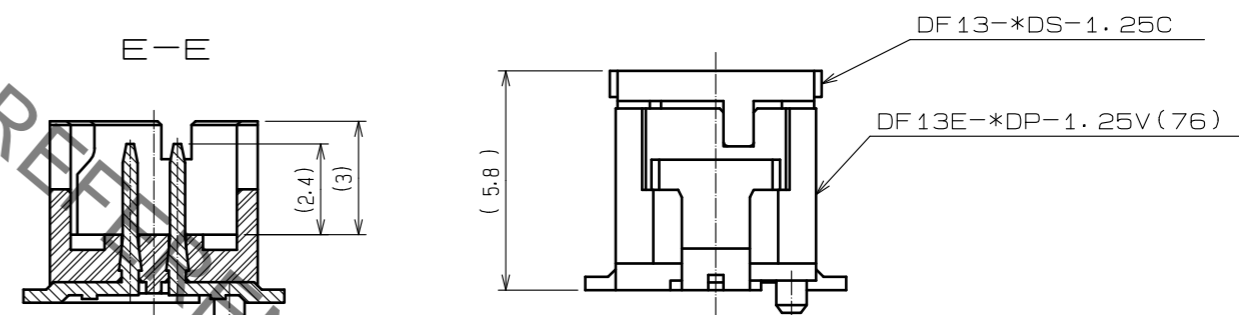

Notes 1 : Lead coplanarity include reinforced metal fittings shall be 0.1mm MAX.  
②: If there are pattern and a bia hole on part, there is a possibility that it will make contact with the leads.

Part No.	Number of contacts	Code No.	A	B	C	D
DF13E-10DP-1.25V(76)	10	CL536-0566-0-76	12.1	5.0	7.5	8.7
DF13E-20DP-1.25V(76)	20	CL536-0567-0-76	18.35	11.25	13.75	14.95
DF13E-30DP-1.25V(76)	30	CL536-0568-0-76	24.60	17.50	20.00	21.20
DF13E-40DP-1.25V(76)	40	CL536-0569-0-76	30.85	23.75	26.25	27.45

NO.	MATERIAL	FINISH .	REMARKS	NO.	MATERIAL	FINISH .	REMARKS
2	Brass	Contact area:Gold plated 0.2µm MIN Lead area:Tin-copper plated 1µm MIN Under plating:Nickel 1µm MIN		5	Elastomer		Gray
1	Polyamide	Beige,UL94V-0		4	R. PVC		Electrostatic protection, Clear
				3	Phosphor bronze		Tin plated 1µm MIN

  

UNITS	SCALE	COUNT	DESCRIPTION OF REVISIONS	DESIGNED	CHECKED	DATE
mm	5 : 1	△				

APPROVED : HS. OKAWA	18.04.05	DRAWING NO.	EDC-367983-76-00
CHECKED : TS. FUKUSHIMA	18.04.05	PART NO.	DF13E-*DP-1.25V(76)
DESIGNED : TS. KUMAZAWA	18.04.05	CODE NO.	CL536-
DRAWN : MK. INOUE	18.04.05		

Apr.1.2020 Copyright 2020 HIROSE ELECTRIC CO., LTD. All Rights Reserved.  
 In case of consideration for using Automotive equipment / device which demand high reliability, kindly contact our sales window correspondents.

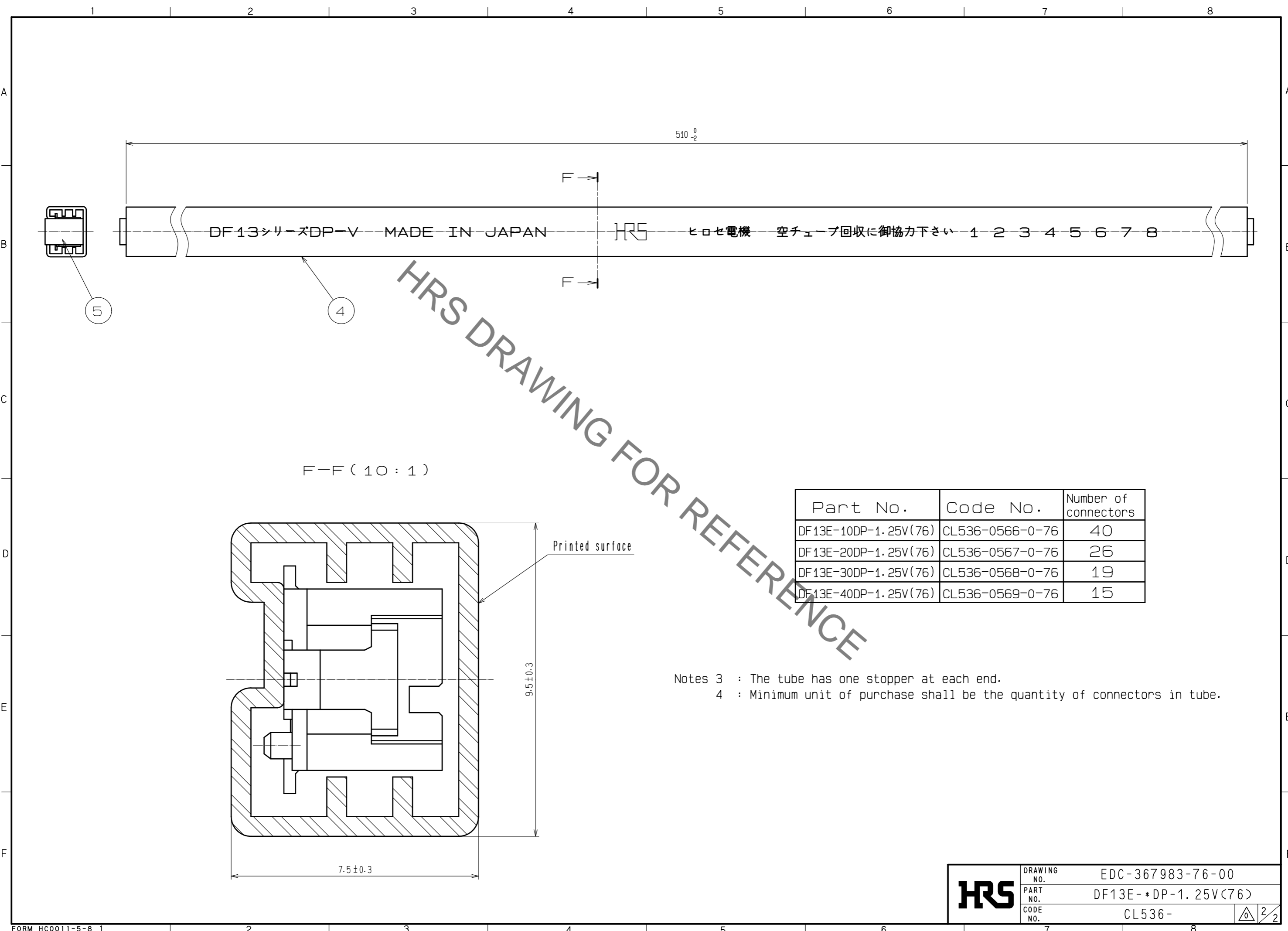

Part No.	Code No.	Number of connectors
DF13E-10DP-1.25V(76)	CL536-0566-0-76	40
DF13E-20DP-1.25V(76)	CL536-0567-0-76	26
DF13E-30DP-1.25V(76)	CL536-0568-0-76	19
DF13E-40DP-1.25V(76)	CL536-0569-0-76	15

Notes 3 : The tube has one stopper at each end.  
 4 : Minimum unit of purchase shall be the quantity of connectors in tube.

<b>HRS</b>	DRAWING NO.	EDC-367983-76-00
	PART NO.	DF13E-*DP-1.25V(76)
	CODE NO.	CL536-

2/2