

High Accuracy GNSS Active Antenna JCA241-300-01S-C

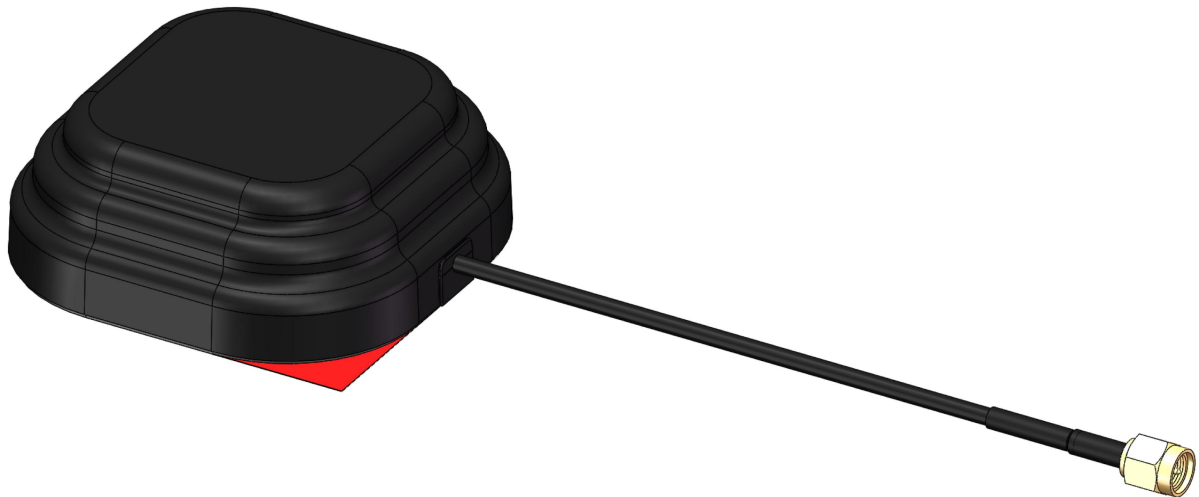

DIMENSIONS

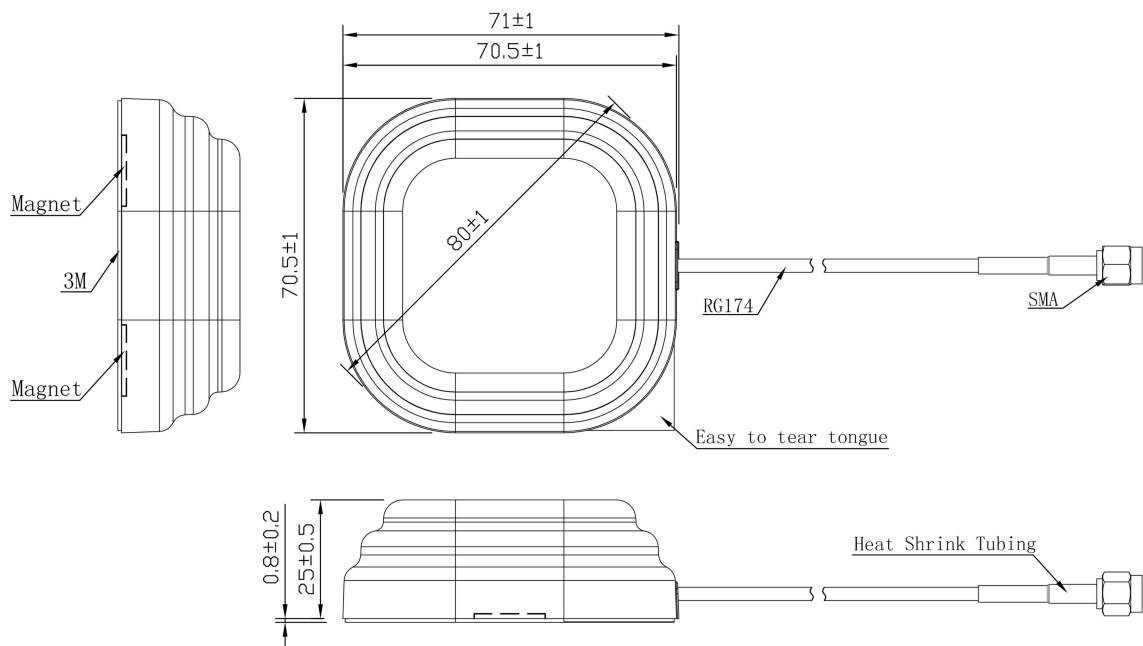

Unit: mm

ZHEJIANG JC ANTENNA CO.,LTD

Add: 398#, Zhenye Road, South Street, Jiaxing, Zhejiang, China

Http:// www.jinchanggps.com

E-mail:sale5@jinchanggps.com

Tel: 86-0573-83692157/83692605/83958637 Fax:86-0573-83958635

SPECIFICATIONS

Item	Specifications	
Antenna (4+4Pins)	Frequency	GPS L1/L2/L5 GLONASS G1/G2/G3 COMPASS B1/B2/B3 Galileo E1/L1/E2/E5a/E5b
	Polarization	RHCP
	Axial Ratio(min)	$\leq 3\text{dB}$
	V.S.W.R	≤ 2.0
	Peak Gain	$\geq 3\text{dBic}$
	Impedance	$50\ \Omega$
	Horizontal coverage angle	360°
LNA	Gain	$28 \pm 2\text{dB}$
	Noise Figure	$\leq 1.5\text{dB}$
	Supply Voltage	3~12V DC
	Current Consumption	$\leq 50\text{mA}$
	V.S.W.R	≤ 2.0
Mechanical	Connector	SMA male
	Cable	RG174 3M
	Mounting Method	Magnet
Environmental	Operating Temperature	$-40^\circ\text{C} \sim +85^\circ\text{C}$
	Relative Humidity	Up to 95%
	Ingress Protection	IP66
	Vibration	10 to 55Hz with 1.5mm amplitude 2hours
	Environmentally Friendly	ROHS Compliant

Radiation Pattern

XY-PLANE

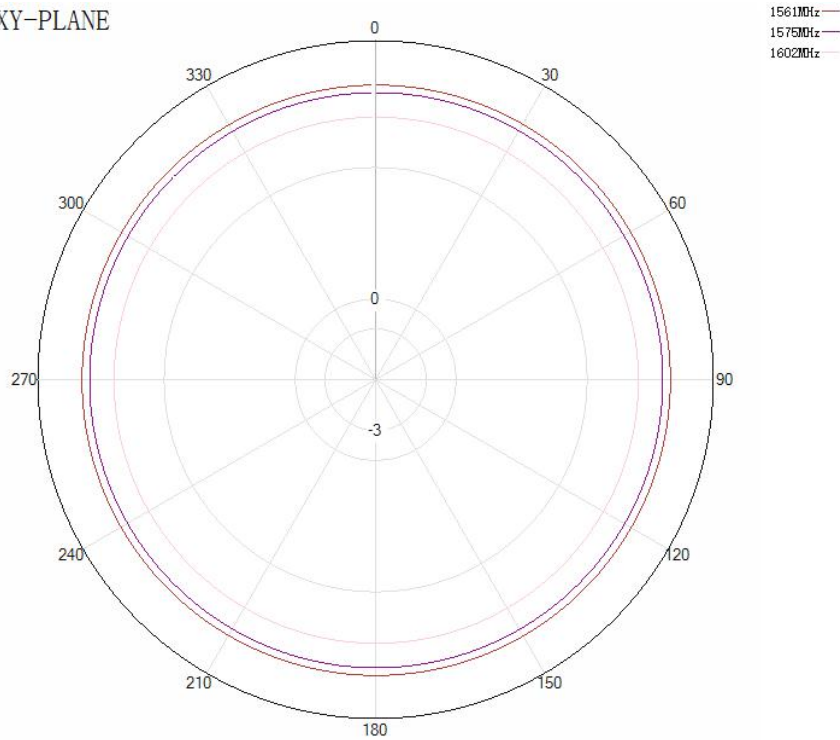

XY-PLANE

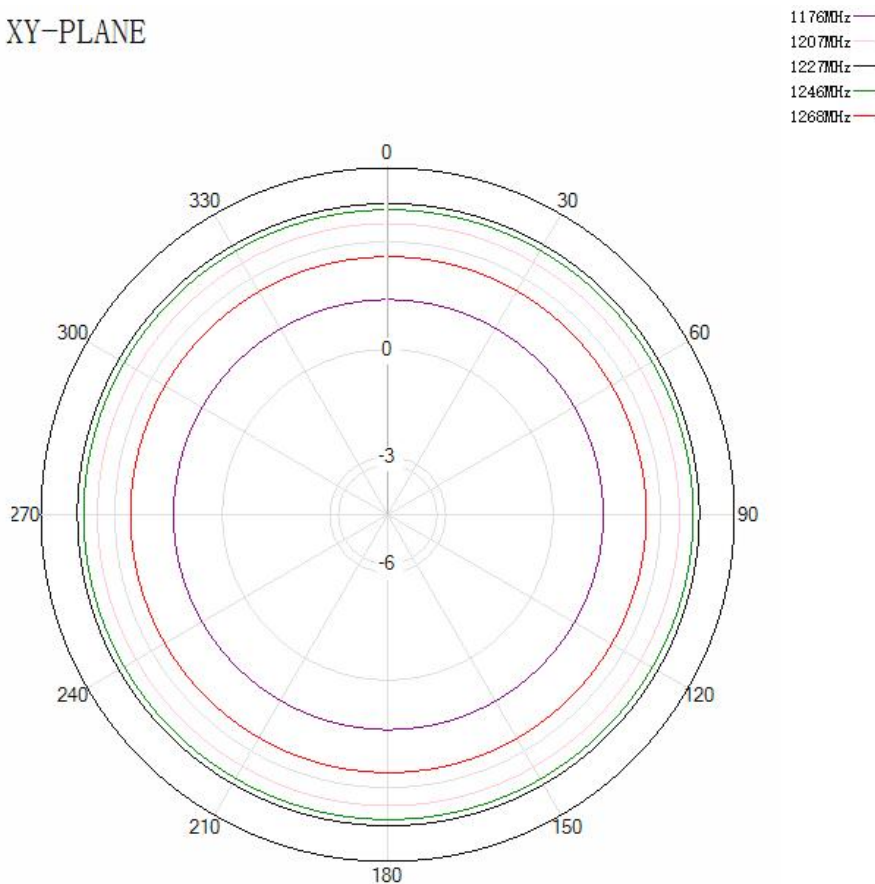

ZHEJIANG JC ANTENNA CO.,LTD

Add: 398#,Zhenye Road, South Street, Jiaxing, Zhejiang, China

Http:// www.jinchanggps.com

E-mail:sale5@jinchanggps.com

Tel: 86-0573-83692157/83692605/83958637 Fax:86-0573-83958635

XZ-PLANE

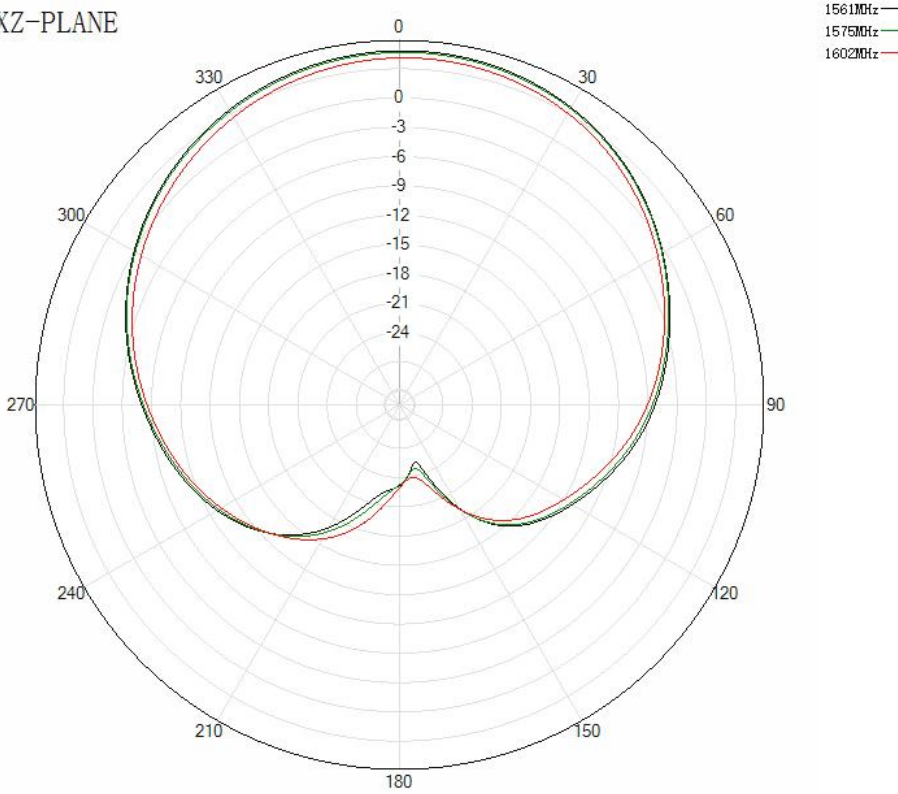

XZ-PLANE

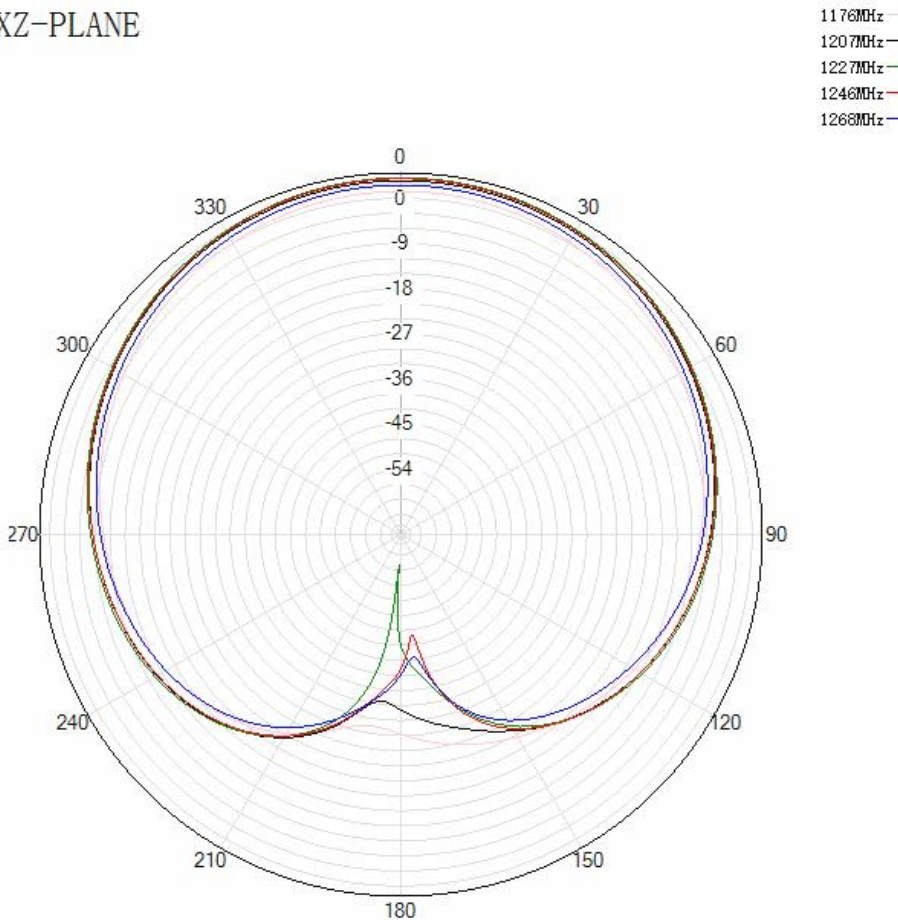

YZ-PLANE

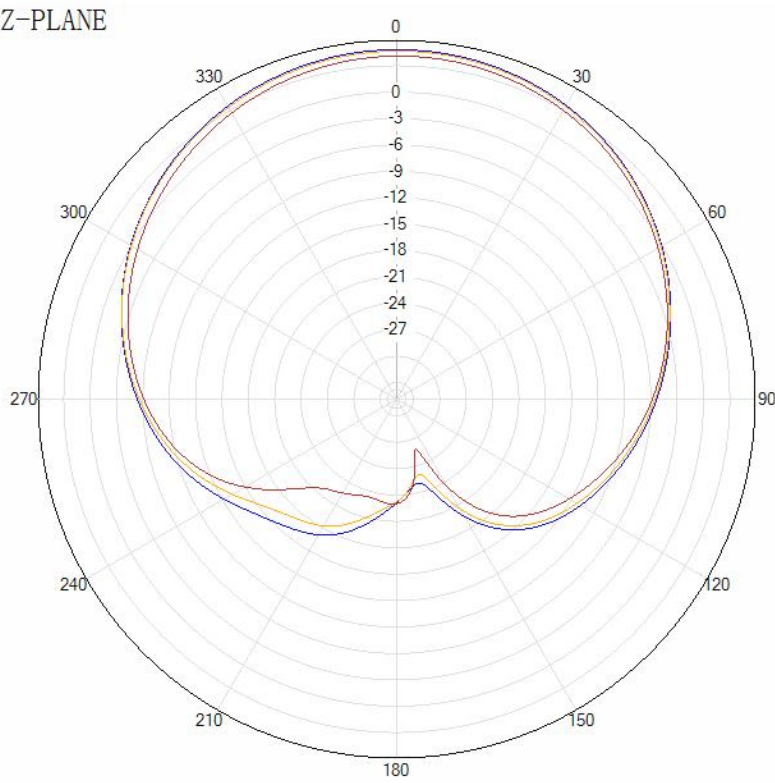

1561MHz
1575MHz
1602MHz

YZ-PLANE

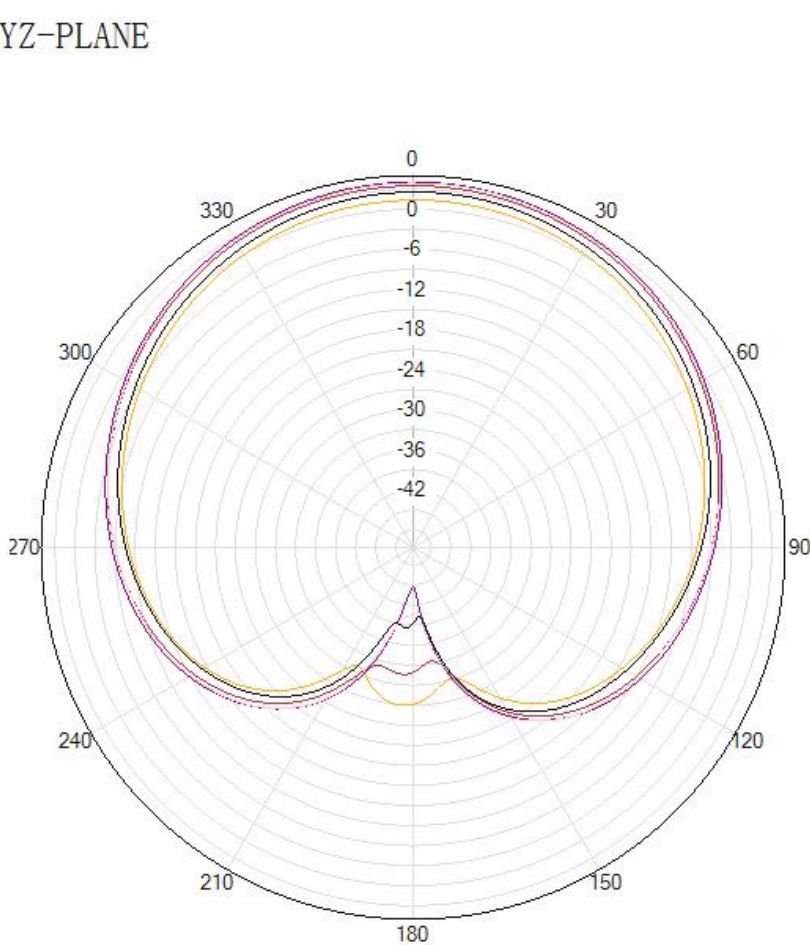

1176MHz
1207MHz
1227MHz
1246MHz
1268MHz

ZHEJIANG JC ANTENNA CO.,LTD

Add: 398#,Zhenye Road, South Street, Jiaxing, Zhejiang, China

Http:// www.jinchanggps.com

E-mail:sale5@jinchanggps.com

Tel: 86-0573-83692157/83692605/83958637 Fax:86-0573-83958635