

ROHS COMPLIANT

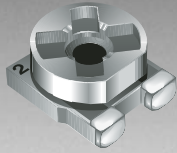

BOURNS®

Features

- Recommended for reflow processing
- Rotor design compatible with pick and place and automatic adjustment equipment
- Supplied in 8 mm embossed tape, compatible with automatic assembly equipment
- Rear adjust version available
- 3 mm size meets EIA/EIAJ standard trimmer footprint
- RoHS compliant* - see [processing information](#) on lead free surface mount trimmers

3303 - 3 mm SMD Trimming Potentiometer

Electrical Characteristics

Standard Resistance Range100 ohms to 1 megohm
 (see standard resistance table)
 Resistance Tolerance±25 % std.
 Absolute Minimum Resistance
 ≤ 1K Ohms20 ohms max.
 >1K Ohms2 % max. of TR
 Contact Resistance Variation ..5 % max.
 ResolutionInfinite
 Adjustment Angle260 ° ±20 °

Environmental Characteristics

Resistance to Soldering Heat
260 °C, 10 seconds, TRS max. 5 %
 Power Rating (50 VDC max.)
 70 °C0.15 watt
 Temperature Range
-40 °C to +125 °C
 Temperature Coefficient
±250 ppm/°C
 Humidity95 %RH
 500 hours
 TRS max.±5 %
 Load Life
@ 70 °C rated power 500 hours
 TRS ± 5 %
 Rotational Cycling20 turns
 TRS ±15 %

Physical Characteristics

Torque20-200 g-cm max.
 Mechanical AngleContinuous
 MarkingPart marking code
 Standard Packaging
2000 pcs./7 " reel
 Adjustment ToolH-90

How To Order

3303 X - 3 - 103 E

Model _____
 Style _____
 Orientation of Parts In Tape:
 • Styles W, C - Terminals Toward Sprocket Holes
 • Styles X, D - Terminals Away From Sprocket Holes (preferred)
 Standard or Modified Product Indicator
 -1 = Single Slot
 -3 = *Cross Slot Low Profile (Standard)
 Resistance Code _____
 Embossed Tape Designator _____

Consult factory for other available options.

*Not available in C and D styles.

3303W, X-3
3mm Open Frame
for Reflow Soldering
3-Terminal
Low Profile

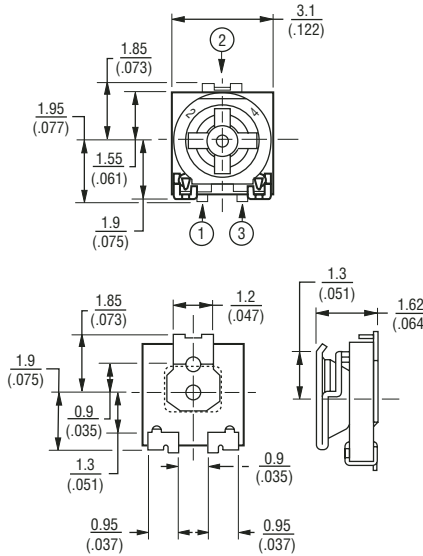

SUGGESTED PWB LAYOUT

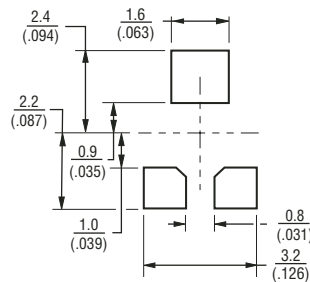

TOLERANCES: ± 0.30 (.012) EXCEPT WHERE NOTED

DIMENSIONS ARE: $\frac{\text{MM}}{\text{(INCHES)}}$

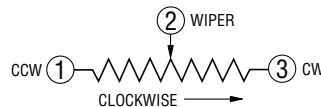

3303C,D-1
3-Terminal
Both Sides Adjust
(OPTIONAL)

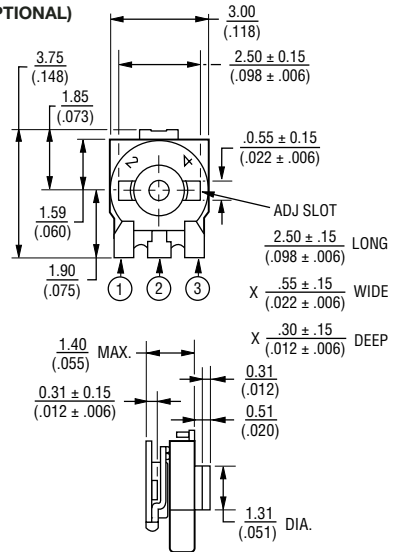

SUGGESTED PWB LAYOUT

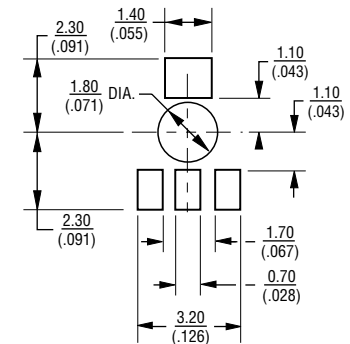

TOLERANCES: ± 0.38 (.015) EXCEPT WHERE NOTED

DIMENSIONS ARE: $\frac{\text{MM}}{\text{(INCHES)}}$

*RoHS Directive 2002/95/EC Jan 27 2003 including Annex. Specifications are subject to change without notice. Customers should verify actual device performance in their specific applications.

3303 - 3 mm SMD Trimming Potentiometer



Packaging Specifications

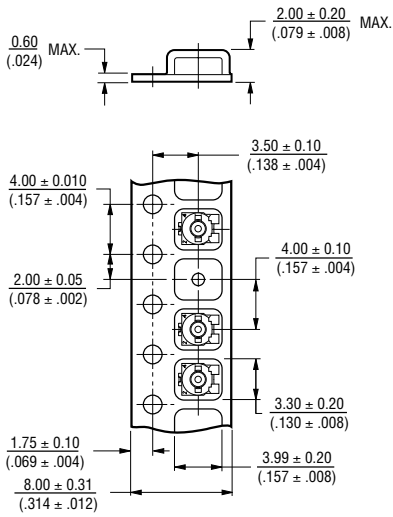

TAPE

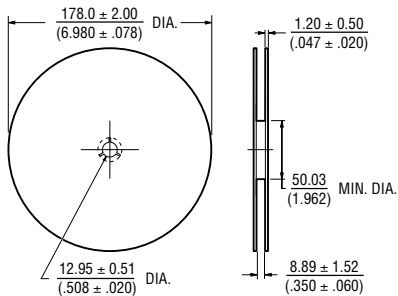

REEL

Meets EIA 481

TOLERANCES: ± 0.25 (.010) EXCEPT WHERE NOTED

DIMENSIONS ARE: $\frac{\text{MM}}{\text{(INCHES)}}$

Standard Resistance Table

Resistance (Ohms)	Part Marking Code	Resistance Code
100	12	101
200	22	201
500	52	501
1,000	13	102
2,000	23	202
5,000	53	502
10,000	14	103
20,000	24	203
50,000	54	503
100,000	15	104
200,000	25	204
500,000	55	504
1,000,000	16	105

Popular distribution resistance values listed in boldface. Special resistances available.