



COB 产品规格书 SPECIFICATION

客户名称 Customer		产品型号 Product No.	B3 Series COB
客户型号 Customer No.		ERP 编码 ERP No.	

客 户 确 认 APPROVED SIGNATURES			

研 究 开 发 中 心 Research & Development Center	
审 批 CHECK 霍文旭	制 定 DRAW 万义标
研 发 部 版本号(Version NO.): B	
文件发放日期(Release Date): 2022-09-09	

※ 确认后请扫描，邮件发送至 huangjuanjuan@szmtc.com.cn。



B3 Series COB Datasheet

B3 系列 COB 规格书

Table of Contents 目录

1. Applications 产品应用	-----	3
2. Features 产品特点	-----	3
3. Part No. Description 产品型号说明	-----	3
4. Package Outline Dimensions 外形尺寸	-----	4
5. Absolute Maximum Ratings 极限参数	-----	5
6. Electro-Optical Characteristics 光电特性	-----	6
7. Bin Code of CIE1931 CIE分级代码	-----	13
8. Typical Characteristics Graphs 典型特性曲线	-----	14
9. Reliability 可靠性	-----	23
10. Packing Specifications 包装规格	-----	24
11. Handling Precautions 使用注意	-----	28



1. Applications 产品应用

- Indoor lighting: LED bulb, Spotlight, Ceiling lamp, Downlight
室内照明: 球泡, 射灯, 天花灯, 筒灯
- Industry and Outdoor lighting: Floodlight, Hight bay light, Streetlight
工业和户外照明: 投光灯, 工矿灯 A, 路灯
- Other illumination 其它照明

2. Features 产品特点

- Support 3w to 200w solution 提供 3w 到 200w 的解决方案
- High efficiency 高光效
- Low thermal resistance 低热阻
- Long time reliability 长时间的可靠性
- RoHS compliant 符合 ROHS 标准

3. Part No. Description 产品型号说明

Example 示例: MA1901-2612081330M-AJC0

Model 型号	MA1901	26	1208	13	30	M	AJC0
Meaning 含义	Series 产品系列	Power 功率	Chip array 芯片排布	Bin code 颜色标准	CCT 色温	CRI 显指	Internal code 内部代码
		26w	12 S 8 P	ANSI. 3step	3000K	>80	

4. Package Outline Dimensions 封装外形尺寸

1) MA1301

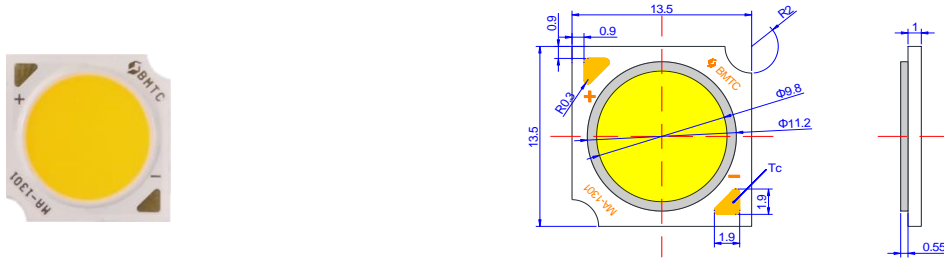

2) MA1901

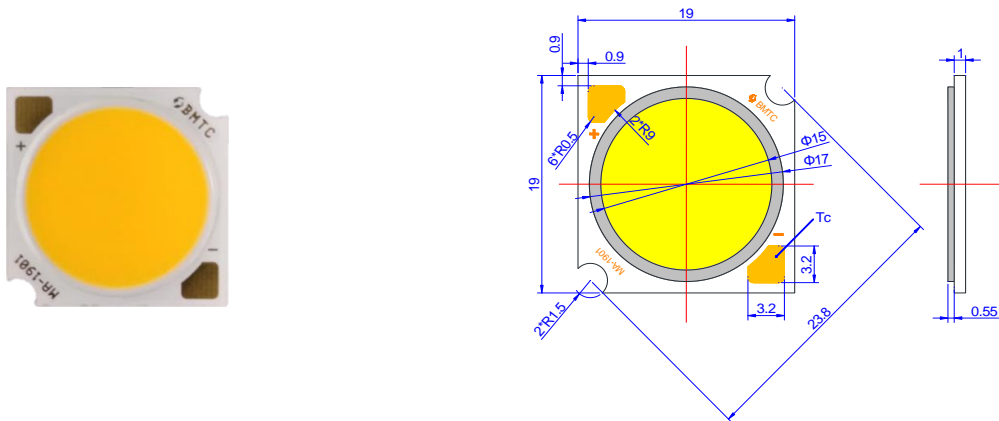

3) MA2801

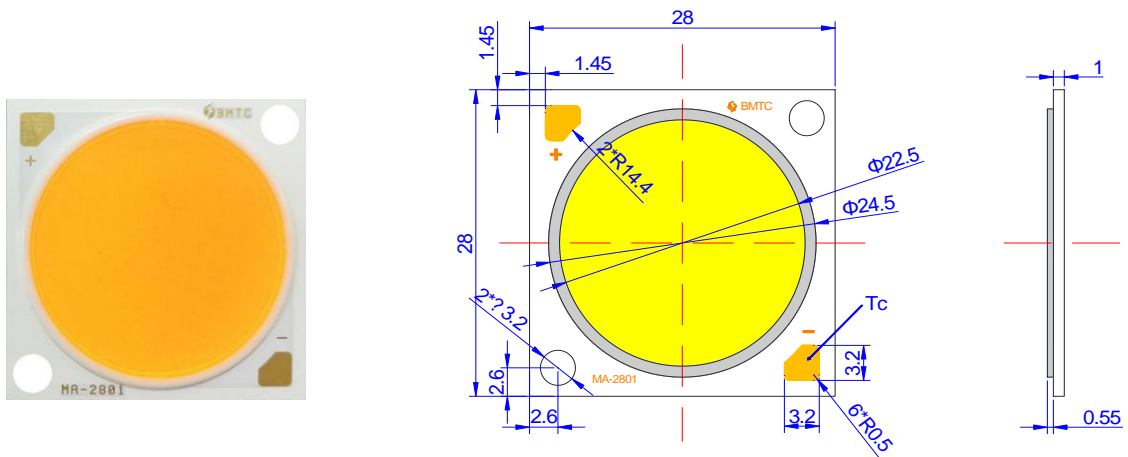

Note:

a. UNIT: MM [INCH]. 单位: 毫米[英寸]

b. The tolerances unless mentioned is ± 0.3 mm. 除非另有说明, 以上尺寸的公差为 ± 0.3 mm。



5. Absolute Maximum Ratings 极限参数

Item	Symbol	Model	Rating	Unit	
Max. Current / Max. Power 最大正向电流 / 最大功率	I _{max} / P _{max}	MA1301	12S1P	230 / 9	mA/W
			12S2P	460 / 18	
			12S3P	690 / 27	
			12S4P	920 / 36	
		MA1901	12S5P	1150 / 44	
			12S6P	1380 / 52	
			12S8P	1840 / 70	
			12S10P	2300 / 88	
		MA2801	12S12P	2760 / 105	
			18S12P	2760 / 157	
			18S18P	4140 / 236	
		Operating Temperature 工作温度	T _a	-	
Storage Temperature 储存温度	T _{stg}	-	-40 ~ +120	°C	
LED Junction Temperature LED 结点温度	T _j	-	150	°C	
Thermal measurement point 热测试点	T _c	-	105	°C	

Note:

- 1) Input power and forward current are the values when the LED is used within the range of the derating curve in this data sheet.本数据表中的输入电源和正向电流值是使用的 LED 降额曲线范围内的值.
- 2) The temperature of Aluminum PCB do not exceed 105°C. 基板负极引线温度不能超过 105°C.
- 3) When hand soldering, keep the temperature of iron below less 350°C less than 5seconds.当手工焊接时,烙铁的温度必须小于 350°C,时间不能超过 5 秒.



6. Electro-Optical Characteristics 光电特性 (Tj=85°C)

1) 3W_MA1301-12S1P

型号 Model	CRI (Min)	Bin Code 色区	CCT	If Typ. (mA)	Vf Min. (V)	Vf Max. (V)	Flux Min. (lm)	Flux Typ. (lm)	Eff. Typ. (lm/W)	Rj-c (°C/W)
MA1301-0312011327M-AJC0	80	1327	2700K	90	30.8	36.8	448	472	155	2.5
MA1301-0312011330M-AJC0	80	1330	3000K	90	30.8	36.8	471	496	163	2.5
MA1301-0312011335M-AJC0	80	1335	3500K	90	30.8	36.8	485	511	168	2.5
MA1301-0312011340M-AJC0	80	1340	4000K	90	30.8	36.8	495	521	171	2.5
MA1301-0312011350M-AJC0	80	1350	5000K	90	30.8	36.8	500	526	173	2.5
MA1301-0312011357M-AJC0	80	1357	5700K	90	30.8	36.8	500	526	173	2.5
MA1301-0312011365M-AJC0	80	1365	6500K	90	30.8	36.8	495	521	171	2.5
MA1301-0312011327H-AJC0	90	1327	2700K	90	30.8	36.8	384	404	133	2.5
MA1301-0312011330H-AJC0	90	1330	3000K	90	30.8	36.8	404	425	140	2.5
MA1301-0312011335H-AJC0	90	1335	3500K	90	30.8	36.8	416	438	144	2.5
MA1301-0312011340H-AJC0	90	1340	4000K	90	30.8	36.8	425	447	147	2.5
MA1301-0312011350H-AJC0	90	1350	5000K	90	30.8	36.8	428	451	148	2.5

2) 6W_MA1301-12S2P

型号 Model	CRI (Min)	Bin Code 色区	CCT	If Typ. (mA)	Vf Min. (V)	Vf Max. (V)	Flux Min. (lm)	Flux Typ. (lm)	Eff. Typ. (lm/W)	Rj-c (°C/W)
MA1301-0612021327M-AJC0	80	1327	2700K	180	30.8	36.8	893	940	155	1.5
MA1301-0612021330M-AJC0	80	1330	3000K	180	30.8	36.8	939	988	162	1.5
MA1301-0612021335M-AJC0	80	1335	3500K	180	30.8	36.8	966	1017	167	1.5
MA1301-0612021340M-AJC0	80	1340	4000K	180	30.8	36.8	985	1037	171	1.5
MA1301-0612021350M-AJC0	80	1350	5000K	180	30.8	36.8	994	1046	172	1.5
MA1301-0612021357M-AJC0	80	1357	5700K	180	30.8	36.8	994	1046	172	1.5
MA1301-0612021365M-AJC0	80	1365	6500K	180	30.8	36.8	985	1037	171	1.5
MA1301-0612021327H-AJC0	90	1327	2700K	180	30.8	36.8	765	805	132	1.5
MA1301-0612021330H-AJC0	90	1330	3000K	180	30.8	36.8	804	846	139	1.5
MA1301-0612021335H-AJC0	90	1335	3500K	180	30.8	36.8	828	872	143	1.5



Technical Data Sheet

P/N: BMTC B-Series Gen.3 COB

Version: B

MA1301-0612021340H-AJC0	90	1340	4000K	180	30.8	36.8	846	890	146	1.5
MA1301-0612021350H-AJC0	90	1350	5000K	180	30.8	36.8	852	897	147	1.5

3) 9W_MA1301-12S3P

型号 Model	CRI (Min)	Bin Code 色区	CCT	If Typ. (mA)	Vf Min. (V)	Vf Max. (V)	Flux Min. (lm)	Flux Typ. (lm)	Eff. Typ. (lm/W)	Rj-c (°C/W)
MA1301-0912031330L-AJC0	70	1330	3000K	270	30.8	36.8	1492	1570	172	0.97
MA1301-0912031340L-AJC0	70	1340	4000K	270	30.8	36.8	1566	1649	181	0.97
MA1301-0912031350L-AJC0	70	1350	5000K	270	30.8	36.8	1579	1663	182	0.97
MA1301-0912031327M-AJC0	80	1327	2700K	270	30.8	36.8	1326	1396	153	0.97
MA1301-0912031330M-AJC0	80	1330	3000K	270	30.8	36.8	1394	1467	161	0.97
MA1301-0912031335M-AJC0	80	1335	3500K	270	30.8	36.8	1435	1510	166	0.97
MA1301-0912031340M-AJC0	80	1340	4000K	270	30.8	36.8	1464	1541	169	0.97
MA1301-0912031350M-AJC0	80	1350	5000K	270	30.8	36.8	1476	1554	170	0.97
MA1301-0912031357M-AJC0	80	1357	5700K	270	30.8	36.8	1476	1554	170	0.97
MA1301-0912031365M-AJC0	80	1365	6500K	270	30.8	36.8	1464	1541	169	0.97
MA1301-0912031327H-AJC0	90	1327	2700K	270	30.8	36.8	1135	1195	131	0.97
MA1301-0912031330H-AJC0	90	1330	3000K	270	30.8	36.8	1194	1257	138	0.97
MA1301-0912031335H-AJC0	90	1335	3500K	270	30.8	36.8	1229	1294	142	0.97
MA1301-0912031340H-AJC0	90	1340	4000K	270	30.8	36.8	1255	1321	145	0.97
MA1301-0912031350H-AJC0	90	1350	5000K	270	30.8	36.8	1265	1332	146	0.97

4) 12W_MA1301-12S4P

型号 Model	CRI (Min)	Bin Code 色区	CCT	If Typ. (mA)	Vf Min. (V)	Vf Max. (V)	Flux Min. (lm)	Flux Typ. (lm)	Eff. Typ. (lm/W)	Rj-c (°C/W)
MA1301-1212041330L-AJC0	70	1330	3000K	360	30.8	36.8	1959	2062	169	0.83
MA1301-1212041340L-AJC0	70	1340	4000K	360	30.8	36.8	2058	2166	178	0.83
MA1301-1212041350L-AJC0	70	1350	5000K	360	30.8	36.8	2075	2184	180	0.83
MA1301-1212041327M-AJC0	80	1327	2700K	360	30.8	36.8	1742	1834	151	0.83
MA1301-1212041330M-AJC0	80	1330	3000K	360	30.8	36.8	1831	1927	158	0.83



江西省兆驰光电有限公司
JIANGXI MTC Lighting Co., Ltd

Technical Data Sheet

P/N: BMTC B-Series Gen.3 COB

Version: B

MA1301-1212041335M-AJC0	80	1335	3500K	360	30.8	36.8	1885	1984	163	0.83
MA1301-1212041340M-AJC0	80	1340	4000K	360	30.8	36.8	1923	2024	166	0.83
MA1301-1212041350M-AJC0	80	1350	5000K	360	30.8	36.8	1939	2041	168	0.83
MA1301-1212041357M-AJC0	80	1357	5700K	360	30.8	36.8	1939	2041	168	0.83
MA1301-1212041365M-AJC0	80	1365	6500K	360	30.8	36.8	1923	2024	166	0.83
MA1301-1212041327H-AJC0	90	1327	2700K	360	30.8	36.8	1492	1570	129	0.83
MA1301-1212041330H-AJC0	90	1330	3000K	360	30.8	36.8	1568	1651	136	0.83
MA1301-1212041335H-AJC0	90	1335	3500K	360	30.8	36.8	1615	1700	140	0.83
MA1301-1212041340H-AJC0	90	1340	4000K	360	30.8	36.8	1648	1735	143	0.83
MA1301-1212041350H-AJC0	90	1350	5000K	360	30.8	36.8	1663	1750	144	0.83

5) 16W_MA1901-12S5P

型号 Model	CRI (Min)	Bin Code 色区	CCT	If Typ. (mA)	Vf Min. (V)	Vf Max. (V)	Flux Min. (lm)	Flux Typ. (lm)	Eff. Typ. (lm/W)	Rj-c (°C/W)
MA1901-1612051330L-AJC0	70	1330	3000K	450	30.8	36.8	2523	2656	174	0.66
MA1901-1612051340L-AJC0	70	1340	4000K	450	30.8	36.8	2649	2788	183	0.66
MA1901-1612051350L-AJC0	70	1350	5000K	450	30.8	36.8	2672	2812	185	0.66
MA1901-1612051327M-AJC0	80	1327	2700K	450	30.8	36.8	2244	2362	155	0.66
MA1901-1612051330M-AJC0	80	1330	3000K	450	30.8	36.8	2358	2482	163	0.66
MA1901-1612051335M-AJC0	80	1335	3500K	450	30.8	36.8	2427	2555	168	0.66
MA1901-1612051340M-AJC0	80	1340	4000K	450	30.8	36.8	2476	2606	171	0.66
MA1901-1612051350M-AJC0	80	1350	5000K	450	30.8	36.8	2497	2628	173	0.66
MA1901-1612051357M-AJC0	80	1357	5700K	450	30.8	36.8	2497	2628	173	0.66
MA1901-1612051365M-AJC0	80	1365	6500K	450	30.8	36.8	2476	2606	171	0.66
MA1901-1612051327H-AJC0	90	1327	2700K	450	30.8	36.8	1920	2021	133	0.66
MA1901-1612051330H-AJC0	90	1330	3000K	450	30.8	36.8	2020	2126	140	0.66
MA1901-1612051335H-AJC0	90	1335	3500K	450	30.8	36.8	2081	2190	144	0.66
MA1901-1612051340H-AJC0	90	1340	4000K	450	30.8	36.8	2123	2235	147	0.66
MA1901-1612051350H-AJC0	90	1350	5000K	450	30.8	36.8	2141	2254	148	0.66



6) 19W_MA1901-12S6P

型号 Model	CRI (Min)	Bin Code 色区	CCT	If Typ. (mA)	Vf Min. (V)	Vf Max. (V)	Flux Min. (lm)	Flux Typ. (lm)	Eff. Typ. (lm/W)	Rj-c (°C/W)
MA1901-1912061330L-AJC0	70	1330	3000K	540	30.8	36.8	3013	3171	173	0.59
MA1901-1912061340L-AJC0	70	1340	4000K	540	30.8	36.8	3163	3330	183	0.59
MA1901-1912061350L-AJC0	70	1350	5000K	540	30.8	36.8	3190	3358	184	0.59
MA1901-1912061327M-AJC0	80	1327	2700K	540	30.8	36.8	2680	2821	155	0.59
MA1901-1912061330M-AJC0	80	1330	3000K	540	30.8	36.8	2816	2964	162	0.59
MA1901-1912061335M-AJC0	80	1335	3500K	540	30.8	36.8	2898	3051	167	0.59
MA1901-1912061340M-AJC0	80	1340	4000K	540	30.8	36.8	2956	3112	171	0.59
MA1901-1912061350M-AJC0	80	1350	5000K	540	30.8	36.8	2981	3138	172	0.59
MA1901-1912061357M-AJC0	80	1357	5700K	540	30.8	36.8	2981	3138	172	0.59
MA1901-1912061365M-AJC0	80	1365	6500K	540	30.8	36.8	2956	3112	171	0.59
MA1901-1912061327H-AJC0	90	1327	2700K	540	30.8	36.8	2293	2414	132	0.59
MA1901-1912061330H-AJC0	90	1330	3000K	540	30.8	36.8	2412	2539	139	0.59
MA1901-1912061335H-AJC0	90	1335	3500K	540	30.8	36.8	2484	2615	143	0.59
MA1901-1912061340H-AJC0	90	1340	4000K	540	30.8	36.8	2536	2669	146	0.59
MA1901-1912061350H-AJC0	90	1350	5000K	540	30.8	36.8	2556	2691	147	0.59

7) 26W_MA1901-12S8P

型号 Model	CRI (Min)	Bin Code 色区	CCT	If Typ. (mA)	Vf Min. (V)	Vf Max. (V)	Flux Min. (lm)	Flux Typ. (lm)	Eff. Typ. (lm/W)	Rj-c (°C/W)
MA1901-2612081330L-AJC0	70	1330	3000K	720	30.8	36.8	3958	4167	171	0.47
MA1901-2612081340L-AJC0	70	1340	4000K	720	30.8	36.8	4156	4374	180	0.47
MA1901-2612081350L-AJC0	70	1350	5000K	720	30.8	36.8	4190	4411	181	0.47
MA1901-2612081327M-AJC0	80	1327	2700K	720	30.8	36.8	3520	3705	152	0.47
MA1901-2612081330M-AJC0	80	1330	3000K	720	30.8	36.8	3699	3894	160	0.47
MA1901-2612081335M-AJC0	80	1335	3500K	720	30.8	36.8	3808	4008	165	0.47
MA1901-2612081340M-AJC0	80	1340	4000K	720	30.8	36.8	3884	4088	168	0.47
MA1901-2612081350M-AJC0	80	1350	5000K	720	30.8	36.8	3916	4122	169	0.47



Technical Data Sheet

P/N: BMTC B-Series Gen.3 COB

Version: B

MA1901-2612081357M-AJC0	80	1357	5700K	720	30.8	36.8	3916	4122	169	0.47
MA1901-2612081365M-AJC0	80	1365	6500K	720	30.8	36.8	3884	4088	168	0.47
MA1901-2612081327H-AJC0	90	1327	2700K	720	30.8	36.8	3012	3171	130	0.47
MA1901-2612081330H-AJC0	90	1330	3000K	720	30.8	36.8	3168	3335	137	0.47
MA1901-2612081335H-AJC0	90	1335	3500K	720	30.8	36.8	3263	3435	141	0.47
MA1901-2612081340H-AJC0	90	1340	4000K	720	30.8	36.8	3330	3505	144	0.47
MA1901-2612081350H-AJC0	90	1350	5000K	720	30.8	36.8	3359	3536	145	0.47

8) 33W_MA1901-12S10P

型号 Model	CRI (Min)	Bin Code 色区	CCT	If Typ. (mA)	Vf Min. (V)	Vf Max. (V)	Flux Min. (lm)	Flux Typ. (lm)	Eff. Typ. (lm/W)	Rj-c (°C/W)
MA1901-3312101330L-AJC0	70	1330	3000K	900	30.8	36.8	4898	5156	169	0.39
MA1901-3312101340L-AJC0	70	1340	4000K	900	30.8	36.8	5142	5413	178	0.39
MA1901-3312101350L-AJC0	70	1350	5000K	900	30.8	36.8	5185	5458	180	0.39
MA1901-3312101327M-AJC0	80	1327	2700K	900	30.8	36.8	4356	4585	151	0.39
MA1901-3312101330M-AJC0	80	1330	3000K	900	30.8	36.8	4578	4819	158	0.39
MA1901-3312101335M-AJC0	80	1335	3500K	900	30.8	36.8	4712	4960	163	0.39
MA1901-3312101340M-AJC0	80	1340	4000K	900	30.8	36.8	4806	5059	166	0.39
MA1901-3312101350M-AJC0	80	1350	5000K	900	30.8	36.8	4846	5101	168	0.39
MA1901-3312101357M-AJC0	80	1357	5700K	900	30.8	36.8	4846	5101	168	0.39
MA1901-3312101365M-AJC0	80	1365	6500K	900	30.8	36.8	4806	5059	166	0.39
MA1901-3312101327H-AJC0	90	1327	2700K	900	30.8	36.8	3728	3924	129	0.39
MA1901-3312101327H-AJC0	90	1327	3000K	900	30.8	36.8	3922	4128	136	0.39
MA1901-3312101327H-AJC0	90	1327	3500K	900	30.8	36.8	4038	4251	140	0.39
MA1901-3312101327H-AJC0	90	1327	4000K	900	30.8	36.8	4121	4338	143	0.39
MA1901-3312101327H-AJC0	90	1327	5000K	900	30.8	36.8	4156	4375	144	0.39

9) 40W_MA2801-12S12P

型号 Model	CRI (Min)	Bin Code 色区	CCT	If Typ. (mA)	Vf Min. (V)	Vf Max. (V)	Flux Min. (lm)	Flux Typ. (lm)	Eff. Typ. (lm/W)	Rj-c (°C/W)
-------------	--------------	-------------------	-----	-----------------	----------------	----------------	-------------------	-------------------	---------------------	----------------



江西省兆驰光电有限公司
JIANGXI MTC Lighting Co., Ltd

Technical Data Sheet

P/N: BMTC B-Series Gen.3 COB

Version: B

MA2801-4012121330L-AJC0	70	1330	3000K	1080	30.8	36.8	6026	6343	173	0.31
MA2801-4012121340L-AJC0	70	1340	4000K	1080	30.8	36.8	6327	6660	183	0.31
MA2801-4012121350L-AJC0	70	1350	5000K	1080	30.8	36.8	6379	6715	184	0.31
MA2801-4012121327M-AJC0	80	1327	2700K	1080	30.8	36.8	5359	5641	155	0.31
MA2801-4012121330M-AJC0	80	1330	3000K	1080	30.8	36.8	5632	5928	162	0.31
MA2801-4012121335M-AJC0	80	1335	3500K	1080	30.8	36.8	5797	6102	167	0.31
MA2801-4012121340M-AJC0	80	1340	4000K	1080	30.8	36.8	5913	6224	171	0.31
MA2801-4012121350M-AJC0	80	1350	5000K	1080	30.8	36.8	5962	6276	172	0.31
MA2801-4012121357M-AJC0	80	1357	5700K	1080	30.8	36.8	5962	6276	172	0.31
MA2801-4012121365M-AJC0	80	1365	6500K	1080	30.8	36.8	5913	6224	171	0.31
MA2801-4012121327H-AJC0	90	1327	2700K	1080	30.8	36.8	4587	4828	132	0.31
MA2801-4012121330H-AJC0	90	1330	3000K	1080	30.8	36.8	4824	5078	139	0.31
MA2801-4012121335H-AJC0	90	1335	3500K	1080	30.8	36.8	4968	5229	143	0.31
MA2801-4012121340H-AJC0	90	1340	4000K	1080	30.8	36.8	5070	5337	146	0.31
MA2801-4012121350H-AJC0	90	1350	5000K	1080	30.8	36.8	5114	5383	147	0.31

10) 60W_MA2801-18S12P

型号 Model	CRI (Min)	Bin Code 色区	CCT	If Typ. (mA)	Vf Min. (V)	Vf Max. (V)	Flux Min. (lm)	Flux Typ. (lm)	Eff. Typ. (lm/W)	Rj-c (°C/W)
MA2801-6018121330L-AJC0	70	1330	3000K	1080	46.2	55.2	8906	9374	171	0.23
MA2801-6018121340L-AJC0	70	1340	4000K	1080	46.2	55.2	9350	9842	180	0.23
MA2801-6018121350L-AJC0	70	1350	5000K	1080	46.2	55.2	9428	9924	181	0.23
MA2801-6018121327M-AJC0	80	1327	2700K	1080	46.2	55.2	7920	8337	152	0.23
MA2801-6018121330M-AJC0	80	1330	3000K	1080	46.2	55.2	8323	8761	160	0.23
MA2801-6018121335M-AJC0	80	1335	3500K	1080	46.2	55.2	8567	9018	165	0.23
MA2801-6018121340M-AJC0	80	1340	4000K	1080	46.2	55.2	8738	9198	168	0.23
MA2801-6018121350M-AJC0	80	1350	5000K	1080	46.2	55.2	8811	9275	169	0.23
MA2801-6018121357M-AJC0	80	1357	5700K	1080	46.2	55.2	8811	9275	169	0.23
MA2801-6018121365M-AJC0	80	1365	6500K	1080	46.2	55.2	8738	9198	168	0.23
MA2801-6018121327H-AJC0	90	1327	2700K	1080	46.2	55.2	6778	7135	130	0.23
MA2801-6018121330H-AJC0	90	1330	3000K	1080	46.2	55.2	7130	7505	137	0.23



Technical Data Sheet

P/N: BMTC B-Series Gen.3 COB

Version: B

MA2801-6018121335H-AJC0	90	1335	3500K	1080	46.2	55.2	7342	7728	141	0.23
MA2801-6018121340H-AJC0	90	1340	4000K	1080	46.2	55.2	7493	7887	144	0.23
MA2801-6018121350H-AJC0	90	1350	5000K	1080	46.2	55.2	7557	7955	145	0.23

11) 80W_MA2801-18S18P

型号 Model	CRI (Min)	Bin Code 色区	CCT	If Typ. (mA)	Vf Min. (V)	Vf Max. (V)	Flux Min. (lm)	Flux Typ. (lm)	Eff. Typ. (lm/W)	Rj-c (°C/W)
MA2801-8018181330L-AJC0	70	1330	3000K	1620	46.2	55.2	13091	13781	168	0.16
MA2801-8018181340L-AJC0	70	1340	4000K	1620	46.2	55.2	13744	14467	177	0.16
MA2801-8018181350L-AJC0	70	1350	5000K	1620	46.2	55.2	13860	14589	178	0.16
MA2801-8018181327M-AJC0	80	1327	2700K	1620	46.2	55.2	11642	12255	149	0.16
MA2801-8018181330M-AJC0	80	1330	3000K	1620	46.2	55.2	12235	12879	157	0.16
MA2801-8018181335M-AJC0	80	1335	3500K	1620	46.2	55.2	12593	13256	161	0.16
MA2801-8018181340M-AJC0	80	1340	4000K	1620	46.2	55.2	12845	13521	165	0.16
MA2801-8018181350M-AJC0	80	1350	5000K	1620	46.2	55.2	12953	13635	166	0.16
MA2801-8018181357M-AJC0	80	1357	5700K	1620	46.2	55.2	12953	13635	166	0.16
MA2801-8018181365M-AJC0	80	1365	6500K	1620	46.2	55.2	12845	13521	165	0.16
MA2801-8018181327H-AJC0	90	1327	2700K	1620	46.2	55.2	9964	10488	128	0.16
MA2801-8018181330H-AJC0	90	1330	3000K	1620	46.2	55.2	10480	11032	134	0.16
MA2801-8018181335H-AJC0	90	1335	3500K	1620	46.2	55.2	10793	11361	138	0.16
MA2801-8018181340H-AJC0	90	1340	4000K	1620	46.2	55.2	11014	11594	141	0.16
MA2801-8018181350H-AJC0	90	1350	5000K	1620	46.2	55.2	11109	11694	142	0.16

Note:

1) Color bins are defined at rated test current operation. If use different forward current, it may cause the change of chromaticity and forward voltage (Tj=Tc=85°C) .

该产品通过瞬态额定电流测试分光分色，若使用不同电流，可能会引起色温及电压的变化。

2) BMTC maintains measurement tolerance of: Luminous flux = ±10 %, CRI = ±2, VF±3%.

不同标准源测试存在仪器公差：流明±10%，显指±2 和电压±3%。

7. Bin Code of CIE1931 CIE 分级代码 (If = Typ. If, Tj = 25°C)

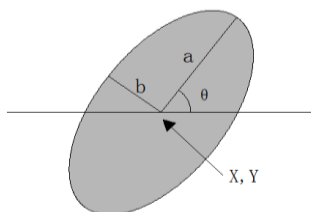
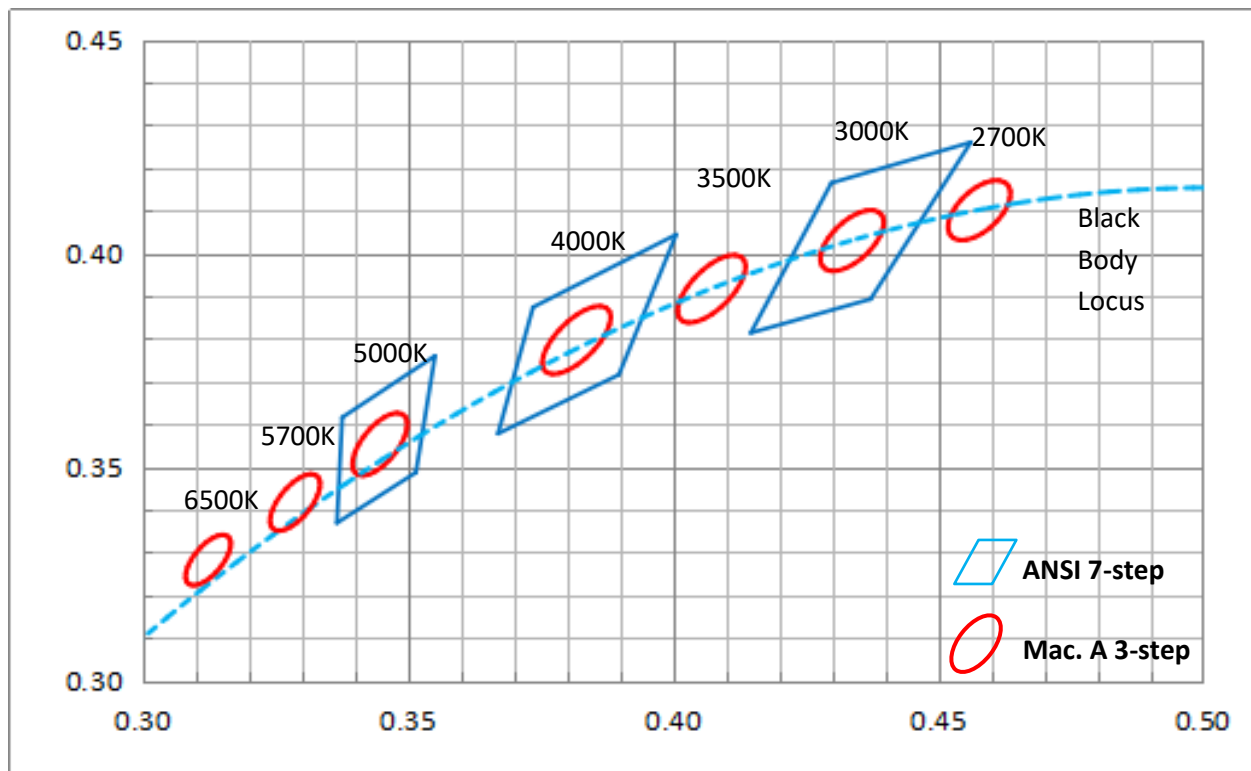

Step	CCT	X	Y	θ	a	b
3-Step	2700K	0.4578	0.4101	53.70	0.0081	0.0042
3-Step	3000K	0.4339	0.4033	53.22	0.0083	0.0041
3-Step	3500K	0.4078	0.393	54.00	0.0093	0.0041
3-Step	4000K	0.3818	0.3797	53.72	0.0094	0.0040
3-Step	5000K	0.3446	0.3551	59.62	0.0082	0.0035
3-Step	5700K	0.3287	0.3425	59.13	0.0075	0.0032
3-Step	6500K	0.3123	0.3283	58.57	0.0067	0.0029

Note: Tolerance of Color coordinates is ± 0.005 .

色坐标 x, y 的测量误差为 ± 0.005 。

8. Typical Characteristics Graphs 典型特性曲线

a) 光谱图 Spectrum Distribution (IF= Sorting Current, Tj = 25°C)

1) Ra70

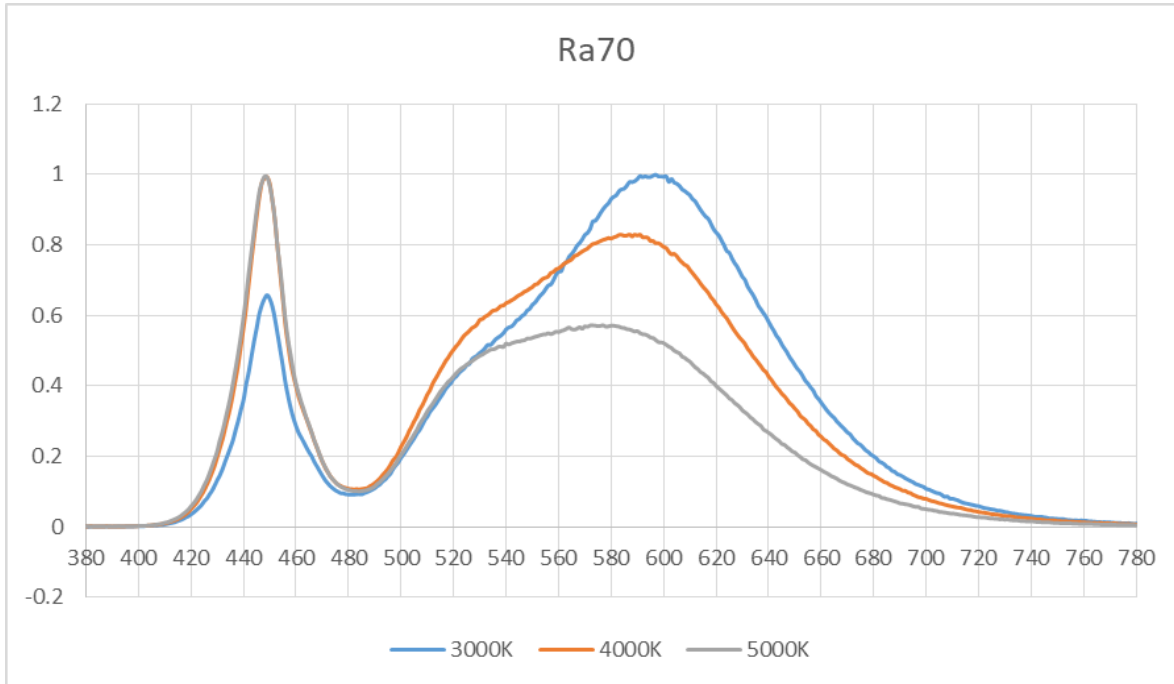

2) Ra80

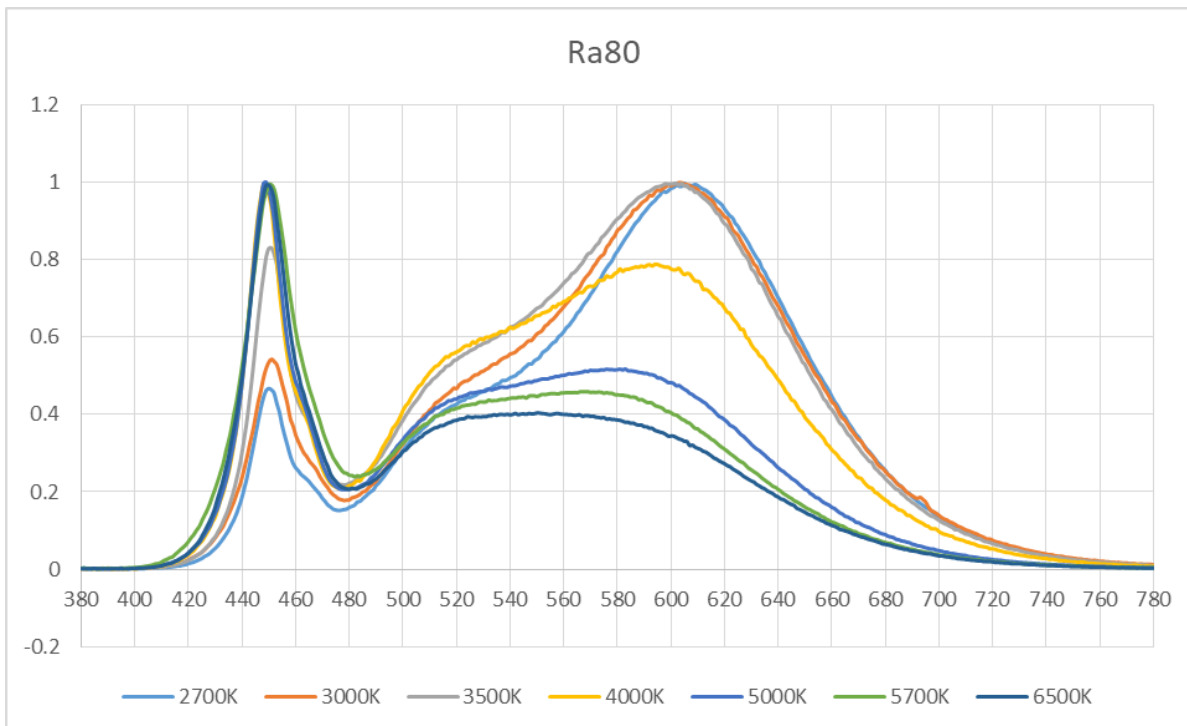

3)Ra90



b) 电流特性曲线 Forward Current Characteristics(Tj=25°C)

1) 3W_MA1301-12S1P

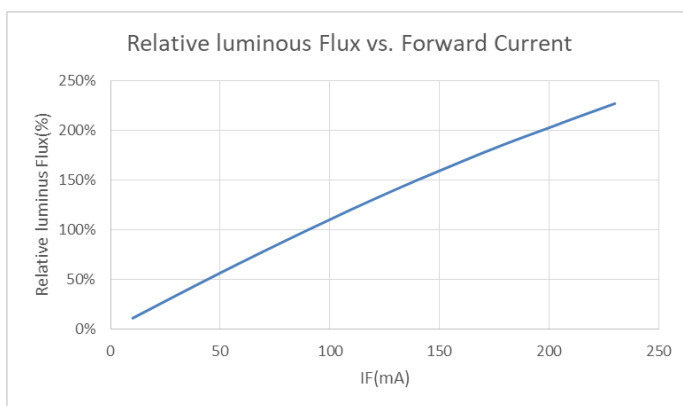
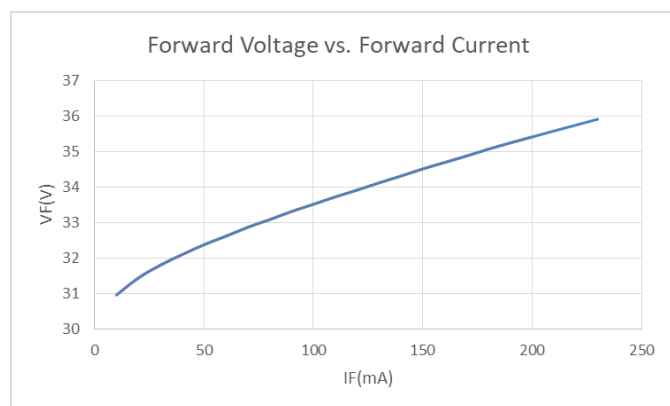

2) 6W_MA1301-12S2P

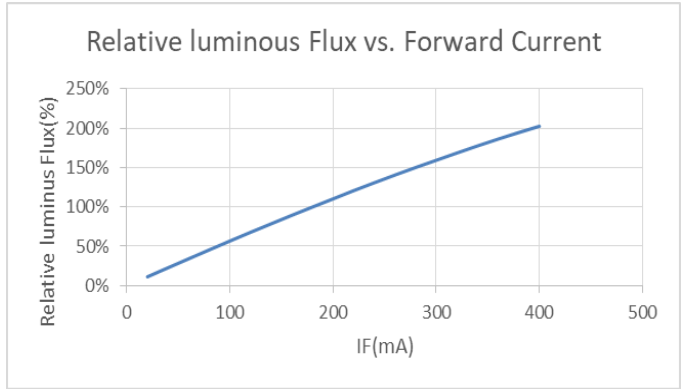
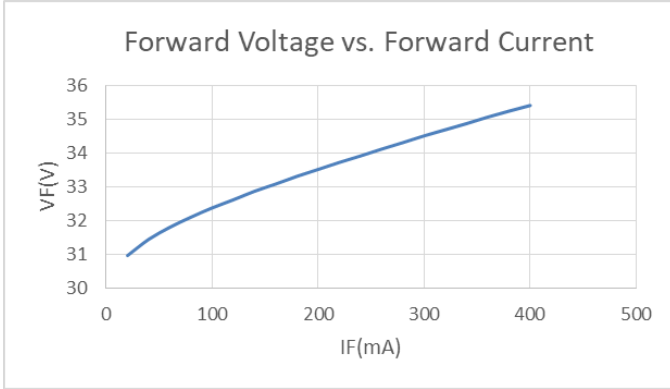

3) 9W_MA1301-12S3P

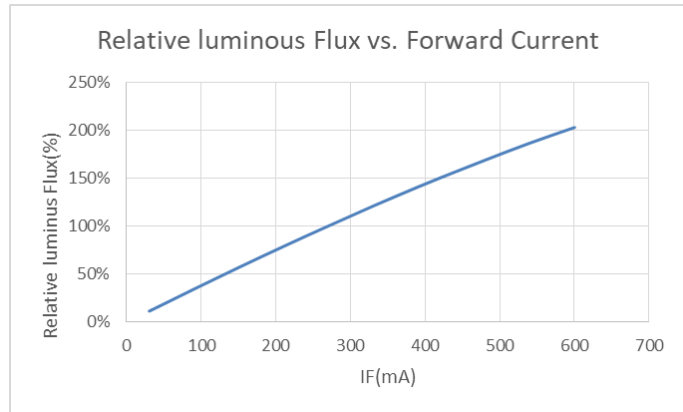
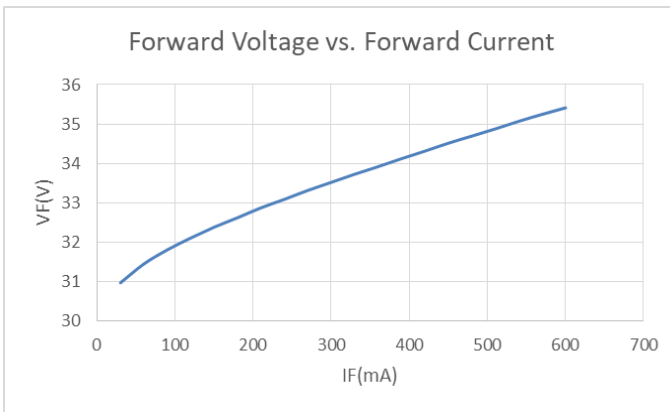

4) 12W_MA1301-12S4P

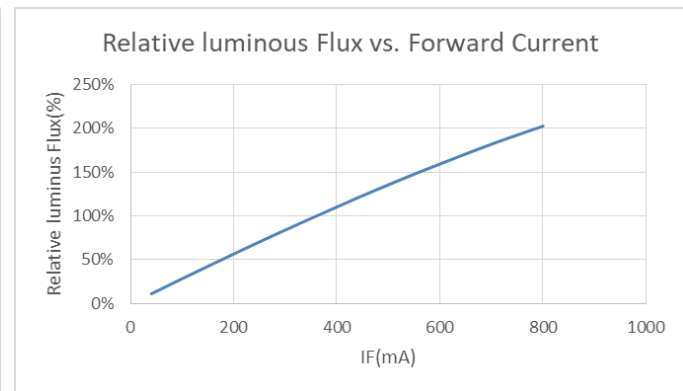
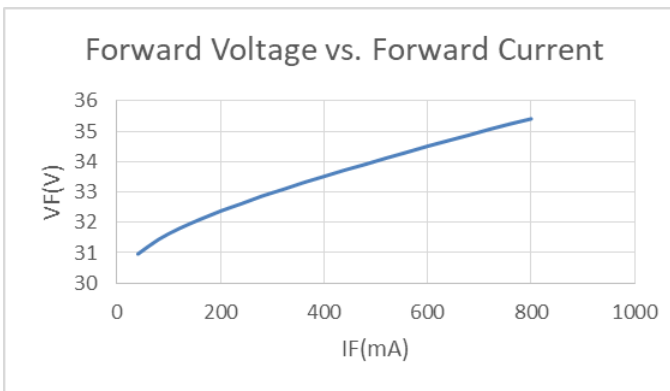

5) 16W_MA1901-12S5P

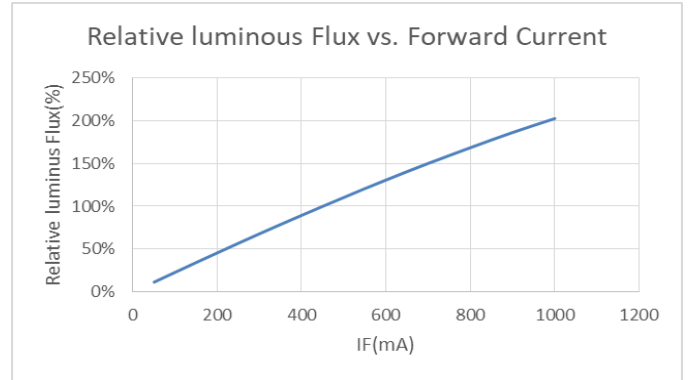
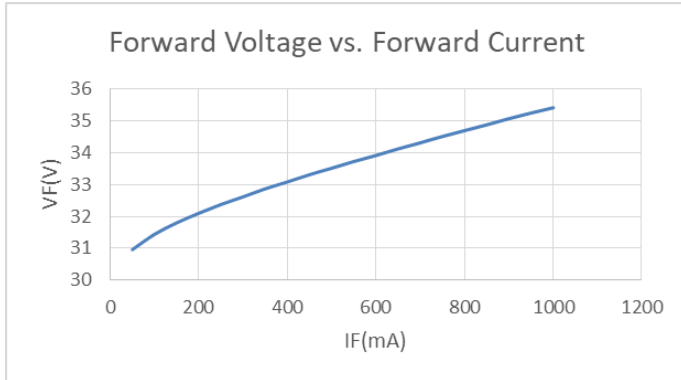

6) 19W_MA1901-12S6P

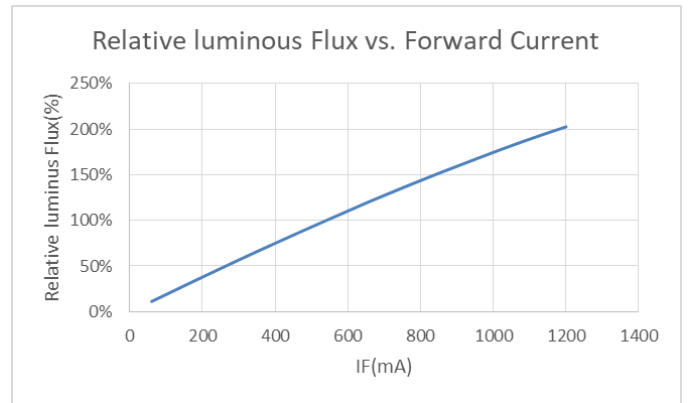
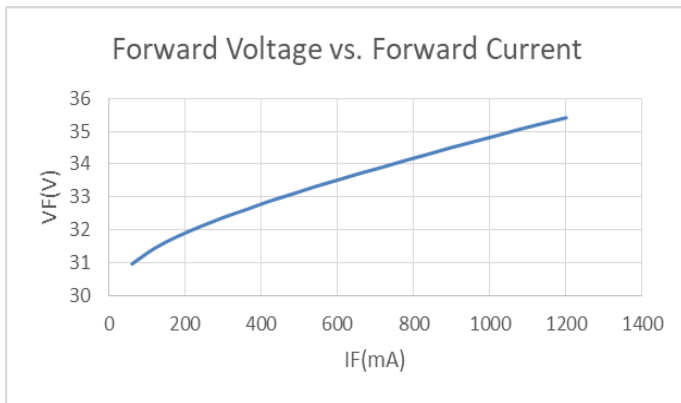

7) 26W_MA1901-12S8P

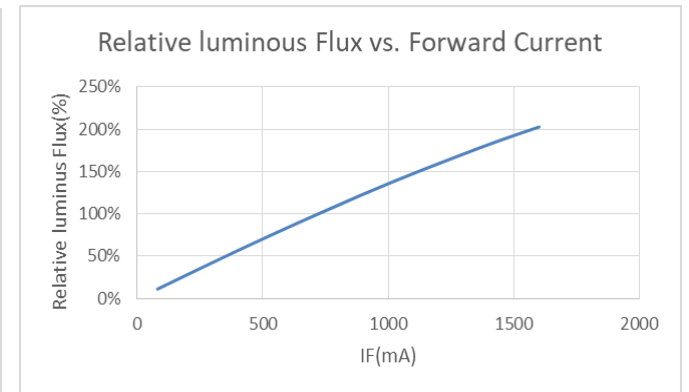
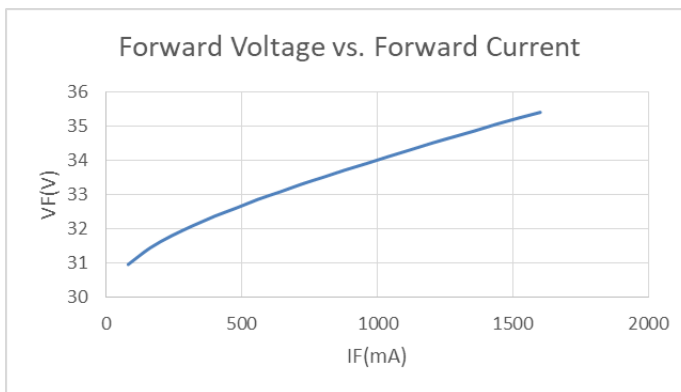

8) 33W_MA1901-12S10P

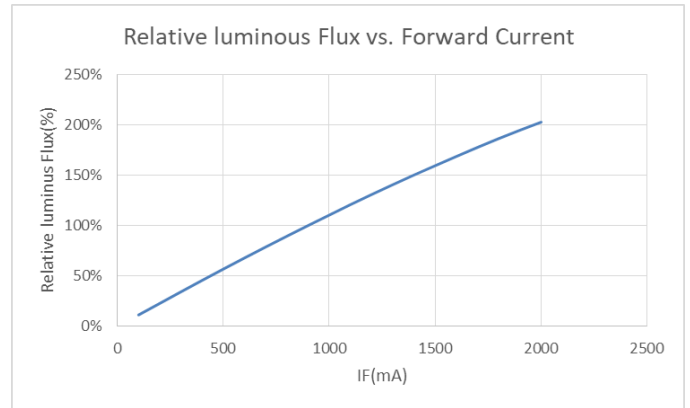
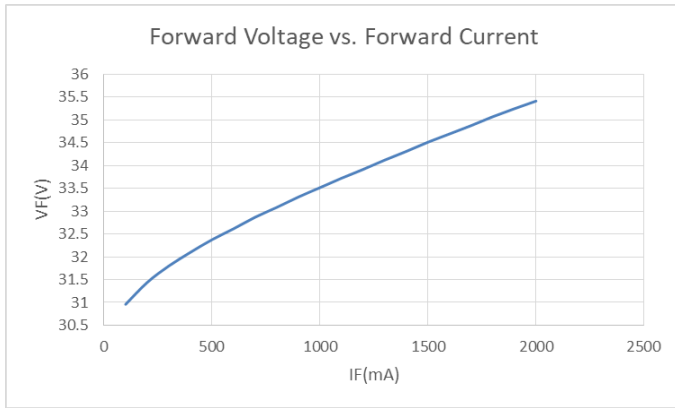

9) 40W_MA2801-12S12P

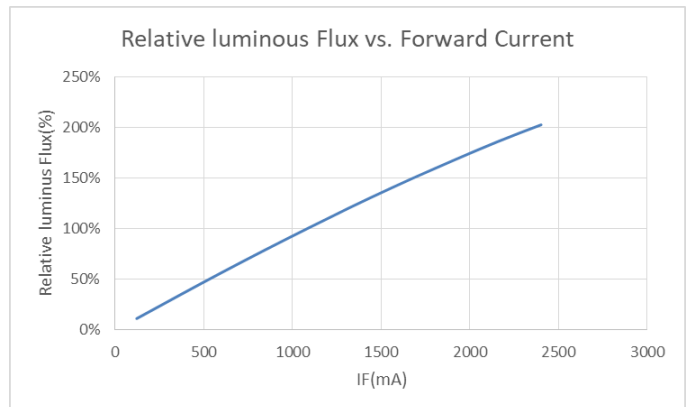
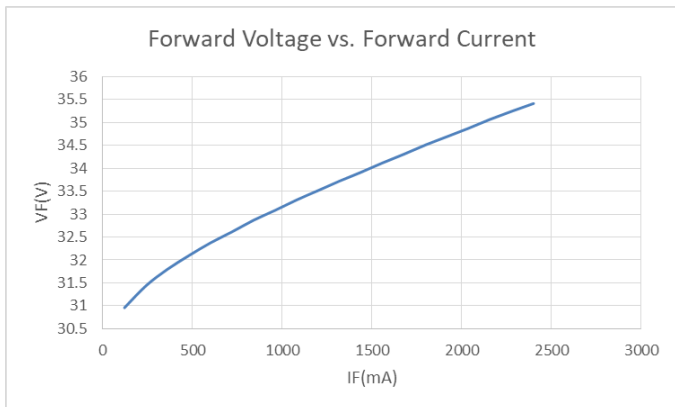

10) 60W_MA2801-18S12P

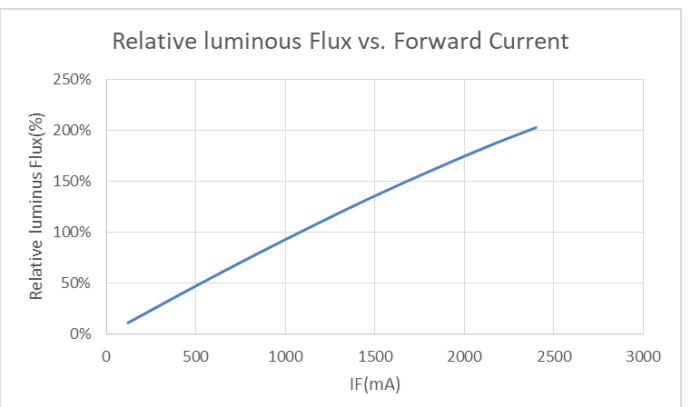
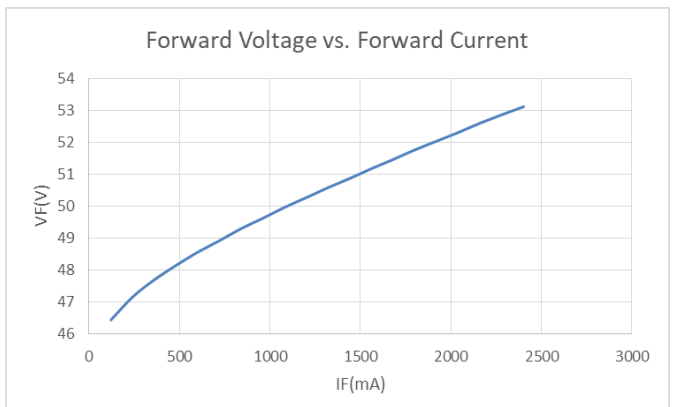

11) 80W_MA2801-18S18P

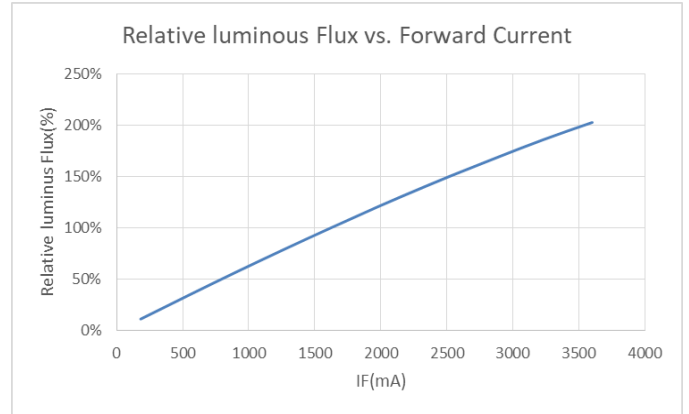
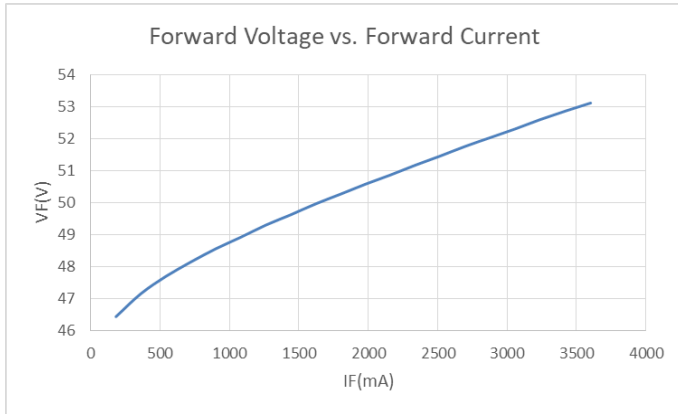

C) 温度特性曲线 Temperature Characteristics
(分选电流) (IF=Sorting Current)

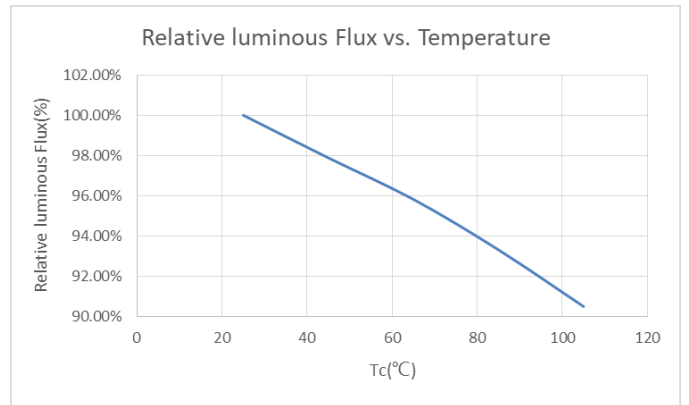
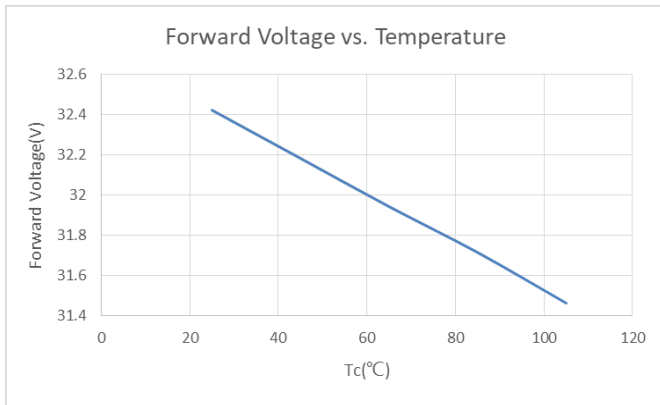

d) 色漂特性 Color Shift Characteristics (Tj=25°C, IF=Sorting Current, Ra80)

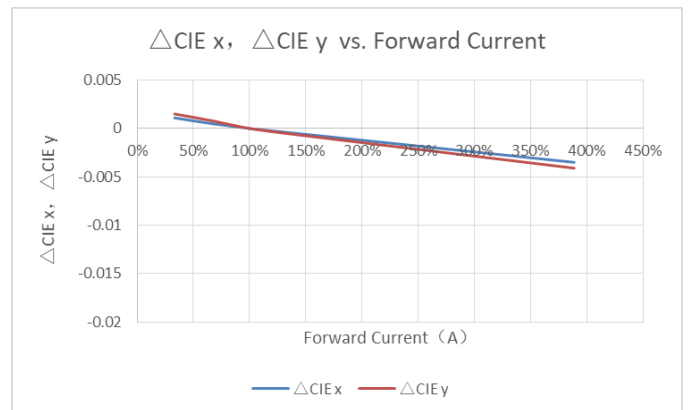
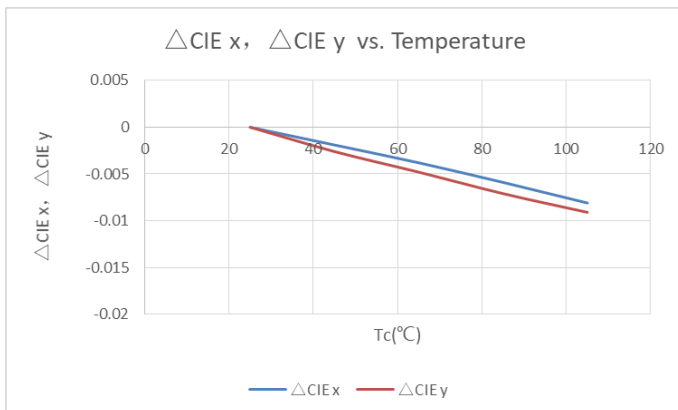

e) Beam Angle Characteristics(IF=Sorting Current, Tj=25°C)

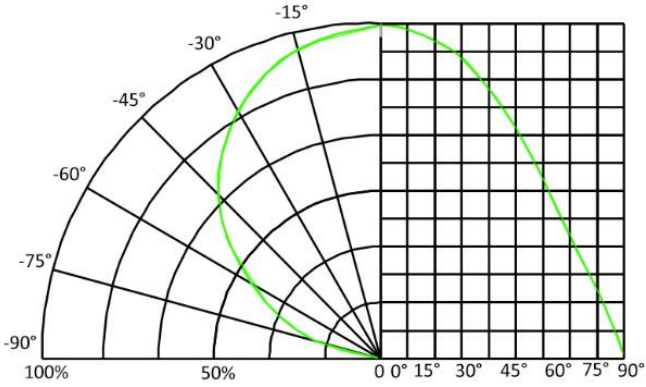

f) Derating Characteristics

1) 3W_MA1301-12S1P

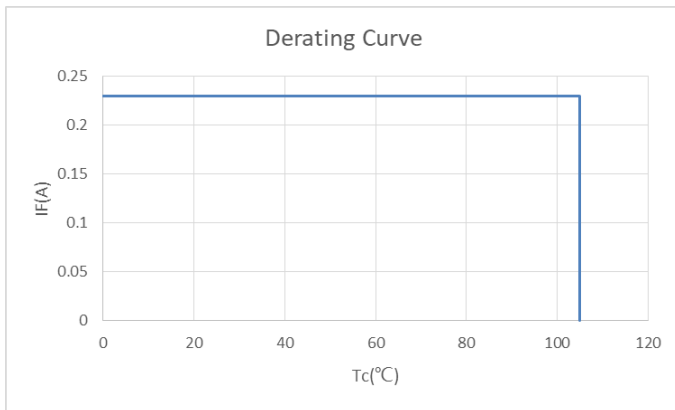

2) 6W_MA1301-12S2P

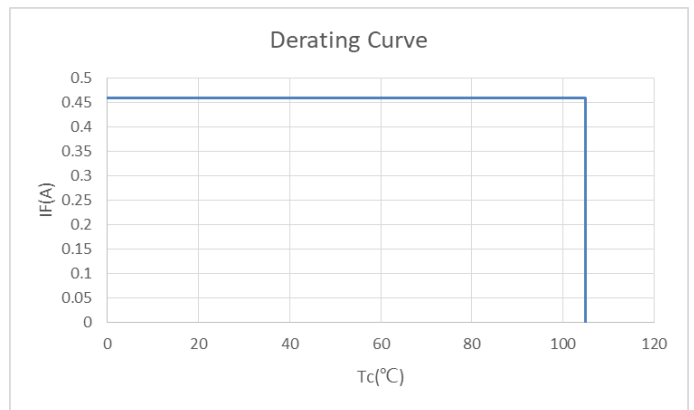

3) 9W_MA1301-12S3P

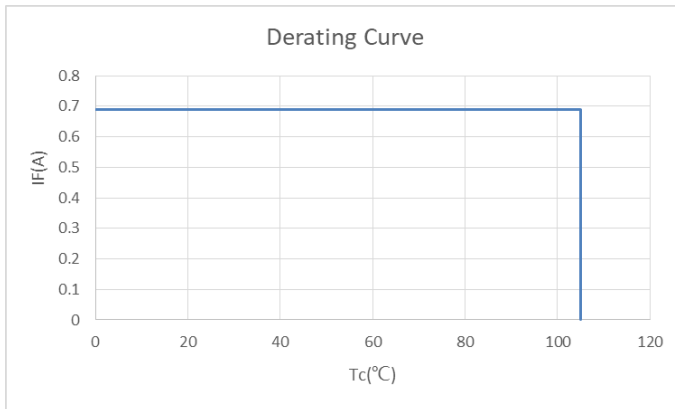

4) 12W_MA1301-12S4P

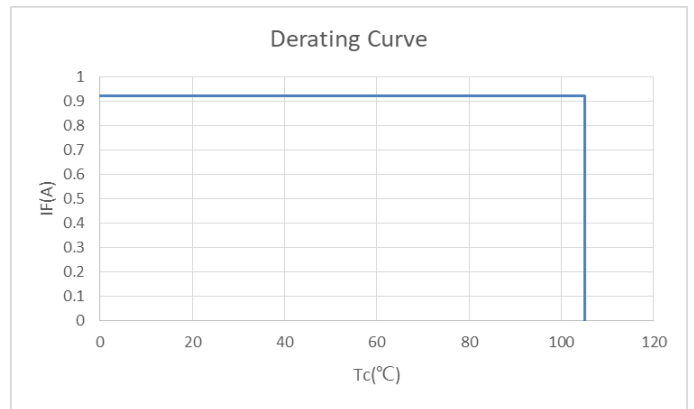

5) 16W_MA1901-12S5P

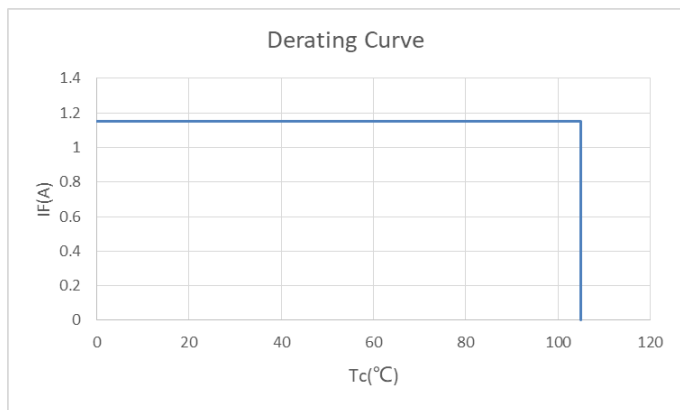

6) 19W_MA1901-12S6P

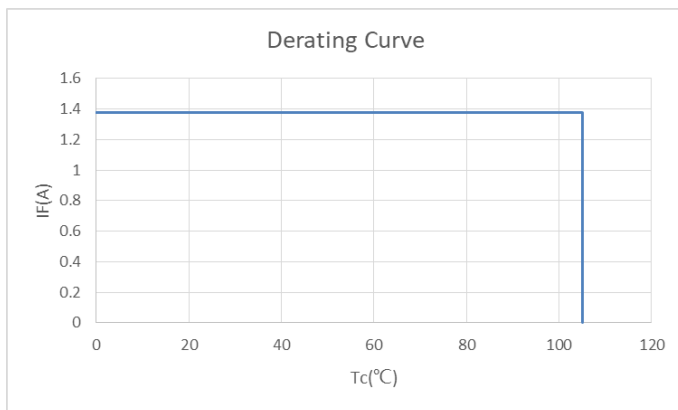

7) 26W_MA1901-12S8P

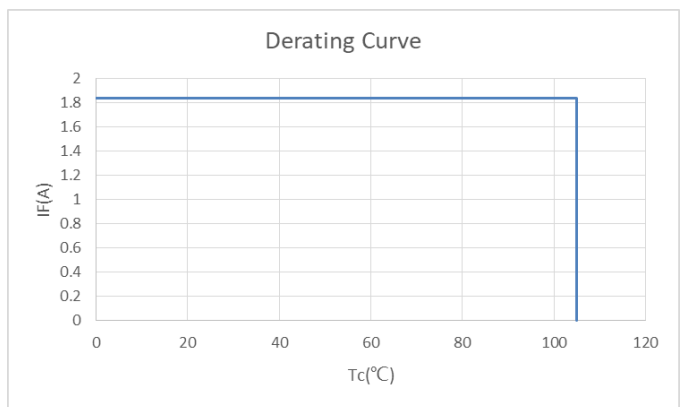

8) 33W_MA1901-12S10P

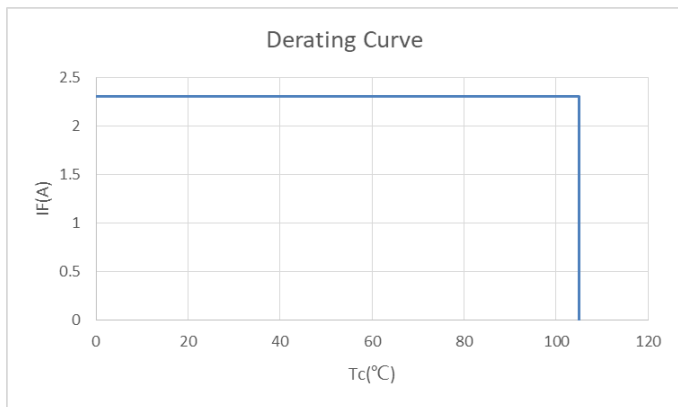

9) 40W_MA2801-12S12P

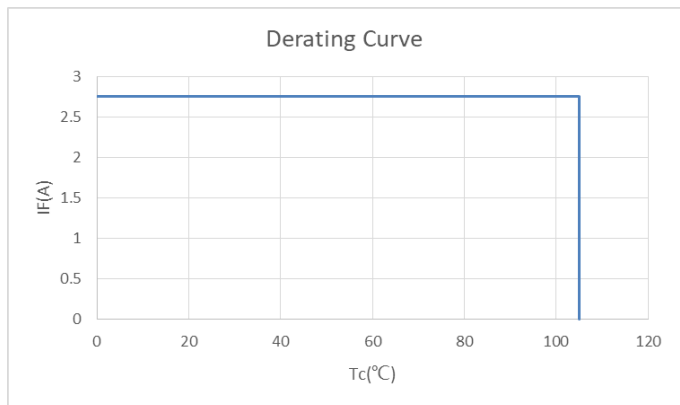

10) 60W_MA2801-18S12P

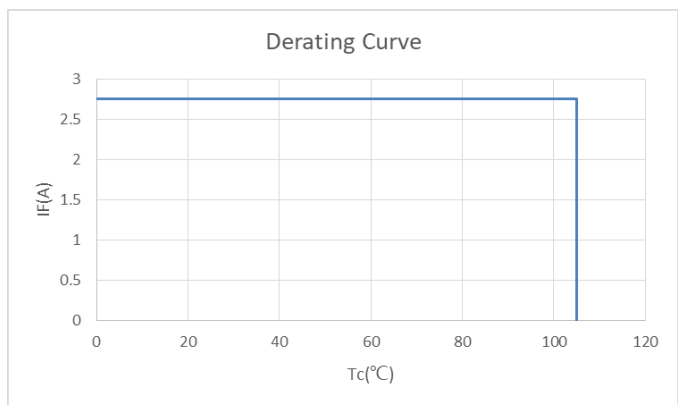

11) 80W_MA2801-18S18P

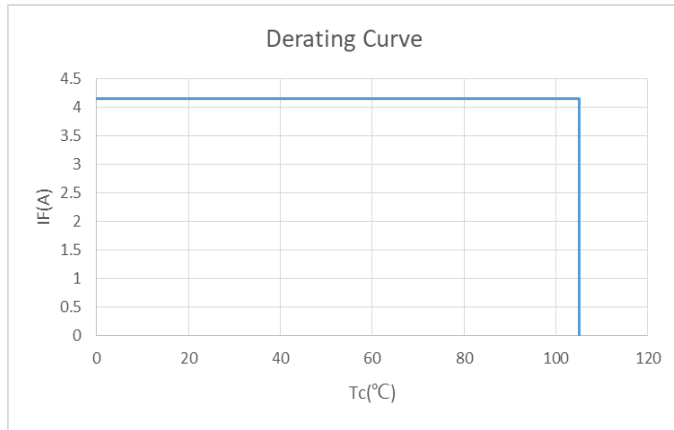

9. Reliability 可靠性

Test Item	Test conditions	Test Duration	Failure Criteria *4	Unites Failed/Tested
Temperature Cycle 温度循环	-40°C(15min) ~125°C (15min) Temperature change within 30sec	100cycles	*2	0/10
High Temperature Storage 高温贮存	Ta=100°C±3°C	1000 hrs	*2	0/10
Low Temperature Storage 低温贮存	Ta=-40°C±3°C	1000 hrs	*2	0/10
Temperature Humidity Storage 高温湿度贮存	Ta=60°C±3°C, RH=90%±3%	1000 hrs	*2	0/10
Life Test 寿命试验	Ta=25°C±3°C, If=*1	1000 hrs	*2	0/10
High Temperature Life Test 高温寿命试验	Ta=85°C±3°C, If=*1	1000 hrs	*2	0/10

Note:

*1 Refer to IF typ.

*2 Failure criteria:

Criteria	Items	Failure Criteria
*4	Forward Voltage (VF) 正向电压	> initial value x1.1 大于 1.1 倍的标称值
	Luminous Flux (φv) 光通量	< initial value x0.7 小于标称值的 70%

10. Packing Specifications 包装规格

➤ MA1301

➤ Packing material ➤ 包装材料	Max. quantity 最大数量	Dimension(mm) 尺寸			
	in pcs of COB COB 数量 (个)	Length 长	Width 宽	Height 高	Tolerance 公差
Tray 托盘	42	198	183	9	2
Anti-Static Bag 静电袋 (最小包装量)	210 (5 Trays)	300	240	-	1
Outer Box 外箱	2940 (14Bags)	365	265	260	5

Tray

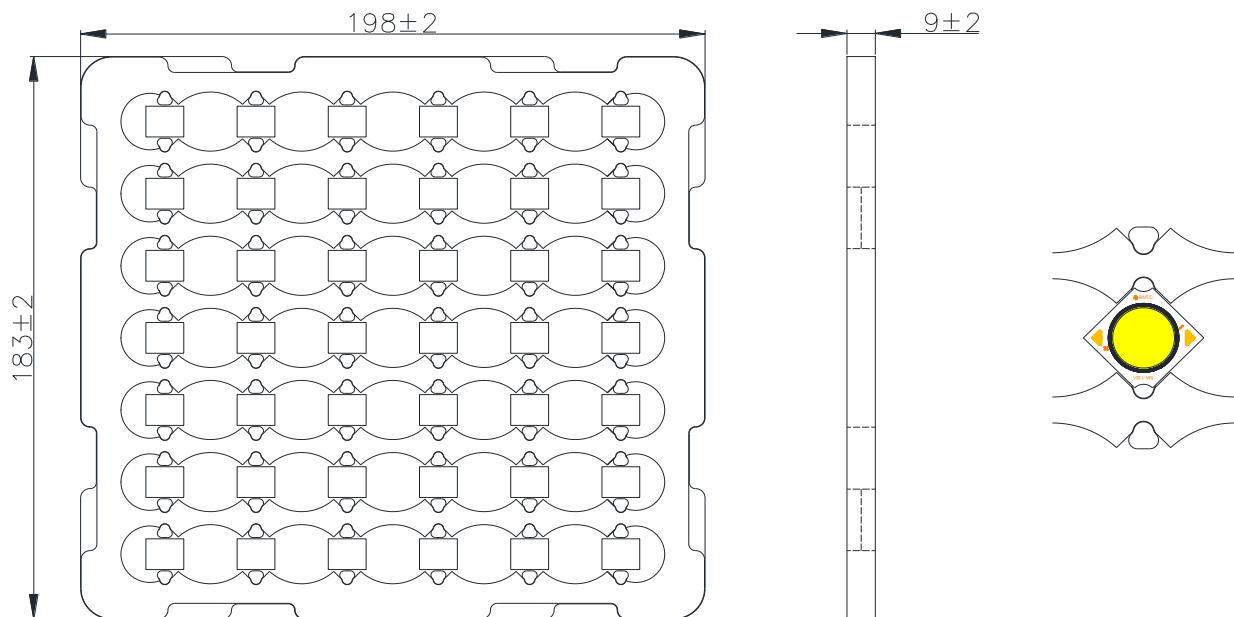

➤ MA1901

➤ Packing material ➤ 包装材料	Max. quantity 最大数量	Dimension(mm) 尺寸			
	in pcs of COB COB 数量 (个)	Length 长	Width 宽	Height 高	Tolerance 公差
Tray 托盘	25	198	183	9	2
Anti-Static Bag 静电袋 (最小包装量)	125 (5 Trays)	300	240	-	1
Outer Box 外箱	1750 (14Bags)	365	265	260	5

Tray

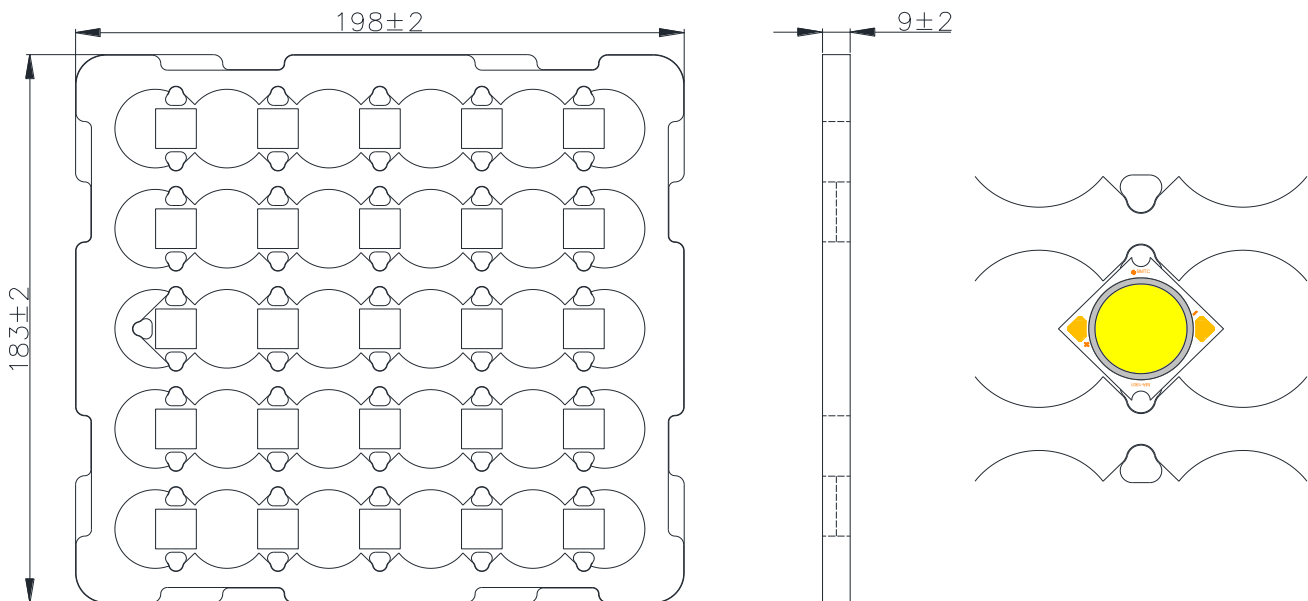

➤ MA2801

Packing material 包装材料	Max. quantity 最大数量	Dimension(mm) 尺寸			
	in pcs of COB COB 数量 (个)	Length 长	Width 宽	Height 高	Tolerance 公差
Tray 托盘	20	198	183	9	2
Anti-Static Bag 静电袋 (最小包装量)	100 (5 Tray)	300	240	-	1
Outer Box (little) 外箱	1400 (14 Bag)	365	265	260	5

Tray

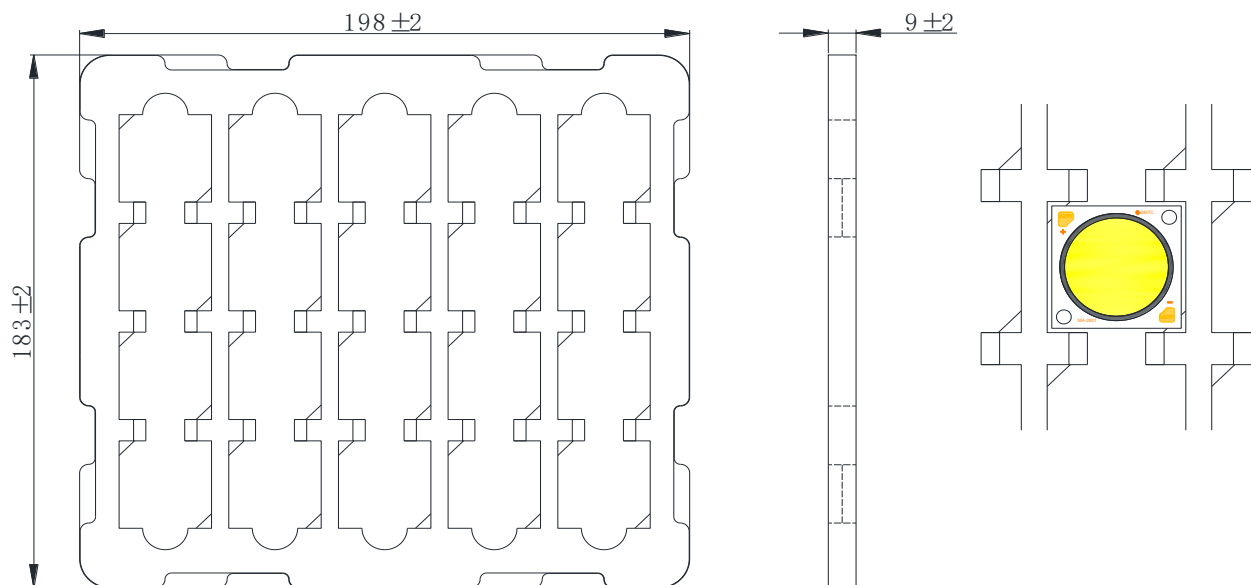

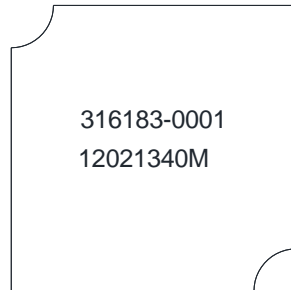

第一行: 316183-0001, BMTC 内部追踪码

第二行: 12021340M

1-4 位: 代表串并信息, 如 1202=12 串 2 并, 与型号编码规则一致

5-6 位: 代表分 bin 信息, 如 13=ANSI, 与型号编码规则一致

7-8 位: 代表色温, 如 40 代表 4000K, 与型号编码规则一致

9 位: 代表显指, 如 M 带表 80 显指, 与型号编码规则一致

11. Handling Precautions 处理注意事项

11.1 Cleaning 清洗

11.1.1 When necessary, cleaning should occur only with isopropyl alcohol (IPA) at room temperature (25°C) for a duration of no more than one minute. Dry at room temperature for 15 minutes before use.

产品如需清洗，只能在室温(25°C)下采用异丙醇(IPA)清洗，清洗时间不超过 1 秒。使用前在室温下放置 15 分钟晾干产品。

11.1.2 The influence of ultrasonic cleaning on the COB depends on factors such as ultrasonic power and the way the COB is mounted. Ultrasonic cleaning should be pre-qualified to ensure this will not cause damage to the COB.

超声波清洗对 COB 的影响取决于超声波功率及 COB 的安装方式等因素。超声波清洗需经过预审合格，以确保此举不会对 COB 造成损害。

11.2. Storage 储存

11.2.1 Don't open moisture barrier bag before the products are ready to use.

产品在准备使用之前，请勿打开防潮袋

11.2.2 Before opening the package: The LEDs should be kept at 30°C or less and 90%RH or less.

防潮袋打开之前：LED应该保存在环境温度30°C（含）以下和相对湿度90%（含）以下环境

11.2.3 After opening the package: The LED's floor life are 24 hours under 30°C or less and 70% RH or less. If unused LEDs remain, it should be stored in moisture proof packages.

防潮袋打开之后：在环境温度30°C（含）以下和相对湿度70%（含）以下，LED的使用时间是24小时；未使用完的LED需使用防潮袋密封包装

11.3 Operating 操作

Compare to epoxy encapsulant that is hard and brittle, silicone is softer and flexible. Although its characteristic significantly reduces thermal stress, it is more susceptible to damage by external mechanical force. As a result, special handling precautions need to be observed during assembly using silicone encapsulated LED products. Failure to comply might leads to damage and premature failure of the LED.

与又硬又脆的环氧封装相比，硅胶更软，更具弹性。尽管它的特性明显降低热应力，但它更

易被外界压力破坏。因此，在使用硅胶封装的 LED 产品时，应该留意安装过程中的一些特殊处理事项。不遵守操作的话可能导致 LED 损坏和失效

11.3.1 Handle the component along the side surfaces by using forceps or appropriate tools.

用镊子或合适的工具夹在元件的侧边

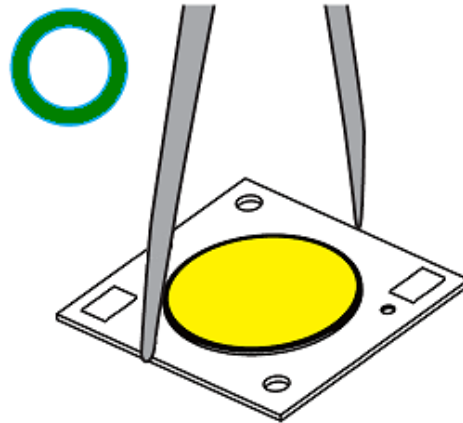

11.3.2 Do not directly touch or handle the silicone lens surface. It may damage the internal circuitry.

请勿直接触摸或操作硅胶透镜表面，这可能会损坏内部的电路

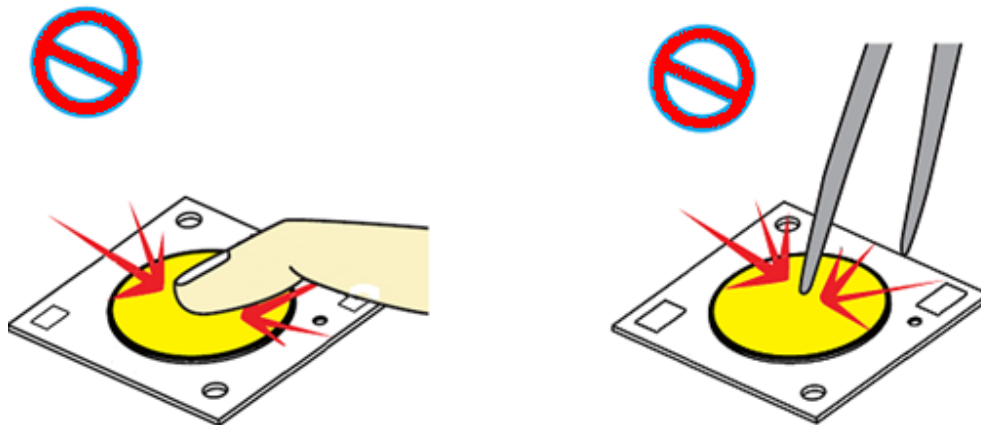

11.3.3 Do not stack the COBs. Impact may scratch the silicone lens or damage the internal circuitry.

请勿将 COB 材料叠成堆。相互间的挤压可能会划伤硅胶透镜表面或损坏内部电路

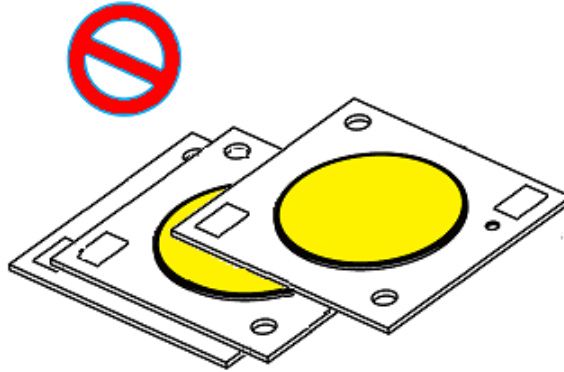

11.3.4 Users should be cautioned not to stare at the light of this LED product. The bright light can damage the eye.

用户应注意，LED 发光时，请勿直视。LED 的强光可能会伤害您的眼睛。

11.4 Chemicals Tested as Harmful 化学测试中的有害物质

In testing, BMTC has found the following chemicals to be harmful to the LEDs. BMTC recommends not using these chemicals anywhere in an LED system. The fumes from even small amounts of these chemicals may damage the LEDs.

经过测试，BMTC发现下列化学品会对LED造成损害，建议不要在任何的LED系统使用这些化学品。即使这些化学品量很少，其所释放的气体也可能会导致LED损害。

- Chemicals that might outgas aromatic hydrocarbons (e.g., toluene, benzene, xylene)
可能会致使芳香烃化合物释气的化学物 (如：甲苯，苯，二甲苯)
- Methyl acetate or ethyl acetate (i.e., nail polish remover)
乙酸甲酯或乙酸乙酯 (如：指甲油清洗剂)
- Cyanoacrylates (i.e., Superglue)
氰基丙烯酸酯 (如：强力胶)
- Glycol ethers (including Precision Electronics Cleaner - propylene glycol monomethyl ether)
乙二醇 (包括精密电子清洗剂-二丙二醇单甲醚)
- Formaldehyde or butadiene
甲醛或丁二烯
- bleach
漂白剂

- Cleaner spray
清洁喷雾剂
- activator
活化剂
- thread locker
螺丝固定胶
- Sulfur, bromide, iodine , chloride
硫, 溴, 碘, 氯

11.5 ESD Protection During Production 生产过程中的静电保护

Electric static discharge can result when static-sensitive products come in contact with the operator or other conductors.

当操作人员或者其他导体接触静电敏感材料时，容易产生静电放电。

The following procedures may decrease the possibility of ESD damage:

以下操作可降低静电破坏的可能性

11.5.1 Minimize friction between the product and surroundings to avoid static buildup.

将产品和外界之间的摩擦减到最低以避免静电产生

11.5.2 All production machinery and test instruments must be electrically grounded.

所有的产品设备和测试仪器必须接地

11.5.3 Operators must wear anti-static bracelets.

操作人员必须配戴静电环

11.5.4 Wear anti-static suit when entering work areas with conductive machinery.

进入带电设备工作区域时需穿防静电服

11.5.5 Set up ESD protection areas using grounded metal plating for component handling.

使用经电镀处理的金属部件接地从而建立 ESD 保护区域

11.5.6 All workstations that handle IC and ESD-sensitive components must maintain an electrostatic potential of 150V or less.

所有操作 IC 和 ESD 敏感器件元器件的工作台必须保持低于 150V 的静电保护

11.5.7 Maintain a humidity level of 50% or higher in production areas.

产品区域环境需保持高于 50% 的湿度水平

11.5.8 Use anti-static packaging for transport and storage.

运输和储存需使用防静电包装

11.5.9 All anti-static equipment and procedures should be periodically inspected and



evaluated for proper functionality.

防静电设备及相关操作应该定期检查及评估以确保运行正常

11.6 Thermal Management 热管理

11.6.1 Thermal design of the end product is of paramount importance. Please consider the heat generation of the LED when making the system design. The coefficient of temperature increase per input electric power is affected by the thermal resistance of the circuit board and density of LED placement on the board, as well as other components. It is necessary to avoid intense heat generation and operate within the maximum ratings given in this specification.

终端产品的散热设计是极其重要的。在做整体设计时请考虑 LED 的热量处理。单位输入功率的温度系数的增加受线路板的热阻，LED 在板上布置的密度和其他元器件的影响。避免热量积累和在本规格书中指定的最大额定范围内操作是必要的

11.6.2 The equation ① indicates correlation between Tj and Ta, and the equation ② indicates correlation between Tj and Ts

等式①表明 Tj 和 Ta 的相互关系，等式②表明 Tj 和 Tc 的相互关系

$$T_j = T_a + R_{thj-a} * W \quad \text{.....} \quad \text{①}$$

$$T_j = T_c + R_{thj-c} * W \quad \text{.....} \quad \text{②}$$

Tj = dice junction temperature: °C Tj = 晶片结点温度: °C

Ta = ambient temperature: °C Ta = 环境温度: °C

Tc = substrate test point temperature: °C Tc = 基板测试点温度: °C

Rth j-a = heat resistance from dice junction temperature to ambient temperature : °C / W

Rth j-a = 晶片结温至环境温度之间的热阻: °C/W

Rth j-c = heat resistance from dice junction temperature to Ts measuring point : °C / W

Rth j-c = 晶片结温至 Ts 测量点之间的热阻: °C/W

W = inputting power (IFx VF) : W

W = 输入功率 (IFx VF) : W

11.6.3 Thermal model 热模型

shows a thermal model for a single COB mounted to a heat sink.

显示单一 COB 材料到散热器的热传导模型

