

- RoHs Compliant and Halogen-Free ①
- Integrated Monolithic Schottky Diode
- Low Profile (<0.7 mm)
- Dual Sided Cooling Compatible ①
- Ultra Low Package Inductance
- Optimized for High Frequency Switching ①
- Ideal for CPU Core DC-DC Converters
- Optimized for Sync. FET socket of Sync. Buck Converter①
- Low Conduction and Switching Losses
- Compatible with existing Surface Mount Techniques ①
- 100% Rg tested

### HEXFET® Power MOSFET plus Schottky Diode ②

Typical values (unless otherwise specified)

$V_{DS}$	$V_{GS}$	$R_{DS(on)}$	$R_{DS(on)}$		
30V max	±20V max	1.4mΩ @ 10V	2.2mΩ @ 4.5V		
$Q_{g\ tot}$	$Q_{gd}$	$Q_{gs2}$	$Q_{rr}$	$Q_{oss}$	$V_{gs(th)}$
35nC	8.9nC	5.1nC	40nC	29nC	1.8V

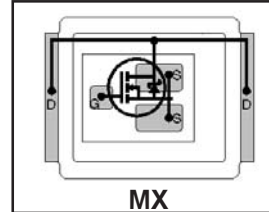

Applicable DirectFET Outline and Substrate Outline (see p.7,8 for details)①

SQ	SX	ST		MQ	<b>MX</b>	MT	MP			
----	----	----	--	----	-----------	----	----	--	--	--

### Description

The IRF8302MPbF combines the latest HEXFET® Power MOSFET Silicon technology with the advanced DirectFET® packaging to achieve the lowest on-state resistance in a package that has the footprint of a SO-8 and only 0.7 mm profile. The DirectFET® package is compatible with existing layout geometries used in power applications, PCB assembly equipment and vapor phase, infra-red or convection soldering techniques. Application note AN-1035 is followed regarding the manufacturing methods and processes. The DirectFET® package allows dual sided cooling to maximize thermal transfer in power systems, improving previous best thermal resistance by 80%.

The IRF8302MPbF balances industry leading on-state resistance while minimizing gate charge along with ultra low package inductance to reduce both conduction and switching losses. This part contains an integrated Schottky diode to reduce the  $Q_{rr}$  of the body drain diode further reducing the losses in a Synchronous Buck circuit. The reduced losses make this product ideal for high frequency/high efficiency DC-DC converters that power high current loads such as the latest generation of microprocessors. The IRF8302MPbF has been optimized for parameters that are critical in synchronous buck converter's Sync FET sockets.

Base Part number	Package Type	Standard Pack		Orderable Part Number
		Form	Quantity	
IRF8302MPbF	DirectFET MX	Tape and Reel	4800	IRF8302MTRPbF

### Absolute Maximum Ratings

	Parameter	Max.	Units
$V_{DS}$	Drain-to-Source Voltage	30	V
$V_{GS}$	Gate-to-Source Voltage	±20	
$I_D @ T_A = 25^\circ C$	Continuous Drain Current, $V_{GS} @ 10V$ ③	31	A
$I_D @ T_A = 70^\circ C$	Continuous Drain Current, $V_{GS} @ 10V$ ③	25	
$I_D @ T_C = 25^\circ C$	Continuous Drain Current, $V_{GS} @ 10V$ ④	190	
$I_{DM}$	Pulsed Drain Current ⑤	250	
$E_{AS}$	Single Pulse Avalanche Energy ⑥	260	mJ
$I_{AR}$	Avalanche Current ⑤	25	A

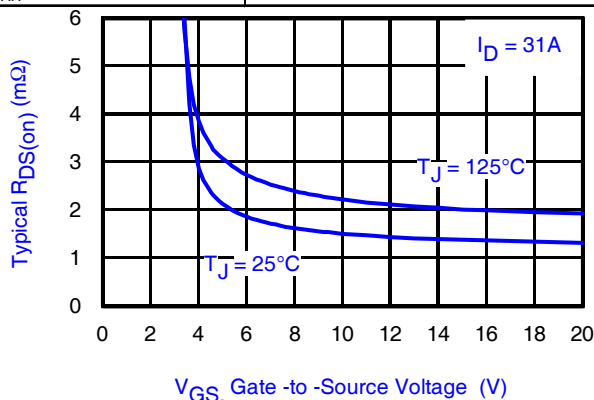

Fig 1. Typical On-Resistance vs. Gate Voltage

Notes:

- ① Click on this section to link to the appropriate technical paper.
- ② Click on this section to link to the DirectFET Website.
- ③ Surface mounted on 1 in. square Cu board, steady state.

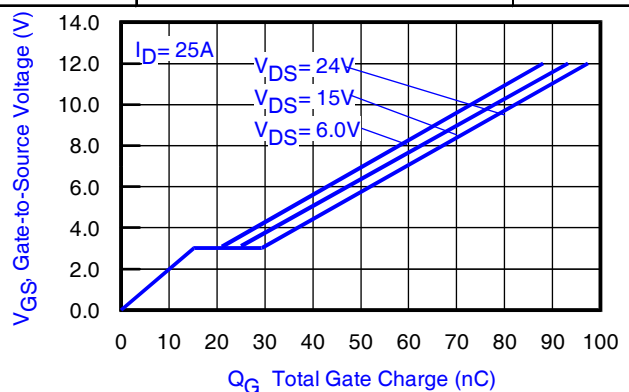

Fig 2. Typical Total Gate Charge vs. Gate-to-Source Voltage

- ④  $T_C$  measured with thermocouple mounted to top (Drain) of part.
- ⑤ Repetitive rating; pulse width limited by max. junction temperature.
- ⑥ Starting  $T_J = 25^\circ C$ ,  $L = 0.83mH$ ,  $R_G = 25\Omega$ ,  $I_{AS} = 25A$ .

**Static @  $T_J = 25^\circ\text{C}$  (unless otherwise specified)**

	Parameter	Min.	Typ.	Max.	Units	Conditions
$BV_{DSS}$	Drain-to-Source Breakdown Voltage	30	—	—	V	$V_{GS} = 0V, I_D = 1.0mA$
$\Delta BV_{DSS}/\Delta T_J$	Breakdown Voltage Temp. Coefficient	—	4.0	—	mV/°C	Reference to $25^\circ\text{C}, I_D = 10mA$
$R_{DS(on)}$	Static Drain-to-Source On-Resistance	—	1.4	1.8	m $\Omega$	$V_{GS} = 10V, I_D = 31A$ ⑦
		—	2.2	2.7		$V_{GS} = 4.5V, I_D = 25A$ ⑦
$V_{GS(th)}$	Gate Threshold Voltage	1.35	1.8	2.35	V	$V_{DS} = V_{GS}, I_D = 150\mu A$
$\Delta V_{GS(th)}/\Delta T_J$	Gate Threshold Voltage Coefficient	—	-4.2	—	mV/°C	$V_{DS} = V_{GS}, I_D = 10mA$
$I_{DSS}$	Drain-to-Source Leakage Current	—	—	100	$\mu A$	$V_{DS} = 24V, V_{GS} = 0V$
		—	—	5.0	mA	$V_{DS} = 24V, V_{GS} = 0V, T_J = 125^\circ\text{C}$
$I_{GSS}$	Gate-to-Source Forward Leakage	—	—	100	nA	$V_{GS} = 20V$
	Gate-to-Source Reverse Leakage	—	—	-100	nA	$V_{GS} = -20V$
$g_{fs}$	Forward Transconductance	120	—	—	S	$V_{DS} = 15V, I_D = 25A$
$Q_g$	Total Gate Charge	—	35	53	nC	$V_{DS} = 15V$ $V_{GS} = 4.5V$ $I_D = 25A$ See Fig. 15
$Q_{gs1}$	Pre-Vth Gate-to-Source Charge	—	11	—		
$Q_{gs2}$	Post-Vth Gate-to-Source Charge	—	5.1	—		
$Q_{gd}$	Gate-to-Drain Charge	—	8.9	—		
$Q_{godr}$	Gate Charge Overdrive	—	10	—		
$Q_{sw}$	Switch Charge ( $Q_{gs2} + Q_{gd}$ )	—	14	—	nC	$V_{DS} = 16V, V_{GS} = 0V$
$R_G$	Gate Resistance	—	1.3	2.2	$\Omega$	
$t_{d(on)}$	Turn-On Delay Time	—	22	—	ns	$V_{DD} = 15V, V_{GS} = 4.5V$ ⑦ $I_D = 25A$ $R_G = 1.8\Omega$ See Fig. 17
$t_r$	Rise Time	—	37	—		
$t_{d(off)}$	Turn-Off Delay Time	—	20	—		
$t_f$	Fall Time	—	15	—		
$C_{iss}$	Input Capacitance	—	6030	—	pF	$V_{GS} = 0V$ $V_{DS} = 15V$ $f = 1.0MHz$
$C_{oss}$	Output Capacitance	—	1360	—		
$C_{rss}$	Reverse Transfer Capacitance	—	560	—		

**Diode Characteristics**

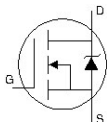
	Parameter	Min.	Typ.	Max.	Units	Conditions
$I_S$	Continuous Source Current (Body Diode)	—	—	31	A	MOSFET symbol showing the integral reverse p-n junction diode. 
$I_{SM}$	Pulsed Source Current (Body Diode) ⑤	—	—	250		
$V_{SD}$	Diode Forward Voltage	—	—	0.80	V	$T_J = 25^\circ\text{C}, I_S = 25A, V_{GS} = 0V$ ⑦
$t_{rr}$	Reverse Recovery Time	—	30	45	ns	$T_J = 25^\circ\text{C}, I_F = 25A$
$Q_{rr}$	Reverse Recovery Charge	—	40	60	nC	$di/dt = 300A/\mu s$ ⑦

**Notes:**

 ⑦ Pulse width  $\leq 400\mu s$ ; duty cycle  $\leq 2\%$ .

**Absolute Maximum Ratings**

	Parameter	Max.	Units
$P_D @ T_A = 25^\circ\text{C}$	Power Dissipation ③	2.8	W
$P_D @ T_A = 70^\circ\text{C}$	Power Dissipation ③	1.8	
$P_D @ T_C = 25^\circ\text{C}$	Power Dissipation ④	104	
$T_P$	Peak Soldering Temperature	270	°C
$T_J$	Operating Junction and	-40 to + 150	
$T_{STG}$	Storage Temperature Range		

**Thermal Resistance**

	Parameter	Typ.	Max.	Units
$R_{\theta JA}$	Junction-to-Ambient ③④	—	45	°C/W
$R_{\theta JA}$	Junction-to-Ambient ③④	12.5	—	
$R_{\theta JA}$	Junction-to-Ambient ⑤⑥	20	—	
$R_{\theta JC}$	Junction-to-Case ④⑥	—	1.2	
$R_{\theta J-PCB}$	Junction-to-PCB Mounted	1.0	—	
	Linear Derating Factor ③	0.022		W/°C

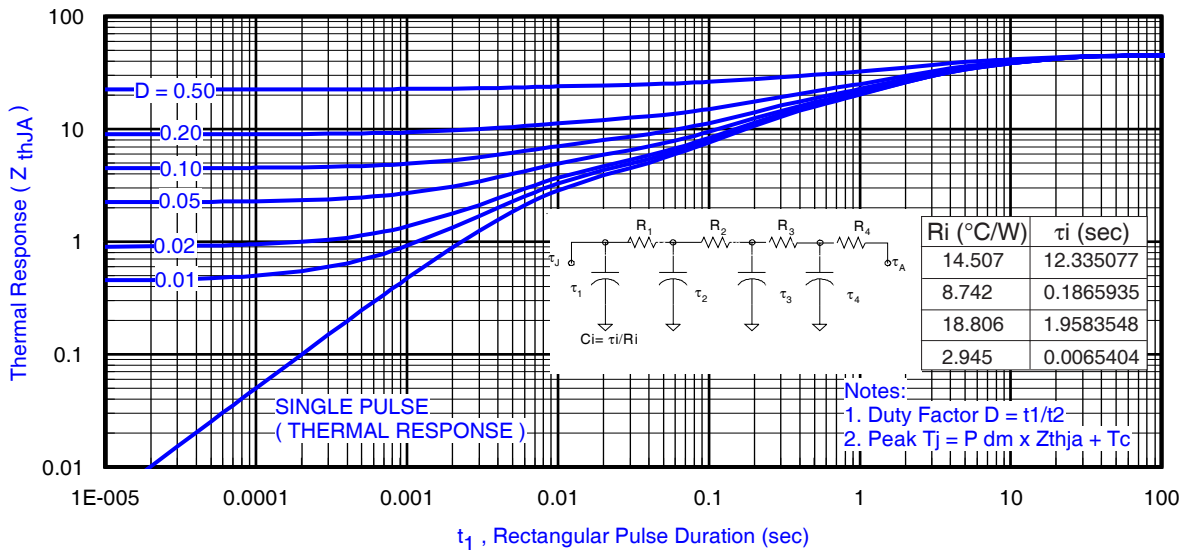

**Fig 3. Maximum Effective Transient Thermal Impedance, Junction-to-Ambient ③**  
 (At lower pulse widths  $Z_{thJA}$  &  $Z_{thJC}$  are combined)

**Notes:**

- ③ Used double sided cooling, mounting pad with large heatsink.
- ④  $R_{\theta}$  is measured at  $T_J$  of approximately  $90^\circ\text{C}$ .
- ⑤ Mounted on minimum footprint full size board with metalized back and with small clip heatsink.

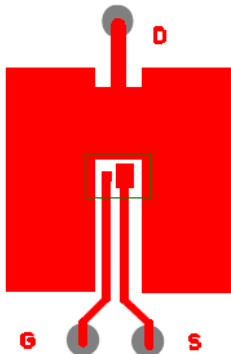

③ Surface mounted on 1 in. square Cu (still air).

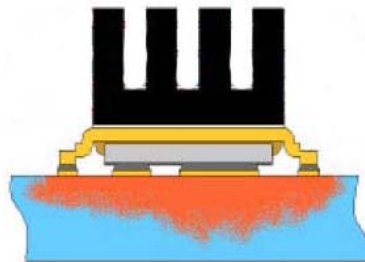

④ Mounted to a PCB with small clip heatsink (still air)

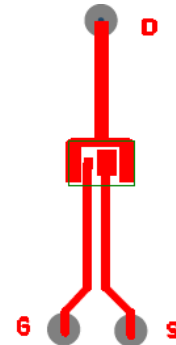

⑤ Mounted on minimum footprint full size board with metalized back and with small clip heatsink (still air)

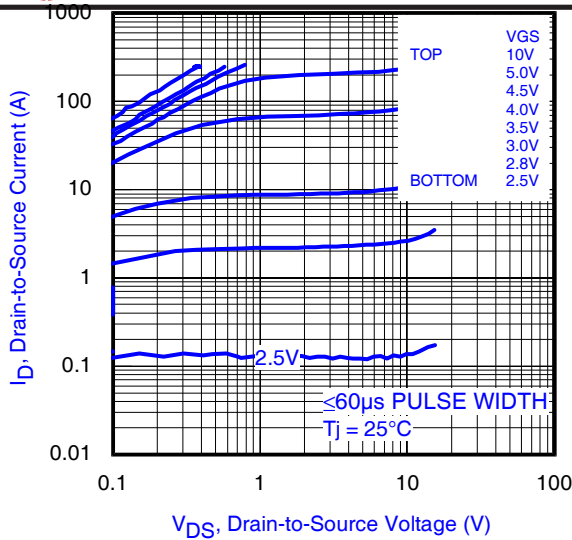
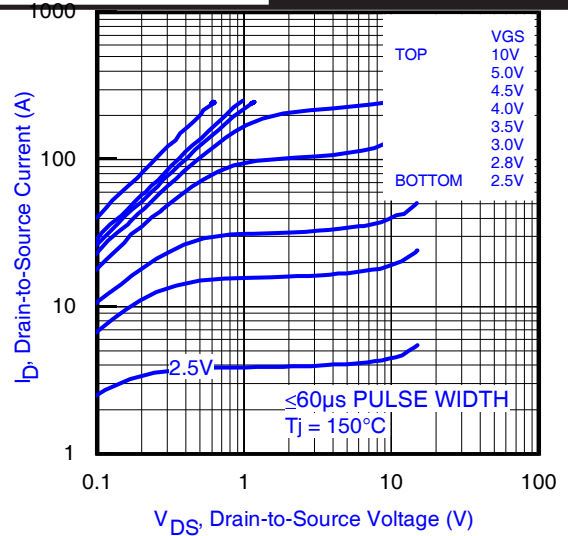
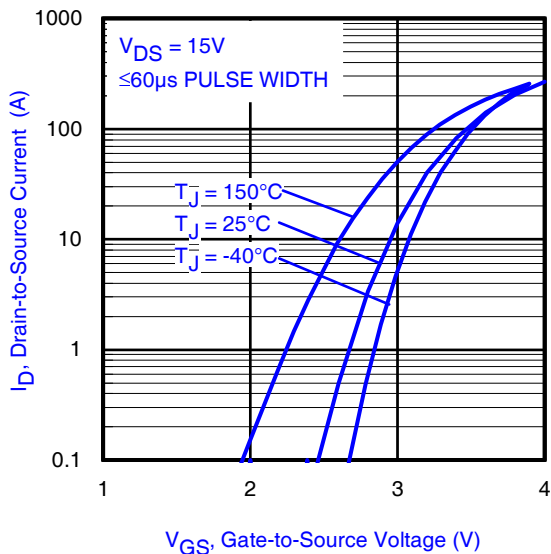
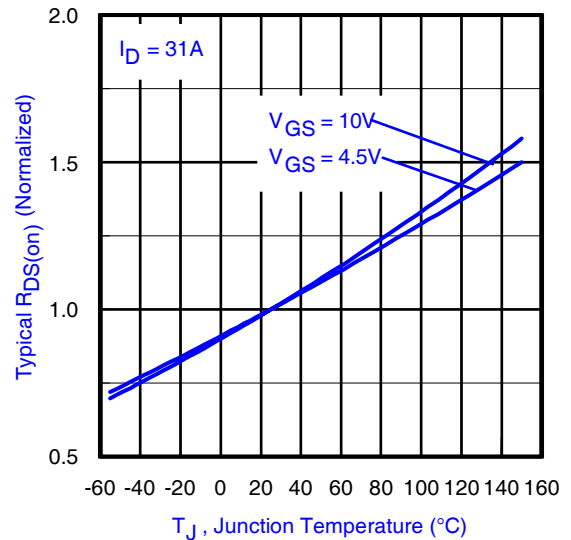
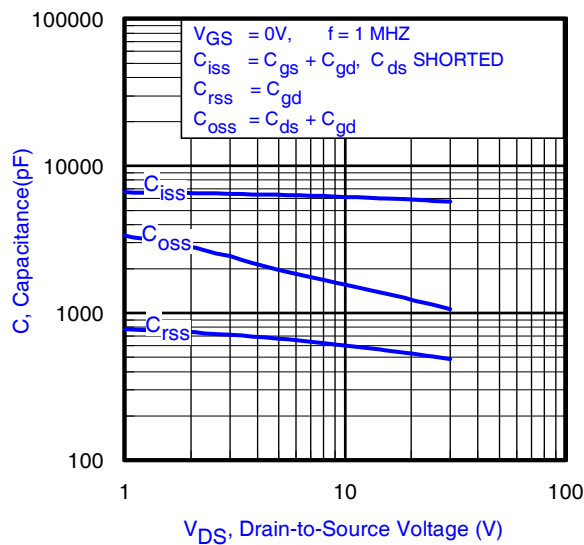
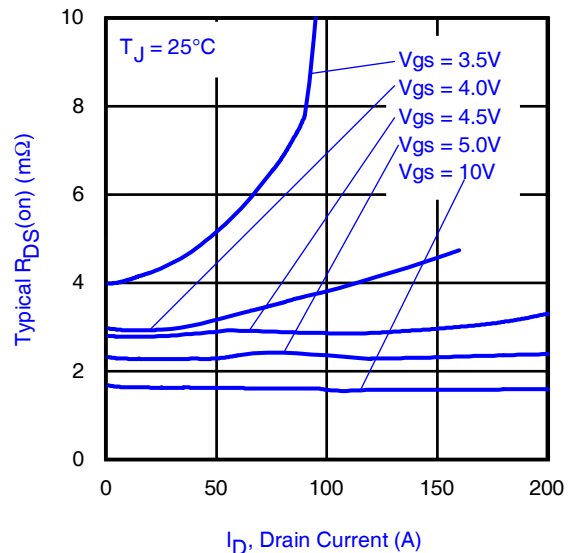
**Fig 4. Typical Output Characteristics**

**Fig 5. Typical Output Characteristics**

**Fig 6. Typical Transfer Characteristics**

**Fig 7. Normalized On-Resistance vs. Temperature**

**Fig 8. Typical Capacitance vs. Drain-to-Source Voltage**

**Fig 9. Typical On-Resistance vs. Drain Current and Gate Voltage**

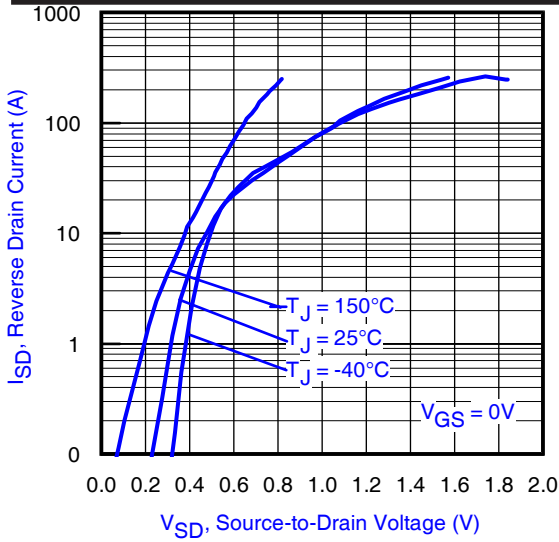

Fig 10. Typical Source-Drain Diode Forward Voltage

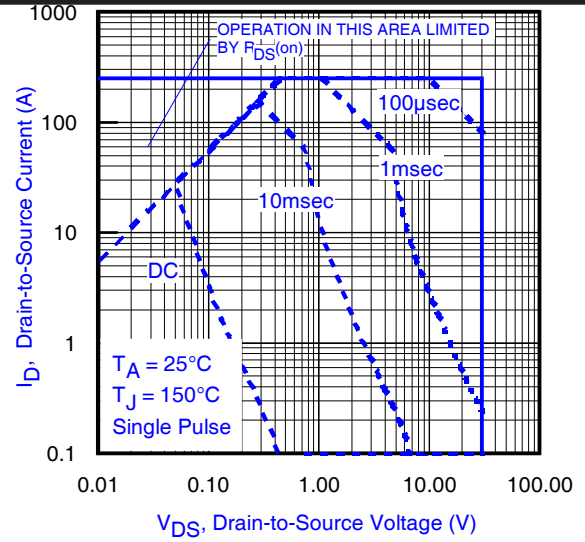

Fig 11. Maximum Safe Operating Area

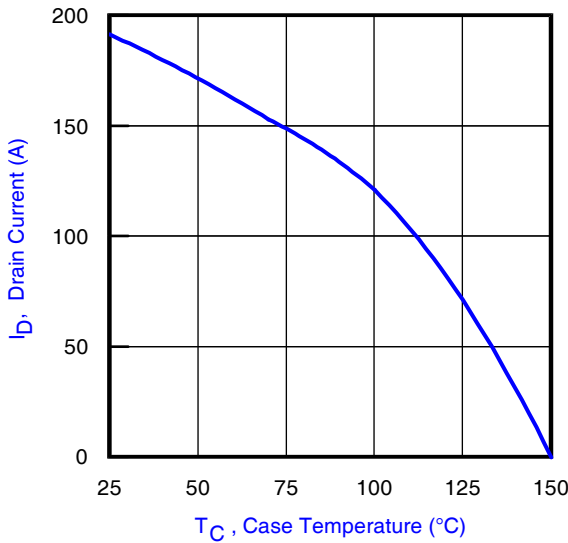

Fig 12. Maximum Drain Current vs. Case Temperature

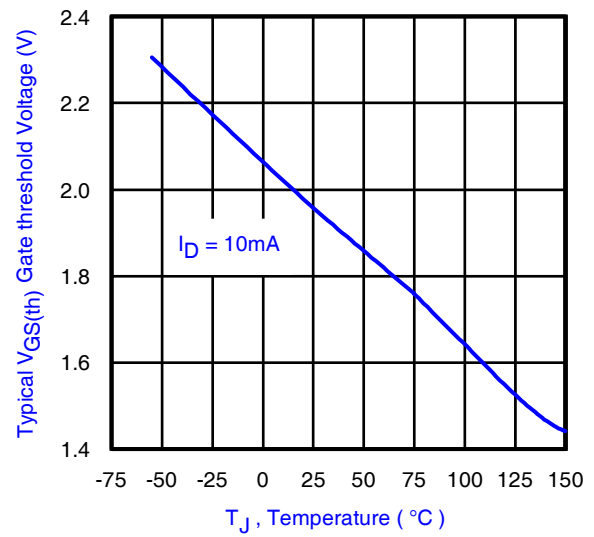

Fig 13. Typical Threshold Voltage vs. Junction Temperature

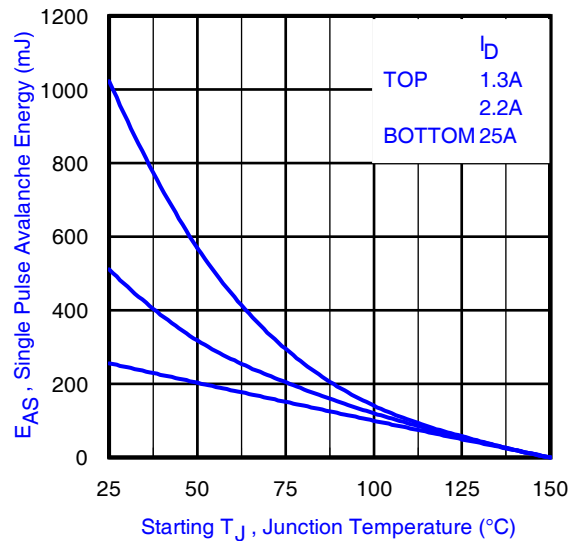

Fig 14. Maximum Avalanche Energy vs. Drain Current



Fig 15a. Gate Charge Test Circuit



Fig 15b. Gate Charge Waveform

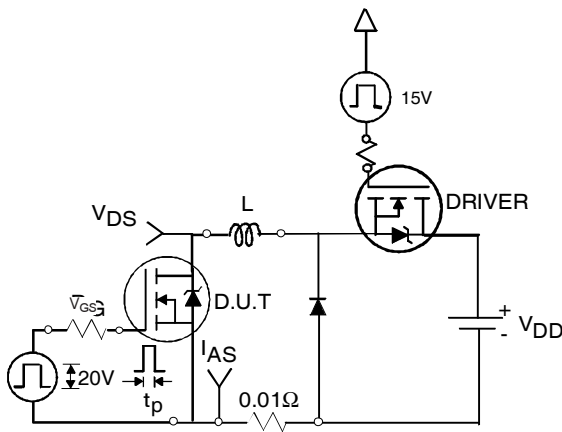

Fig 16a. Unclamped Inductive Test Circuit

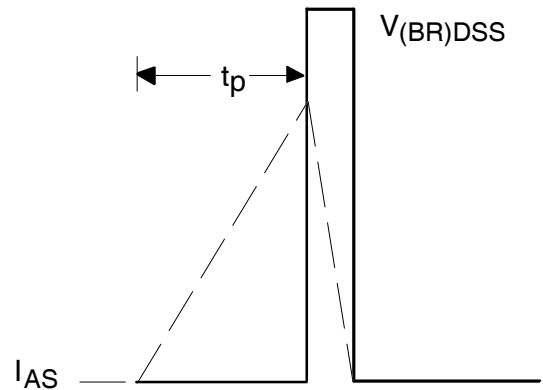

Fig 16b. Unclamped Inductive Waveforms

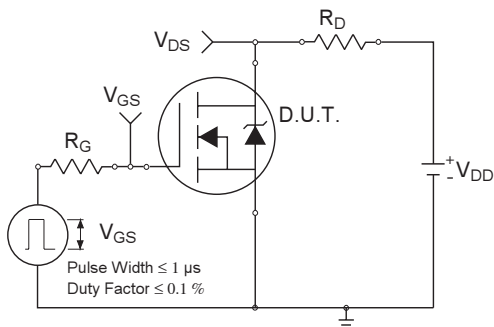

Fig 17a. Switching Time Test Circuit

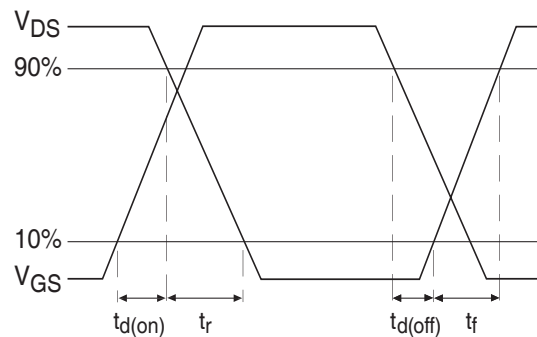
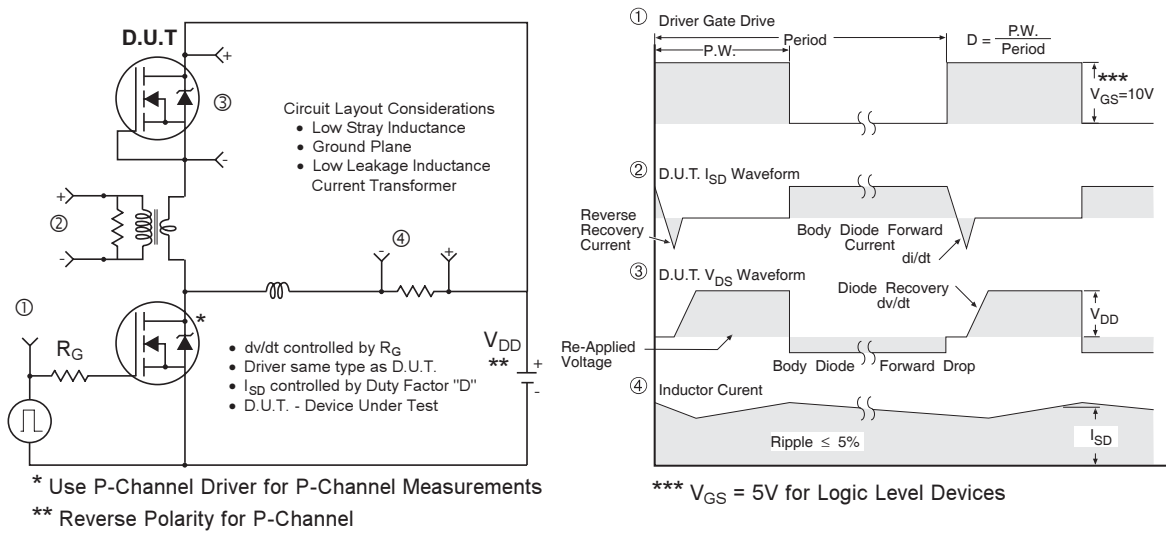

Fig 17b. Switching Time Waveforms



**Fig 18.** Diode Reverse Recovery Test Circuit for HEXFET® Power MOSFETs

### DirectFET® Board Footprint, MX Outline (Medium Size Can, X-Designation).

Please see DirectFET application note AN-1035 for all details regarding the assembly of DirectFET. This includes all recommendations for stencil and substrate designs.

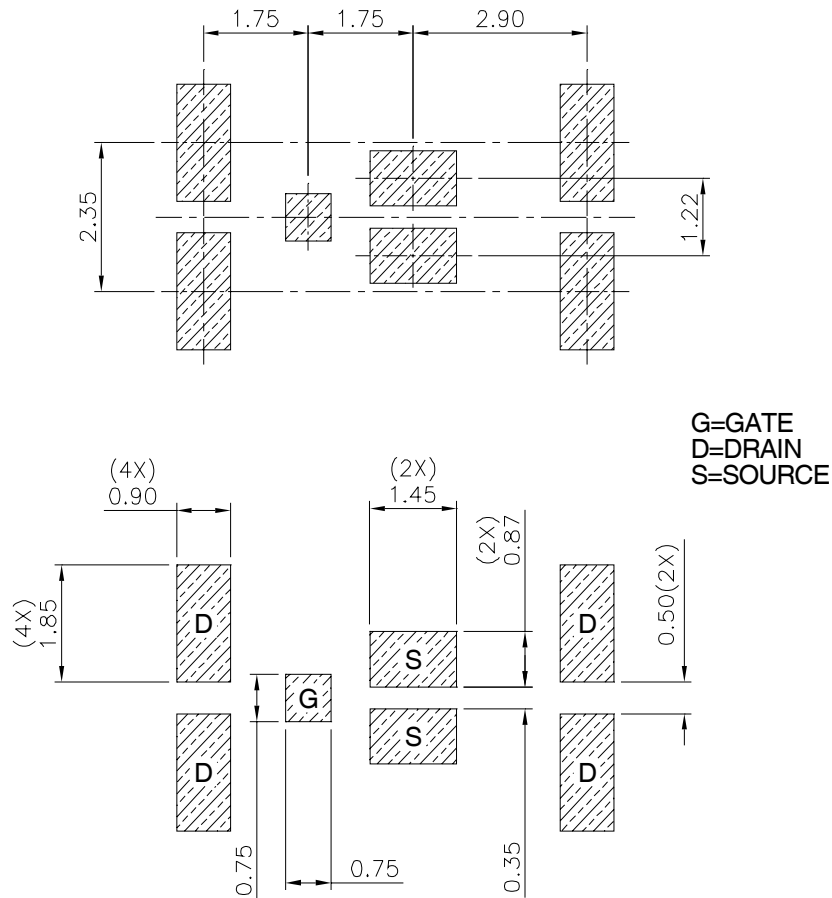

### DirectFET® Outline Dimension, MX Outline (Medium Size Can, X-Designation).

Please see DirectFET application note AN-1035 for all details regarding the assembly of DirectFET. This includes all recommendations for stencil and substrate designs.

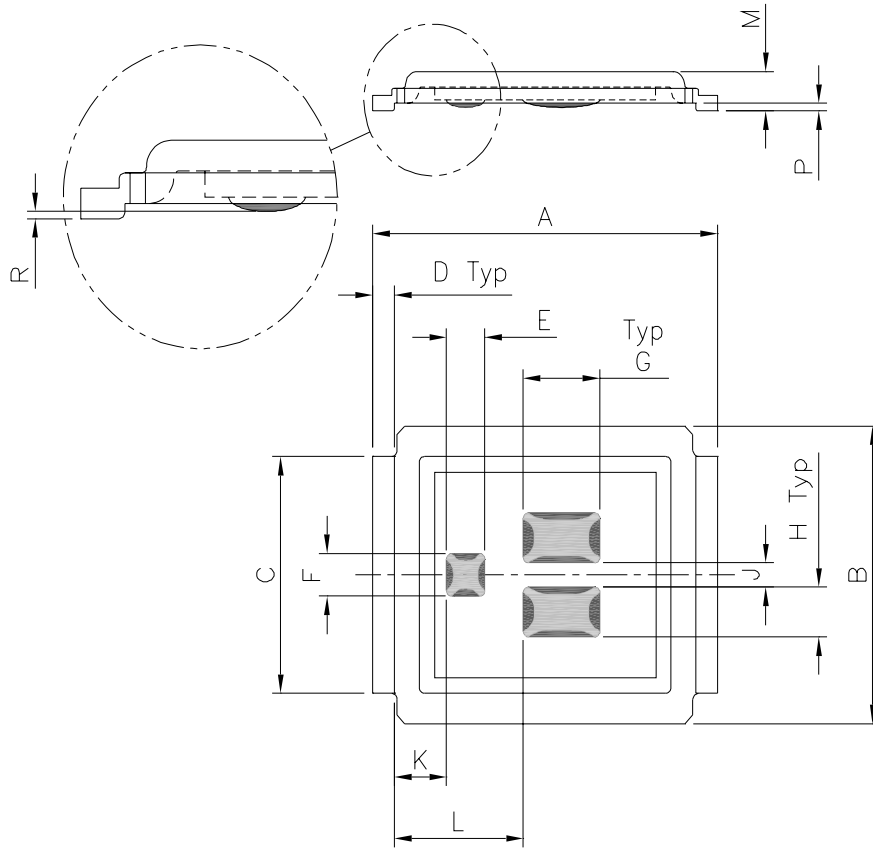

DIMENSIONS				
CODE	METRIC		IMPERIAL	
	MIN	MAX	MIN	MAX
A	6.25	6.35	0.246	0.250
B	4.80	5.05	0.189	0.199
C	3.85	3.95	0.152	0.156
D	0.35	0.45	0.014	0.018
E	0.68	0.72	0.027	0.028
F	0.68	0.72	0.027	0.028
G	1.38	1.42	0.054	0.056
H	0.80	0.84	0.032	0.033
J	0.38	0.42	0.015	0.017
K	0.88	1.01	0.035	0.039
L	2.28	2.41	0.090	0.095
M	0.59	0.70	0.023	0.028
R	0.020	0.080	0.0008	0.0031
P	0.08	0.17	0.003	0.007

### DirectFET® Part Marking

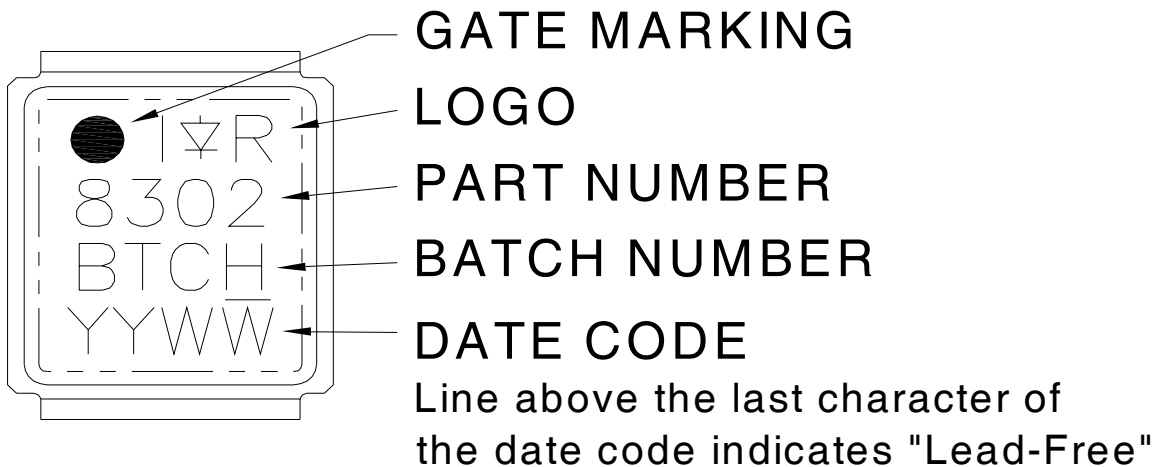

Note: For the most current drawing please refer to IR website at <http://www.irf.com/package/>



DirectFET® Tape & Reel Dimension (Showing component orientation).

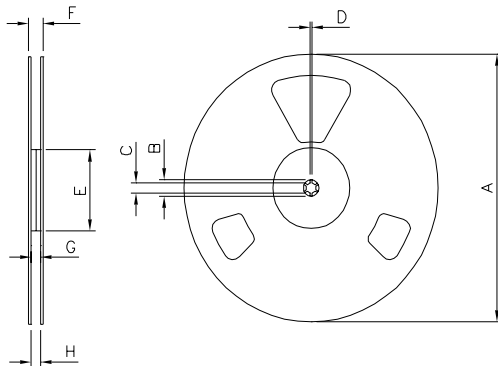

NOTE: Controlling dimensions in mm  
 Std reel quantity is 4800 parts. (ordered as IRF8302MTRPBF). For 1000 parts on 7" reel, order IRF8302MTR1PBF

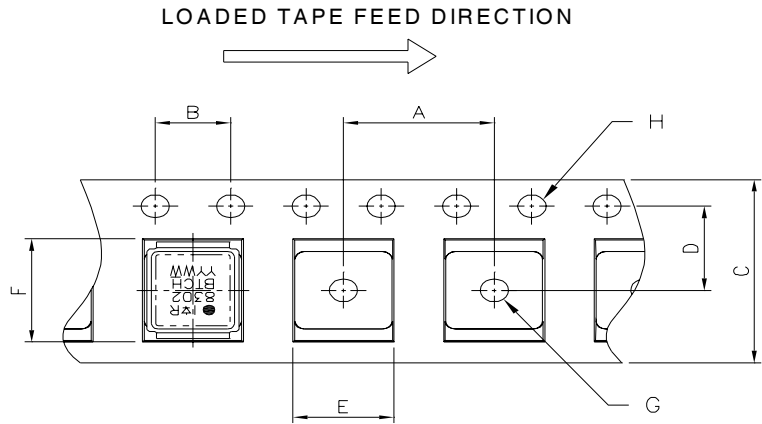

REEL DIMENSIONS				
STANDARD OPTION (QTY 4800)				
CODE	METRIC		IMPERIAL	
	MIN	MAX	MIN	MAX
A	330	N.C	12.992	N.C
B	20.2	N.C	0.795	N.C
C	12.8	13.2	0.504	0.520
D	1.5	N.C	0.059	N.C
E	100.0	N.C	3.937	N.C
F	N.C	18.4	N.C	0.724
G	12.4	14.4	0.488	0.567
H	11.9	15.4	0.469	0.606

NOTE: CONTROLLING DIMENSIONS IN MM

CODE	METRIC		IMPERIAL	
	MIN	MAX	MIN	MAX
A	7.90	8.10	0.311	0.319
B	3.90	4.10	0.154	0.161
C	11.90	12.30	0.469	0.484
D	5.45	5.55	0.215	0.219
E	5.10	5.30	0.201	0.209
F	6.50	6.70	0.256	0.264
G	1.50	N.C	0.059	N.C
H	1.50	1.60	0.059	0.063

Revision History

Date	Comments
2/17/2014	<ul style="list-style-type: none"> <li>Added the ordering information table, on page 1.</li> <li>Updated data sheet with new IR corporate template.</li> </ul>

## **IMPORTANT NOTICE**

The information given in this document shall in no event be regarded as a guarantee of conditions or characteristics ("Beschaffheitsgarantie").

With respect to any examples, hints or any typical values stated herein and/or any information regarding the application of the product, Infineon Technologies hereby disclaims any and all warranties and liabilities of any kind, including without limitation warranties of non-infringement of intellectual property rights of any third party.

In addition, any information given in this document is subject to customer's compliance with its obligations stated in this document and any applicable legal requirements, norms and standards concerning customer's products and any use of the product of Infineon Technologies in customer's applications.

The data contained in this document is exclusively intended for technically trained staff. It is the responsibility of customer's technical departments to evaluate the suitability of the product for the intended application and the completeness of the product information given in this document with respect to such application.

For further information on the product, technology, delivery terms and conditions and prices please contact your nearest Infineon Technologies office ([www.infineon.com](http://www.infineon.com)).

## **WARNINGS**

Due to technical requirements products may contain dangerous substances. For information on the types in question please contact your nearest Infineon Technologies office.

Except as otherwise explicitly approved by Infineon Technologies in a written document signed by authorized representatives of Infineon Technologies, Infineon Technologies' products may not be used in any applications where a failure of the product or any consequences of the use thereof can reasonably be expected to result in personal injury.

# Mouser Electronics

Authorized Distributor

Click to View Pricing, Inventory, Delivery & Lifecycle Information:

[Infineon:](#)

[IRF8302MTRPBF](#)