



ProLight PK2E-2LxE-B2xx
Technical Datasheet
Version: 2.3

ProLight Opto ® PK2E Series

Features

- 100% foot print compatible with Cree XP-C / XP-E / XP-G
- Best thermal material solution of the world
- Best Moisture Sensitivity:JEDEC Level 1
- RoHS compliant

Main Applications

- Entertainment Lighting
- Commercial Lighting
- Indoor Lighting
- Outdoor Lighting

Introduction

- ProLight Phenix 3535, is one of the smallest high power LED footprint available by ProLight Opto, has offered extended solid-state lighting design possibilities. ProLight Phenix 3535 is designed with ProLight own Patents and using copper leadframe, the best thermal material of the world.
- Phenix 3535 qualifies as the JEDEC Level 1 MSL sensitivity level and suitable for SMD process, Pb_free reflow soldering capability, and full compliance with EU Reduction of Hazardous Substances (RoHS) legislation.

Emitter Mechanical Dimensions

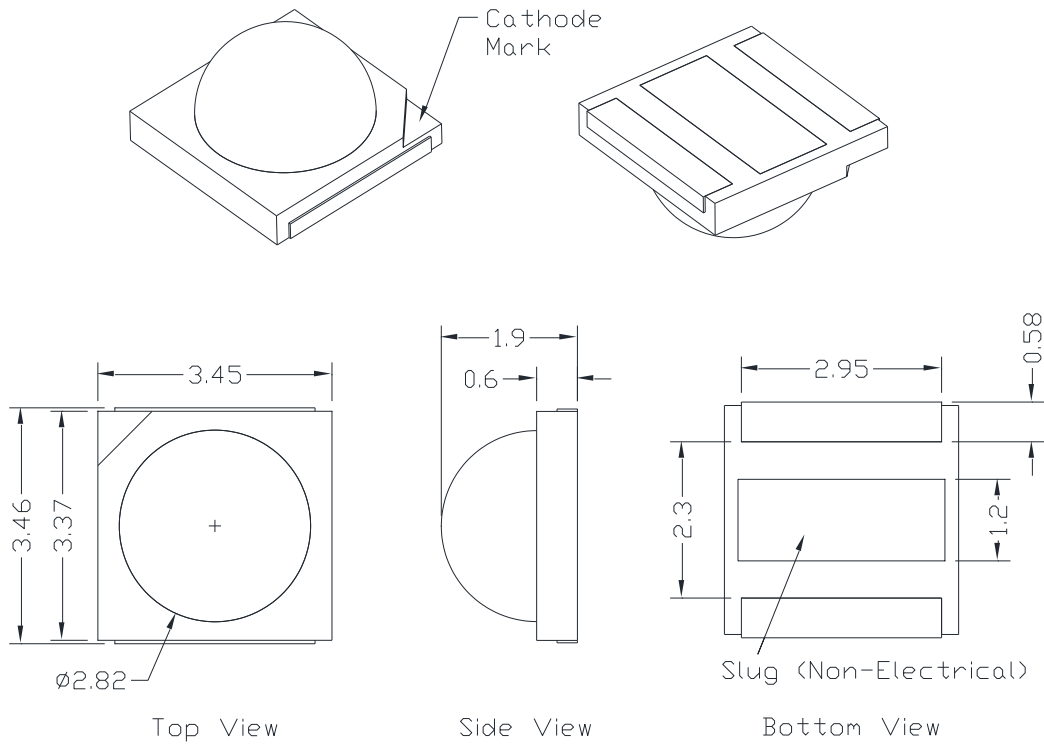

Notes:

1. The cathode side of the device is denoted by the chamfer on the part body.
2. Electrical insulation between the case and the board is required. Do not electrically connect either the anode or cathode to the slug.
3. Drawing not to scale.
4. All dimensions are in millimeters.
5. Unless otherwise indicated, tolerances are ± 0.10 mm.
6. Please do not solder the emitter by manual hand soldering, otherwise it will damage the emitter.
7. **Please do not use a force of over 0.3kgf impact or pressure on the lens of the LED, otherwise it will cause a catastrophic failure.**

*The appearance and specifications of the product may be modified for improvement without notice.

Flux Characteristics, $T_j = 25^\circ\text{C}$

Color	Part Number Emitter	Luminous Flux Φ_v (lm)				CRI Minimum
		@350mA		Refer @700mA		
		Minimum	Typical	Minimum	Typical	
White	PK2E-2LWE-B2R7	145	165	243	276	70
Neutral White	PK2E-2LNE-B2R7	145	159	243	266	70
Warm White	PK2E-2LVE-B2R7	130	145	217	242	70
White	PK2E-2LWE-B2R8	130	145	217	242	80
Neutral White	PK2E-2LNE-B2R8	130	143	217	239	80
Warm White	PK2E-2LVE-B2R8	120	137	201	229	80

- ProLight maintains a tolerance of $\pm 7\%$ on flux and power measurements.
- ProLight maintains a tolerance of ± 2 on CRI measurements.
- Please do not drive at rated current more than 1 second without proper heat sink.

Electrical Characteristics, $T_j = 25^\circ\text{C}$

Color	Forward Voltage V_F (V) @350mA			Forward Voltage V_F (V) Refer @700mA	Thermal Resistance Junction to Slug ($^\circ\text{C}/\text{W}$)
	Min.	Typ.	Max.	Typ.	
White	2.8	3.1	3.2	3.5	6
Neutral White	2.8	3.1	3.2	3.5	6
Warm White	2.8	3.1	3.2	3.5	6

- ProLight maintains a tolerance of $\pm 0.1\text{V}$ for Voltage measurements.

Optical Characteristics at 350mA, $T_j = 25^\circ\text{C}$

Radiation Pattern	Color	Color Temperature CCT			Total included Angle (degrees)	Viewing Angle (degrees)
		Min.	Typ.	Max.	$\theta_{0.90v}$	$2\theta_{1/2}$
Lambertian	White	5000 K	6000 K	7000 K	160	130
	Neutral White	3800 K	4400 K	5000 K	160	130
	Warm White	2700 K	2975 K	3250 K	160	130

- ProLight maintains a tolerance of $\pm 5\%$ for CCT measurements.

Absolute Maximum Ratings

Parameter	White/Neutral White/Warm White
DC Forward Current (mA)	700
Peak Pulsed Forward Current (mA)	800 (less than 1/10 duty cycle@1KHz)
ESD Sensitivity (HBM per MIL-STD-883E Method 3015.7)	> ±500V
LED Junction Temperature	120°C
Operating Board Temperature at Maximum DC Forward Current	-40°C - 90°C
Storage Temperature	-40°C - 120°C
Soldering Temperature	JEDEC 020c 260°C
Allowable Reflow Cycles	3
Reverse Voltage	Not designed to be driven in reverse bias

Photometric Luminous Flux Bin Structure at 350mA

Color	Bin Code	Minimum Photometric Flux (lm)	Maximum Photometric Flux (lm)	Available Color Bins
PK2E-2LWE-B2R7	W2	145	160	All
	X1	160	175	All
	X2	175	190	[1]
PK2E-2LNE-B2R7	W2	145	160	All
	X1	160	175	All
	X2	175	190	[1]
PK2E-2LVE-B2R7	W1	130	145	All
	W2	145	160	All
	X1	160	175	[1]
PK2E-2LWE-B2R8	W1	130	145	All
	W2	145	160	All
	X1	160	175	All
	X2	175	190	[1]
PK2E-2LNE-B2R8	W1	130	145	All
	W2	145	160	All
	X1	160	175	[1]
PK2E-2LVE-B2R8	V2	120	130	All
	W1	130	145	All
	W2	145	160	[1]

- ProLight maintains a tolerance of $\pm 7\%$ on flux and power measurements.
- The flux bin of the product may be modified for improvement without notice.
- [1] The rest of color bins are not 100% ready for order currently. Please ask for quote and order Possibility.

Forward Voltage Bin Structure at 350mA

Color	Bin Code	Minimum Voltage (V)	Maximum Voltage (V)
White	A	2.8	3.0
	B	3.0	3.2
Neutral White	A	2.8	3.0
	B	3.0	3.2
Warm White	A	2.8	3.0
	B	3.0	3.2

- ProLight maintains a tolerance of $\pm 0.1V$ for Voltage measurements.

Note: Although several bins are outlined, product availability in a particular bin varies by production run and by product performance. Not all bins are available in all colors.

Color Bin

White Binning Structure Graphical Representation

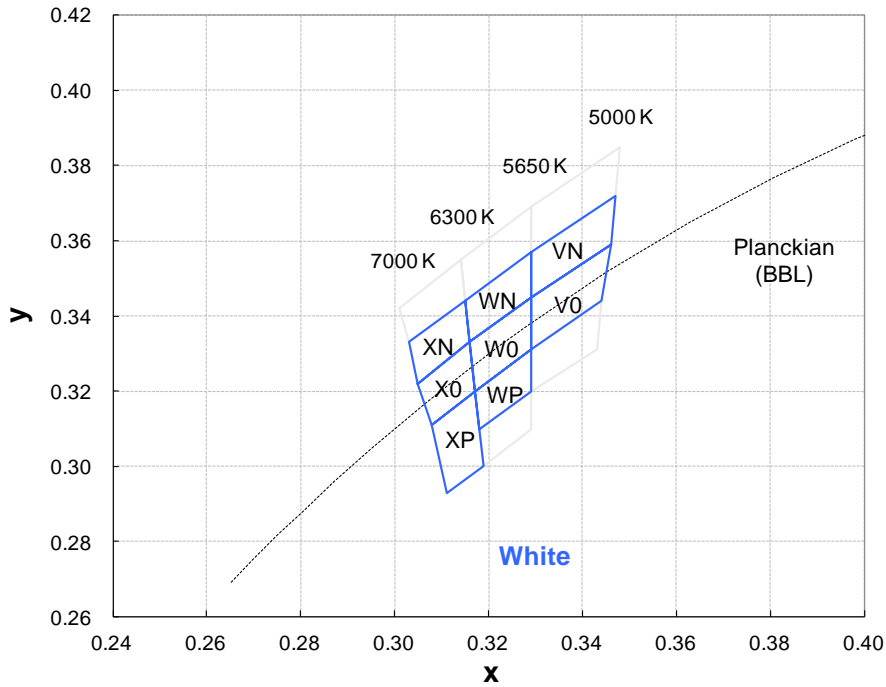

White Bin Structure

Bin Code	x	y	Typ. CCT (K)	Bin Code	x	y	Typ. CCT (K)
V0	0.329	0.331	5320	WP	0.329	0.331	5970
	0.329	0.345			0.329	0.320	
	0.346	0.359			0.318	0.310	
	0.344	0.344			0.317	0.320	
VN	0.329	0.345	5320	X0	0.308	0.311	6650
	0.329	0.357			0.305	0.322	
	0.347	0.372			0.316	0.333	
	0.346	0.359			0.317	0.320	
W0	0.329	0.345	5970	XN	0.305	0.322	6650
	0.329	0.331			0.303	0.333	
	0.317	0.320			0.315	0.344	
	0.316	0.333			0.316	0.333	
WN	0.329	0.345	5970	XP	0.308	0.311	6650
	0.316	0.333			0.317	0.320	
	0.315	0.344			0.319	0.300	
	0.329	0.357			0.311	0.293	

- Tolerance on each color bin (x , y) is ± 0.005

Color Bin

Neutral White Binning Structure Graphical Representation

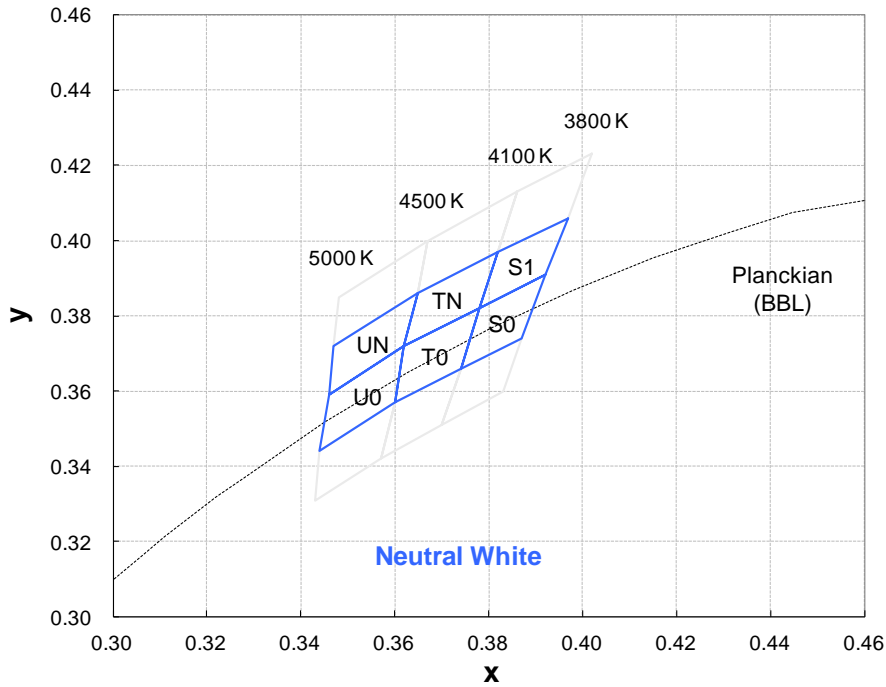

Neutral White Bin Structure

Bin Code	x	y	Typ. CCT (K)	Bin Code	x	y	Typ. CCT (K)
S1	0.3970	0.4060	3950	T0	0.3780	0.3820	4250
	0.3920	0.3910			0.3740	0.3660	
	0.3780	0.3820			0.3600	0.3570	
	0.3820	0.3970			0.3620	0.3720	
S0	0.3920	0.3910	3950	UN	0.3650	0.3860	4750
	0.3870	0.3740			0.3620	0.3720	
	0.3740	0.3660			0.3460	0.3590	
	0.3780	0.3820			0.3470	0.3720	
TN	0.3820	0.3970	4250	U0	0.3620	0.3720	4750
	0.3780	0.3820			0.3600	0.3570	
	0.3620	0.3720			0.3440	0.3440	
	0.3650	0.3860			0.3460	0.3590	

- Tolerance on each color bin (x , y) is ± 0.005

Color Bin

Warm White Binning Structure Graphical Representation

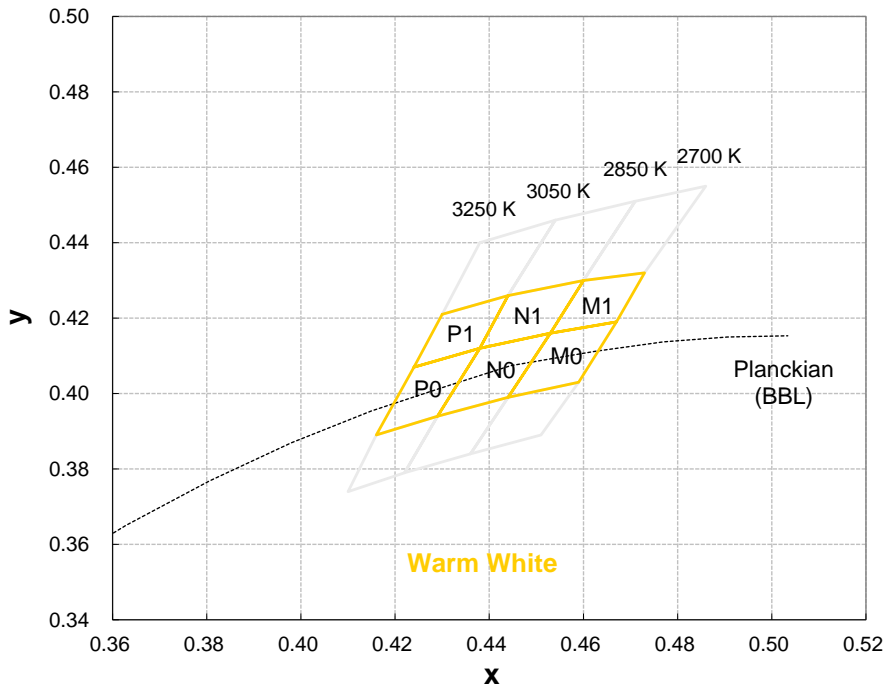

Warm White Bin Structure

Bin Code	x	y	Typ. CCT (K)	Bin Code	x	y	Typ. CCT (K)
M1	0.4600	0.4300	2770	N0	0.4380	0.4120	2950
	0.4530	0.4160			0.4290	0.3940	
	0.4670	0.4190			0.4440	0.3990	
	0.4730	0.4320			0.4530	0.4160	
M0	0.4530	0.4160	2770	P1	0.4300	0.4210	3150
	0.4440	0.3990			0.4240	0.4070	
	0.4590	0.4030			0.4380	0.4120	
	0.4670	0.4190			0.4440	0.4260	
N1	0.4440	0.4260	2950	P0	0.4240	0.4070	3150
	0.4380	0.4120			0.4160	0.3890	
	0.4530	0.4160			0.4290	0.3940	
	0.4600	0.4300			0.4380	0.4120	

- Tolerance on each color bin (x , y) is ± 0.005

Color Spectrum, $T_j = 25^\circ\text{C}$

1. PK2E-2LWE-B2R7 、 PK2E-2LWE-B2R8

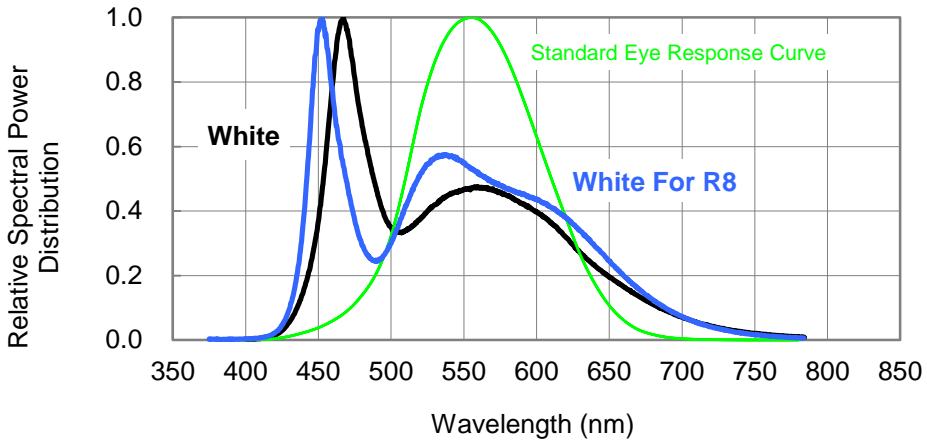

2. PK2E-2LNE-B2R7 、 PK2E-2LNE-B2R8

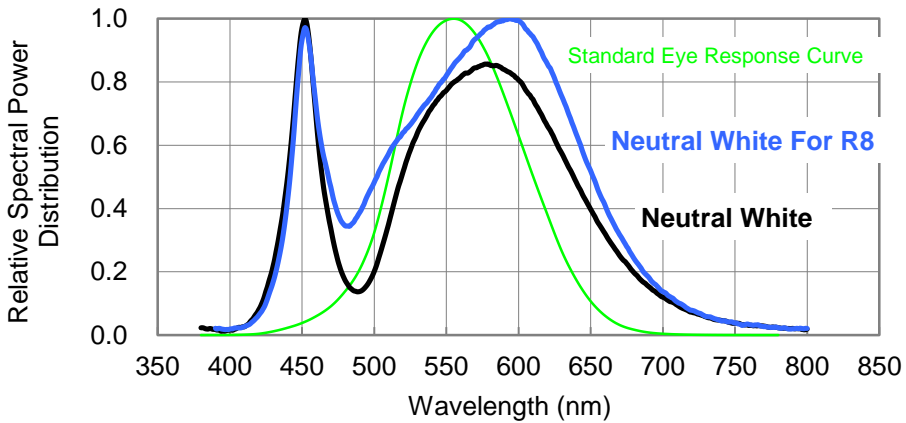

3. PK2E-2LVE-B2R7 、 PK2E-2LVE-B2R8

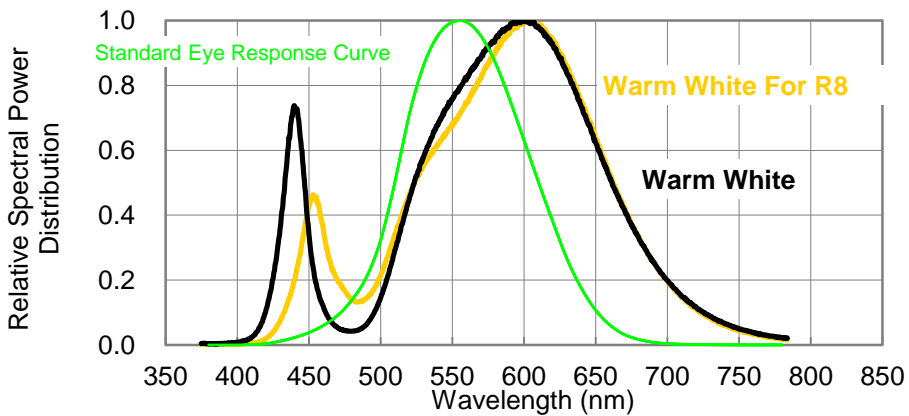

Light Output Characteristics

Relative Light Output vs. Junction Temperature at 700mA

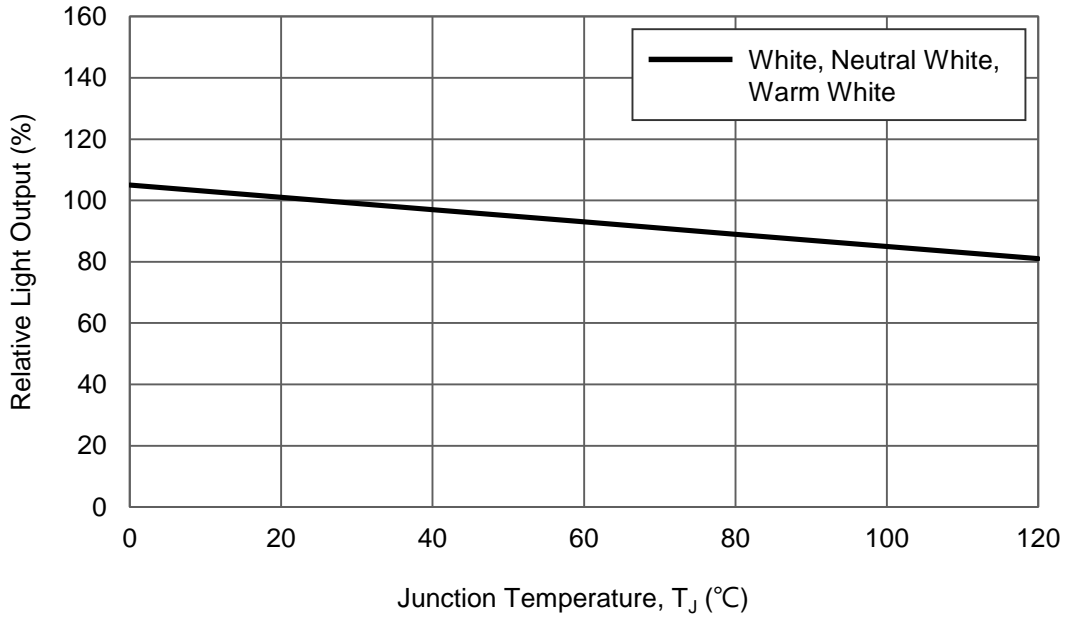

Forward Current Characteristics, $T_J = 25^\circ\text{C}$

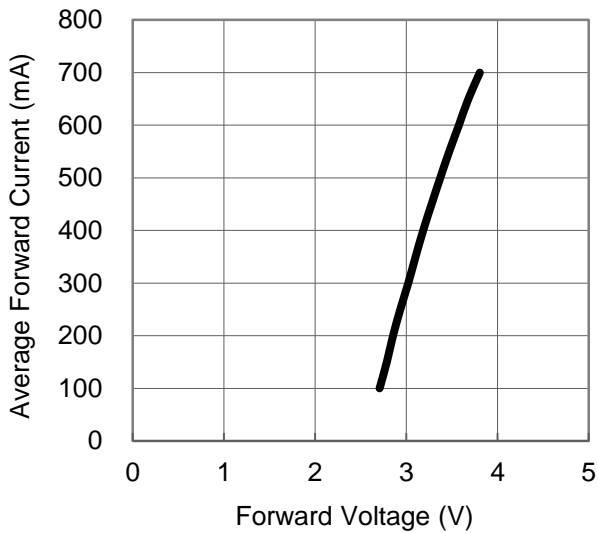

Fig 1. Forward Current vs. Forward Voltage for White, Neutral White, Warm White.

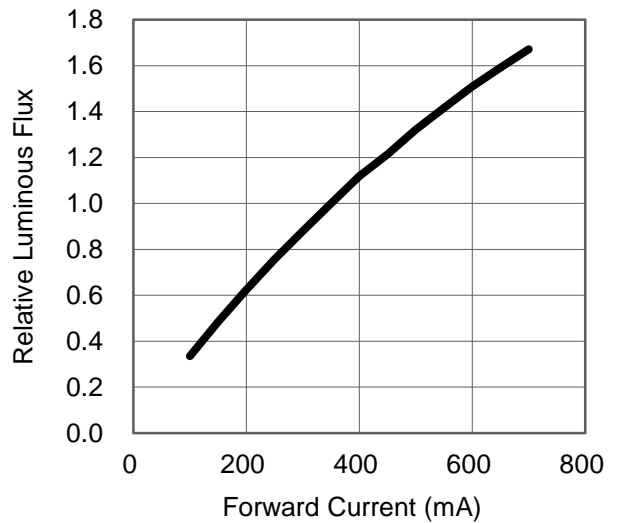
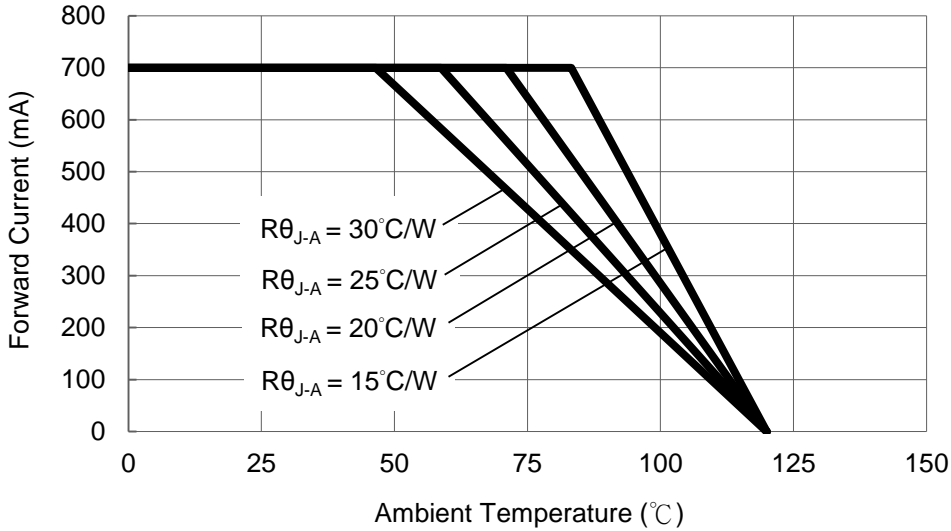

Fig 2. Relative Luminous Flux vs. Forward Current for White, Neutral White, Warm White at $T_J=25$ maintained.

Ambient Temperature vs. Maximum Forward Current

1. White, Neutral White, Warm White ($T_{JMAX} = 120^{\circ}C$)



Typical Representative Spatial Radiation Pattern

Lambertian Radiation Pattern

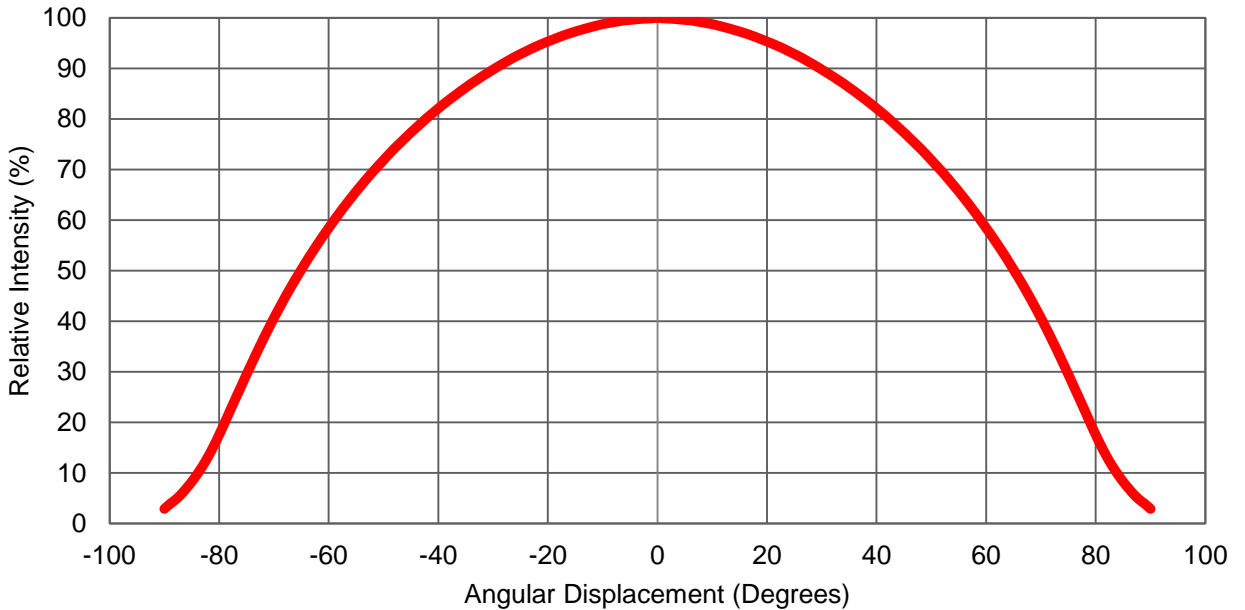

Moisture Sensitivity Level - JEDEC Level 1

Level	Floor Life		Soak Requirements			
			Standard		Accelerated Environment	
	Time	Conditions	Time (hours)	Conditions	Time (hours)	Conditions
1	Unlimited	≤30°C / 85% RH	168 +5/-0	85°C / 85% RH	NA	NA

- The standard soak time includes a default value of 24 hours for semiconductor manufacture's exposure time (MET) between bake and bag and includes the maximum time allowed out of the bag at the distributor's facility.
- Table below presents the moisture sensitivity level definitions per IPC/JEDEC's J-STD-020C.

Level	Floor Life		Soak Requirements			
			Standard		Accelerated Environment	
	Time	Conditions	Time (hours)	Conditions	Time (hours)	Conditions
1	Unlimited	≤30°C / 85% RH	168 +5/-0	85°C / 85% RH	NA	NA
2	1 year	≤30°C / 60% RH	168 +5/-0	85°C / 60% RH	NA	NA
2a	4 weeks	≤30°C / 60% RH	696 +5/-0	30°C / 60% RH	120 +1/-0	60°C / 60% RH
3	168 hours	≤30°C / 60% RH	192 +5/-0	30°C / 60% RH	40 +1/-0	60°C / 60% RH
4	72 hours	≤30°C / 60% RH	96 +2/-0	30°C / 60% RH	20 +0.5/-0	60°C / 60% RH
5	48 hours	≤30°C / 60% RH	72 +2/-0	30°C / 60% RH	15 +0.5/-0	60°C / 60% RH
5a	24 hours	≤30°C / 60% RH	48 +2/-0	30°C / 60% RH	10 +0.5/-0	60°C / 60% RH
6	Time on Label (TOL)	≤30°C / 60% RH	Time on Label (TOL)	30°C / 60% RH	NA	NA

Qualification Reliability Testing

Stress Test	Stress Conditions	Stress Duration	Failure Criteria
Room Temperature Operating Life (RTOL)	25°C, $I_F = \text{max DC}$ (Note 1)	1000 hours	Note 2
Wet High Temperature Operating Life (WHTOL)	85°C/60%RH, $I_F = \text{max DC}$ (Note 1)	1000 hours	Note 2
Wet High Temperature Storage Life (WHTSL)	85°C/85%RH, non-operating	1000 hours	Note 2
High Temperature Storage Life (HTSL)	110°C, non-operating	1000 hours	Note 2
Low Temperature Storage Life (LTSL)	-40°C, non-operating	1000 hours	Note 2
Non-operating Temperature Cycle (TMCL)	-40°C to 120°C, 30 min. dwell, <5 min. transfer	200 cycles	Note 2
Mechanical Shock	1500 G, 0.5 msec. pulse, 5 shocks each 6 axis		Note 3
Natural Drop	On concrete from 1.2 m, 3X		Note 3
Variable Vibration Frequency	10-2000-10 Hz, log or linear sweep rate, 20 G about 1 min., 1.5 mm, 3X/axis		Note 3
Solder Heat Resistance (SHR)	260°C ± 5°C, 10 sec.		Note 3
Solderability	Steam age for 16 hrs., then solder dip at 260°C for 5 sec.		Solder coverage on lead

Notes:

1. Depending on the maximum derating curve.
2. Criteria for judging failure

Item	Test Condition	Criteria for Judgement	
		Min.	Max.
Forward Voltage (V_F)	$I_F = \text{max DC}$	--	Initial Level x 1.1
Luminous Flux or Radiometric Power (Φ_V)	$I_F = \text{max DC}$	Initial Level x 0.7	--
Reverse Current (I_R)	$V_R = 5V$	--	50 μA

* The test is performed after the LED is cooled down to the room temperature.

3. A failure is an LED that is open or shorted.

Recommended Solder Pad Design

Standard Emitter

TYPE A.

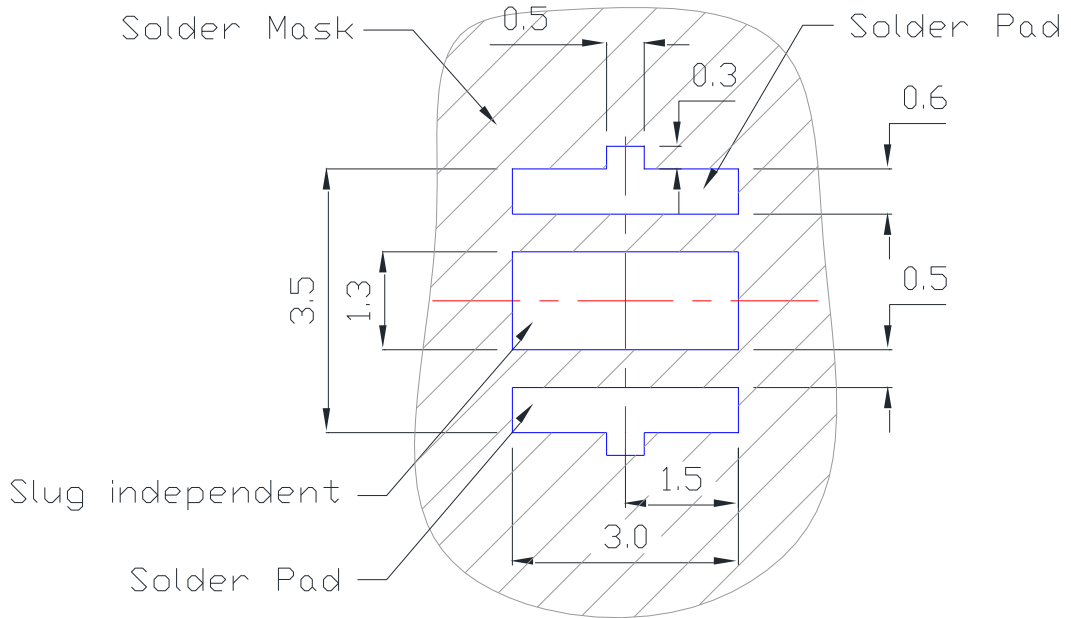

TYPE B.

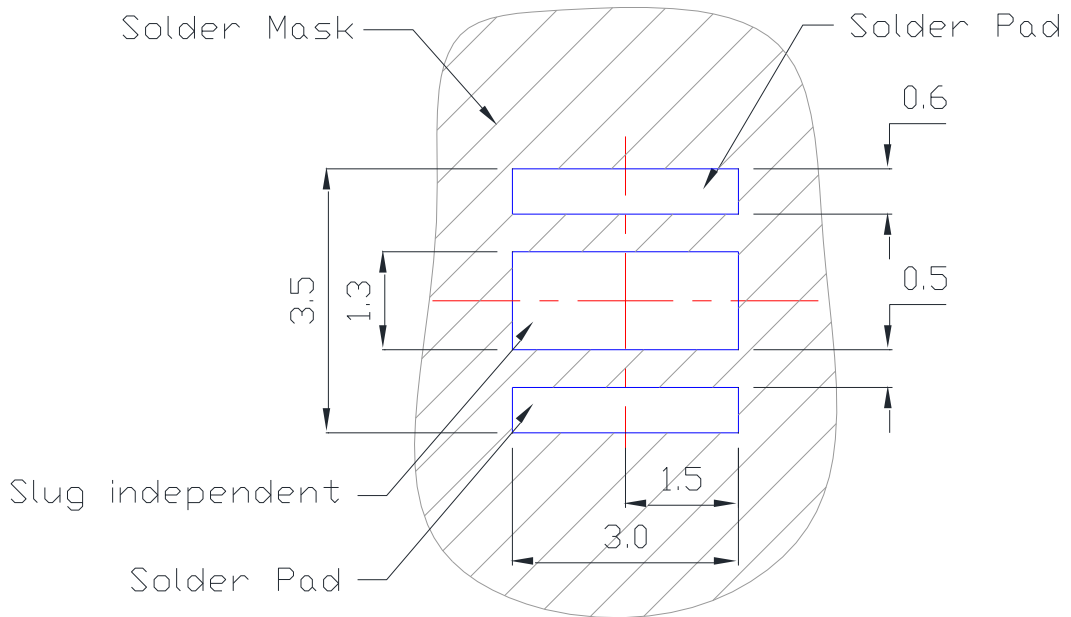

- All dimensions are in millimeters.
- Electrical isolation is required between Slug and Solder Pad.

Reflow Soldering Condition

Profile Feature	Sn-Pb Eutectic Assembly	Pb-Free Assembly
Average Ramp-Up Rate (T_{Smax} to T_p)	3°C / second max.	3°C / second max.
Preheat <ul style="list-style-type: none"> – Temperature Min (T_{Smin}) – Temperature Max (T_{Smax}) – Time (t_{Smin} to t_{Smax}) 	100°C 150°C 60-120 seconds	150°C 200°C 60-180 seconds
Time maintained above: <ul style="list-style-type: none"> – Temperature (T_L) – Time (t_L) 	183°C 60-150 seconds	217°C 60-150 seconds
Peak/Classification Temperature (T_p)	240°C	260°C
Time Within 5°C of Actual Peak Temperature (t_p)	10-30 seconds	20-40 seconds
Ramp-Down Rate	6°C/second max.	6°C/second max.
Time 25°C to Peak Temperature	6 minutes max.	8 minutes max.

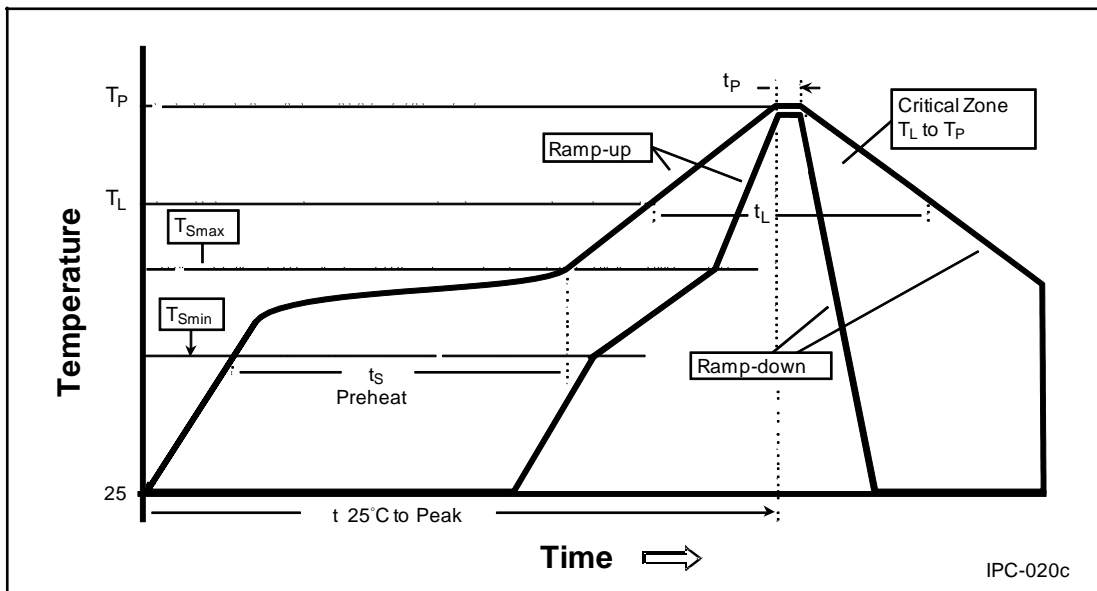

- We recommend using the M705-S101-S4 solder paste from SMIC (Senju Metal Industry Co., Ltd.) for lead-free soldering.
- Do not use solder pastes with post reflow flux residue > 47%. (58Bi-42Sn eutectic alloy, etc) This kind of solder pastes may cause a reliability problem to LED.
- All temperatures refer to topside of the package, measured on the package body surface.
- Repairing should not be done after the LEDs have been soldered. When repairing is unavoidable, a double-head soldering iron should be used. It should be confirmed beforehand whether the characteristics of the LEDs will or will not be damaged by repairing.
- Reflow soldering should not be done more than three times.
- When soldering, do not put stress on the LEDs during heating.
- After soldering, do not warp the circuit board.

Emitter Reel Packaging

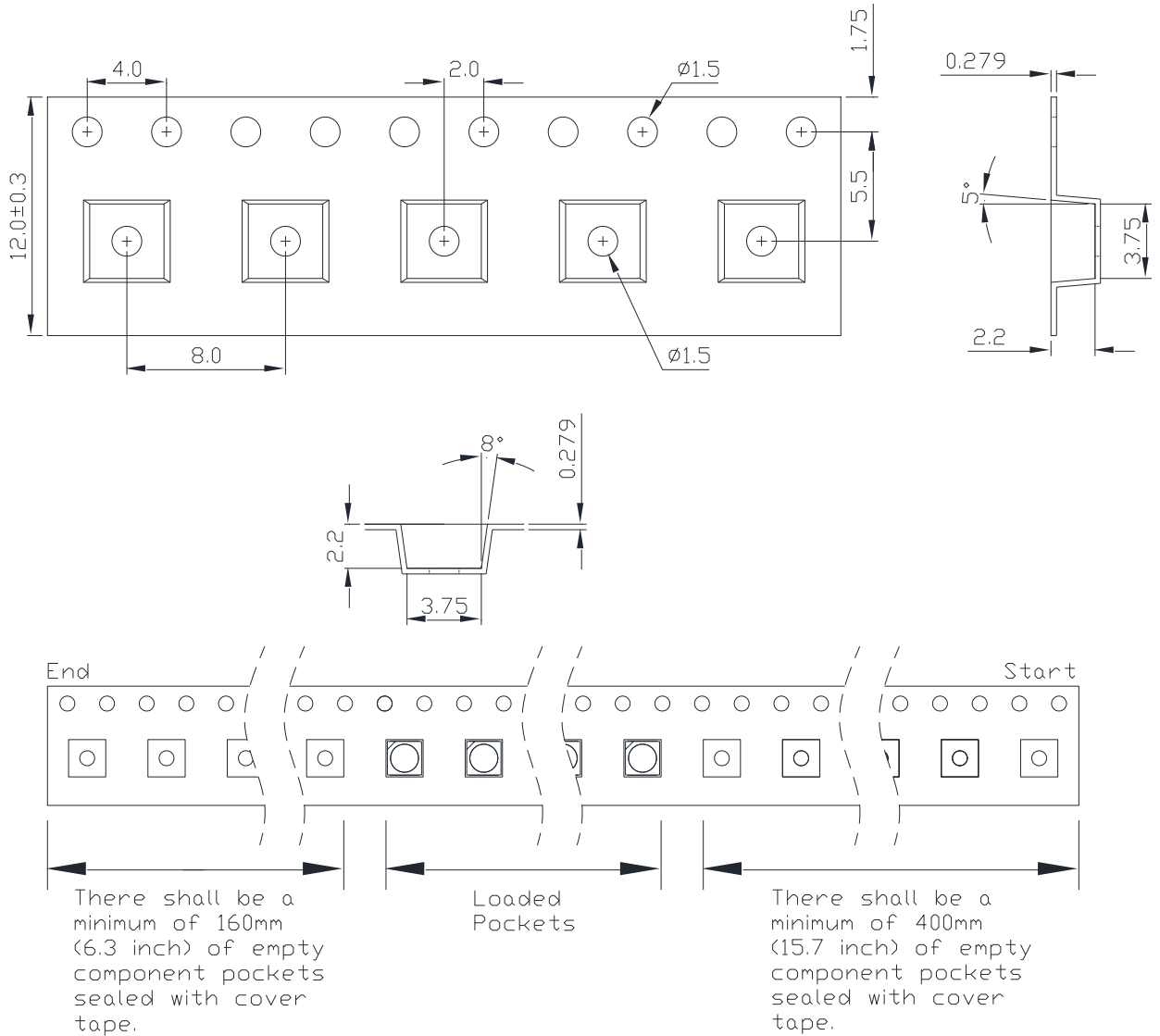

Notes:

1. Drawing not to scale.
2. All dimensions are in millimeters.
3. Unless otherwise indicated, tolerances are ± 0.10 mm.

Emitter Reel Packaging

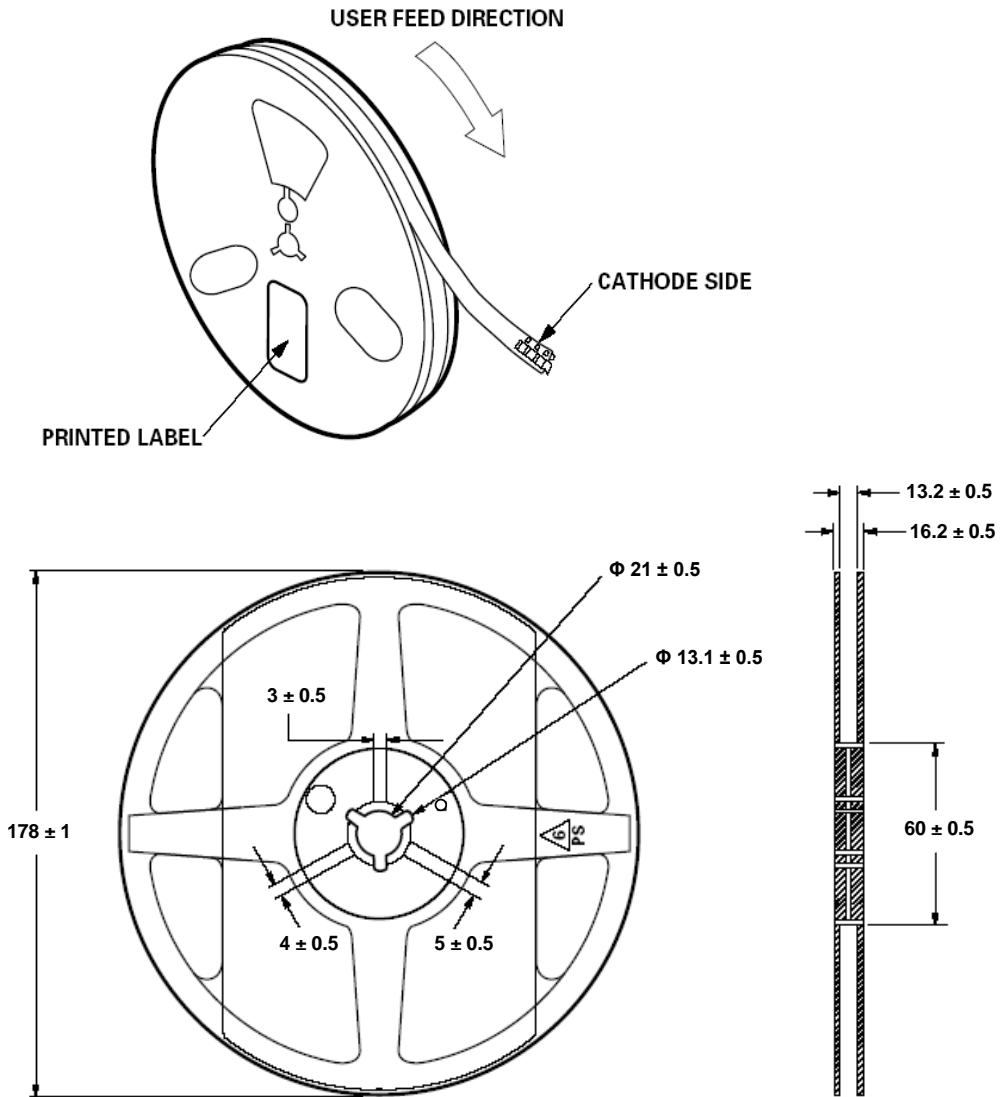

Notes:

1. Empty component pockets sealed with top cover tape.
2. 250, 500 and 1000 pieces per reel.
3. Drawing not to scale.
4. All dimensions are in millimeters.

Precaution for Use

- Storage
Please do not open the moisture barrier bag (MBB) more than one week. This may cause the leads of LED discoloration. We recommend storing ProLight's LEDs in a dry box after opening the MBB. The recommended storage conditions are temperature 5 to 30 °C and humidity less than 40% RH. It is also recommended to return the LEDs to the MBB and to reseal the MBB.
- The slug is not electrically neutral. Therefore, we recommend to isolate the heat sink.
- **We recommend using the M705-S101-S4 solder paste from SMIC (Senju Metal Industry Co., Ltd.) for lead-free soldering.**
- **Do not use solder pastes with post reflow flux residue > 47%. (58Bi-42Sn eutectic alloy, etc) This kind of solder pastes may cause a reliability problem to LED.**
- **Electric Static Discharge (ESD) Protection**
The LEDs are STATIC SENSITIVE device. ESD protection or surge voltages shall be considered and taken care in the initial design stage, and whole production process. The following protection is recommended:
(1) A wrist band or an anti-electrostatic glove shall be used when handling the LEDs.
(2) All devices, equipment and machinery must be properly grounded.
- Any mechanical force or any excess vibration shall not be accepted to apply during cooling process to normal temperature after soldering.
- Please avoid rapid cooling after soldering.
- Components should not be mounted on warped direction of PCB.
- Repairing should not be done after the LEDs have been soldered. When repairing is unavoidable, a heat plate should be used. It should be confirmed beforehand whether the characteristics of the LEDs will or will not be damaged by repairing.
- This device should not be used in any type of fluid such as water, oil, organic solvent and etc. When cleaning is required, isopropyl alcohol should be used.
- When the LEDs are illuminating, operating current should be decided after considering the package maximum temperature.
- The appearance, specifications and flux bin of the product may be modified for improvement without notice. Please refer to the below website for the latest datasheets.
<http://www.prolightopto.com/>

Handling of Silicone Lens LEDs

Notes for handling of silicone lens LEDs

- Please do not use a force of over 0.3kgf impact or pressure on the silicone lens, otherwise it will cause a catastrophic failure.
- The LEDs should only be picked up by making contact with the sides of the LED body.
- Avoid touching the silicone lens especially by sharp tools such as Tweezers.
- Avoid leaving fingerprints on the silicone lens.
- Please store the LEDs away from dusty areas or seal the product against dust.
- When populating boards in SMT production, there are basically no restrictions regarding the form of the pick and place nozzle, except that mechanical pressure on the silicone lens must be prevented.
- Please do not mold over the silicone lens with another resin. (epoxy, urethane, etc)

