



Наличие и актуальные цены на

RSP-2000-24

<https://www.mean-well.ru/store/RSP-2000-24/>



2000W Power Supply with Single Output

RSP-2000 series

Dimension

| L | * | W | * | H |
|------|---|-----|---|---------------|
| 295 | * | 127 | * | 41 (1U) mm |
| 11.6 | * | 5 | * | 1.61(1U) inch |



Features

- Universal AC input / Full range
- Built-in active PFC function
- High efficiency up to 92%
- Forced air cooling by built-in DC fan
- Output voltage programmable
- Active current sharing up to 8000W (3+1)
- Built-in remote ON-OFF control / remote sense / auxiliary power / DC OK signal / OTP alarm signal
- Protections: Short circuit / Overload / Over voltage / Over temperature
- Optional conformal coating
- 5 years warranty

Applications

- Factory control or automation apparatus
- Test and measurement instrument
- Laser related machine
- Burn-in facility
- Digital broadcasting
- RF application

GTIN CODE

MW Search: <https://www.meanwell.com/serviceGTIN.aspx>

Description

RSP-2000 is a 2KW single output enclosed type AC/DC power supply with 1U low profile. This series operates for 90~264VAC input voltage and offers the models with the DC output mostly demanded from the industry. Each model is cooled by the built-in fan with fan speed control, working for the temperature up to 70°C. Moreover, RSP-2000 provides vast design flexibility by equipping various built-in functions such as the output programming, active current sharing, remote ON-OFF control, auxiliary power, etc.

Model Encoding / Order Information

RSP - 2000 - 48

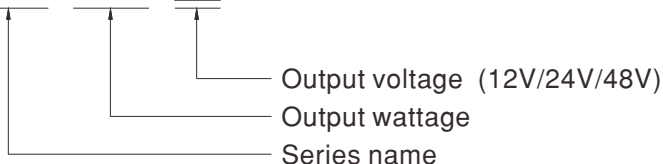

SPECIFICATION

| MODEL | | RSP-2000-12 | RSP-2000-24 | RSP-2000-48 | |
|--------------------------------|--|---|--|-----------------------|--|
| OUTPUT | DC VOLTAGE | 12V | 24V | 48V | |
| | RATED CURRENT | 100A | 80A | 42A | |
| | CURRENT RANGE | 0 ~ 100A | 0 ~ 80A | 0 ~ 42A | |
| | RATED POWER | 1200W | 1920W | 2016W | |
| | RIPPLE & NOISE (max.) Note.2 | 150mVp-p | 200mVp-p | 300mVp-p | |
| | VOLTAGE ADJ. RANGE | 10.5 ~ 14V | 21 ~ 28V | 42 ~ 56V | |
| | VOLTAGE TOLERANCE Note.3 | ±2.0% | ±1.0% | ±1.0% | |
| | LINE REGULATION | ±1.0% | ±0.5% | ±0.5% | |
| | LOAD REGULATION | ±1.0% | ±0.5% | ±0.5% | |
| | SETUP, RISE TIME | 1500ms, 60ms/230VAC at full load | | | |
| HOLD UP TIME (Typ.) | 16ms/230VAC at 75% load | | 10ms/230VAC at full load | | |
| INPUT | VOLTAGE RANGE Note.4,5 | 90 ~ 264VAC 250 ~ 320VDC | | | |
| | FREQUENCY RANGE | 47 ~ 63Hz | | | |
| | POWER FACTOR (Typ.) | 0.97/230VAC at full load | | | |
| | EFFICIENCY (Typ.) | 87% | 90.5% | 92% | |
| | AC CURRENT (Typ.) Note.4 | 13A/115VAC 7A/230VAC | 16A/115VAC 10A/230VAC | 16A/115VAC 10A/230VAC | |
| | INRUSH CURRENT (Typ.) | COLD START 50A | | | |
| | LEAKAGE CURRENT | <2mA / 240VAC | | | |
| PROTECTION | OVERLOAD | 105 ~ 125% rated output power Protection type : Constant current limiting, unit will shut down o/p voltage after 5 sec. re-power on to recover | | | |
| | OVER VOLTAGE | 14.7 ~ 17.5V | 29.5 ~ 35V | 57.6 ~ 67.2V | |
| | OVER TEMPERATURE | Shut down o/p voltage, recovers automatically after temperature goes down | | | |
| FUNCTION | OUTPUT VOLTAGE PROGRAMMABLE(PV) | Adjustment of output voltage is allowable to 40 ~ 115% of nominal output voltage. Please refer to the Function Manual. | | | |
| | CURRENT SHARING | Up to 8000W or (3+1) units. Please refer to the Function Manual. | | | |
| | AUXILIARY POWER | 5V @ 0.3A, 12V @ 0.8A | | | |
| | REMOTE ON-OFF CONTROL | By electrical signal or dry contact Power ON:open Power OFF:short. Please refer to the Function Manual. | | | |
| | REMOTE SENSE | Compensate voltage drop on the load wiring up to 0.5V. Please refer to the Function Manual. | | | |
| | DC OK SIGNAL | The isolated TTL signal out. Please refer to the Function Manual. | | | |
| ENVIRONMENT | WORKING TEMP. | -35 ~ +70°C (Refer to "Derating Curve") | | | |
| | WORKING HUMIDITY | 20 ~ 90% RH non-condensing | | | |
| | STORAGE TEMP., HUMIDITY | -40 ~ +85°C, 10 ~ 95% RH non-condensing | | | |
| | TEMP. COEFFICIENT | ±0.03%/°C (0 ~ 50°C) | | | |
| | VIBRATION | 10 ~ 500Hz, 2G 10min./1cycle, 60min. each along X, Y, Z axes | | | |
| SAFETY & EMC (Note 6) | SAFETY STANDARDS | UL62368-1, CSA C22.2 No. 62368-1, TUV BS EN/EN62368-1, BSMI CNS15598-1, AS/NZS62368.1, BIS IS13252(Part1): 2010/IEC 60950-1:2005 (except 48V), EAC TP TC 004 approved | | | |
| | WITHSTAND VOLTAGE | I/P-O/P:3KVAC I/P-FG:2KVAC O/P-FG:0.5KVAC | | | |
| | ISOLATION RESISTANCE | I/P-O/P, I/P-FG, O/P-FG:100M Ohms / 500VDC / 25°C / 70% RH | | | |
| | EMC EMISSION | Parameter | Standard | Test Level / Note | |
| | | Conducted | BS EN/EN55032 (CISPR32), CNS15936 | Class B | |
| | | Radiated | BS EN/EN55032 (CISPR32), CNS15936 | Class A | |
| | | Harmonic Current | BS EN/EN61000-3-2 | ----- | |
| | Voltage Flicker | BS EN/EN61000-3-3 | ----- | | |
| | EMC IMMUNITY | BS EN/EN55035, BS EN/EN61000-6-2, BSMI CNS13438 | | | |
| | | Parameter | Standard | Test Level / Note | |
| ESD | | BS EN/EN61000-4-2 | Level 3, 8KV air ; Level 2, 4KV contact | | |
| Radiated | | BS EN/EN61000-4-3 | Level 3 | | |
| EFT / Burst | | BS EN/EN61000-4-4 | Level 3 | | |
| Surge | | BS EN/EN61000-4-5 | Level 4, 4KV/Line-Earth ; Level 3, 2KV/Line-Line | | |
| Conducted | | BS EN/EN61000-4-6 | Level 3 | | |
| Magnetic Field | | BS EN/EN61000-4-8 | Level 4 | | |
| Voltage Dips and Interruptions | BS EN/EN61000-4-11 | >95% dip 0.5 periods, 30% dip 25 periods, >95% interruptions 250 periods | | | |
| OTHERS | MTBF | 487.7K hrs min. Telcordia SR-332 (Bellcore) ; 42.9K hrs min. MIL-HDBK-217F (25°C) | | | |
| | DIMENSION | 295*127*41mm (L*W*H) | | | |
| | PACKING | 1.95Kg; 6pcs/12.7Kg/1.15CUFT | | | |
| NOTE | <p>1. All parameters NOT specially mentioned are measured at 230VAC input, rated load and 25°C of ambient temperature.</p> <p>2. Ripple & noise are measured at 20MHz of bandwidth by using a 12" twisted pair-wire terminated with a 0.1uf & 47uf parallel capacitor.</p> <p>3. Tolerance : includes set up tolerance, line regulation and load regulation.</p> <p>4. Derating may be needed under low input voltages. Please check the derating curve for more details.</p> <p>5. Please contact MEANWELL for 320~370VDC application.</p> <p>6. The power supply is considered a component which will be installed into a final equipment. All the EMC tests are been executed by mounting the unit on a 720mm*360mm metal plate with 1mm of thickness. The final equipment must be re-confirmed that it still meets EMC directives. For guidance on how to perform these EMC tests, please refer to "EMI testing of component power supplies." (as available on https://www.meanwell.com/Upload/PDF/EMI_statement_en.pdf)</p> <p>7. The ambient temperature derating of 3.5°C/1000m with fanless models and of 5°C/1000m with fan models for operating altitude higher than 2000m(6500ft).</p> <p>※ Product Liability Disclaimer : For detailed information, please refer to https://www.meanwell.com/serviceDisclaimer.aspx</p> | | | | |

Block Diagram

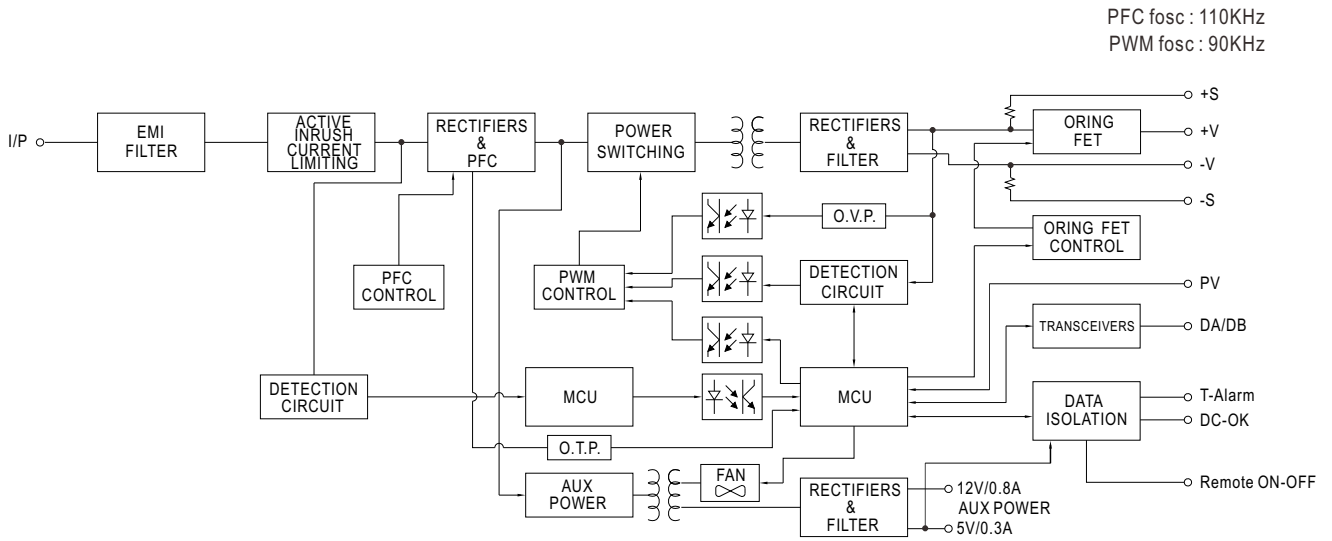

Static Characteristics

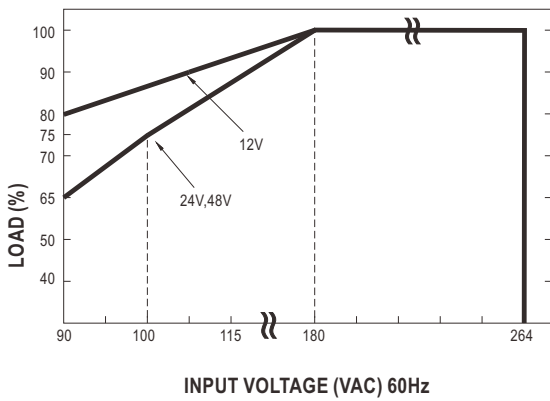

| INPUT \ MODEL | 12V | 24V | 48V |
|---------------|---------------|--------------|------------------|
| 180~264VAC | 1200W 100A | 1920W 80A | 2016W 42A |
| 115VAC | 1080W 90A | 1632W 68A | 1713.6W 35.7A |
| 100VAC | 1020W 85A | 1440W 60A | 1512W 31.5A |
| 90VAC | 960W 80A | 1248W 52A | 1310.4W 27.3A |

Derating Curve

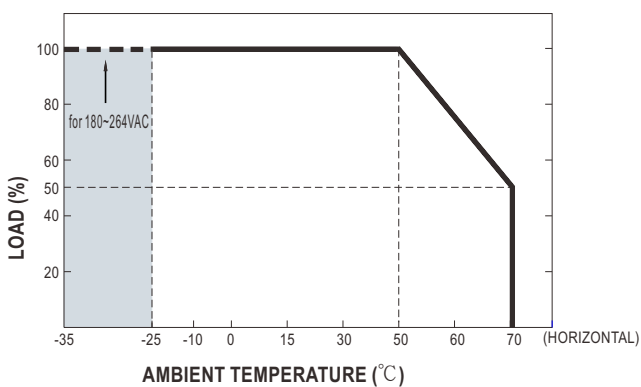

Efficiency vs Load (48V Model)

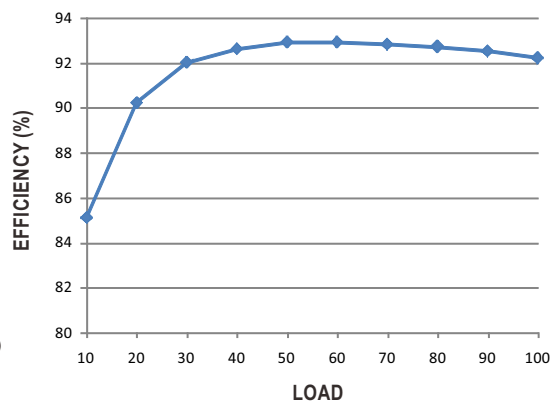

© The curve above is measured at 230VAC.

Function Manual

1. Remote Sense

※ The Remote Sense compensates voltage drop on the load wiring up to 0.5V

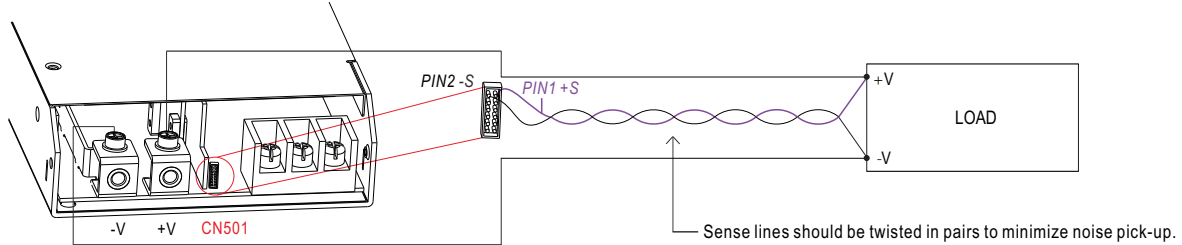

◎ The +S signal should be connected to the positive terminal of the load whereas -S signal to the negative terminal.

2. Output Voltage Programming (or, PV / remote voltage programming / remote adjust / margin programming / dynamic voltage trim)

※ In addition to the adjustment via the built-in potentiometer, the output voltage can be trimmed to 40~115% of the nominal voltage by applying EXTERNAL VOLTAGE.

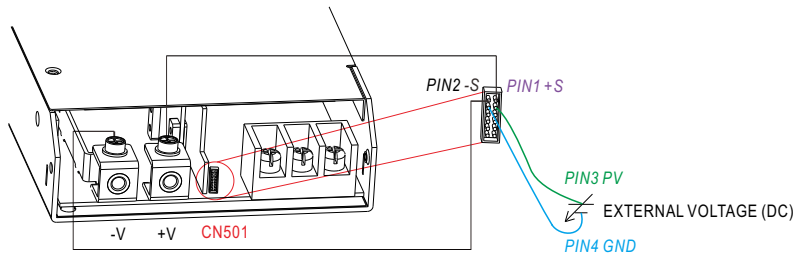

◎ +S & +V, -S & -V also need to be connected on CN501.

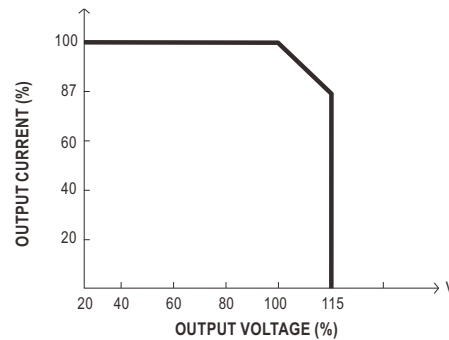
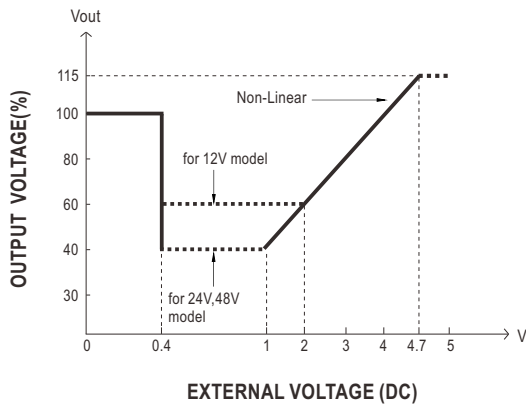

◎ The rated current should change with the Output Voltage Programming accordingly.

3. Remote ON-OFF Control

The power supply can be turned ON/OFF individually or along with other units by using the "Remote ON-OFF" function.

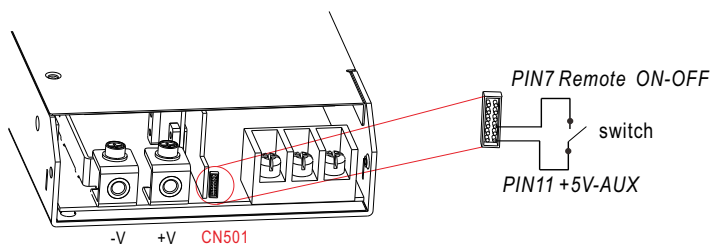

| Between Remote ON-OFF and +5V-AUX | Power Supply Status |
|-----------------------------------|---------------------|
| Switch Open | ON |
| Switch Short | OFF |

4. Current Sharing with Remote Sense

RSP-2000 has the built-in active current sharing function and can be connected in parallel, up to 4 units, to provide higher output power as exhibited below :

- ※ The power supplies should be paralleled using short and large diameter wiring and then connected to the load.
- ※ Difference of output voltages among parallel units should be less than 0.2V.
- ※ The total output current must not exceed the value determined by the following equation:

$$\text{Maximum output current at parallel operation} = (\text{Rated current per unit}) \times (\text{Number of unit}) \times 0.9$$
- ※ Under parallel operation, the minimum output load should be greater than 5% of total output load; otherwise, it is likely that only one unit operates whereas other units may enter standby mode or their LED status indicators may not turn on.
- ※ When the total output current is less than 5% of the total rated current, or say $(5\% \text{ of Rated current per unit}) \times (\text{Number of unit})$ the current shared among units may not be fully balanced.
- ※ CN502/CN504 Function pin connection

| Parallel | PSU1 | | PSU2 | | PSU3 | | PSU4 | |
|----------|-------|-------|-------|-------|-------|-------|-------|-------|
| | CN502 | CN504 | CN502 | CN504 | CN502 | CN504 | CN502 | CN504 |
| 1 unit | X | V | — | — | — | — | — | — |
| 2 unit | V | V | V | V | — | — | — | — |
| 3 unit | V | V | V | X | V | V | — | — |
| 4 unit | V | V | V | X | V | X | V | V |

◎ V is CN502/CN504 connected to plug pin, X is CN502/CN504 not connected to plug pin.

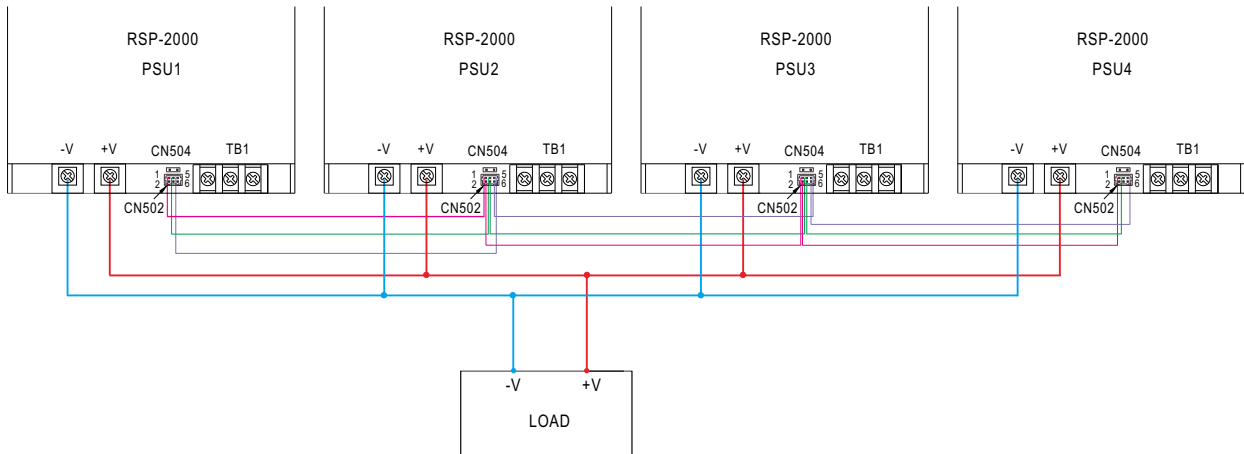
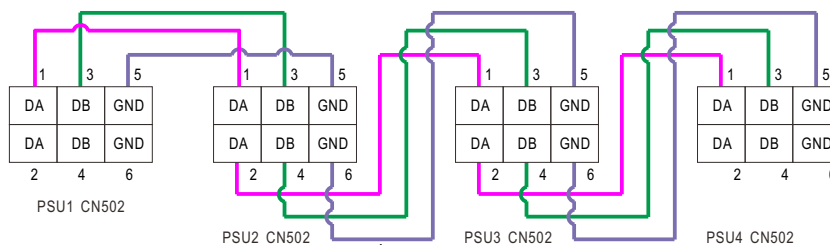

Fig 4.1



If the lines of CN502 are too long, they should be twisted in pairs to avoid the noise.

◎ DA, DB and GND are connected mutually in parallel.

Mechanical Specification

(Unit: mm , tolerance ±0.5mm)

Case No. 952D

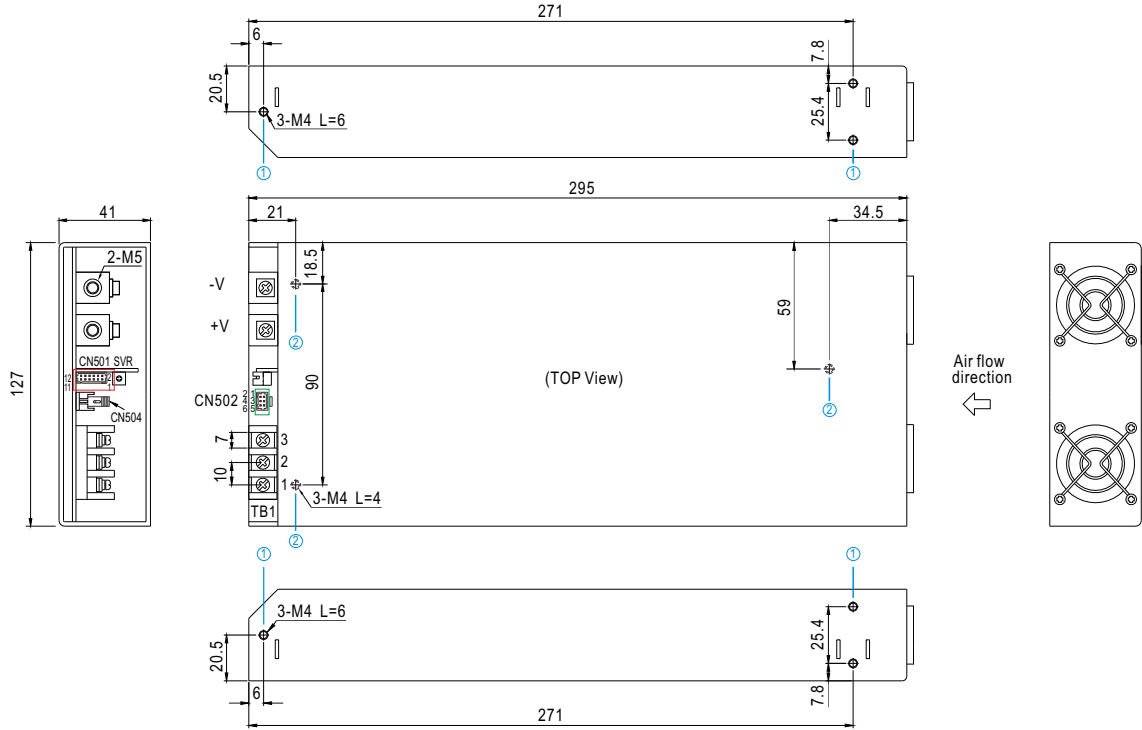

| Hole No. | Recommended Screw Size | MAX. Penetration Depth L | Recommended mounting torque |
|----------|------------------------|--------------------------|-----------------------------|
| ① | M4 | 6mm | 7~10Kgf-cm |
| ② | M4 | 4mm | 7~10Kgf-cm |

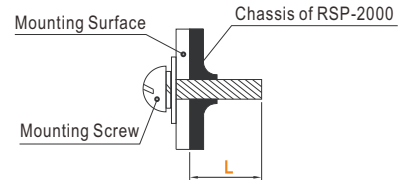

※Control Pin No. Assignment (CN501) : HRS DF11-12DP-2DS or equivalent

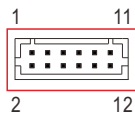

| | |
|----------------|-----------------------------|
| Mating Housing | HRS DF11-12DS or equivalent |
| Terminal | HRS DF11-12SC or equivalent |

| Pin No. | Function | Description |
|---------|---------------|--|
| 1 | +S | Positive sensing for remote sense. |
| 2 | -S | Negative sensing for remote sense. |
| 3 | PV | Connection for output voltage programming. (Note.1) |
| 4 | GND | This pin connect to the negative terminal(-V). |
| 5 | DC-OK | High (4.5 ~ 5.5V) : When the $V_{out} \leq 80\% \pm 6\%$. Low (0 ~ 0.5V) : When $V_{out} \geq 80\% \pm 6\%$. The maximum sourcing current is 10mA and only for output. (Note.2) |
| 6 | T-ALARM | High (4.5 ~ 5.5V) : When the internal temperature (TSW1 or TSW2 open) exceeds the limit of temperature alarm. Low (0 ~ 0.5V) : When the internal temperature (TSW1 or TSW2 short) under the limit temperature. The maximum sourcing current is 10mA and only for output. (Note.2) |
| 7 | Remote ON-OFF | The unit can turn the output on and off by electrical signal or dry contact between Remote ON-OFF and +5V-AUX. (Note.2) Short (4.5 ~ 5.5V) : Power OFF ; Open (0 ~ 0.5V) : Power ON ; The maximum input voltage is 5.5V. |
| 8,9,10 | GND-AUX | Auxiliary voltage output GND. The signal return is isolated from the output terminals (+V & -V). |
| 11 | +5V-AUX | Auxiliary voltage output, 4.5~5.5V, referenced to GND-AUX. The maximum load current is 0.3A. This output has the built-in "Oring diodes" and is not controlled by the Remote ON-OFF control. |
| 12 | +12V-AUX | Auxiliary voltage output, 10.6~13.2V, referenced to GND-AUX. The maximum load current is 0.8A. This output has the built-in "Oring diodes" and is not controlled by the Remote ON-OFF control. |

Note1: Non-isolated signal, referenced to the output terminals (-V).

Note2: Isolated signal, referenced to GND-AUX.

※LED Indicators & Corresponding Signal at Function Pins

| Function | LED | Description | * Signal | Power Supply Output |
|----------|---------|--|------------|---------------------|
| DC-OK | ● GREEN | When output voltage $\geq 80\% \pm 5\%$ of V_o rated. | 0 ~ 0.5V | ON |
| DC-NG | ● RED | When output voltage $\leq 80\% \pm 5\%$ of V_o rated. | 4.5 ~ 5.5V | ON |
| T-OK | ● GREEN | When the internal temperature (TSW1 & TSW2 short) is within safe limit | 0 ~ 0.5V | ON |
| T-ALARM | ● RED | When the internal temperature (TSW1 or TSW2 open) exceeds the limit of temperature alarm | 4.5 ~ 5.5V | OFF |

*Signal between function pin and "GND-AUX".

※Control Pin No. Assignment (CN502) : HRS DF11-6DP-2DSA or equivalent

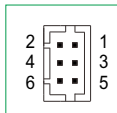

| | |
|----------------|------------------------------|
| Mating Housing | HRS DF11-6DS or equivalent |
| Terminal | HRS DF11-6**SC or equivalent |

| Pin No. | Function | Description |
|---------|----------|---|
| 1,2 | DA | Differential digital signal for parallel control. |
| 3,4 | DB | Differential digital signal for parallel control. |
| 5,6 | GND | These pins connect to the negative terminal (-V). |

※Control Pin No. Assignment (CN504):

| Pin No. | Function | Description |
|---------|---------------------|--|
| 1,2 | Terminal resistance | CN504 is the selector of terminal resistor that is designed for DA/DB signals and parallel control function. |

※AC Input Terminal Pin No. Assignment

| Pin No. | Assignment | Diagram | Maximum mounting torque |
|---------|------------|---------|-------------------------|
| 1 | AC/N | | 18Kgf-cm |
| 2 | AC/L | | |
| 3 | FG \perp | | |

※DC Output Terminal Pin No. Assignment

| Assignment | Diagram | Maximum mounting torque |
|------------|---------|-------------------------|
| +V, -V | | 10Kgf-cm |

■ Installation Manual

Please refer to : <http://www.meanwell.com/manual.html>