

SPECIFICATION

产品规格书

NO.(编号) : RD Version

Part No.(型号) : 5050A06-XXN75-U2S6P-V1-T-LX

Description(描述) : 5050 White LED

Model(说明) : EMC5050 6V CRI70

CUSTOMER APPEROVED (客户审核)	APPROVED (核准)	ISSUED (制定)
	朱磊	吴亮亮

SHINEON (NANCHANG) TECHNOLOGY CO.,LTD

699 Tianxiang Avenue, Building 7-1, CEC Low-Carbon Technology Park, High-Tech
Development District, Nanchang City, Jiangxi Province, P.R.China
TEL: 0791-88130119
<http://www.shineon.cn>

5050A06-XXN75-U2S6P-V1-T-LX Datasheet

This 5050 LED Light Source is a high performance energy efficient device which can handle high thermal and high driving current. The small package outline and high intensity make it an ideal choice for LED panel light, LED bulb light, LED tube light, backlighting and etc.

The White Power LED is available in the range of color temperature from 2700K to 6500K.

This part has a foot print that is compatible to most of the same size LED in the market today.

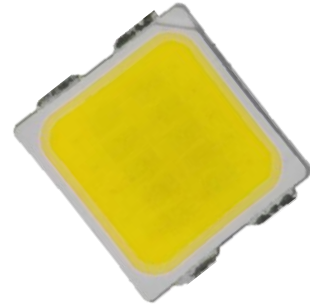

FEATURES

- Available in Cool White, Neutral White and Warm White color
- ANSI-compatible chromaticity bins
- High luminous Intensity and high efficiency
- Compatible with reflow soldering process
- Low thermal resistance
- Long operation life
- Wide viewing angle at 120°
- Silicone encapsulation
- EMC package
- Environmental friendly, RoHS compliance

APPLICATIONS

- Street lighting
- Par lighting
- Outdoor lighting

Note: The information in this document is subject to change without notice.

PACKAGE DIMENSIONS

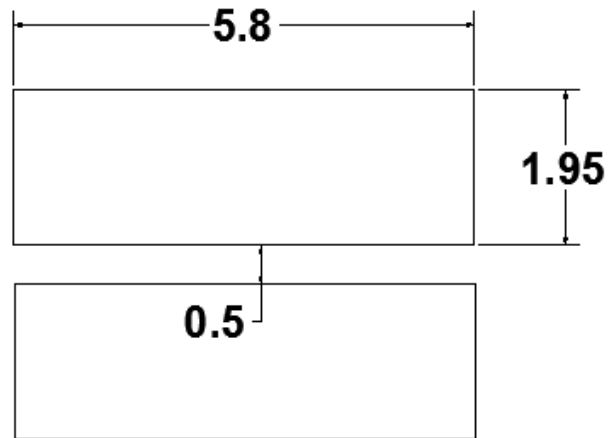
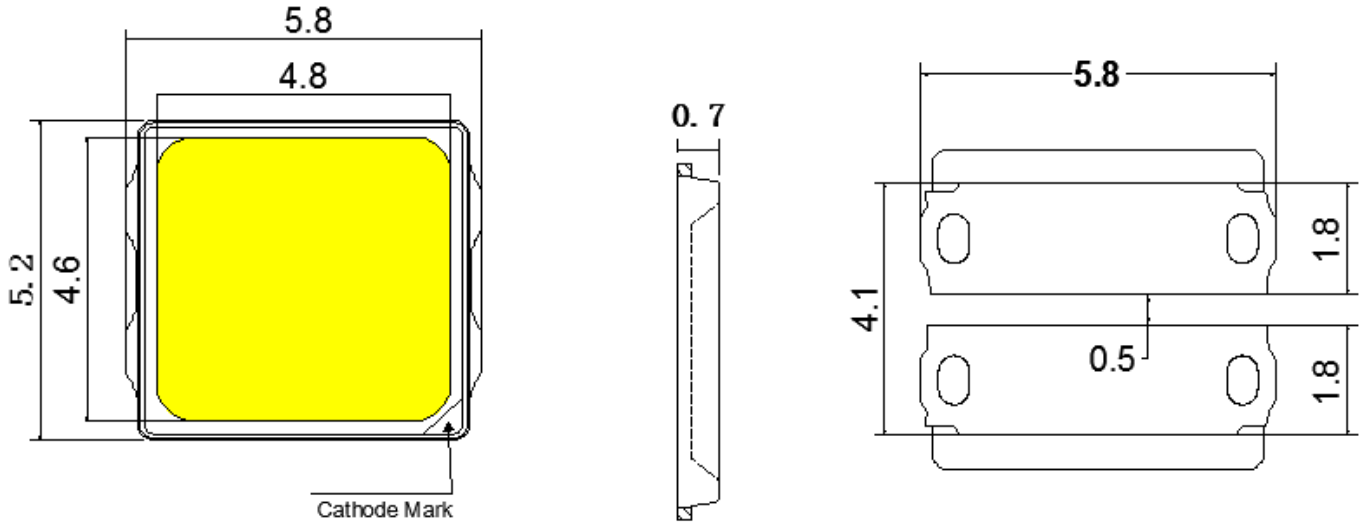

Recommended PCB Soldering Pad Pattern

Notes:

1. All dimensions in millimeters.
2. Thickness tolerance of copper plate is ± 0.02 mm.
3. Thickness tolerance of product is ± 0.05 mm.
4. Tolerance is ± 0.1 mm unless otherwise noted.

ABSOLUTE MAXIMUM RATINGS

Item	Symbol	Absolute Maximum Rating	Unit
Forward current	I_F	1000	mA
Peak Forward Current ^[1]	I_{FP}	1500	mA
Reverse Voltage	V_R	10	V
Power Dissipation	P_d	6700	mW
Operating solder point Temperature	T_{SP}	-40~+105	°C
Storage Temperature	T_{stg}	-40~+105	°C
Soldering Temperature	T_{sld}	Reflow Soldering: 260°C for 10 seconds	
LED Junction Temperature	T_j	125	°C
ESD Sensitivity (HBM)	--	2000	V

Note:

I_{FP} Conditions: Pulse Width ≤ 10 msec. and Duty $\leq 1/10$.

CHARACTERISTICS (T_j=25°C)

Parameter	Symbol	Condition	Min	Typ	Max	Unit
Forward Voltage ^[1]	V_F	IF=750mA	5.8	--	6.4	V
Viewing Angle	$2\theta_{1/2}$	IF=750mA	--	120	--	deg.
Luminous Flux	Φ_v	IF=750mA	--	--	950	lm
Color Rendering Index	CRI	IF=750mA	70	--	--	--
Color Temperature	CCT	IF=750mA	2700	--	6500	K
Thermal Resistance (Junction to Solder Point)	R_{th-js}	IF=750mA	--	3.0	--	°C/W

Notes:

- Luminous flux is measured with an accuracy of $\pm 10\%$.
- Chromaticity coordinate bins are measured with an accuracy of ± 0.01 .
- CRI is measured with an accuracy of ± 2 ;
- Some color and CRI bins may have limited availability, please contact us before ordering.
- All measurements were made under the standardized environment of Shineon

ELECTRO-OPTICAL CHARACTERISTICS 光电参数
(Tj=25°C; CRI70 ; 4000K)

Forward Current	Forward Voltage	Power	Luminous Flux	Luminous efficacy
	Typ	Typ	Typ	Typ
IF	VF	P	ΦV	η
100 mA	5.26 V	0.52 W	130 lm	245 lm/W
200 mA	5.41 V	1.08 W	260 lm	237 lm/W
300 mA	5.54V	1.66 W	380 lm	230 lm/W
400 mA	5.66 V	2.26 W	505 lm	222 lm/W
500 mA	5.77 V	2.88 W	622 lm	216 lm/W
600 mA	5.88 V	3.53 W	740 lm	209 lm/W
700 mA	5.93 V	4.19 W	855 lm	204 lm/W
800 mA	5.99 V	4.87 W	965 lm	198 lm/W
900 mA	6.09 V	5.57 W	1075 lm	193 lm/W
1000 mA	6.19 V	6.30 W	1180 lm	188 lm/W

Notes:

1. Luminous flux is measured with an accuracy of $\pm 10\%$.
2. Chromaticity coordinate bins are measured with an accuracy of ± 0.01 .
3. CRI is measured with an accuracy of ± 2 ;
4. Some color and CRI bins may have limited availability, please contact us before ordering.
5. All measurements were made under the standardized environment of Shineon

RELATIVE SPECTRAL POWER DISTRIBUTION (T_j=25°C)

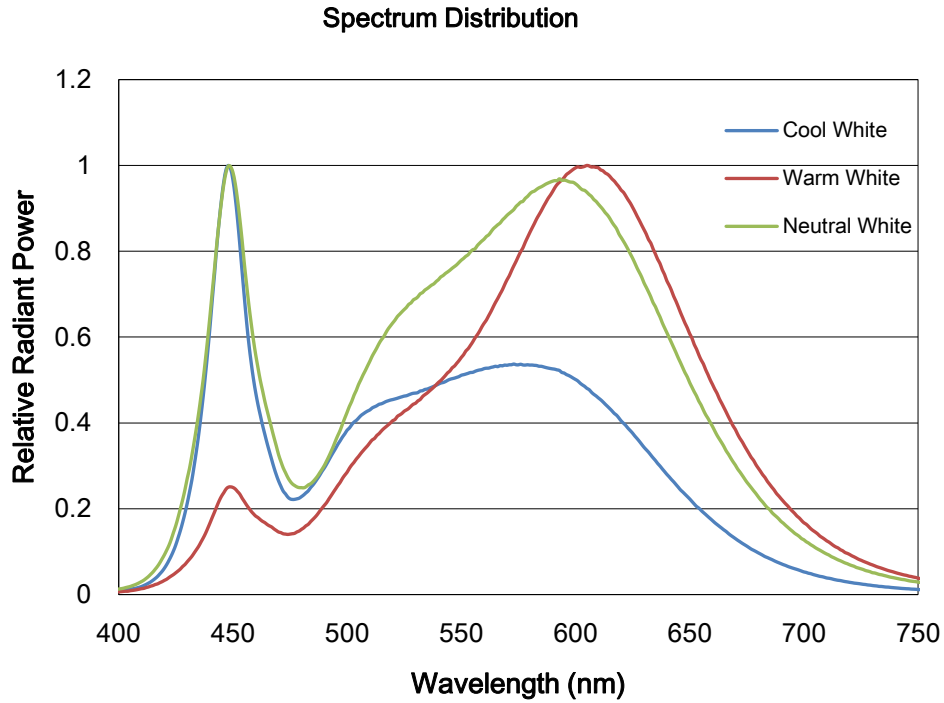

TYPICAL SPATIAL DISTRIBUTION

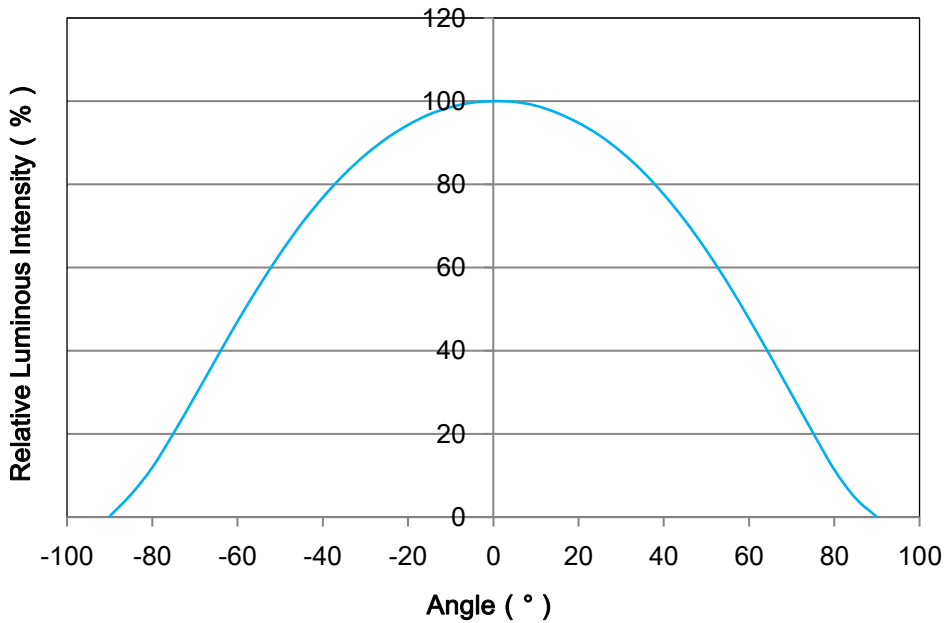

RELATIVE LUMINOUS FLUX VS. CURRENT ($T_j=25^\circ\text{C}$)

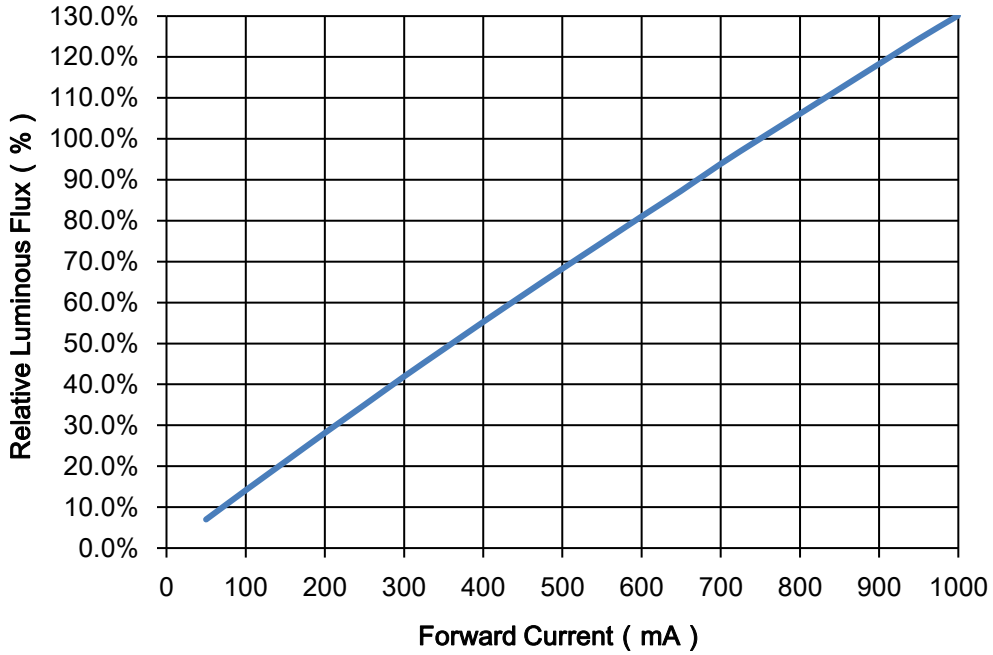

ELECTRICAL CHARACTERISTICS ($T_j=25^\circ\text{C}$)

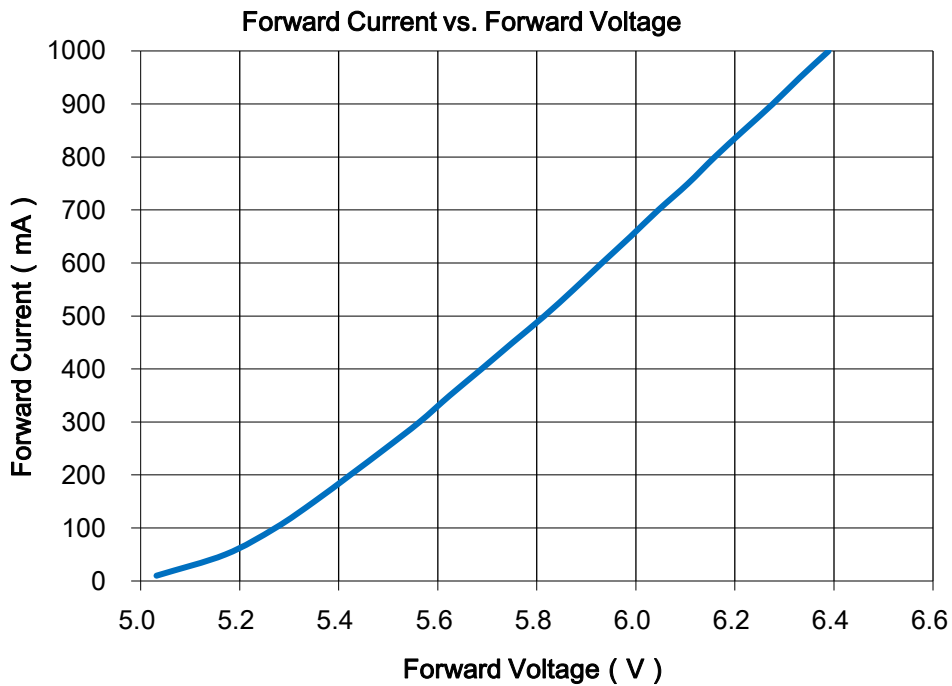

MAXIMUM CURRENT VS. AMBIENT TEMPERATURE

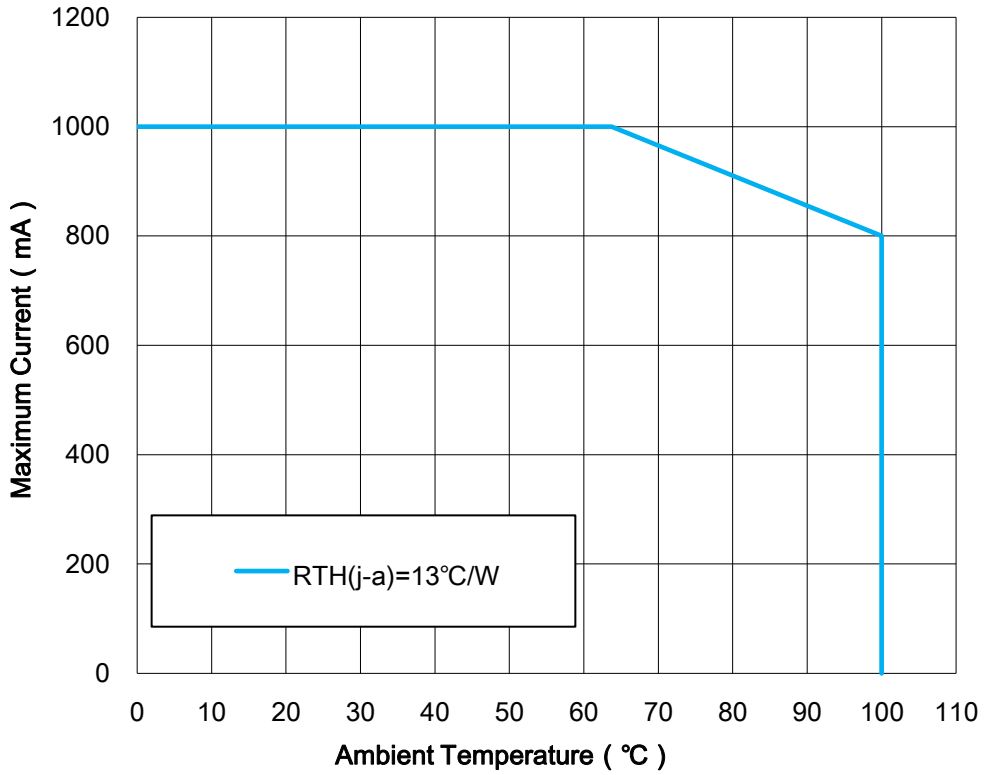

RELATIVE RADIANT FLUX VS. JUNCTION TEMPERATURE

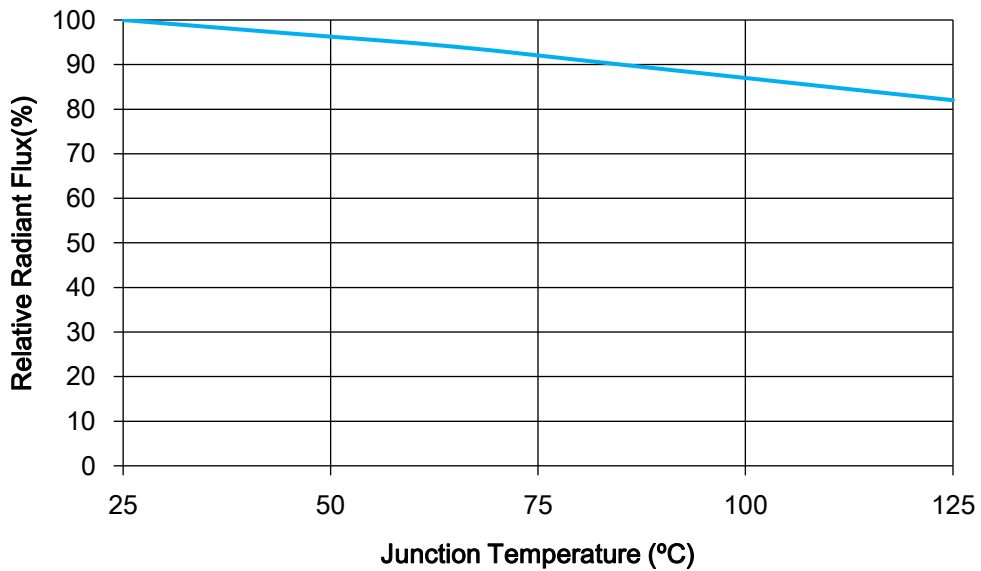

SORTING RANKS
(1) Luminous Flux (Tj=25°C)

Part Number	Condition	Rank	Unit
5050A06-27N75-U2S6P-V1-T-LX	750mA	X1	lm
		800-850	
5050A06-30N75-U2S6P-V1-T-LX		X4	
		850-900	
5050A06-40N75-U2S6P-V1-T-LX		Y0	
		900-950	
5050A06-50N75-U2S6P-V1-T-LX		Y0	
		900-950	
5050A06-57N75-U2S6P-V1-T-LX		Y0	
		900-950	
5050A06-60N75-U2S6P-V1-T-LX		Y0	
		900-950	
5050A06-65N75-U2S6P-V1-T-LX	X6		
	880-930		

(2) Forward Voltage (Tj=25°C)

Rank	Condition	Min.	Max.	Unit
C9	750mA	5.8	6.0	V
D0		6.0	6.2	
D1		6.2	6.4	

Notes:

- 10% tolerance for luminous intensity may be caused by measurement inaccuracy.
- Measurement Uncertainty of the Forward Voltage : $\pm 0.06V$

(3) Chromaticity Bins

Part Number	5050A06-27N75-U2S6P-V1-T-LX			CCT	2700K
Bin Code	Color Coordinates(x,y)				
A27-5	x	y	a	b	Theta°
		0.4578	0.4101	0.01350	0.0070

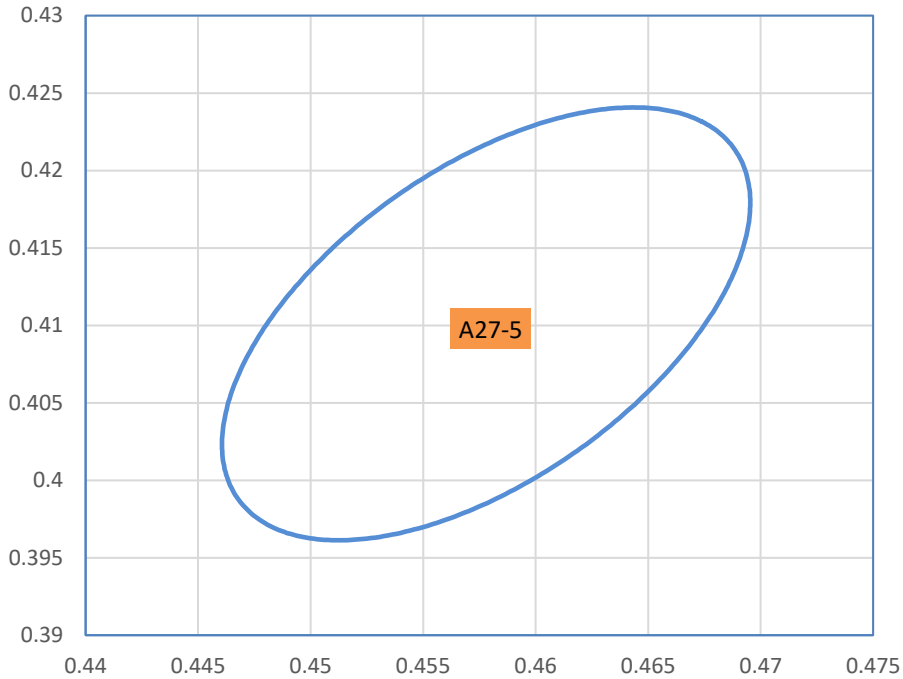

Part Number	5050A06-30N75-U2S6P-V1-T-LX			CCT	3000K
Bin Code	Color Coordinates(x,y)				
A30-5	x	y	a	b	Theta°
	0.4338	0.4030	0.0139	0.0068	53.22

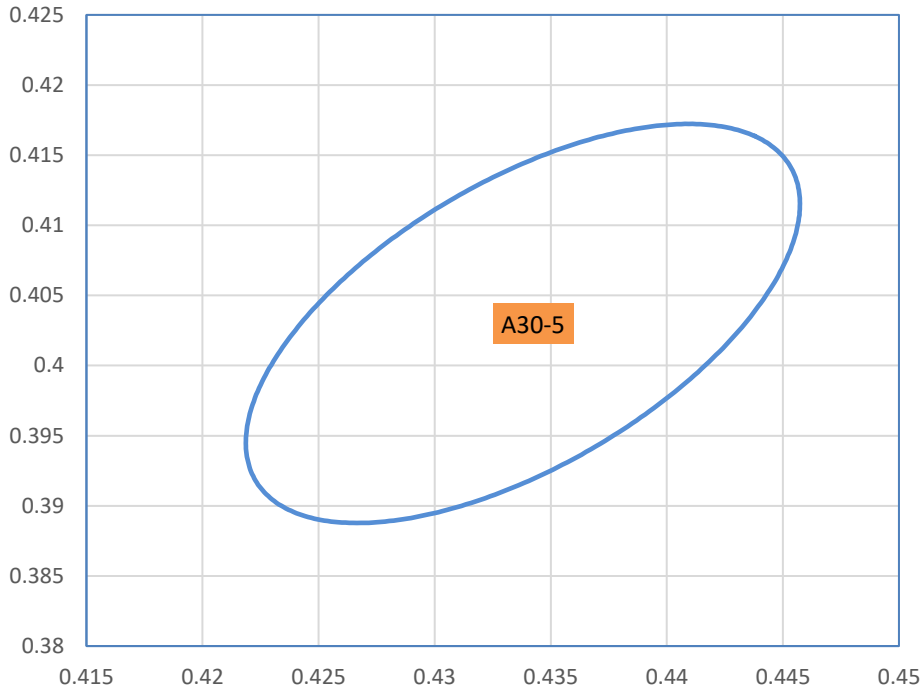

Part Number	5050A06-40N75-U2S6P-V1-T-LX			CCT	4000K
Bin Code	Color Coordinates(x,y)				
A40-5	x	y	a	b	Theta°
	0.3818	0.3797	0.01565	0.0067	53.72

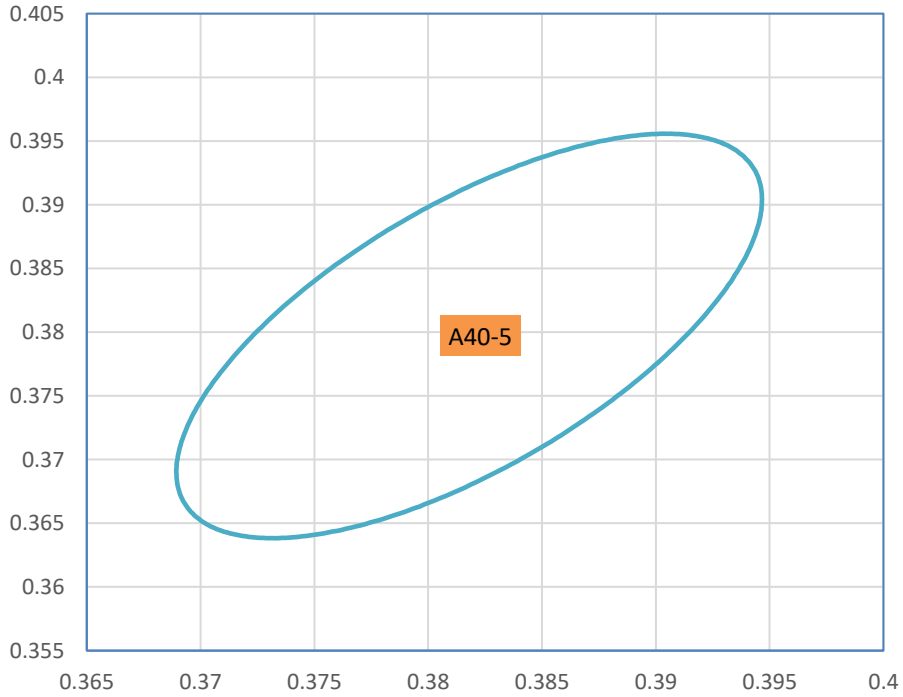

Part Number	5050A06-50N75-U2S6P-V1-T-LX			CCT	5000K
Bin Code	Color Coordinates(x,y)				
A50-5	x	y	a	b	Theta°
	0.3447	0.3553	0.0137	0.0059	59.62

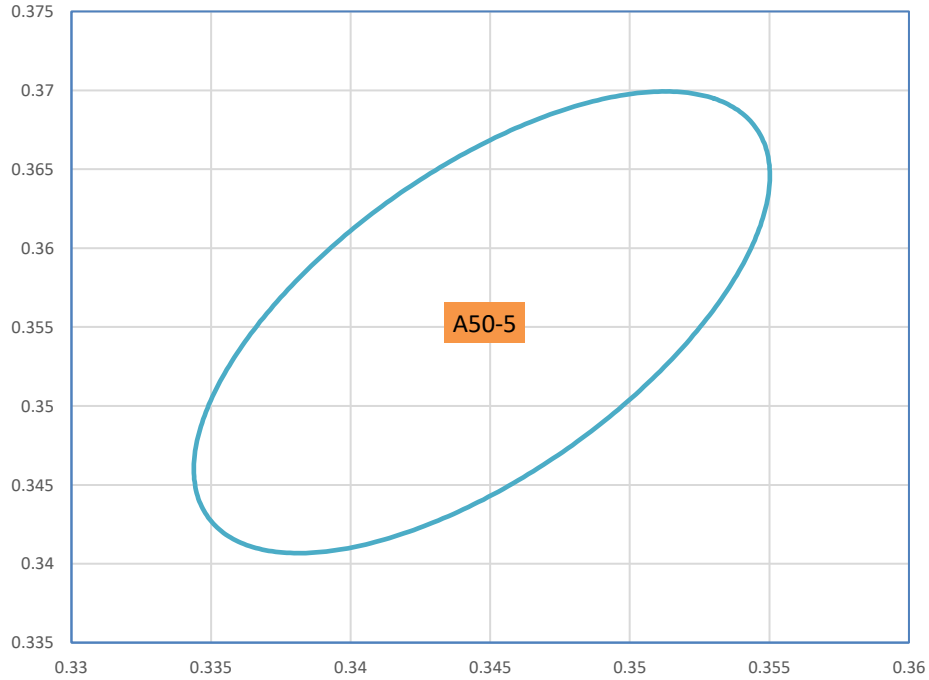

Part Number	5050A06-57N75-U2S6P-V1-T-LX			CCT	5700K
Bin Code	Color Coordinates(x,y)				
A57-5	x	y	a	b	Theta°
	0.3287	0.3417	0.01243	0.00533	59.09

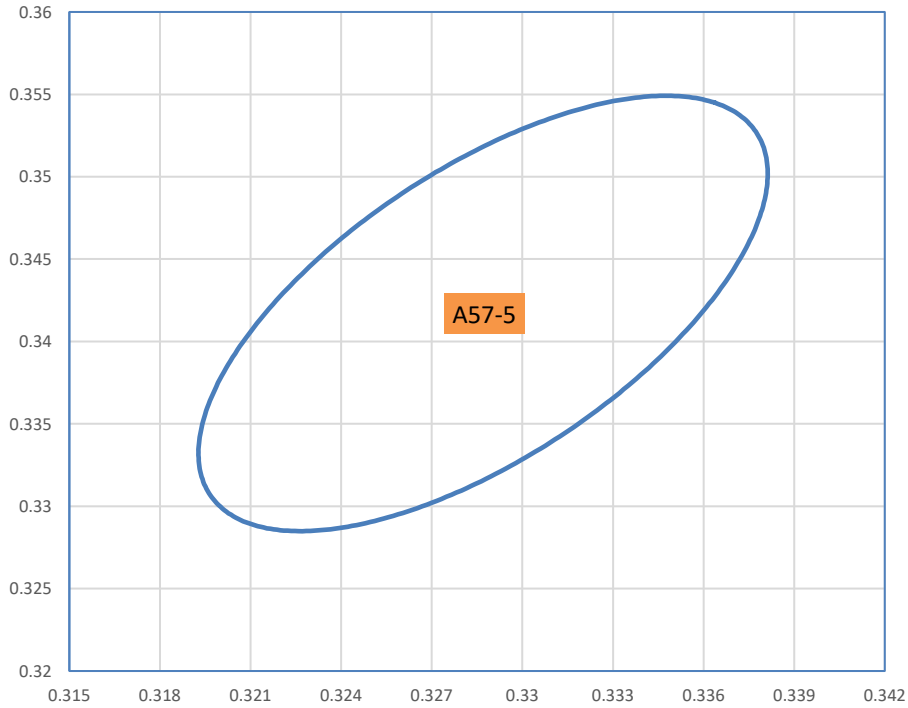

Part Number	5050A06-60N75-U2S6P-V1-T-LX	CCT	6000K		
Bin Code	Color Coordinates(x,y)				
A60-5	x	y	a	b	Theta°
	0.322	0.3365	0.01179	0.00504	59.21

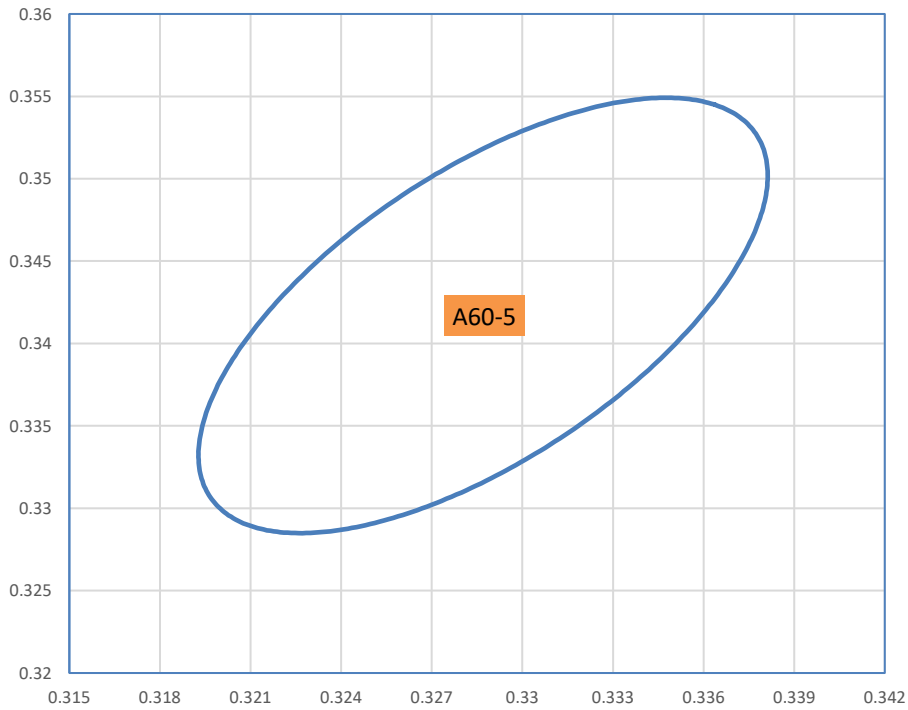

Part Number	5050A06-65N75-U2S6P-V1-T-LX			CCT	6500K
Bin Code	Color Coordinates(x,y)				
A65-5	x	y	a	b	Theta°
	0.3123	0.3282	0.01115	0.00475	58.57

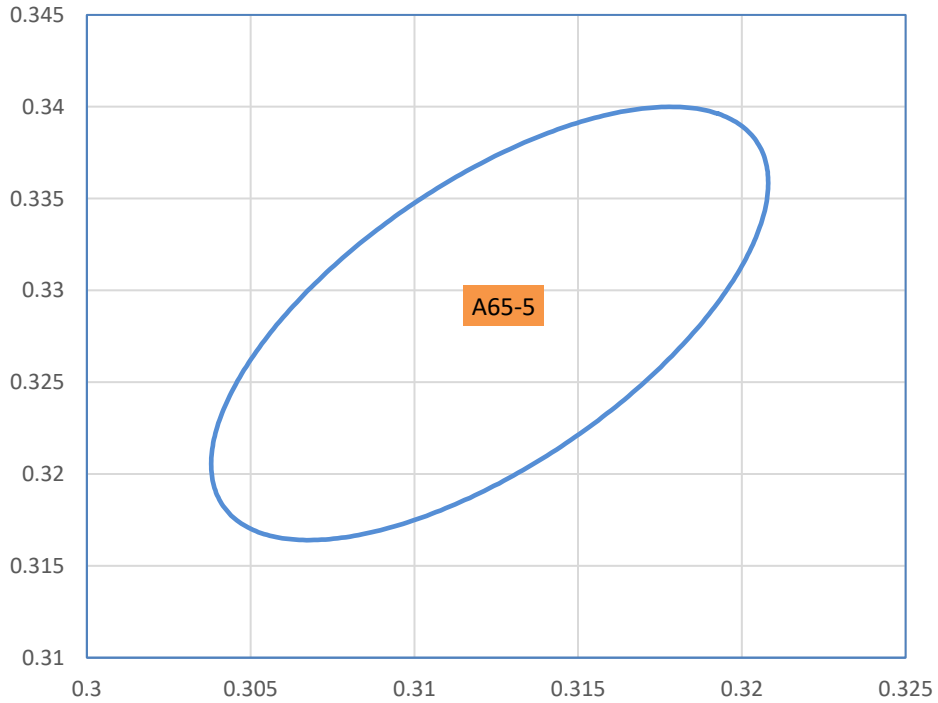

REFLOW SOLDERING CHARACTERISTICS

For Reflow Process:

Preheating : 140°C~160°C±5°C, within 2 minutes.

Operation heating : 260°C(Max.) within 10 seconds.(Max)

Gradual Cooling (Avoid quenching).

Lead solder		Lead-free solder	
Pre-heat	120-150°C	Pre-heat	150-200°C
Pre-heat time	120 sec.Max.	Pre-heat time	120 sec.Max.
Peak Temperature	240°C Max.	Peak Temperature	260°C Max.
Soldering time condition	10 sec.Max.	Soldering time condition	10 sec.Max.

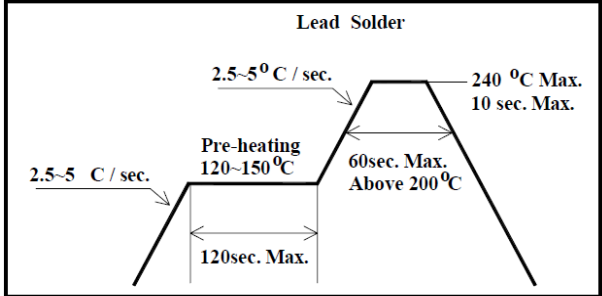
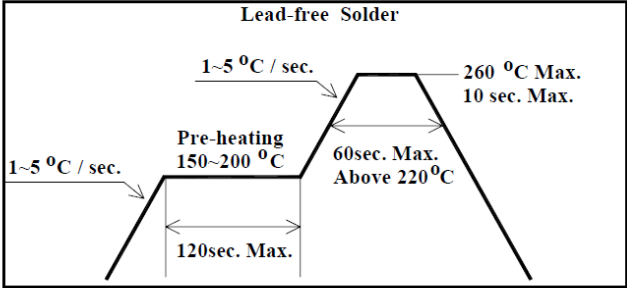
Lead Solder	Lead-free Solder
 <p>The diagram shows a reflow profile for Lead Solder. It starts with a heating phase at 2.5-5 °C/sec. This is followed by a pre-heating phase at 120-150 °C for a maximum of 120 seconds. The temperature then rises at 2.5-5 °C/sec to a peak of 240 °C, which is maintained for a maximum of 10 seconds. The cooling phase is gradual, with a maximum of 60 seconds above 200 °C.</p>	 <p>The diagram shows a reflow profile for Lead-free Solder. It starts with a heating phase at 1-5 °C/sec. This is followed by a pre-heating phase at 150-200 °C for a maximum of 120 seconds. The temperature then rises at 1-5 °C/sec to a peak of 260 °C, which is maintained for a maximum of 10 seconds. The cooling phase is gradual, with a maximum of 60 seconds above 220 °C.</p>

Notes:

The encapsulated material of the LEDs is silicone . Therefore the LEDs have a soft surface on the top of package. The pressure to the top surface will be influence to the reliability of the LEDs. Precautions should be taken to avoid the strong pressure on the encapsulated part. So when using the picking up nozzle, the pressure on the silicone resin should be proper.

TAPE AND REEL

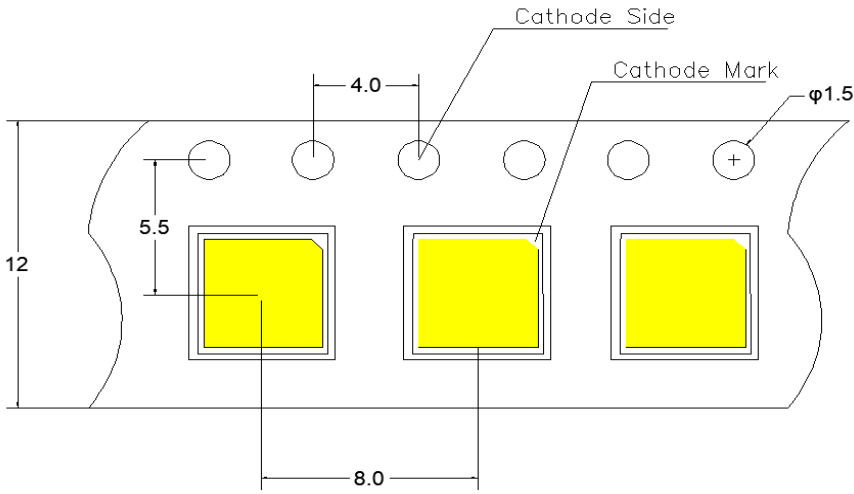

Small reel

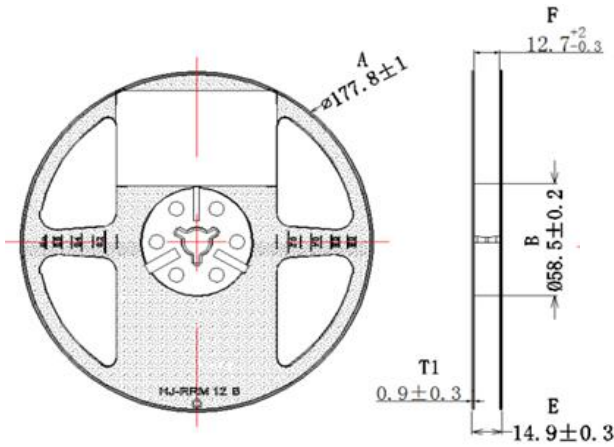

Big reel

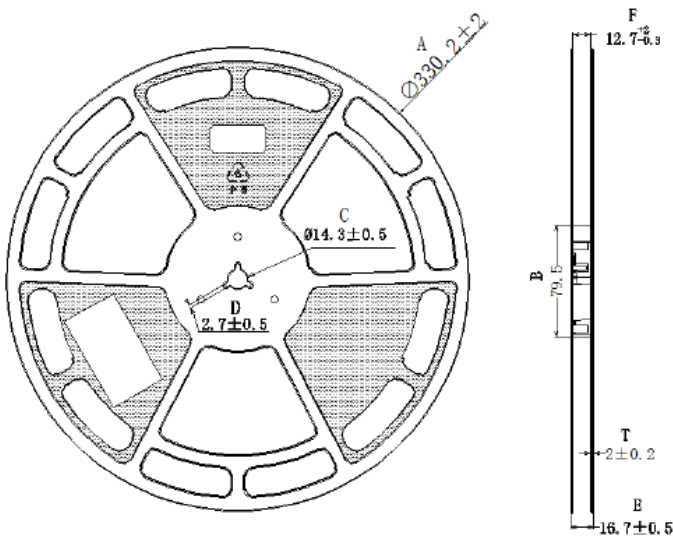

Notes:

- (1) Quantity : 1500pcs/Reel OR 5,000pcs/Reel
- (2) Cumulative Tolerance : Cumulative Tolerance/10 pitches to be $\pm 0.2\text{mm}$
- (3) Adhesion Strength of Cover Tape : Adhesion strength to be 0.1-0.7N when the cover tape is turned off from the carrier tape at the angle of 10° to the carrier tape
- (4) Package : P/N, Manufacturing data Code No. and quantity to be indicated on a damp proof Package.

PACKAGING



REEL

Label

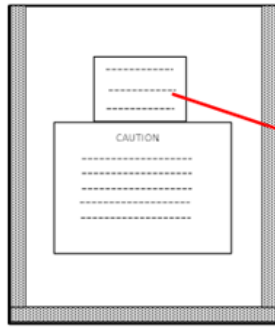

moisture-proof bag

Label

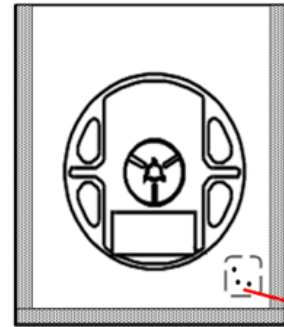

desiccant

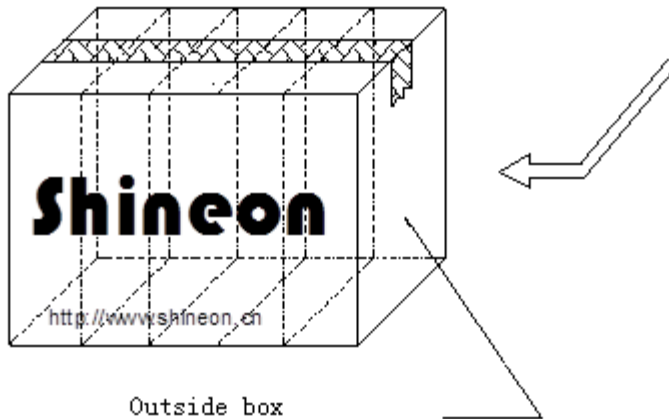

Outside box

Notes:

- (1) Box size: 33x25x42cm 60K/Box 1500pcs/Reel
- (2) Box size: 38x36x42cm 80K/Box 5000pcs/Reel,

Reliability Test Items

Test Items	Test Duration	Number of Damaged
Steady State Operating Life of High Temperature (HTOL) Ts=85°C, IF=Max	1000hrs	0/20
Steady State Operating Life of Low Temperature (LTOL) Ta=-40°C, IF=Max	1000hrs	0/20
High Temperature Storage (HTS) 100°C	1000hrs	0/20
Low Temperature Storage (LTS) -40°C	1000hrs	0/20
Thermal Shock (TS) -45°C~125°C 15min dwell 30sec transfer	100cycles	0/20
Solder Resistance (SR) 265°C, 3X MSL	5sec	0/20
Solder Ability (SA) 245°C5sec, 95% coverage	5sec	0/11
Mechanical Shock (MS) 1500G 0.5msec pulse shock	Each6 axis	0/6
Random Vibration (RV) 6G RMS, 10-2000Hz, 10min	Per axis	0/6
Variable Vibration Frequency (VVF) 10-2000-10Hz, log or linear sweep rate, 20G for 1 min, 1.5mm each apply 3x per axis over	6hrs	0/6

Item	Symbol	Test Condition	Criteria for Judgment	
			Min.	Max.
Forward	Vf	IF=Typical Current		U.S.L x1.1
Luminous Flux	lm	IF=Typical Current	L.S.L x0.7	
CCX&CCY	x,y	IF=Typical Current		Shift<0.02

PRECAUTION FOR USE

- (1) This device should not be used in any type of fluid such as water, oil, organic solvent, etc. When washing is required, IPA should be used.
- (2) When the LEDs are illuminating, operating current should be decided after considering the ambient maximum temperature.
- (3) LEDs must be stored to maintain a clean atmosphere. If the LEDs are stored for 3 months or more after being shipped from ShineOn, a sealed container with a nitrogen atmosphere should be used for storage.
- (4) The LEDs must be used within seven days after opening the moisture proof packing. Repack unused Products with anti-moisture packing, fold to close any opening and then store in a dry place.
- (5) The appearance and specifications of the product may be modified for improvement without notice.
- (6) This LED is sensitive to the static electricity and surge. It is recommended to use a wrist Band or anti-electrostatic glove when handling the LEDs.
- (7) On manual soldering, a solder tip must be needed as grounded for usage. If over voltage which exceeds the absolute maximum rating is applied to LEDs, it will cause damage LEDs and result in destruction. Damaged LEDs will show some unusual characteristics such as leak current remarkably increase ,turn-on voltage becomes lower and the LEDs get unlighted at low current.