

HF7520

SUBMINIATURE POWER RELAY



File No.: E133481



File No.: R50351269



File No.: CQC09002034524

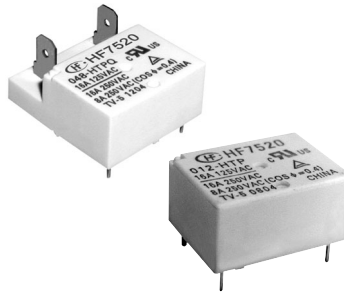

Features

- High rating: 16A/20A
- TV-5/TV-8 load capability
- High sensitive: 200mW
- Low height, flat construction
- PCB & QC layouts available
- Plastic sealed and flux proofed types (with vent-hole cover) available
- UL insulation system: Class F
- Product in accordance to EN 60335-1 available

CONTACT DATA

| | | |
|----------------------------------|--------------------------|---|
| Arrangement | 1C | 1A |
| Contact resistance ¹⁾ | 100mΩ max.(at 1A 6VDC) | |
| Contact material | See ordering info. | |
| Contact rating (Res. load) | NO: 10A 125/250VAC | Standard type: TV-5 10A 30VDC 10A 125/250VAC |
| | NC: 6A 125/250VAC | High capacity type: TV-5 TV-8 16A 30VDC 16A 125VAC/250VAC 20A 125VAC/250VAC 8A 250VAC(COSØ=0.4) |
| Max.switching voltage | 250VAC | 277VAC / 30VDC |
| Max.switching current | NO:10A NC: 6A | 20A |
| Max.switching power | NO: 2500VA NC: 1500VA | 5000VA/480W |
| Mechanical endurance | 1 x 10 ⁷ ops | |

| | |
|----------------------|---|
| Electrical endurance | HP type: 5 x 10 ⁴ ops (16A 250VAC, Resistive load, Room temp., 1s on 9s off) |
| | HP type(979): 5 x 10 ⁴ ops (16A 250VAC, Resistive load, Room temp., 1s on 9s off) TV-8 HP type(530): 5 x 10 ⁴ ops (20A 250VAC, Resistive load, Room temp., 1s on 9s off) H type: 5 x 10 ⁴ ops (10A 250VAC, Resistive load, Room temp., 1s on 9s off) Z type: 5 x 10 ⁴ ops (NO, 10A 250VAC, Resistive load, Room temp., 1s on 9s off) Z type: 5 x 10 ⁴ ops (NC, 6A 250VAC, Resistive load, Room temp., 1s on 9s off) |

Notes: 1) The data shown above are initial values.
2) For plastic sealed type, the venting-hole should be opened in electrical endurance test.

COIL

| | |
|------------|---|
| Coil power | 1 Form A: Approx. 200mW; 1 Form C: Approx. 400mW |
|------------|---|

CHARACTERISTICS

| | | |
|-------------------------------|------------------------------------|---------------------|
| Insulation resistance | 1000MΩ (at 500VDC) | |
| Dielectric strength | Between coil & contacts | 2500VAC 1 min |
| | Between open contacts | 1000VAC 1 min |
| Operate time (at rated.volt) | 15ms max. | |
| Release time (at rated.volt) | 5ms max. | |
| Shock resistance | Functional | 98m/s ² |
| | Destructive | 980m/s ² |
| Vibration resistance | 10Hz to 55Hz 1.5mm DA | |
| Humidity | 5% to 85% RH | |
| Ambient operating temperature | -40°C to 105°C | |
| Termination | 1C: PCB 1A: PCB & QC | |
| Unit weight | PCB: Approx.9g QC: Approx.10.5g | |
| Construction | Plastic sealed, Flux proofed | |

Notes: 1) The data shown above are initial values.
2) Please find coil temperature curve in the characteristic curves below.

SAFETY APPROVAL RATINGS

| | | |
|--------|----------|---|
| UL/CUL | 1 Form A | 10A 250VAC 85°C Standard type 16A 125VAC 85°C HP type 20A 250VAC 85°C HP type(530) 16A 30VDC 85°C HP type 0.3A 110VDC 85°C HP type 13A 125VAC 105°C HP type 10A 250VAC 105°C HP type TV-5 120VAC HP type TV-8 120VAC HP type(979) Electronic Ballast 5A 120VAC 85°C HP type(530) 1/2HP 120VAC HP type(530) 1HP 250VAC HP type(530) |
| | 1 Form C | NO: 10A 250VAC NC: 6A 250VAC |
| TÜV | 1 Form A | 16A 250VAC HP type 10A 30VDC HP type 20A 250VAC HP type(530) 8A 250VAC cosØ=0.4 HP type |

Notes: 1) All values unspecified are at room temperature.
2) Only typical loads are listed above. Other load specifications can be available upon request.



HONGFA RELAY

ISO9001, IATF16949, ISO14001, ISO45001, IECQ QC 080000 CERTIFIED

2023 Rev. 1.00

COIL DATA

at 23°C

1 Form C type

| Nominal Voltage VDC | Pick-up Voltage VDC max. ¹⁾ | Drop-out Voltage VDC min. ¹⁾ | Max. Voltage VDC ⁺²⁾ | Coil Resistance Ω |
|---------------------|--|---|---------------------------------|-------------------|
| 5 | 4.0 | 0.5 | 6.5 | 62.5 x (1±10%) |
| 6 | 4.8 | 0.6 | 7.8 | 90 x (1±10%) |
| 9 | 7.2 | 0.9 | 11.7 | 202.5 x (1±10%) |
| 12 | 9.6 | 1.2 | 15.6 | 360 x (1±10%) |
| 18 | 14.4 | 1.8 | 23.4 | 810 x (1±10%) |
| 24 | 19.2 | 2.4 | 31.2 | 1440 x (1±10%) |
| 48 | 38.4 | 4.8 | 62.4 | 5760 x (1±10%) |

1 Form A type

| Nominal Voltage VDC | Pick-up Voltage VDC max. ¹⁾ | Drop-out Voltage VDC min. ¹⁾ | Max. Voltage VDC ⁺²⁾ | Coil Resistance Ω |
|---------------------|--|---|---------------------------------|-------------------|
| 5 | 4.0 | 0.5 | 6.5 | 125 x (1±10%) |
| 6 | 4.8 | 0.6 | 7.8 | 180 x (1±10%) |
| 9 | 7.2 | 0.9 | 11.7 | 405 x (1±10%) |
| 12 | 9.6 | 1.2 | 15.6 | 720 x (1±10%) |
| 18 | 14.4 | 1.8 | 23.4 | 1620 x (1±10%) |
| 24 | 19.2 | 2.4 | 31.2 | 2880 x (1±10%) |
| 48 | 38.4 | 4.8 | 62.4 | 11520 x (1±10%) |

Notes:1) The data shown above are initial values.

2)*Maximum voltage refers to the maximum voltage which relay coil could endure in a short period of time.

ORDERING INFORMATION

| | |
|----------------------------|--|
| Type | HF7520 / 012 -H S T P Q (XXX) |
| Coil voltage | 5, 6, 9,12, 18, 24, 48VDC |
| Contact arrangement | H: 1 Form A Z: 1 Form C |
| Construction ¹⁾ | S: Plastic sealed Nil: Flux proofed |
| Contact material | T: AgSnO ₂ Nil: AgCdO (Only for 1 Form A) AgNi (Only for 1 Form C) |
| Contact capacity | P: High Capacity type (Only for 1 Form A) Nil: Standard type |
| Terminal type | Q: QC (Only for 1 Form A and high capacity type) Nil: PCB |
| Special code ⁴⁾ | XXX: Customer special requirement Nil: Standard |

Notes: 1) We recommend flux proofed types for a clean environment (free from contaminations like H₂S, SO₂, NO₂, dust, etc.).

We suggest to choose plastic sealed types and validate it in real application for an unclean environment (with contaminations like H₂S, SO₂, NO₂, dust, etc.).

2) Contact is recommended for suitable condition and specifications if water cleaning or surface process is involved in assembling relays on PCB.

3) When the ambient temperature reaches 105°C degree or more, please select flux proofed and high capacity type. Besides, please indicate the exact ambient temperature when ordering.

4) The customer special requirement express as special code after evaluating by Hongfa.

1 Form A (PCB)

Outline Dimensions

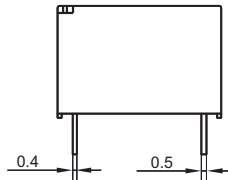
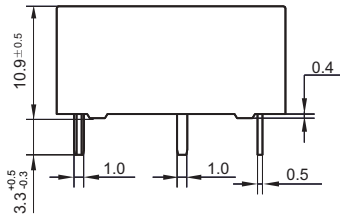

Wiring Diagram
(Bottom View)

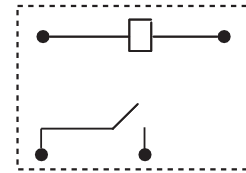

PCB Layout
(Bottom view)

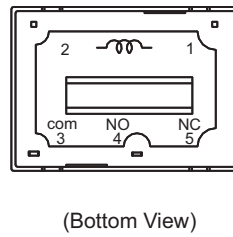
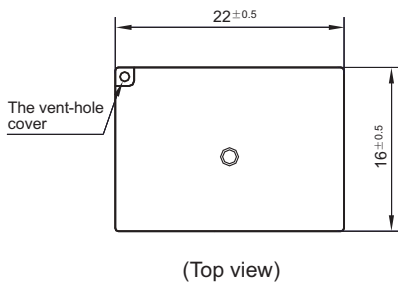
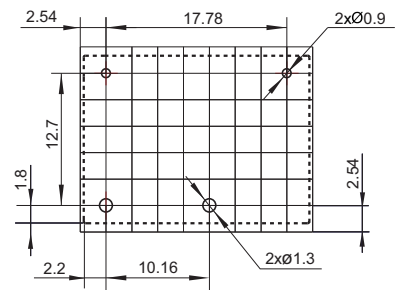

1 Form A (Wide terminal)

Outline Dimensions

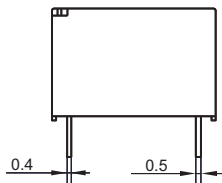
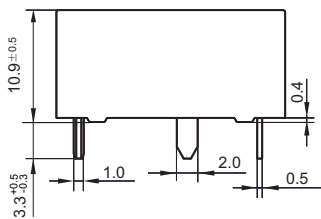

Wiring Diagram

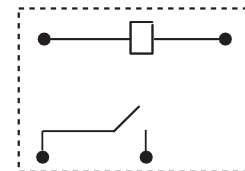

PCB Layout
(Bottom view)

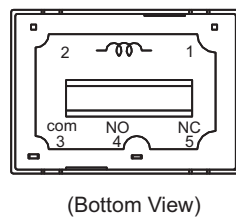
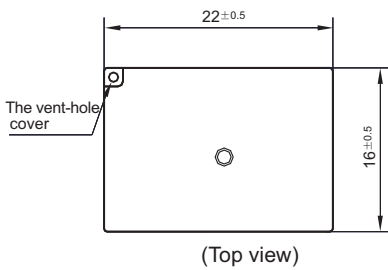
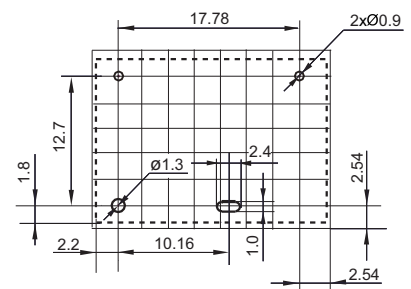

OUTLINE DIMENSIONS , WIRING DIAGRAM AND PC BOARD LAYOUT

Unit: mm

1 Form A (Wide terminal) (530/979)

Outline Dimensions

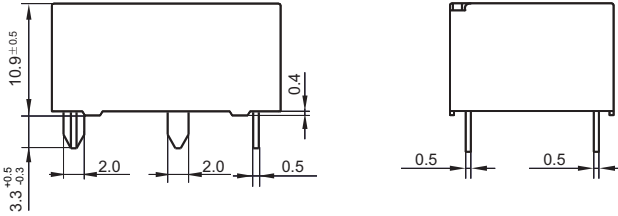

Wiring Diagram

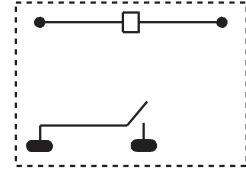

PCB Layout (Bottom view)

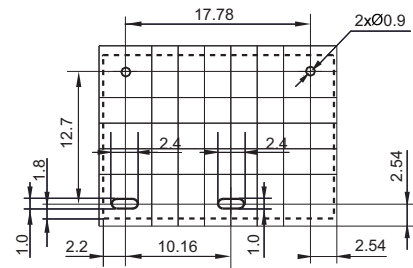
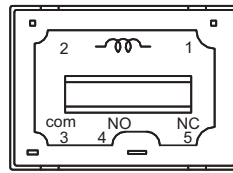
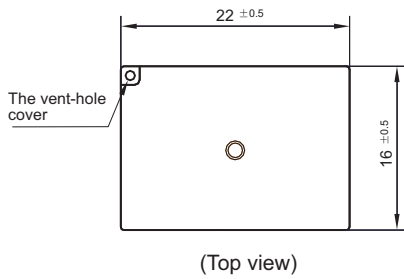

1 Form A (QC)

Outline Dimensions

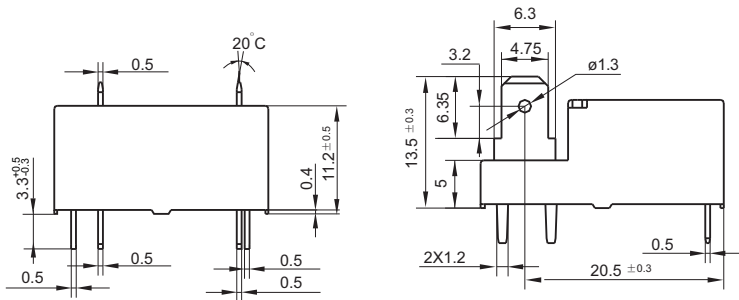

Wiring Diagram

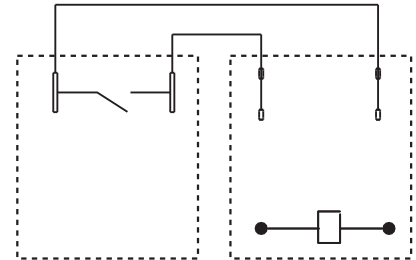

PCB Layout (Bottom view)

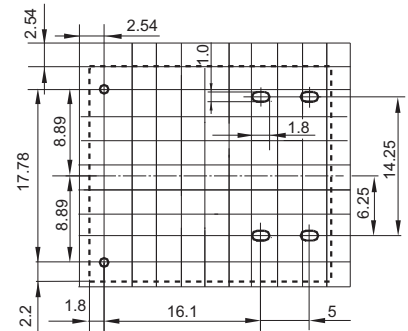
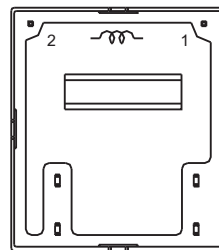
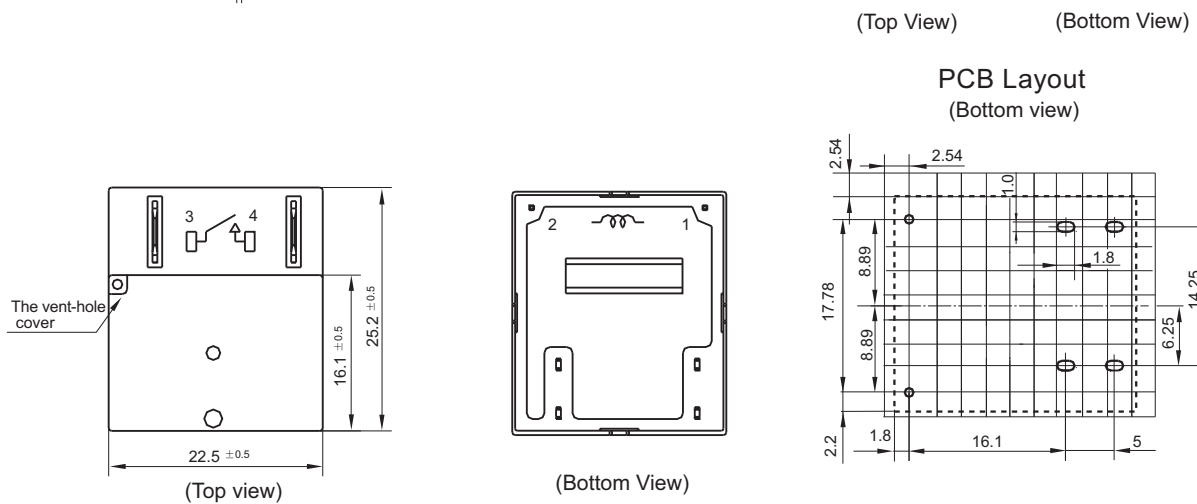

OUTLINE DIMENSIONS , WIRING DIAGRAM AND PC BOARD LAYOUT

Unit: mm

1 Form C (PCB)

Outline Dimensions

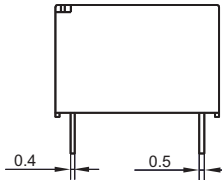
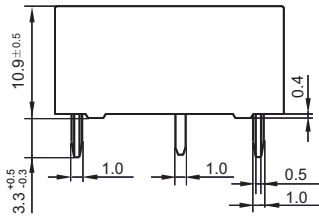

Wiring Diagram (Bottom View)

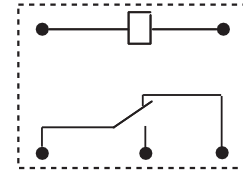

PCB Layout (Bottom view)

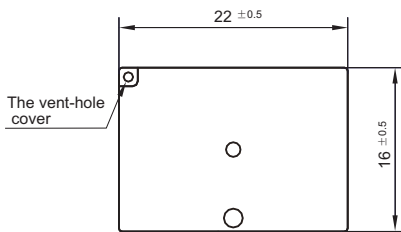

(Top view)

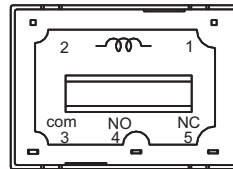

(Bottom View)

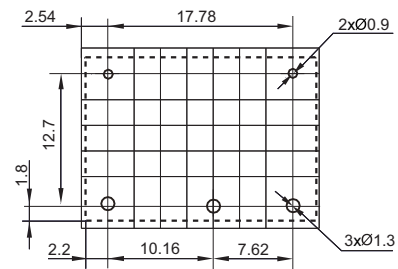

Remark: 1) In case of no tolerance shown in outline dimension: outline dimension $\leq 1\text{mm}$, tolerance should be $\pm 0.2\text{mm}$; outline dimension $> 1\text{mm}$ and $\leq 5\text{mm}$, tolerance should be $\pm 0.3\text{mm}$; outline dimension $> 5\text{mm}$, tolerance should be $\pm 0.4\text{mm}$.
2) The tolerance without indicating for PCB layout is always $\pm 0.1\text{mm}$.

CHARACTERISTIC CURVES

MAXIMUM SWITCHING POWER

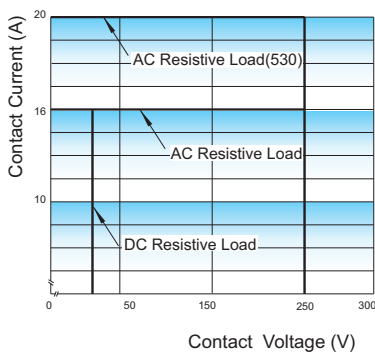

ENDURANCE CURVE

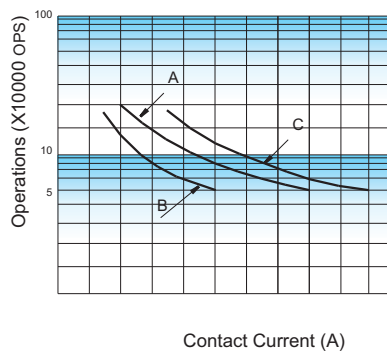

COIL TEMPERATURE RISE

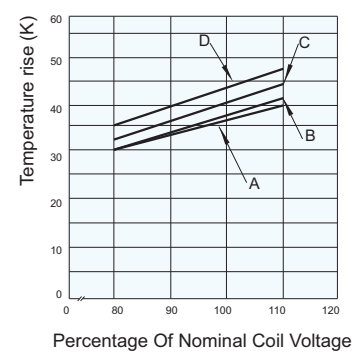

Notes:

- Curve A: HP type
Curve B: H type
Curve C: HP type(530)
- Test conditions:
Curve A: 16A 250VAC, Resistive load, Room temp., 1s on 9s off
Curve B: 10A 250VAC, Resistive load, Room temp., 1s on 9s off
Curve C: 20A 250VAC, Resistive load, Room temp., 1s on 9s off

Notes:

- Test conditions:
A 85°C 16A (HP type)
B 85°C 10A (H Standard type)
C 85°C 20A (HP 530)
D 85°C 10A (Z Standard type)
- Mounting distance: 25mm

Disclaimer

The specification is for reference only. See to "Terminology and Guidelines" for more information. Specifications subject to change without notice. We could not evaluate all the performance and all the parameters for every possible application. Thus the user should be in a right position to choose the suitable product for their own application. If there is any query, please contact Hongfa for the technical service. However, it is the user's responsibility to determine which product should be used only.

© Xiamen Hongfa Electroacoustic Co., Ltd. All rights of Hongfa are reserved.