

MC-19AA-XXX-H-1208-B COB Series Datasheet

Applications

- Spot lighting
- Par 20/30/38
- Down lighting
- Recessed fixtures
- Can lighting

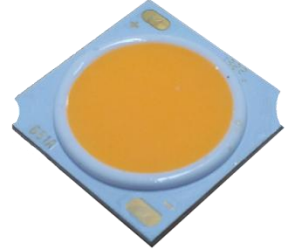

Naming Conventions

MC-19AA - XXX - H - 1208 - B
 (1) (2) (3) (4)

- (1) COB Series
- (2) CCT Range
- (3) CRI Range
- (4) Chip Array: 12 series, 8 parallel

Package Dimensions

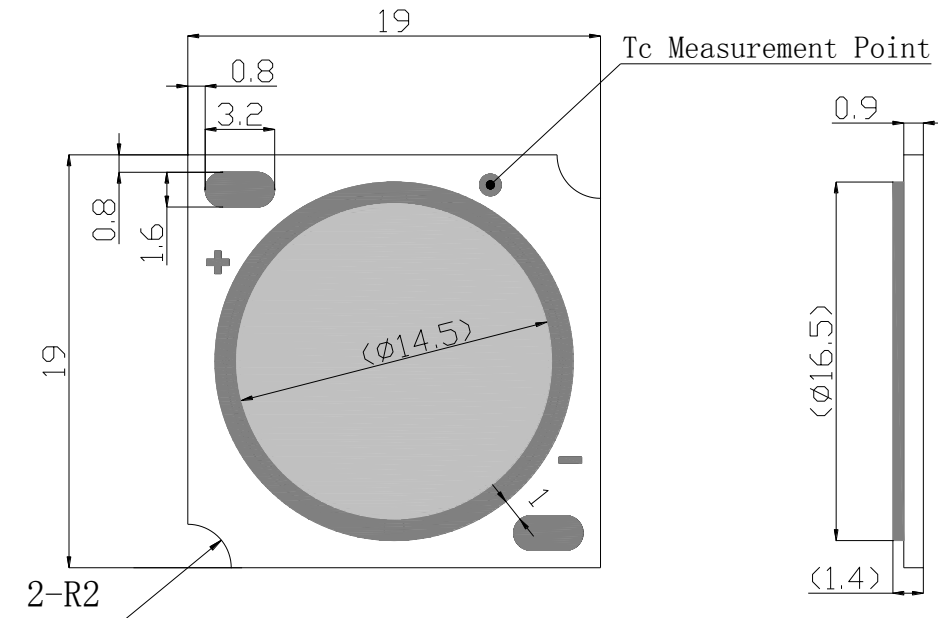

1. All dimensions in millimeters.
2. Tolerance is +/-0.3mm unless otherwise noted.
3. The information in this document is subject to change without notice.

Absolute Maximum Ratings

Item	Symbol	Absolute Maximum Rating	Unit
Forward current	If	1840	mA
Peak Power	-	64.4	W
Reverse Current	Ir	1	mA
Operating Temperature	Topr	-30~85	°C
Storage Temperature	Tstg	-40~100	°C
Hand soldering condition	Tsld	3.5sec@350°C	sec
Case Temperature	Tc	100	°C
LED Junction Temperature	Tj	125	°C
Temperature of central silicon Surface	Ts	125@IRDA Test	°C

Characteristics (Tc=25°C)

Part Number	Nominal CCT	CRI(Ra)		Luminous flux (lm)		Forward Current (mA)	Voltage (V)			Thermal Resistance Rj-c (°C/W)
		Min.	Typ.	Min.	Typ.		Min.	Typ.	Max.	
MC-19AA-270-H-1208-B	2700K	80	82	4223	4693	960	33.6		40.8	0.71
MC-19AA-300-H-1208-B	3000K			4446	4940					
MC-19AA-400-H-1208-B	4000K			4579	5088					
MC-19AA-500-H-1208-B	5000K			4712	5236					
MC-19AA-570-H-1208-B	5700K			4734	5261					

Notes:

- Luminous flux is measured with an accuracy of +/- 5 %.
- CRI is measured with an accuracy of +/- 1
- Some color and CRI bins may have limited availability, please contact us before ordering.
- All measurements were made under the standardized environment of Shineon.

Chromaticity Characteristics (Tc=25°C, If=960mA)

X-y chart CIE1931

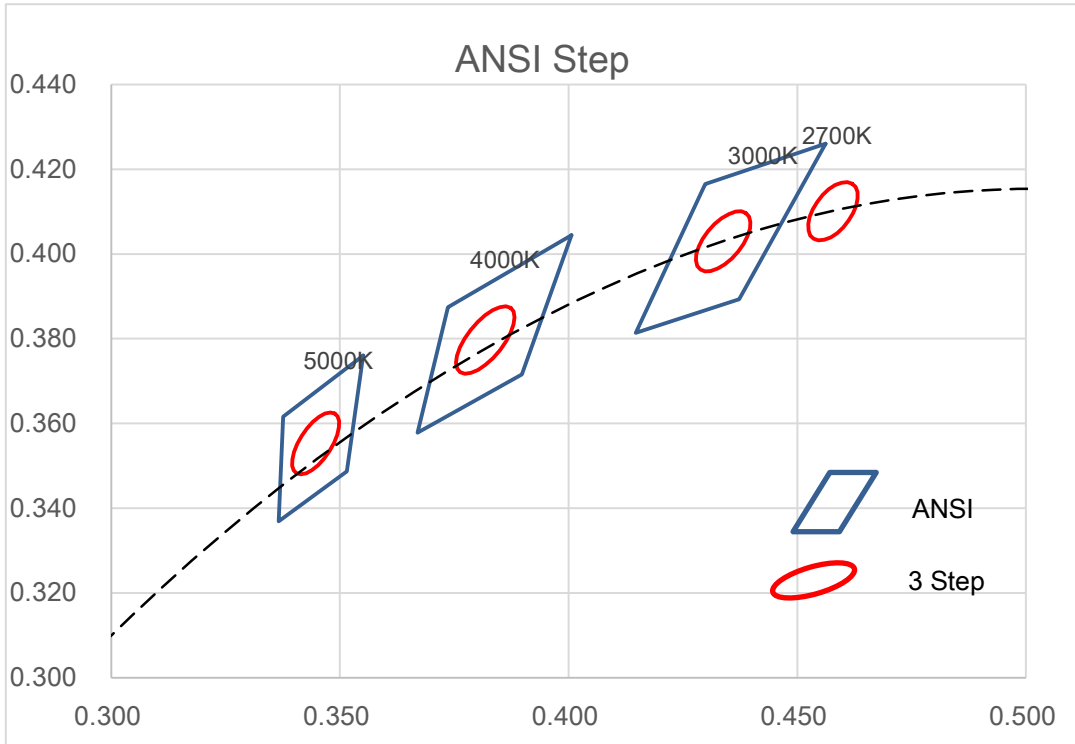

Bin Code	Nominal CCT	Center Point		Oval parameter		
		x	y	a	b	Theta°
273	2700K (3-step)	0.4578	0.4101	0.00774	0.00411	57.28
303	3000K (3-step)	0.4338	0.403	0.00834	0.00408	53.17
403	4000K (3-step)	0.3818	0.3797	0.0094	0.004	54
503	5000K (3-step)	0.3447	0.3553	0.00822	0.00354	59.62

Notes:

1. The chromaticity center refers to ANSI C78.377:2008
2. 5% tolerance for luminous intensity may be caused by measurement inaccuracy.
3. Measurement Uncertainty of the Forward Voltage : +/- 3%.
4. Chromaticity coordinate bins are measured with an accuracy of +/- 0.005.

Chromaticity Bins (ANSI)

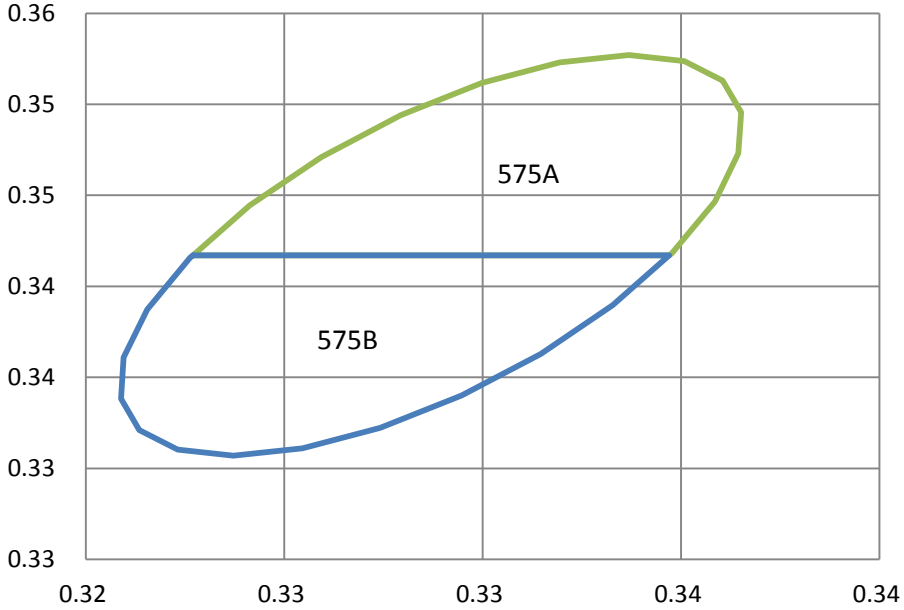

BIN CODE	CCT	Color Coordinates (x, y)				
		Center		Oval parameter		
575A	5700K (5-step)	x	y	a	b	Theta°
			0.3287	0.3417	0.01243	0.00533
575B	5700K (5-step)	Cutting line			x	y
				Point1	0.3227	0.3417
				Point2	0.3347	0.3417

Notes:

1. 5% tolerance for luminous intensity may be caused by measurement inaccuracy.
2. Measurement Uncertainty of the Forward Voltage : +/-3%
3. Chromaticity coordinate bins are measured with an accuracy of +/-0.005.

Typical Relative Spectral Power Distribution (Tc=25°C, If=960mA)

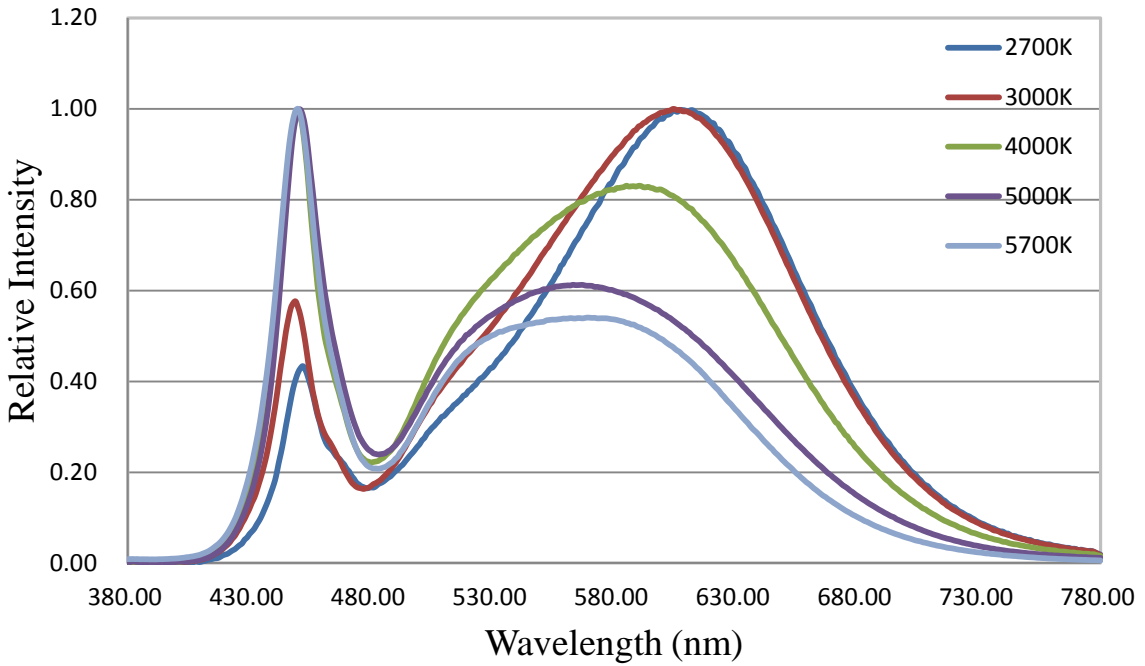

Typical Spatial Distribution (Tc=25°C, If=960mA)

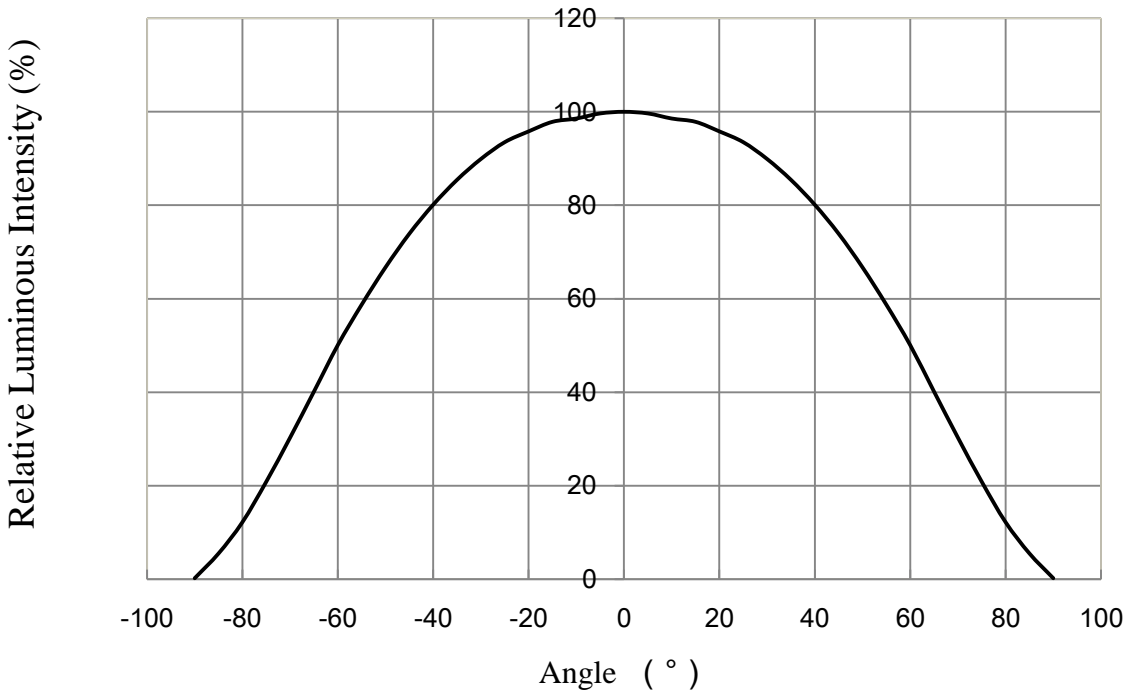

Forward Current vs. Forward Voltage
($T_c=25^\circ\text{C}$)

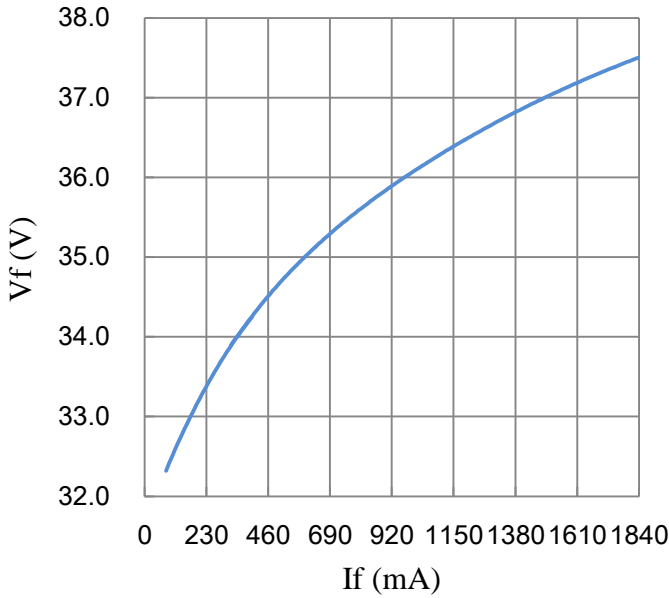

Forward Current vs. Relative Luminous Flux
($T_c=25^\circ\text{C}$)

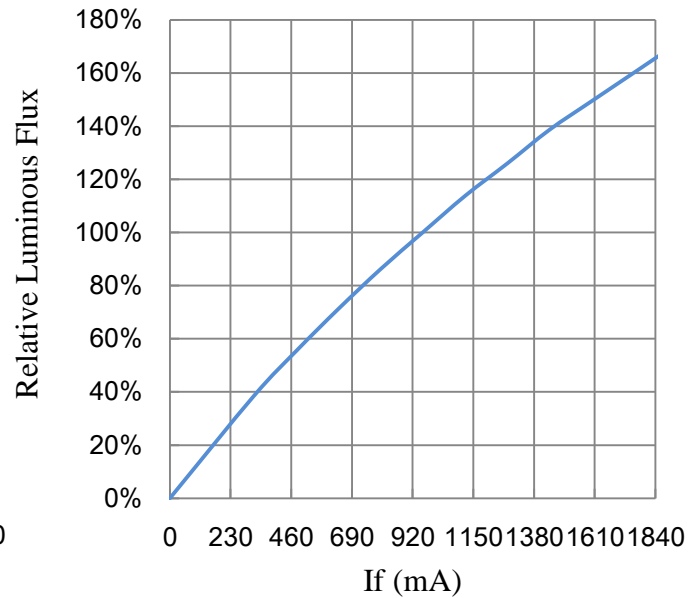

Case Temperature vs. Forward Voltage
($I_f=960\text{mA}$)

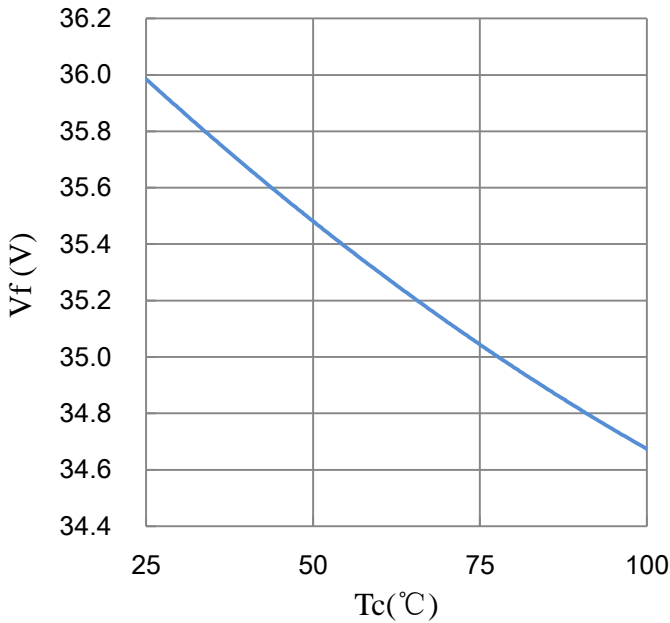

Case Temperature vs. Relative Radiant Flux
($I_f=960\text{mA}$)

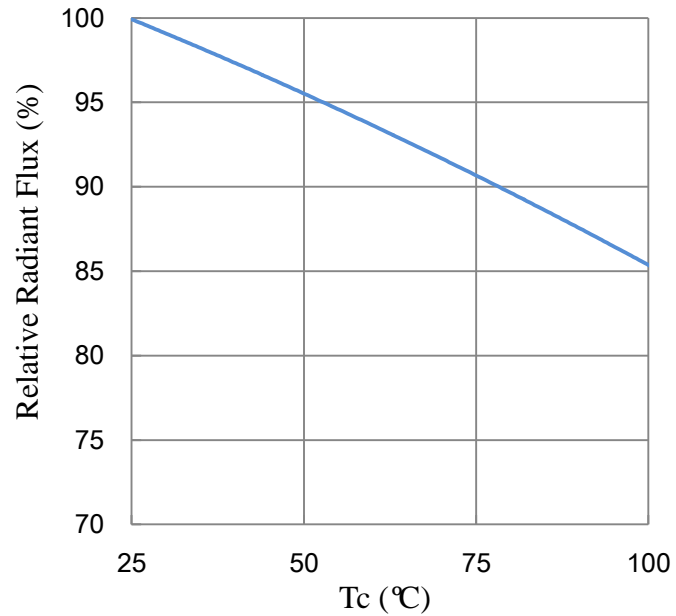

Case Temperature vs. Allowable Forward Current

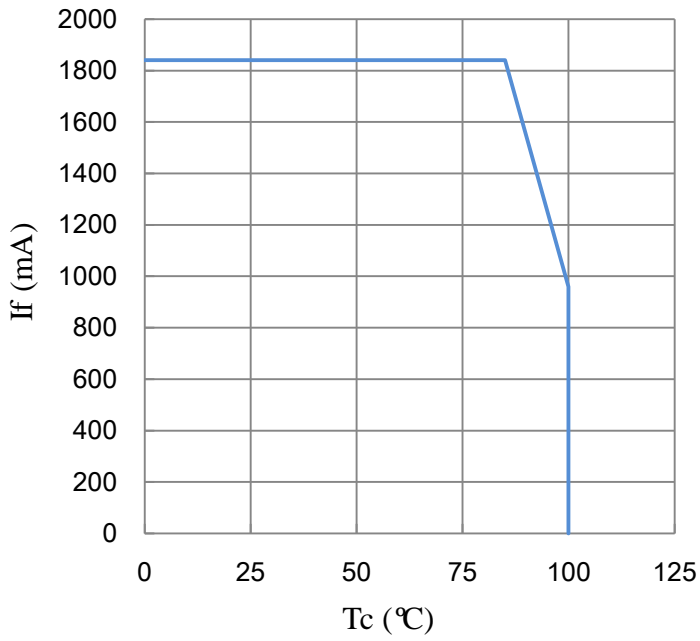

Reliability

(1)Details of the tests

No.	Test Item	Reference Standard	Test Condition	Test Duration	Defective	Sample Size
1	High Temperature Operating Life	JESD22-A108	Tc=85℃, Typical IF	1000hr	0	10
2	Low Temperature Operating Life	JESD22-A108	Ta=-40℃, Typical IF	1000hr	0	10
3	Temperature Shock	MIL-STD-202G Method 107G	-40℃ ∞ 100℃	100cycles	0	10
4	High Temperature Storage	JESD22-A103	100℃	1000hr	0	10
5	Temperature Humidity Storage	JEITA ED-4701 100 103	60℃, 90%RH	1000hr	0	10

(2)Judgment Criteria of Failure for Reliability Test

(Ta=25℃)

NO.	Measuring Item	Symbol	Measuring Condition	Judgment Criteria for Failure
1	Forward Voltage	Vf	If=960mA	>U X 1.1
2	Total Luminous Flux	∅v	If=960mA	<S X 0.85

Notes:

U defines the upper limit of the specified characteristics. S defines the initial value.

PACKING

COB 19AA

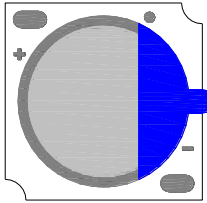

COB 19AA

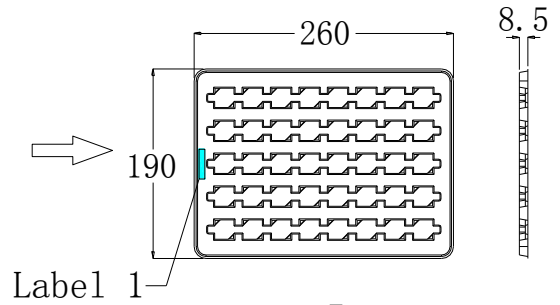
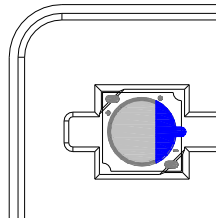

Protective film on LES 40 pcs of device per tray

6 trays in an anti-static bag, with one empty tray on top.
The set of 6 trays is packed up with a vacuum bag.

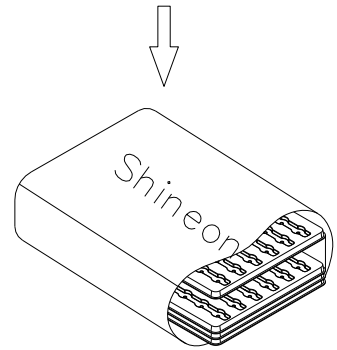

7 bags per box

Notes:

Remove the protective film before use in the first time.

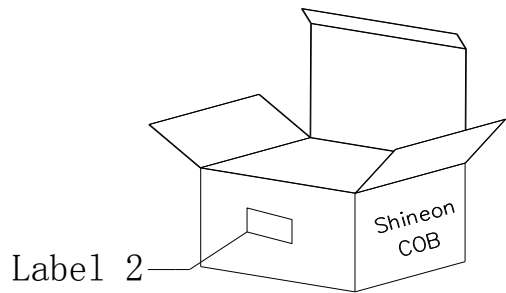

1400 pcs of device per box